



US00D405345S

# United States Patent [19]

Hankel et al.

[11] Patent Number: **Des. 405,345**

[45] Date of Patent: **\*\*Feb. 9, 1999**

[54] **MAGNETIC CARD READER AND DOOR KNOB ASSEMBLY**

[75] Inventors: **Willi Hankel, Waldeck; Bernd Steltner, Volkmarsen; Winfried Scholl, Düsseldorf, all of Germany**

[73] Assignee: **HEWI Heinrich Wilke GmbH, Arolsen, Germany**

[\*\*] Term: **14 Years**

[21] Appl. No.: **55,872**

[22] Filed: **Jun. 14, 1996**

### Related U.S. Application Data

[62] Division of Ser. No. 43,447, Aug. 25, 1995, Pat. No. Des. 382,790.

### [30] Foreign Application Priority Data

Feb. 25, 1995 [DE] Germany ..... 95 01 667.8  
Feb. 25, 1995 [DE] Germany ..... 95 01 665.1

[51] **LOC (6) Cl.** ..... **08-07**

[52] **U.S. Cl.** ..... **D8/331**

[58] **Field of Search** ..... D8/330-331, 343, D8/341, 350, 353, 300, 301, 302, 306; 70/91, 101, 102, 104, 106, 107, 158, 277, 278, 279, 287, 288

### [56] References Cited

#### U.S. PATENT DOCUMENTS

D. 288,899 3/1987 Floyd et al. .... D8/330

D. 305,861 2/1990 Kautt ..... D8/3  
D. 313,159 12/1990 Kautt ..... D8/331 X  
D. 360,124 7/1995 Gartner ..... D8/330  
D. 366,822 2/1996 Brooks et al. .... D8/330  
4,227,388 10/1980 Nigrelli et al. .... 70/277  
4,232,353 11/1980 Musciati et al. .... 70/277

*Primary Examiner*—Brian N. Vinson  
*Attorney, Agent, or Firm*—Michael J. Striker

### [57] CLAIM

The ornamental design for a magnetic card reader and door knob assembly, as shown and described.

### DESCRIPTION

FIG. 1 is a front elevational view of a magnetic card reader and door knob assembly showing our new design;

FIG. 2 is a left side elevational view thereof, the right side being a mirror image of that shown;

FIG. 3 is a top plan view thereof;

FIG. 4 is a top plan view thereof;

FIG. 5 is a front elevational view of a magnetic card reader and door knob assembly showing a second embodiment of our new design;

FIG. 6 is a left side elevational view thereof, the right side being a mirror image of that shown;

FIG. 7 is a top plan view thereof; and,

FIG. 8 is a top plan view thereof.

**1 Claim, 2 Drawing Sheets**

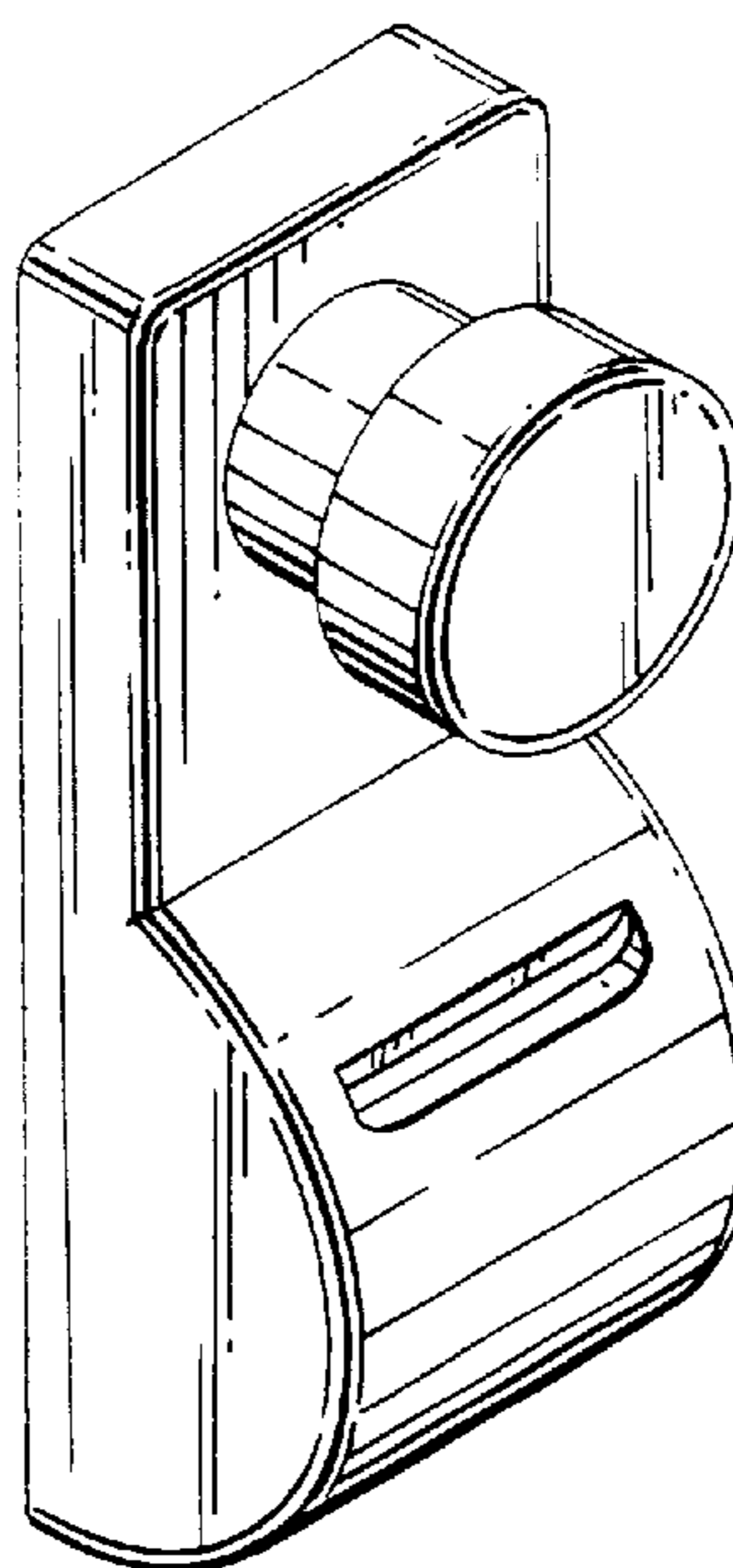
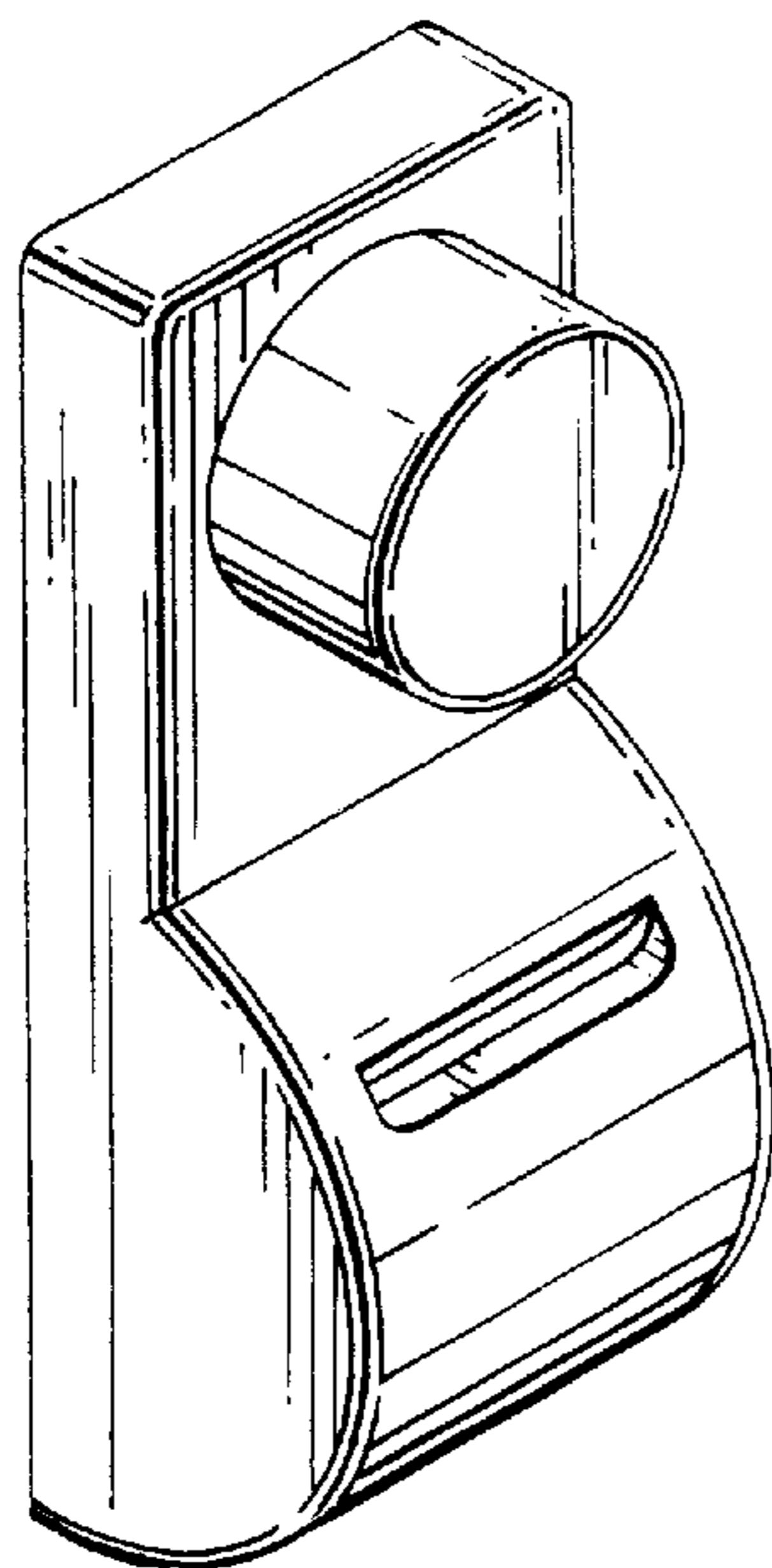

Fig. 1

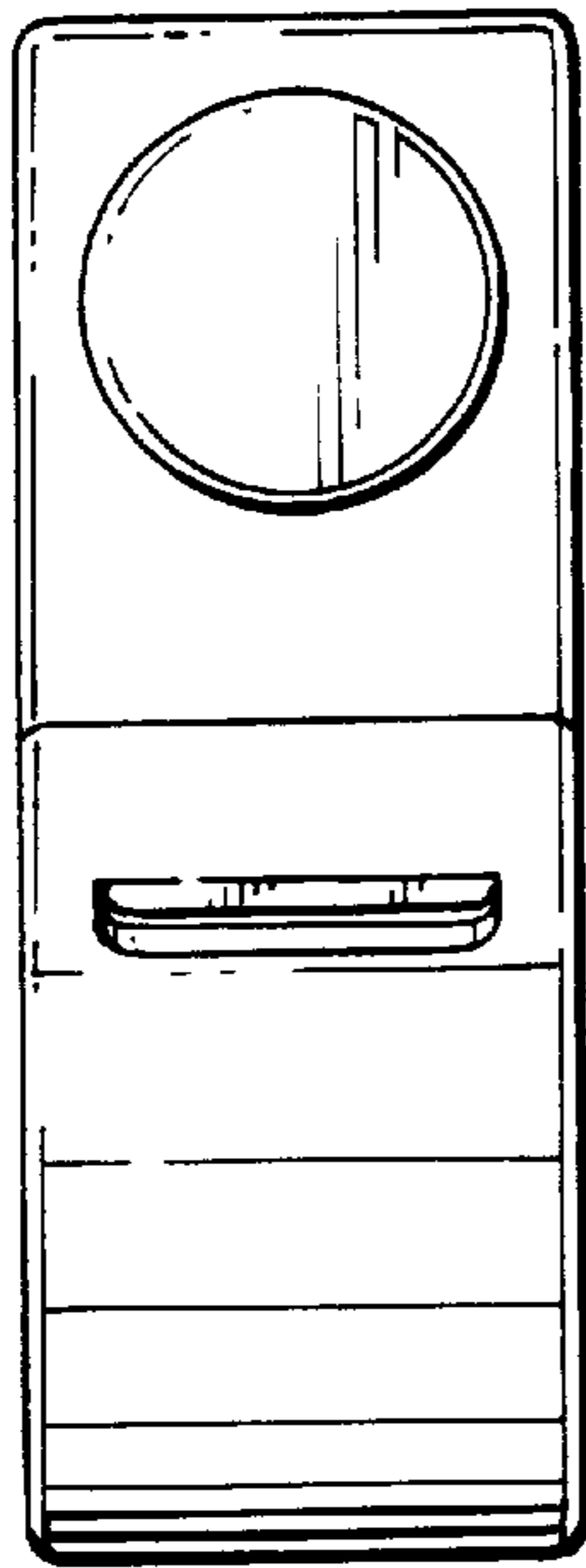

Fig. 2

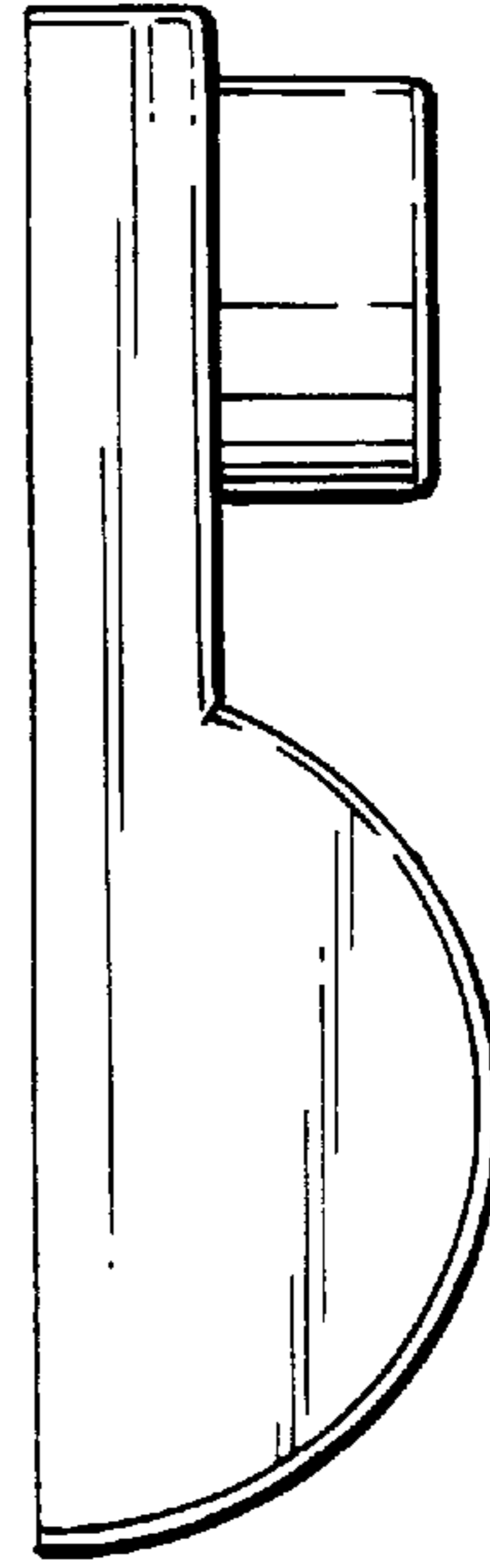

Fig. 3

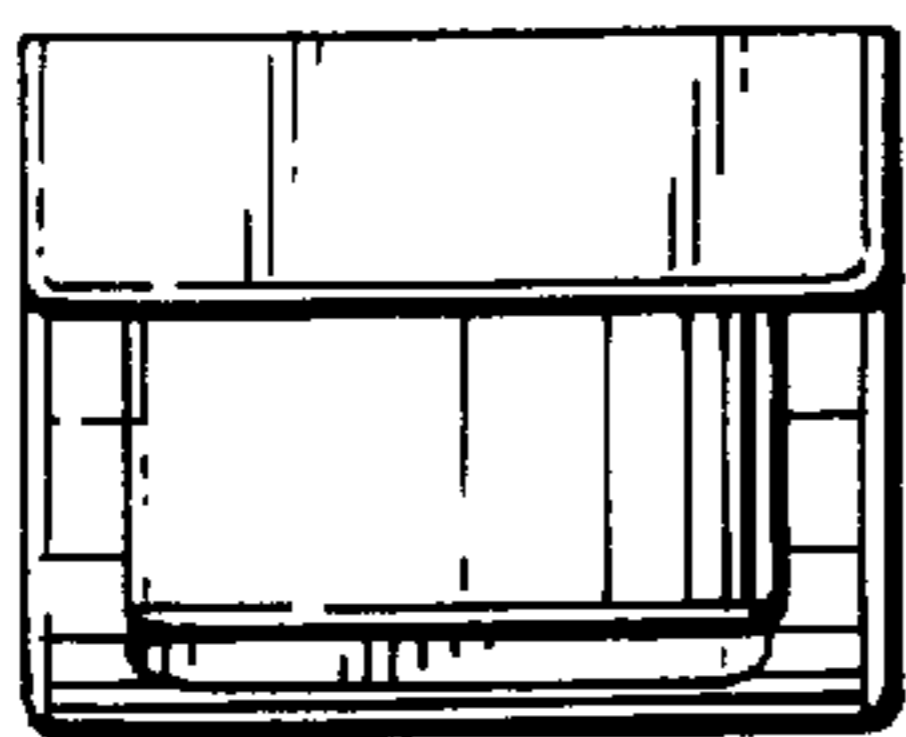

Fig. 4

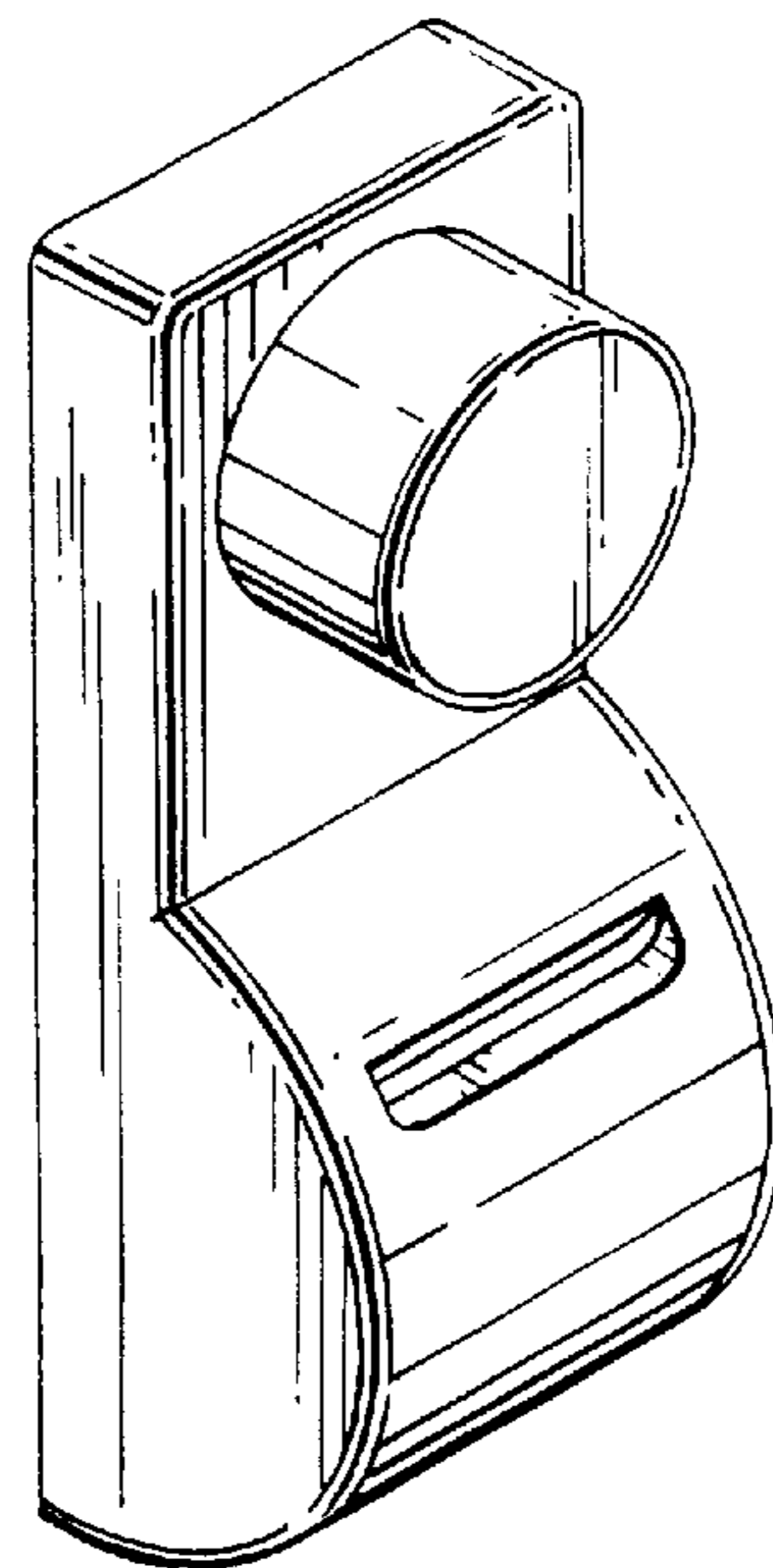

Fig.5

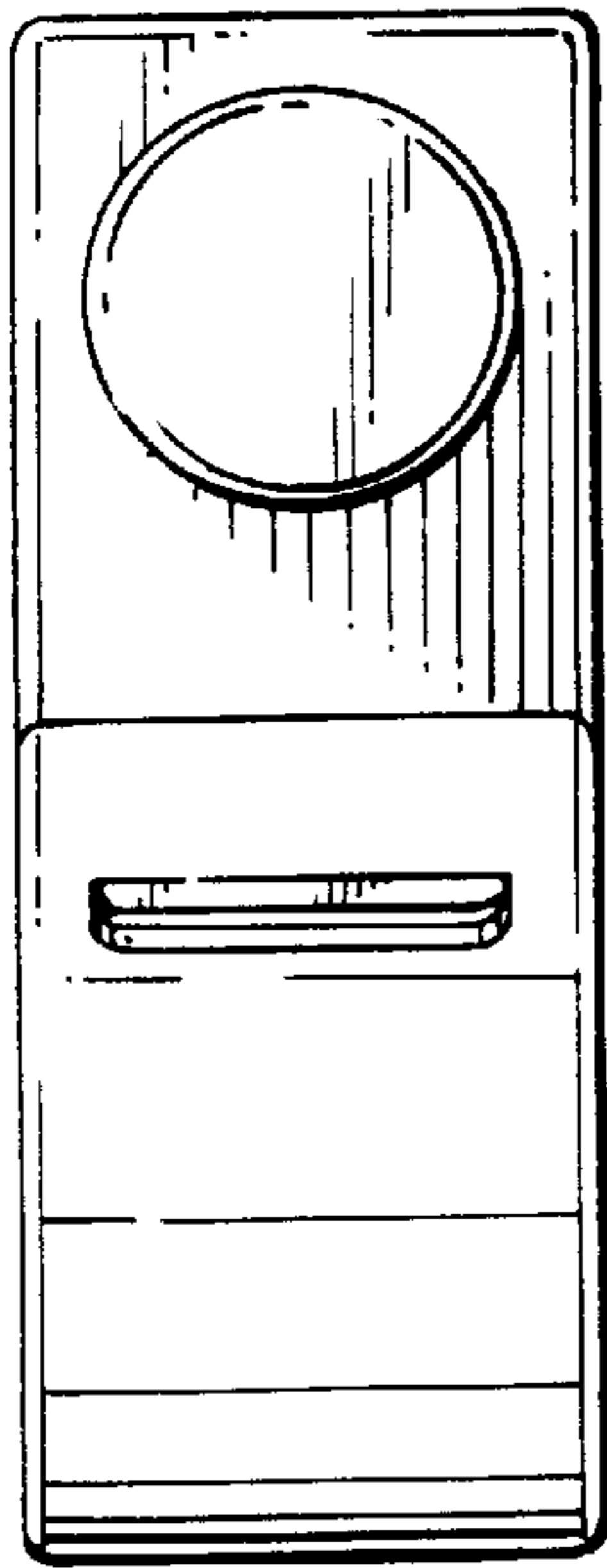

Fig.6

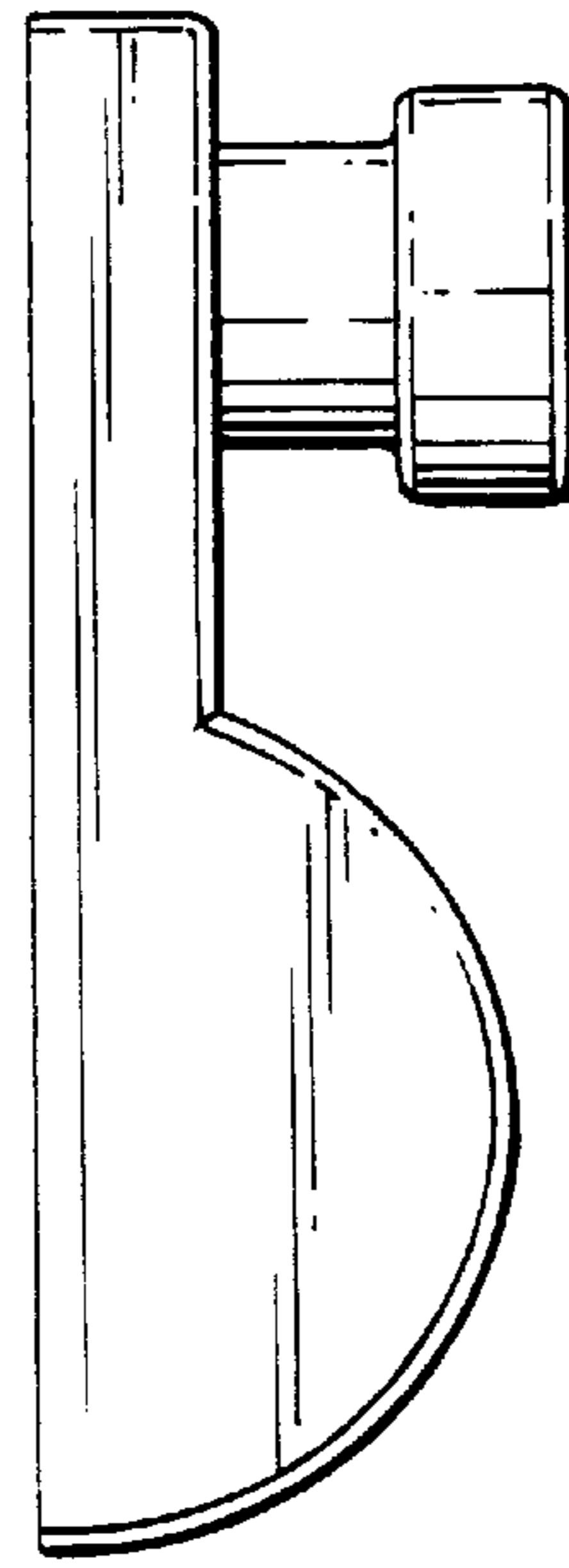

Fig.7

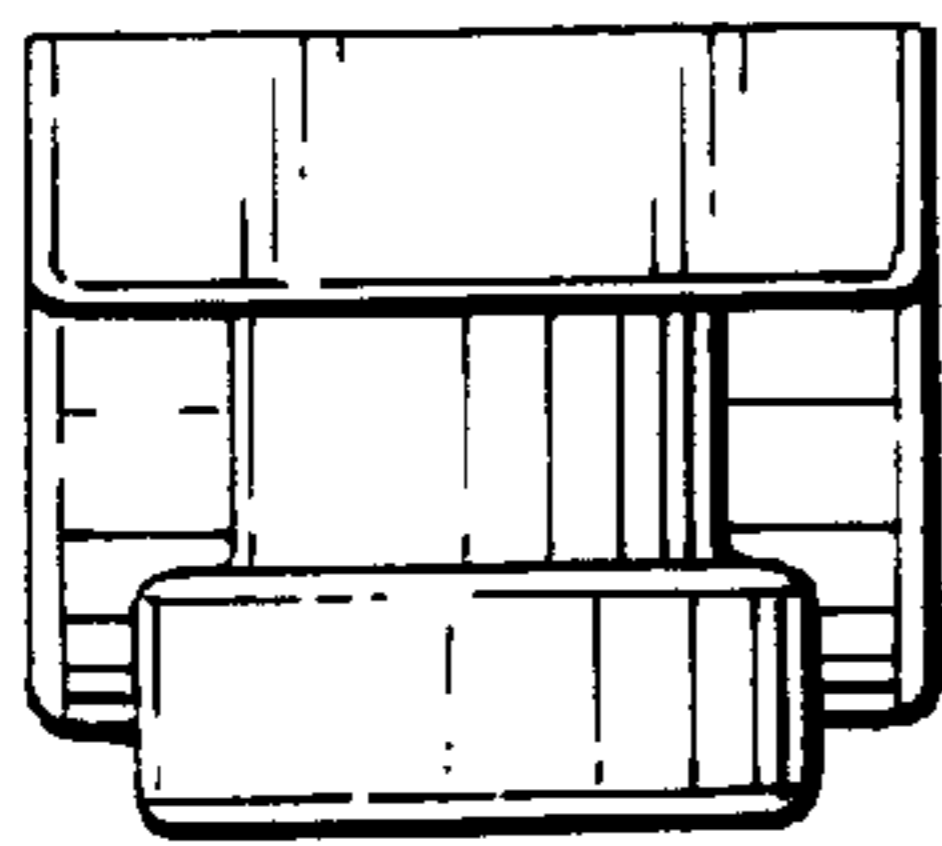

Fig.8

