



US00D405291S

United States Patent [19]
Yu

[11] **Patent Number: Des. 405,291**

[45] **Date of Patent: **Feb. 9, 1999**

[54] **INFLATABLE TABLE**

[76] Inventor: **Shan-Lin Yu**, 6F, No. 104, Sec. 2,
An-Ho Rd., Taipei City, Taiwan

[**] Term: **14 Years**

[21] Appl. No.: **88,951**

[22] Filed: **Jun. 4, 1998**

[51] **LOC (6) Cl. 06-06**

[52] **U.S. Cl. D6/406.5; D6/406.6**

[58] **Field of Search** D7/552.1, 552.2,
D7/553.1, 553.3, 553.2, 553.4, 698, 555;
D6/406.1, 406.2, 406.3, 406.4, 406.5, 406.6,
419, 420, 511, 604; 108/43, 44; 224/926;
383/3, 33, 104; D24/183

[56] **References Cited**

U.S. PATENT DOCUMENTS

- D. 25,786 7/1896 Stoll D24/183
- D. 106,986 11/1937 Manson D6/604
- D. 279,845 7/1985 Holliman D6/406.6 X

- D. 359,862 7/1995 Rousch D6/406.6
- D. 363,857 11/1995 Sussman D7/555 X
- D. 376,928 12/1996 Lorenzana et al. D6/406.5
- 5,005,702 4/1991 Davis et al. D6/406.5 X
- 5,134,930 8/1992 Mei-hwa 108/43 X

Primary Examiner—M. N. Pandozzi
Attorney, Agent, or Firm—Morgan, Lewis & Bockius LLP

[57] **CLAIM**

The ornamental design for inflatable table, as shown and described.

DESCRIPTION

FIG. 1 is a perspective view of inflatable table showing my new design;
FIG. 2 is a front elevational view thereof;
FIG. 3 is a rear elevational view thereof;
FIG. 4 is a left side elevational view thereof;
FIG. 5 is a right side elevational view thereof;
FIG. 6 is a top plan view thereof; and,
FIG. 7 is a bottom plan view thereof.

1 Claim, 4 Drawing Sheets

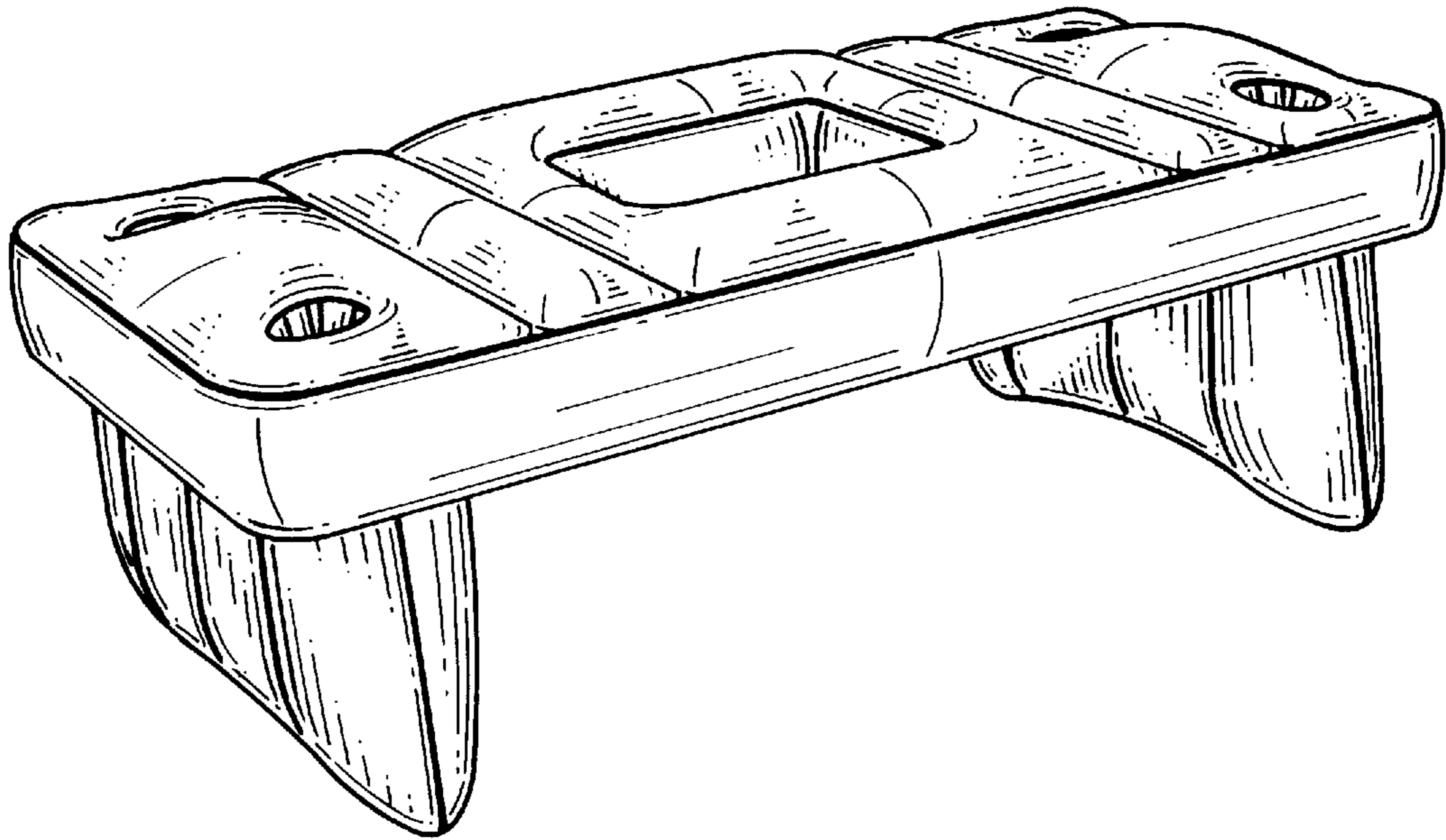

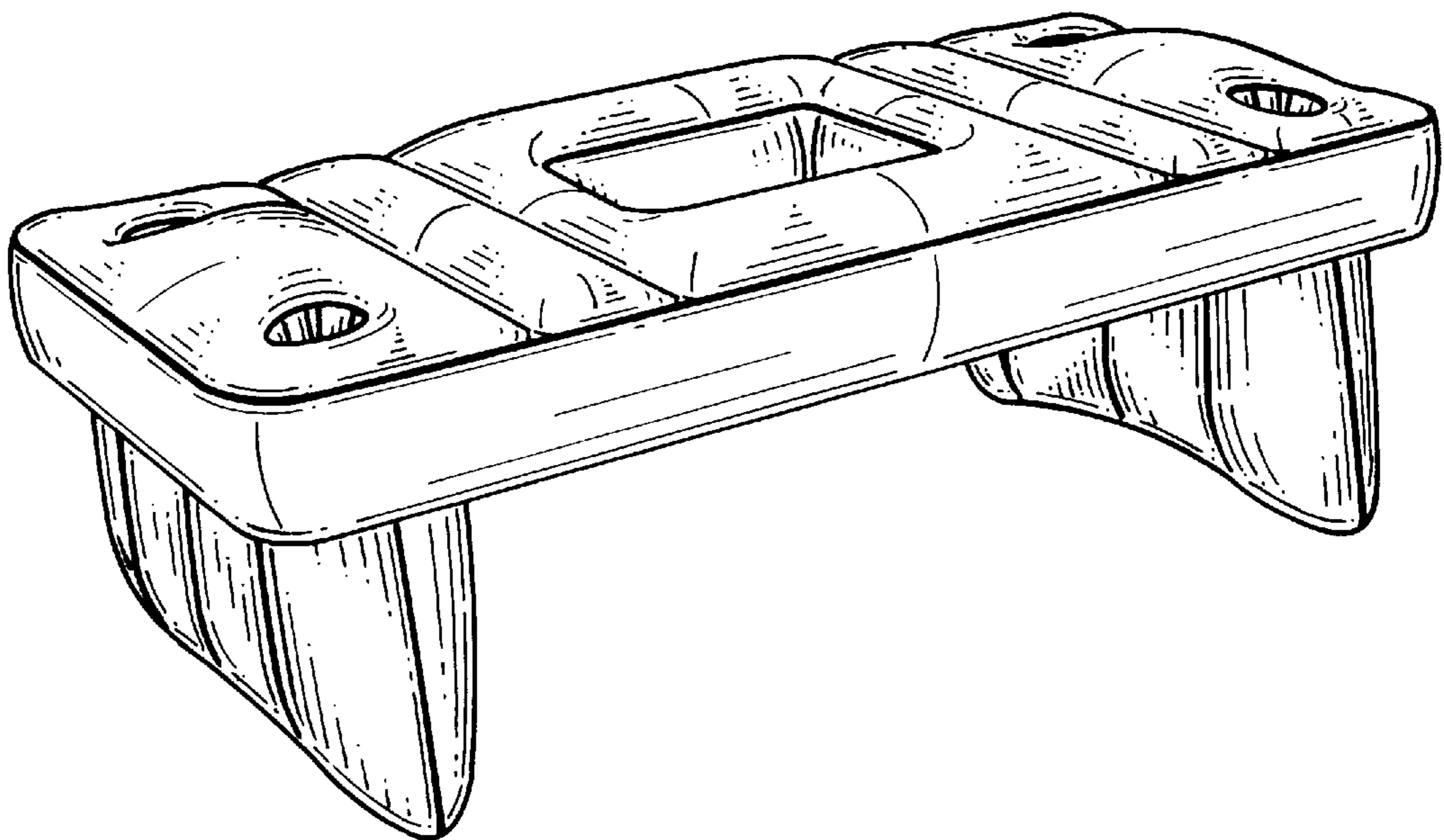

FIG. 1

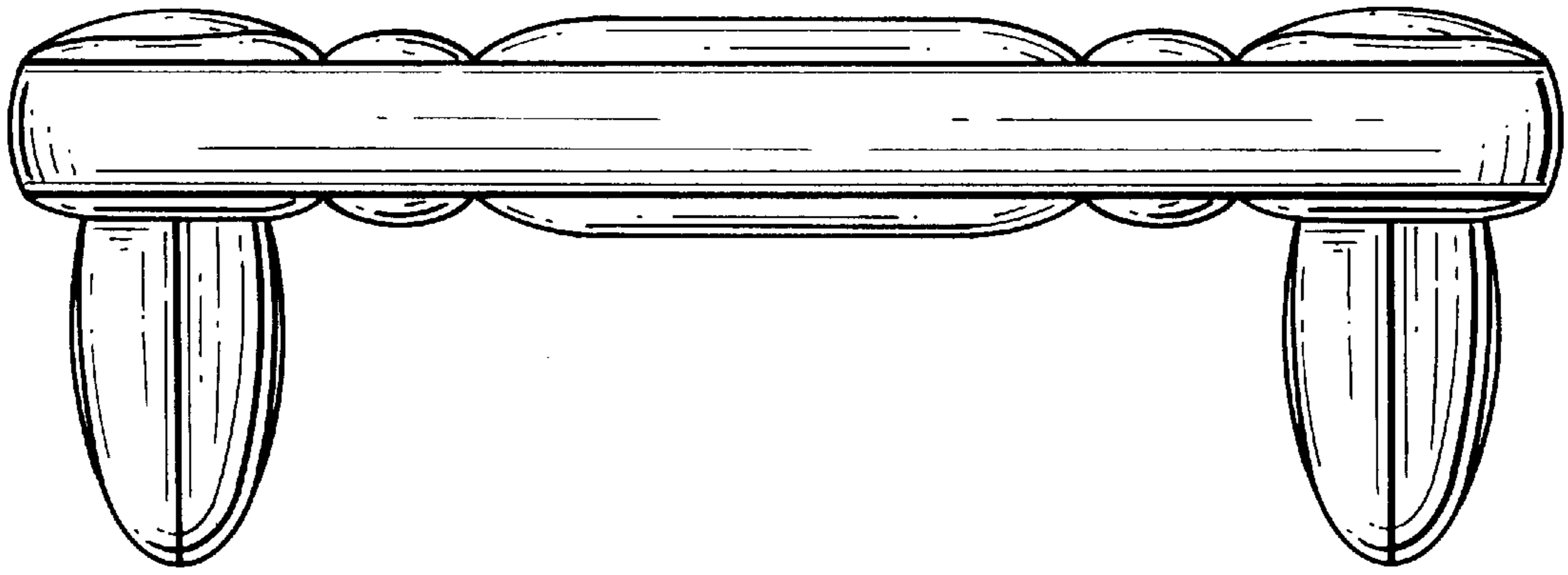

FIG. 2

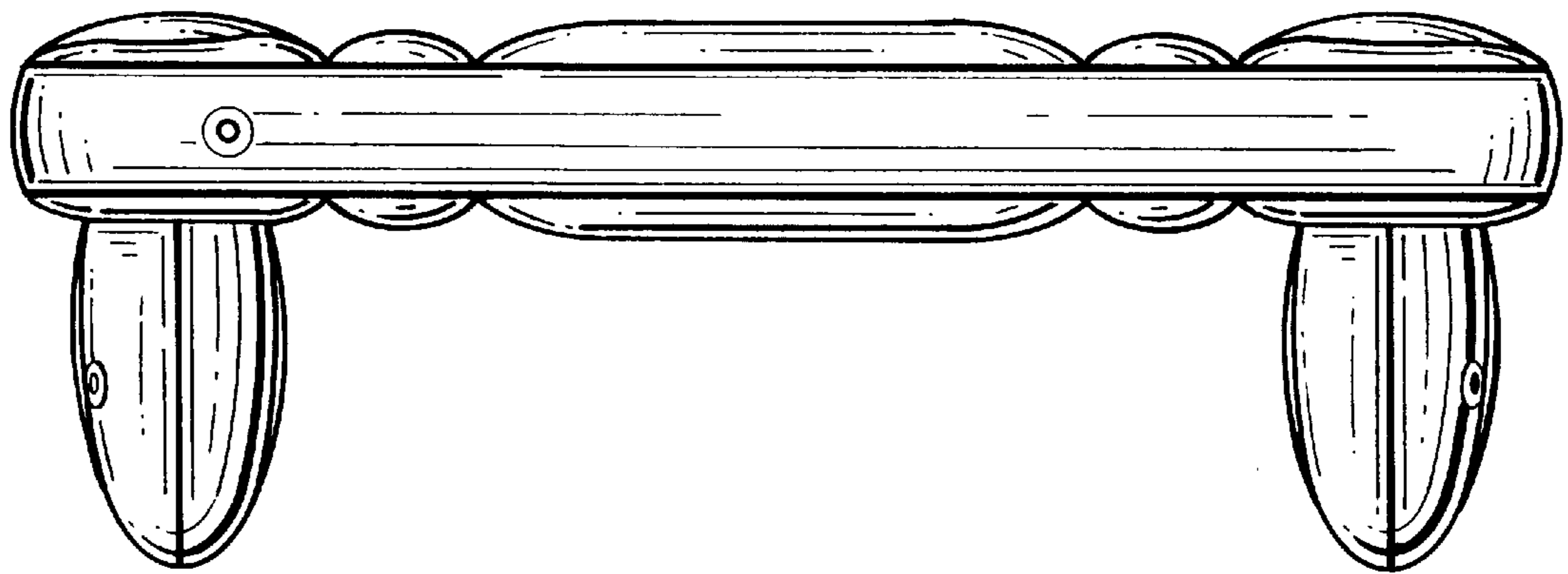

FIG. 3

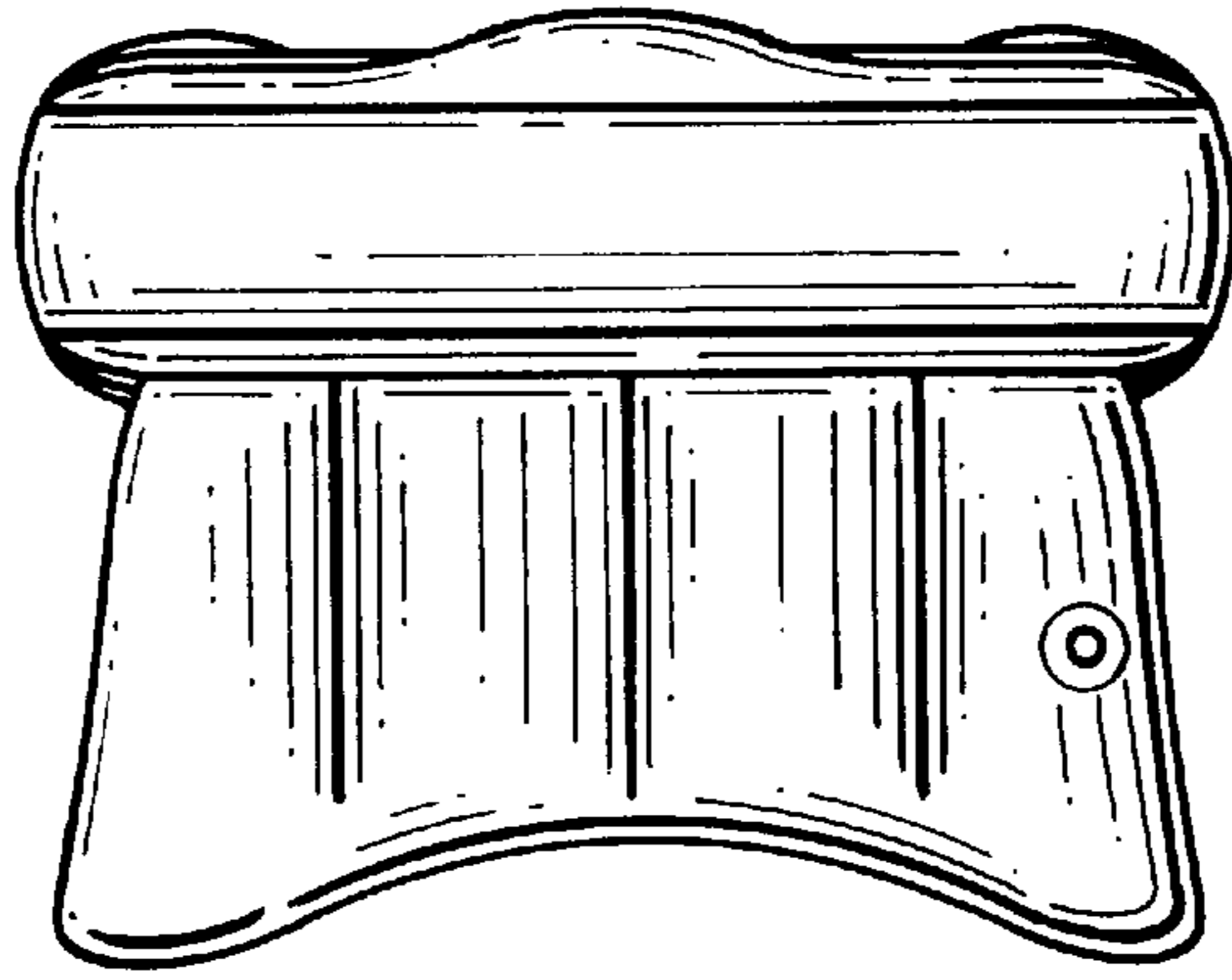

FIG. 4

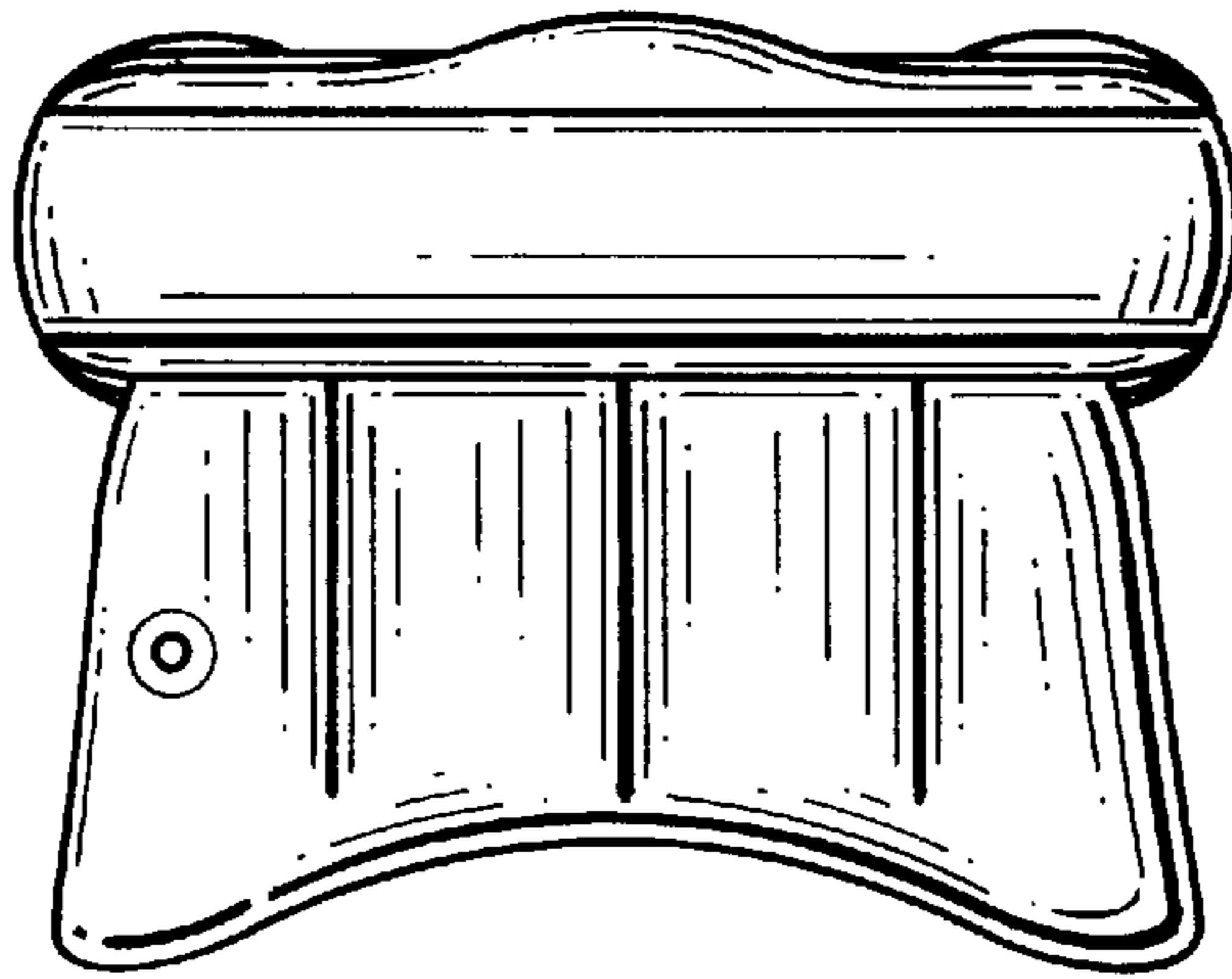

FIG. 5

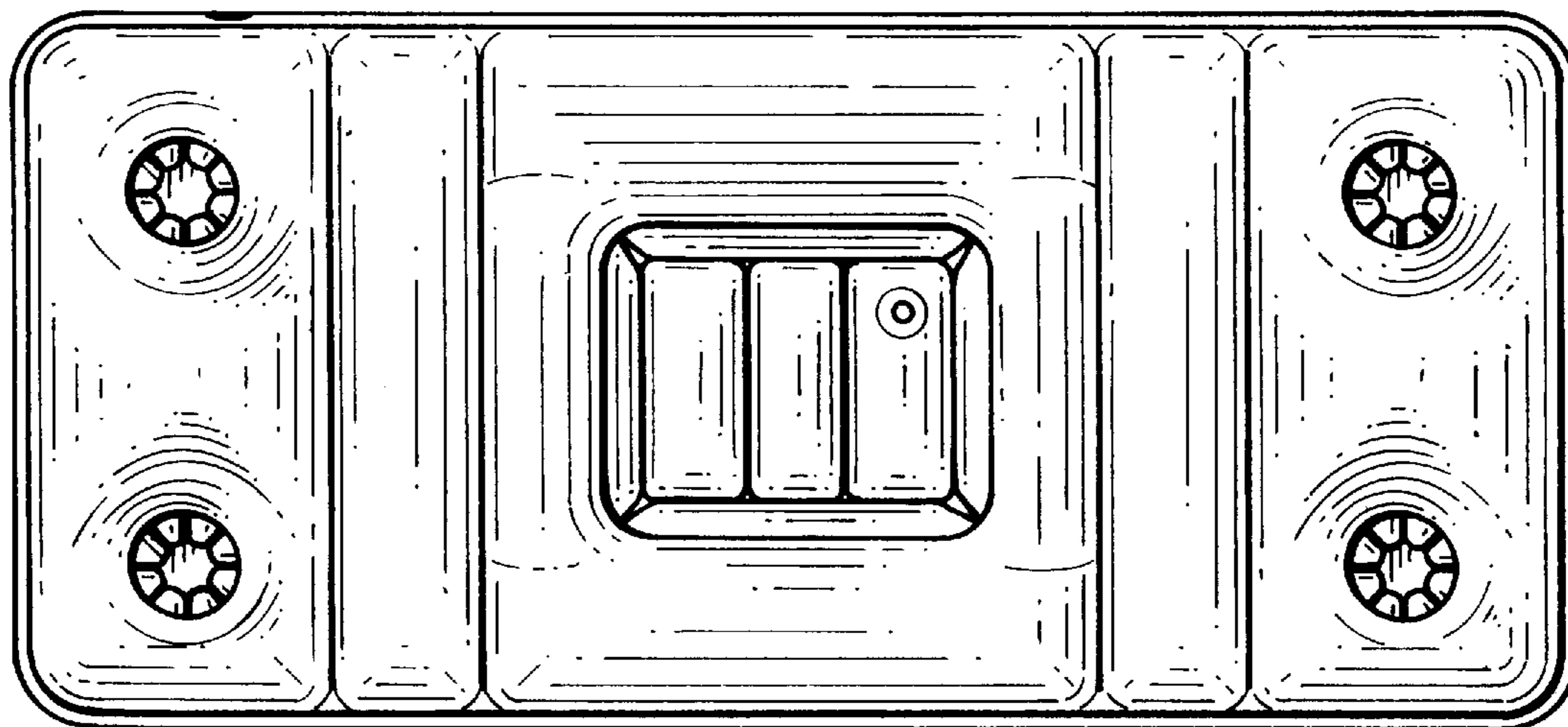

FIG. 6

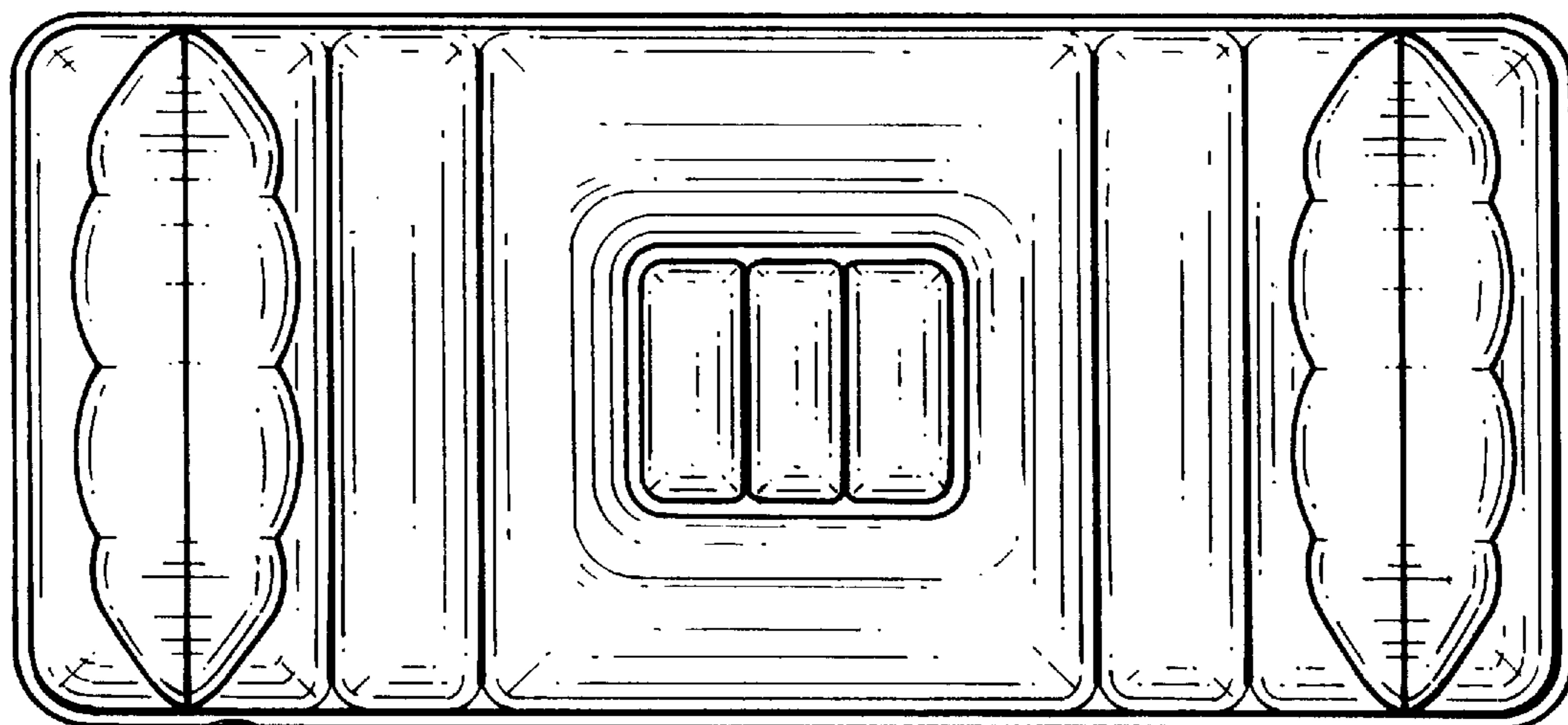

FIG. 7