



US00D405267S

United States Patent [19]
Cowan

[11] **Patent Number:** **Des. 405,267**
[45] **Date of Patent:** ****Feb. 9, 1999**

[54] **POUCH**
[76] Inventor: **Keith Cowan**, 636 Tubman Crescent,
Ottawa, Ontario, Canada, K1V 8L6
[**] Term: **14 Years**
[21] Appl. No.: **82,372**
[22] Filed: **Jan. 21, 1998**
[51] **LOC (6) Cl.** **03-01**
[52] **U.S. Cl.** **D3/303; D3/215; D3/243**
[58] **Field of Search** D3/303, 215, 243;
150/103, 104, 105, 106, 107, 112, 113,
118; 190/102, 108, 109, 111, 902; 206/37;
224/36, 236, 674; 383/40, 66

1,658,997 2/1928 Mulford et al. 190/109
1,689,416 10/1928 Wood 190/109
2,266,334 12/1941 Rice 224/36
2,423,853 7/1947 Ryan 224/36
2,813,669 11/1957 Frieder et al. 224/36

Primary Examiner—Louis S. Zarfaz
Assistant Examiner—Monica A. Weingart
Attorney, Agent, or Firm—Robert G. Hendry

[57] **CLAIM**

The ornamental design for a pouch.

DESCRIPTION

FIG. 1 is a perspective view of the pouch;
FIG. 2 is an end view of the pouch;
FIG. 3 is a front view of the pouch;
FIG. 4 is a view of the back of the pouch;
FIG. 5 is a top view of the pouch;
FIG. 6 is a bottom view of the pouch; and,
FIG. 7 is a perspective view of the pouch showing the cover
in an open position.

[56] **References Cited**
U.S. PATENT DOCUMENTS
99,736 2/1870 Wiler 224/674
D. 354,619 1/1995 Soukeras D3/243 X
D. 362,540 9/1995 McNamara et al. D3/215

1 Claim, 3 Drawing Sheets

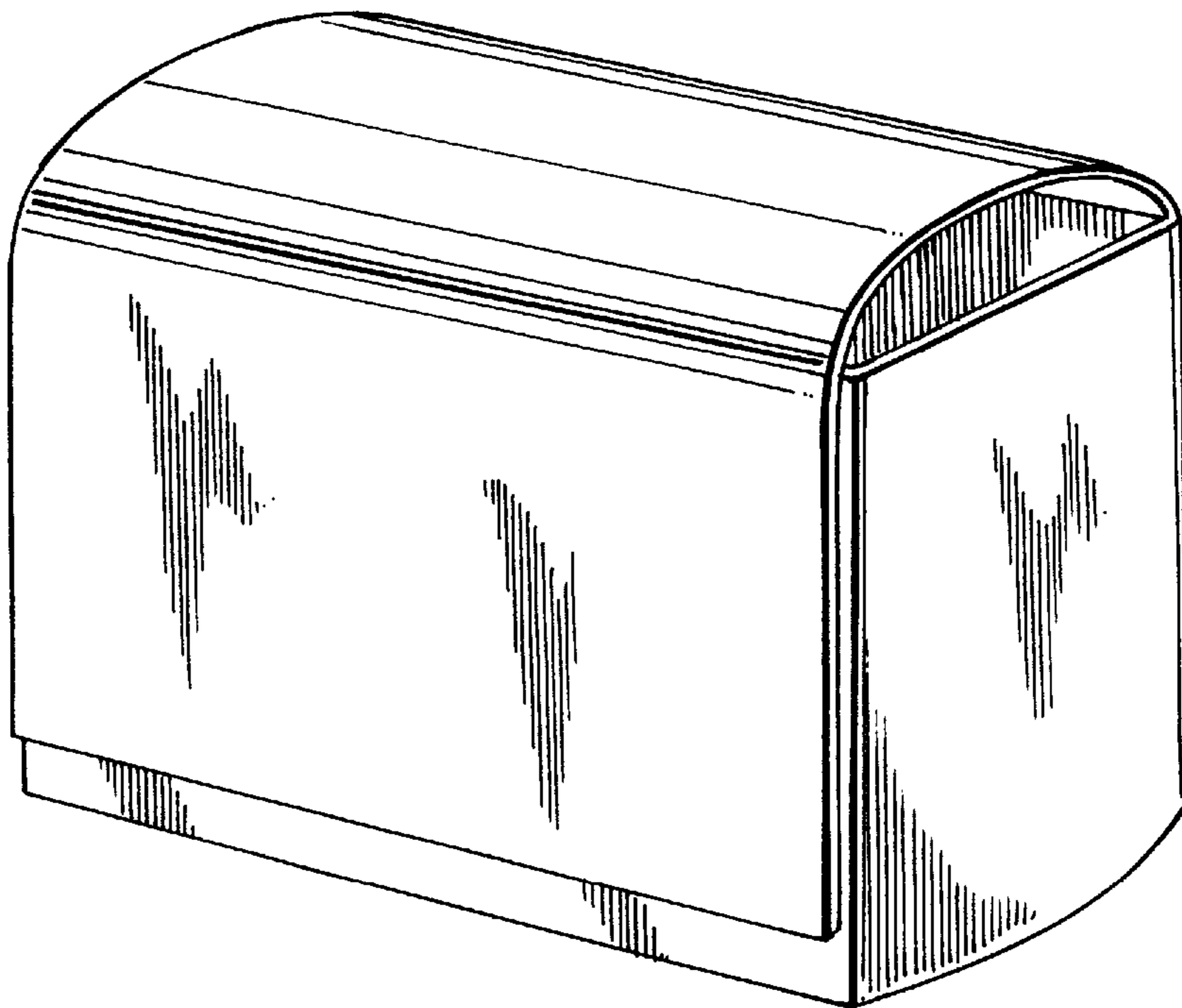

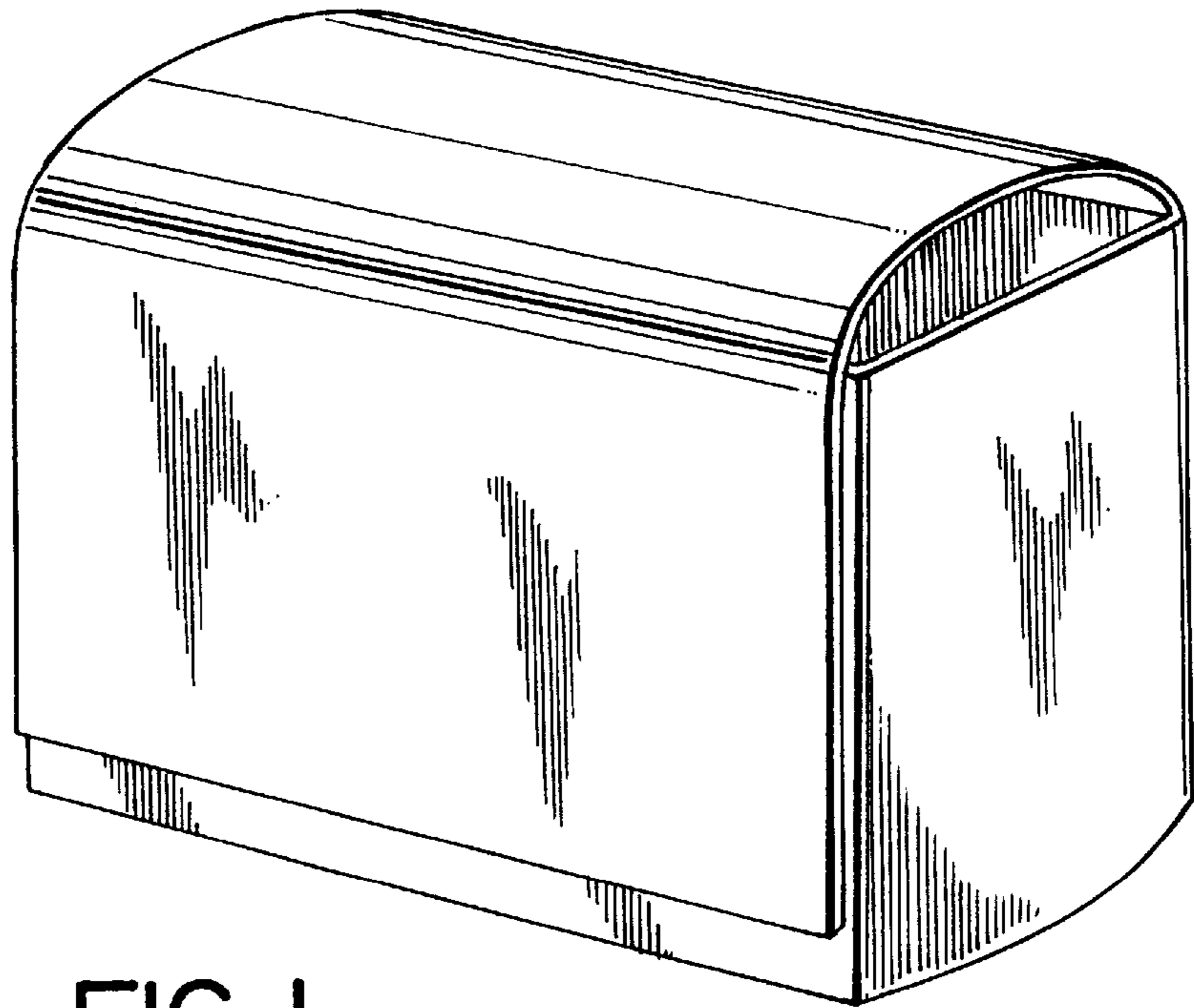

FIG. 1

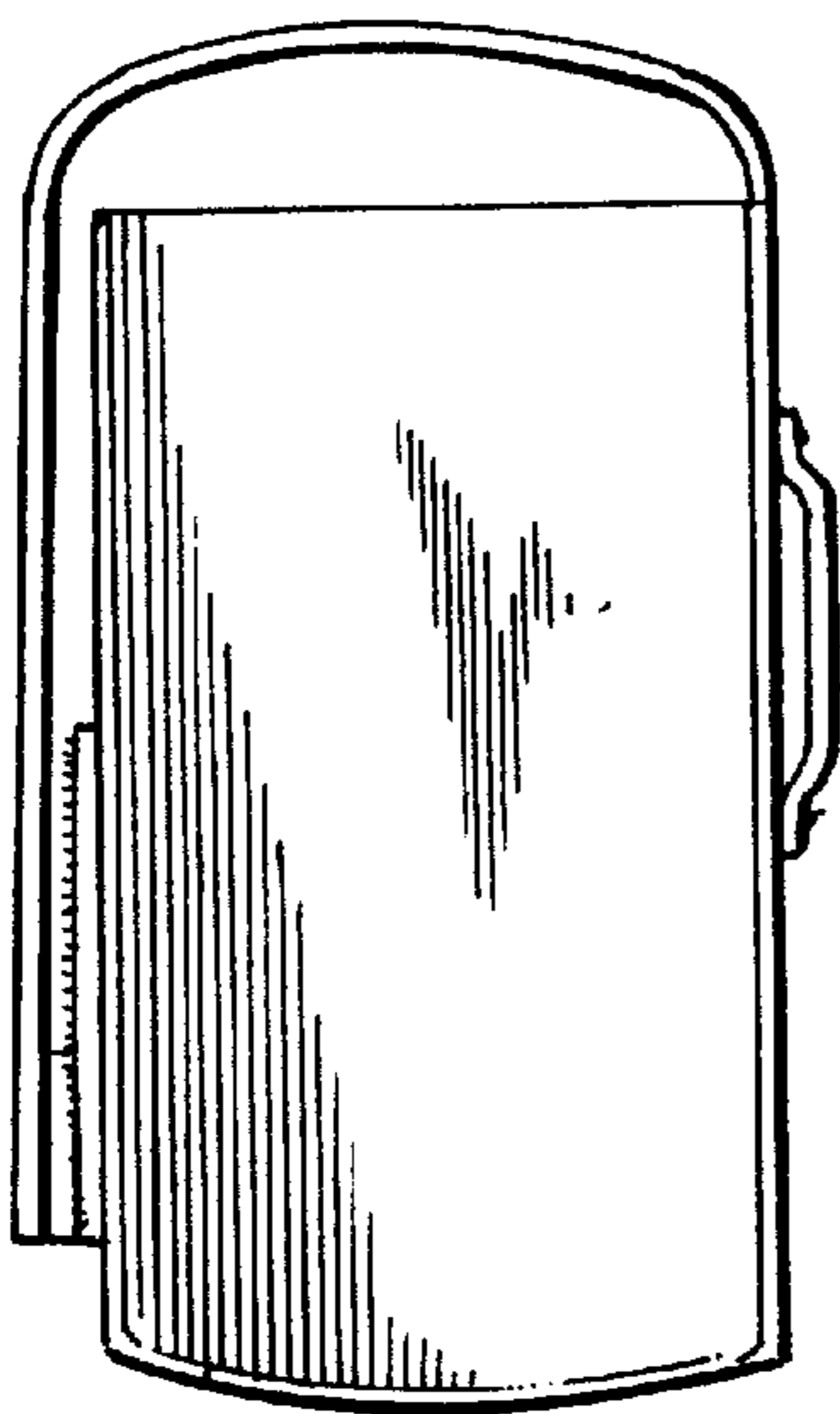

FIG. 2

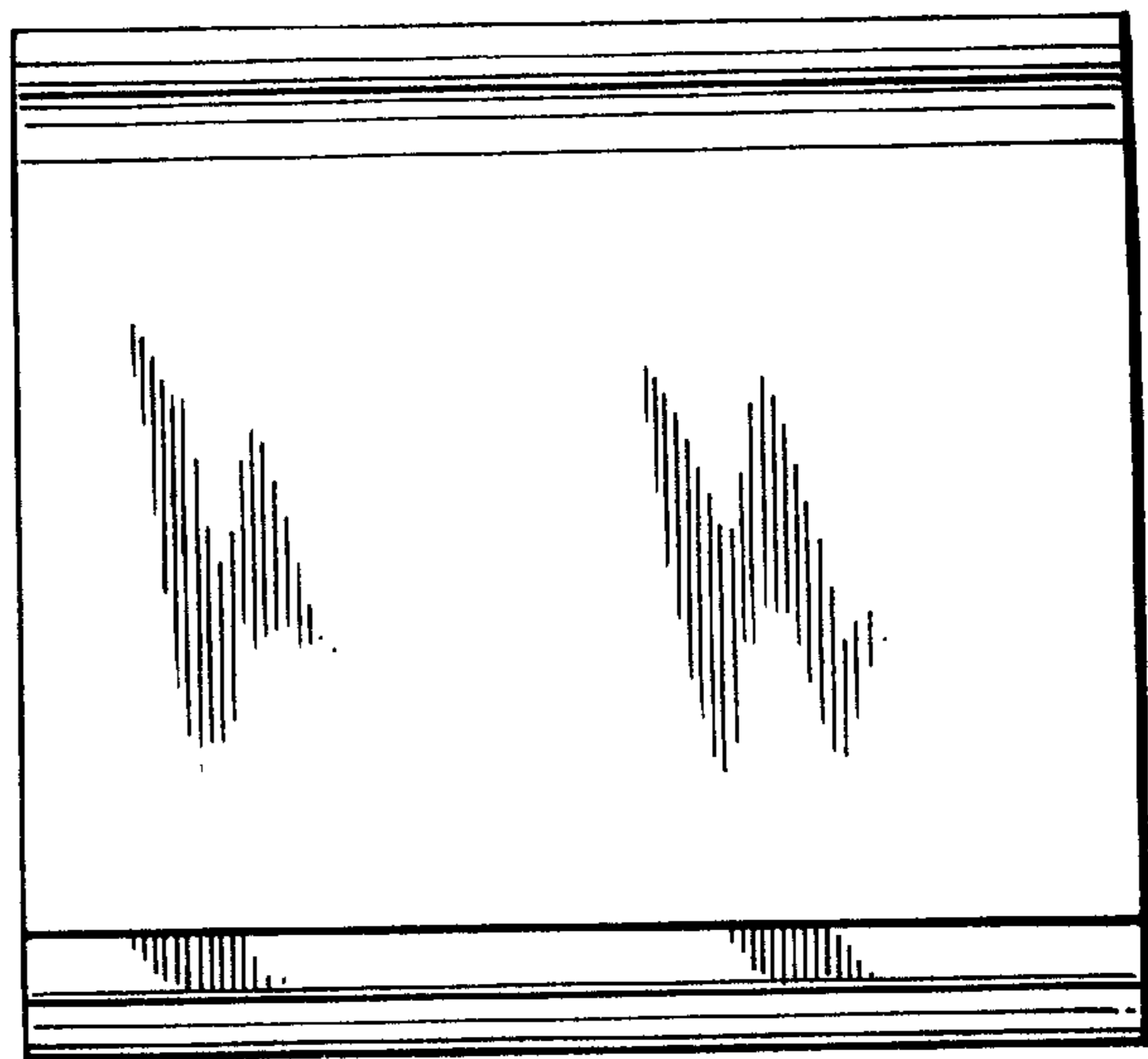

FIG. 3

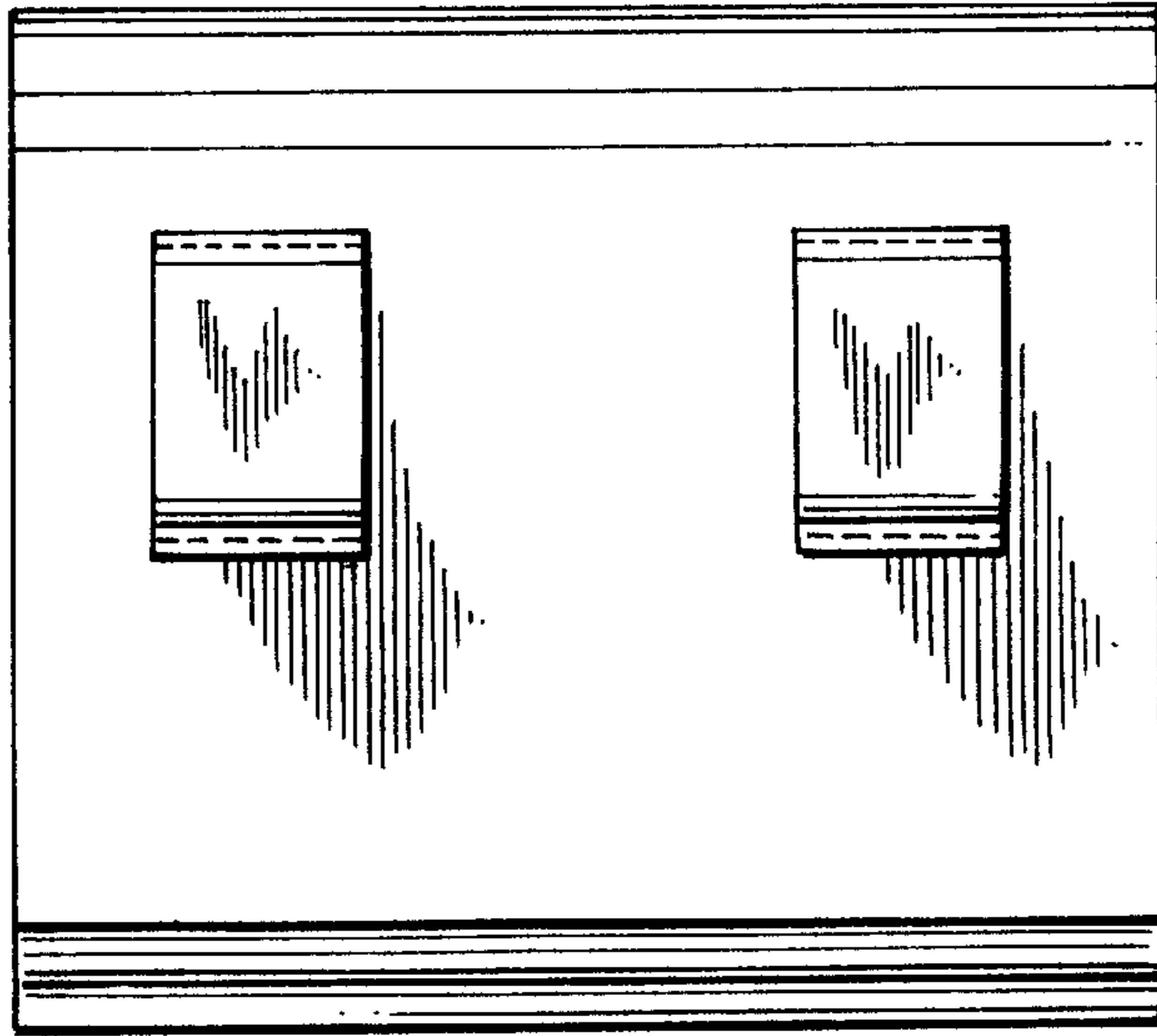

FIG. 4

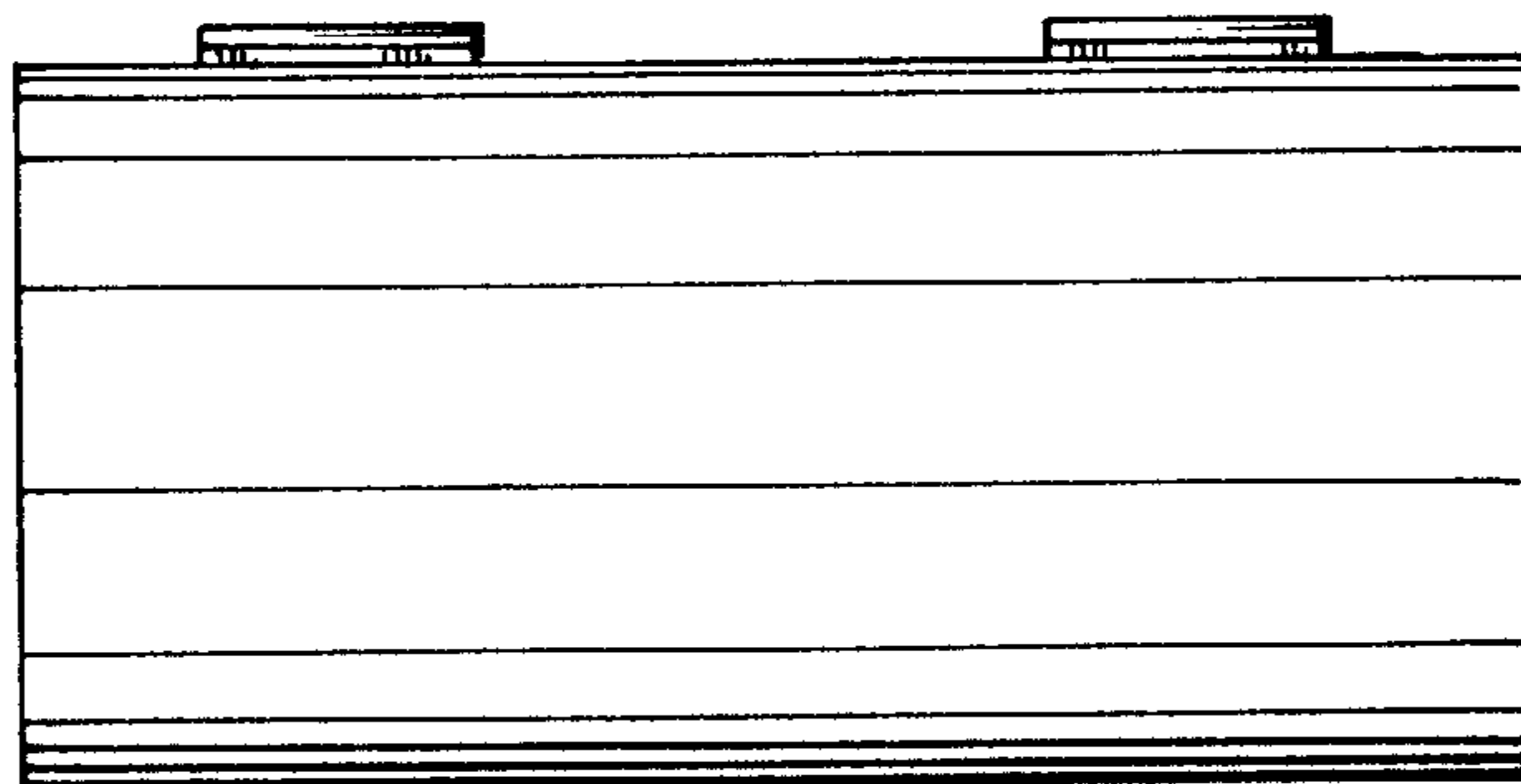

FIG. 5

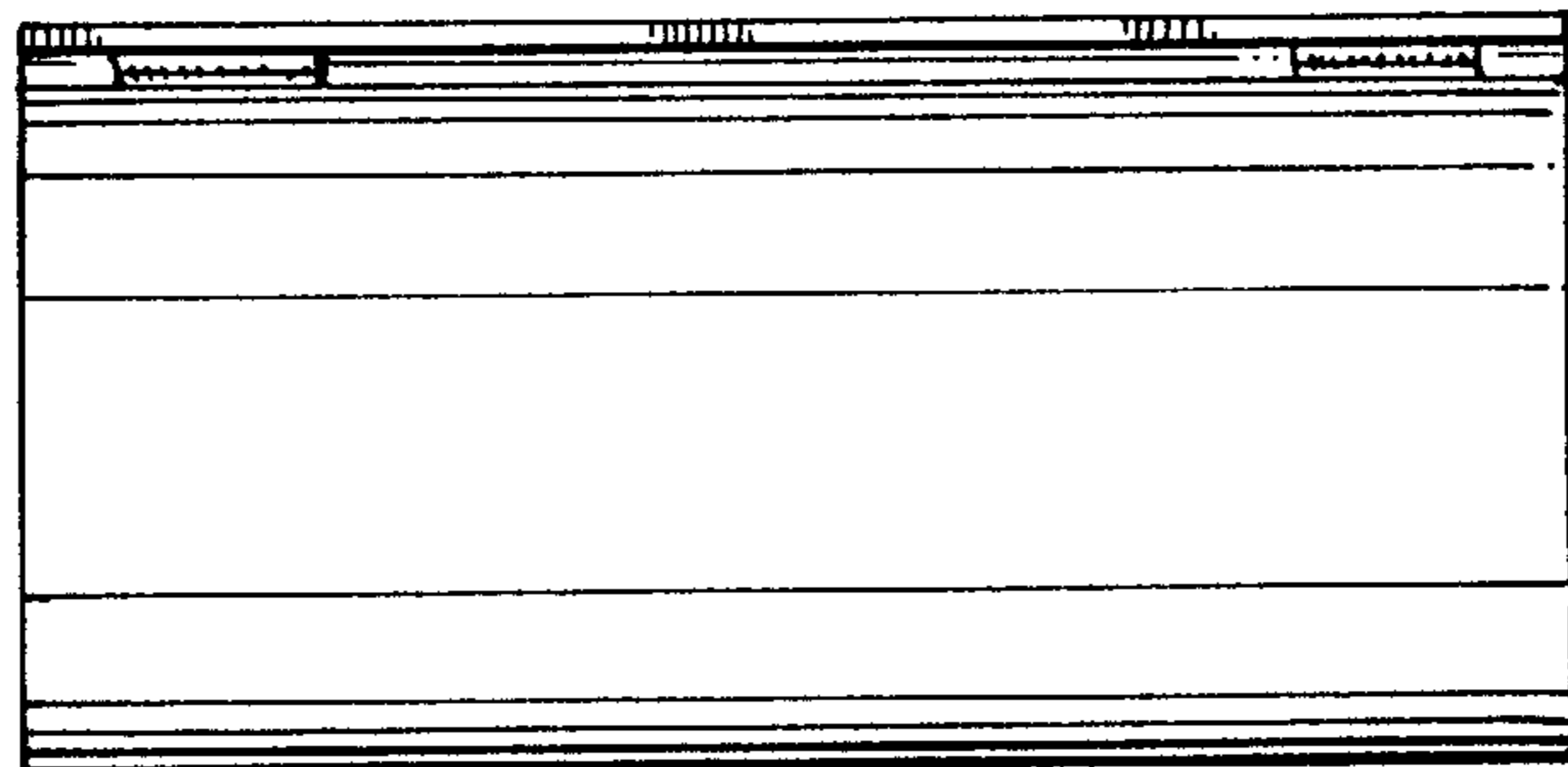

FIG. 6

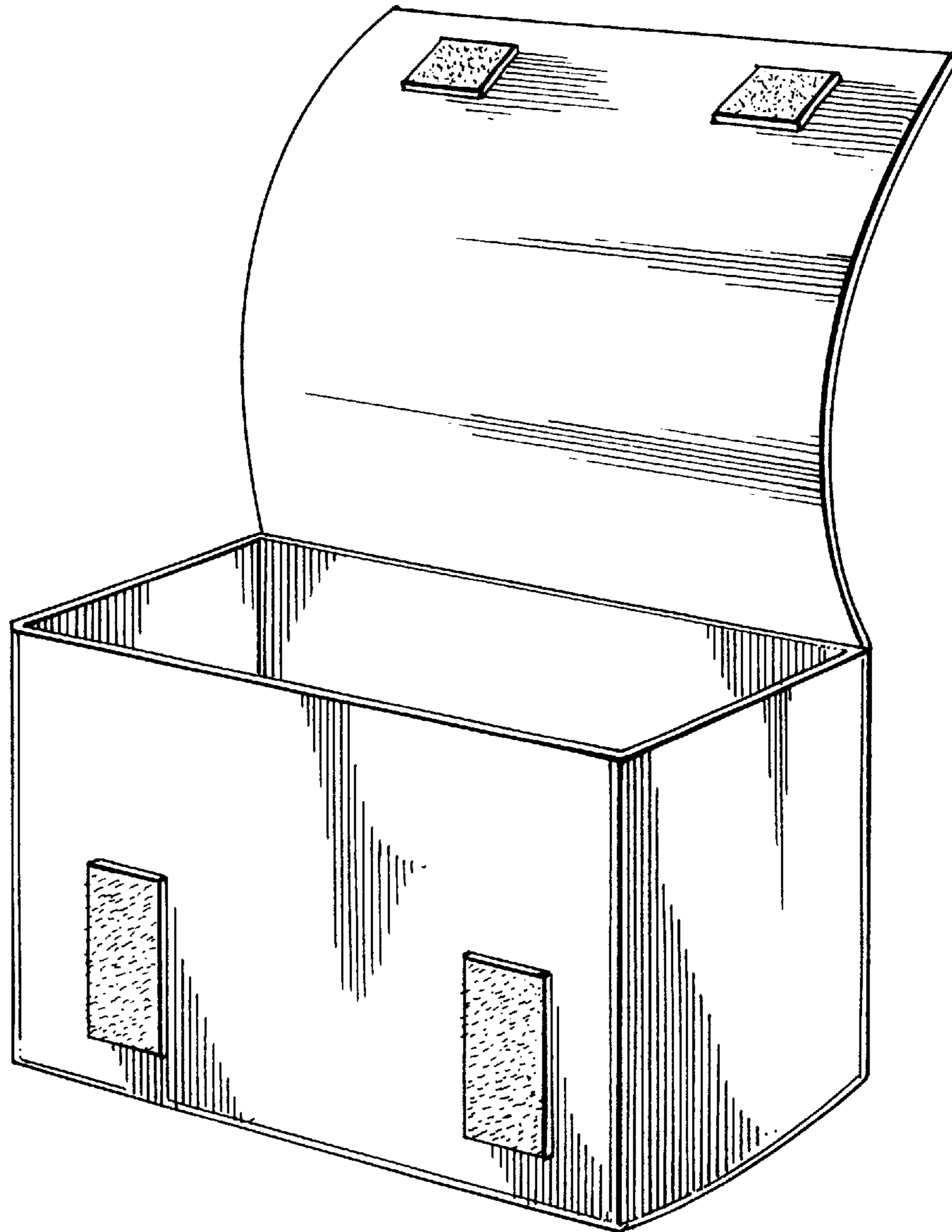

FIG.7