



US00D405263S

# United States Patent [19]

[11] **Patent Number:** **Des. 405,263**

**Au**

[45] **Date of Patent:** **\*\*Feb. 9, 1999**

[54] **CONTAINER FOR WATCH OR JEWELRY**

D. 344,234 2/1994 Kaplan ..... D9/423  
D. 373,931 9/1996 Whitehead ..... D9/307

[76] Inventor: **Ho Ching Au**, Blk. A, 9/F., Goodview Ind. Bldg., 11 Kin Fat St., Tuen Mun, N.T., Hong Kong

*Primary Examiner*—Philip S. Hyder  
*Attorney, Agent, or Firm*—David and Raymond; Raymond Y. Chan

[\*\*] Term: **14 Years**

### [57] CLAIM

[21] Appl. No.: **84,834**

The ornamental design for a container for watch or jewelry, as shown.

[22] Filed: **Mar. 11, 1998**

### DESCRIPTION

[51] **LOC (6) Cl.** ..... **03-01**

[52] **U.S. Cl.** ..... **D3/294; D9/420; D3/903**

[58] **Field of Search** ..... D3/273, 294, 295, D3/302, 903, 269, 270; D9/307, 420, 423, 424, 425; 206/6.1, 566, 526, 525

FIG. 1 is a perspective view showing my new design; FIG. 2 is a front view thereof; FIG. 3 is a left end view thereof; FIG. 4 is a right end view thereof; FIG. 5 is a top view thereof; FIG. 6 is a bottom view thereof; FIG. 7 is a rear view thereof; and, FIG. 8 is a perspective view showing my new design in an open condition.

### [56] References Cited

#### U.S. PATENT DOCUMENTS

D. 167,668 9/1952 Bedinger ..... D9/420  
D. 281,446 11/1985 Minsky ..... D9/420  
D. 306,973 4/1990 Kaplan ..... D9/423

**1 Claim, 8 Drawing Sheets**

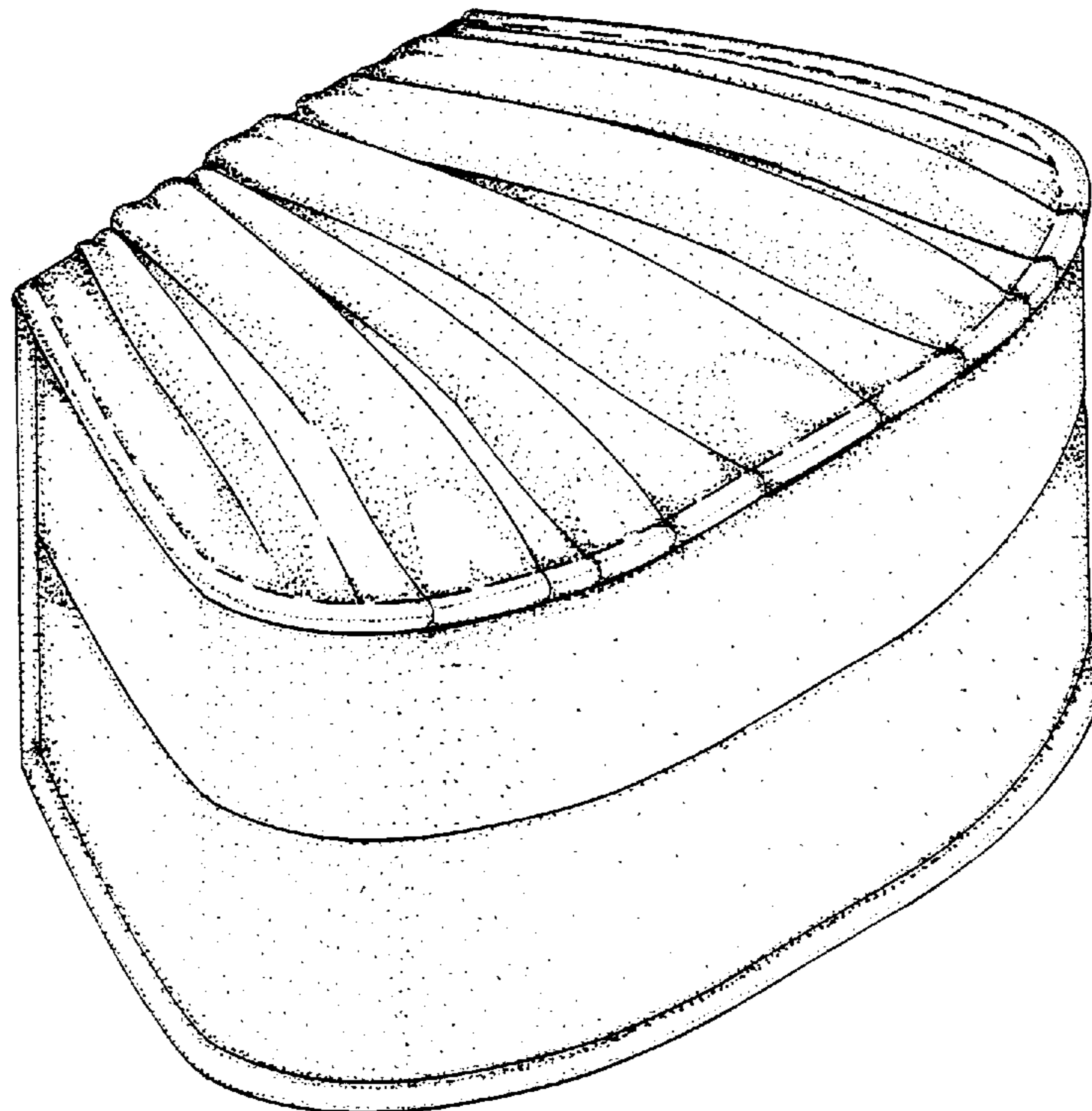

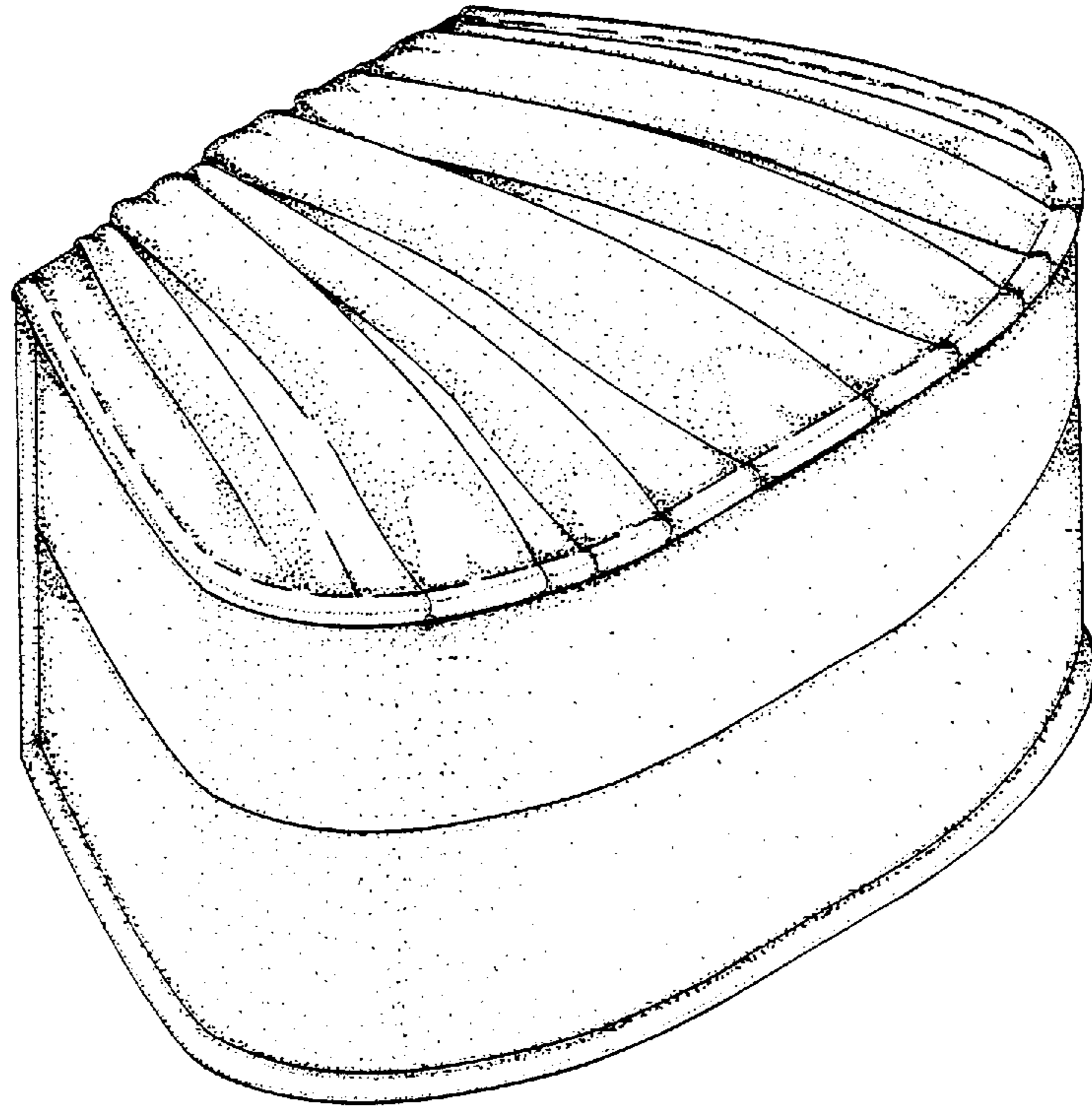

FIG. 1

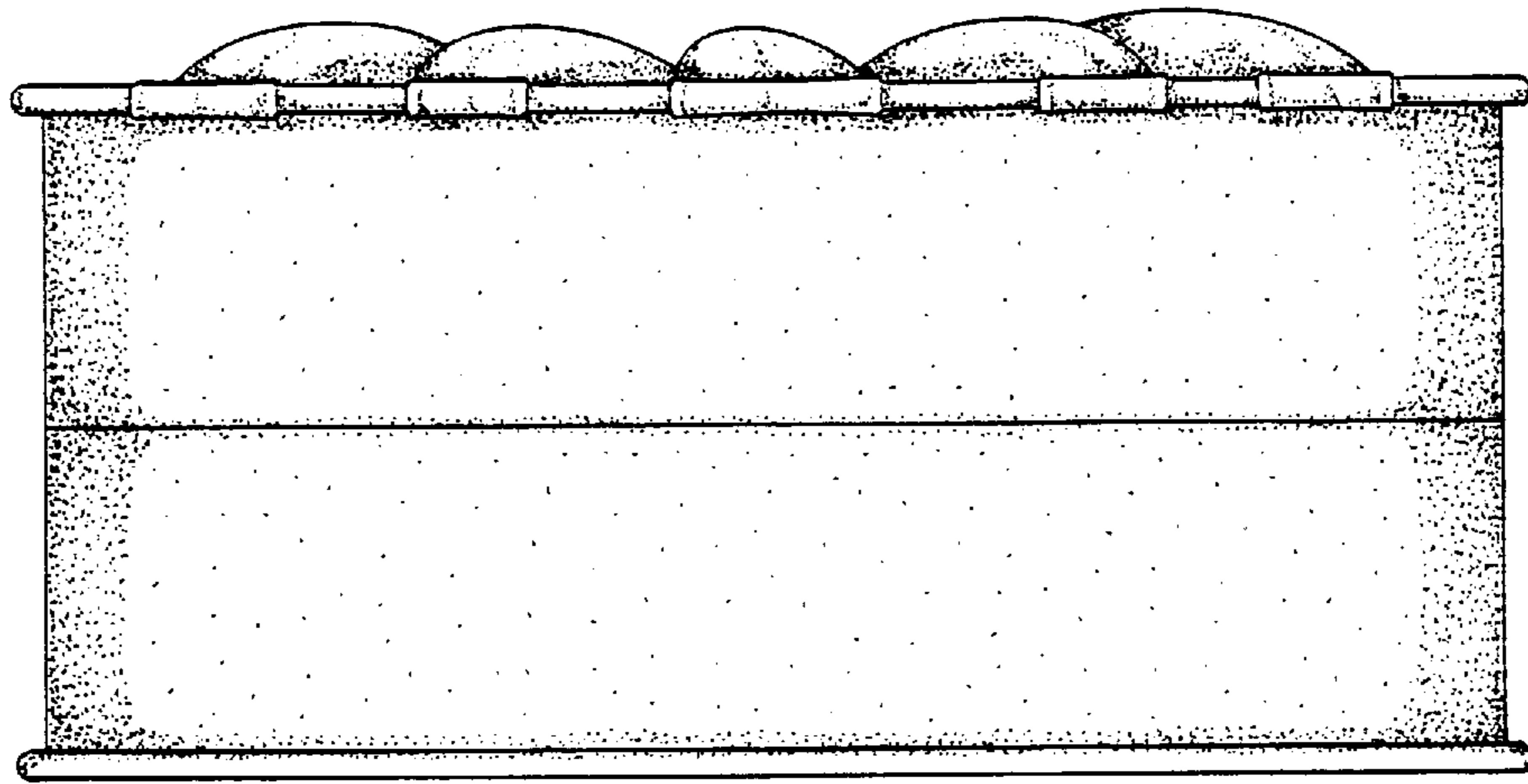

FIG. 2

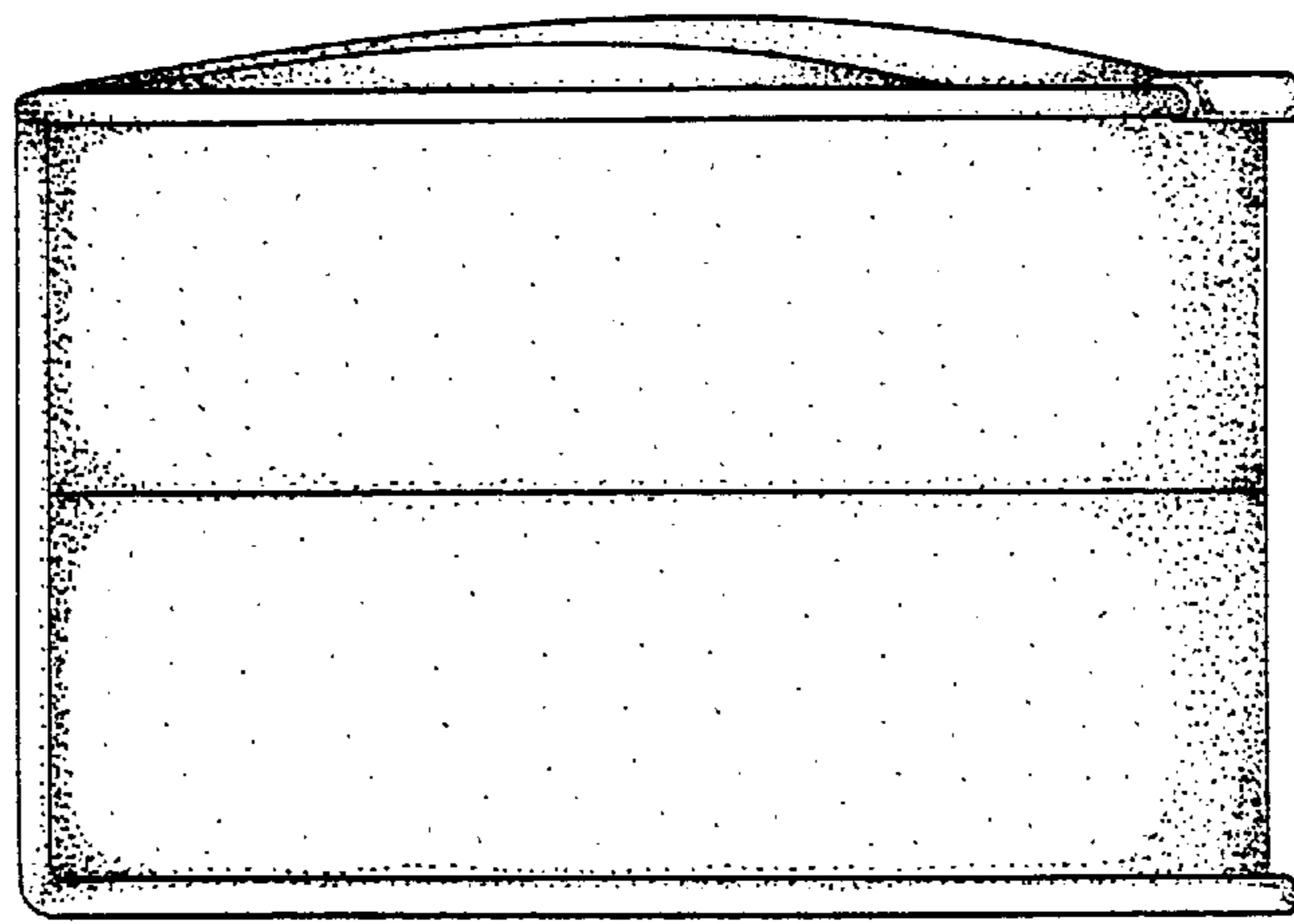

FIG. 3

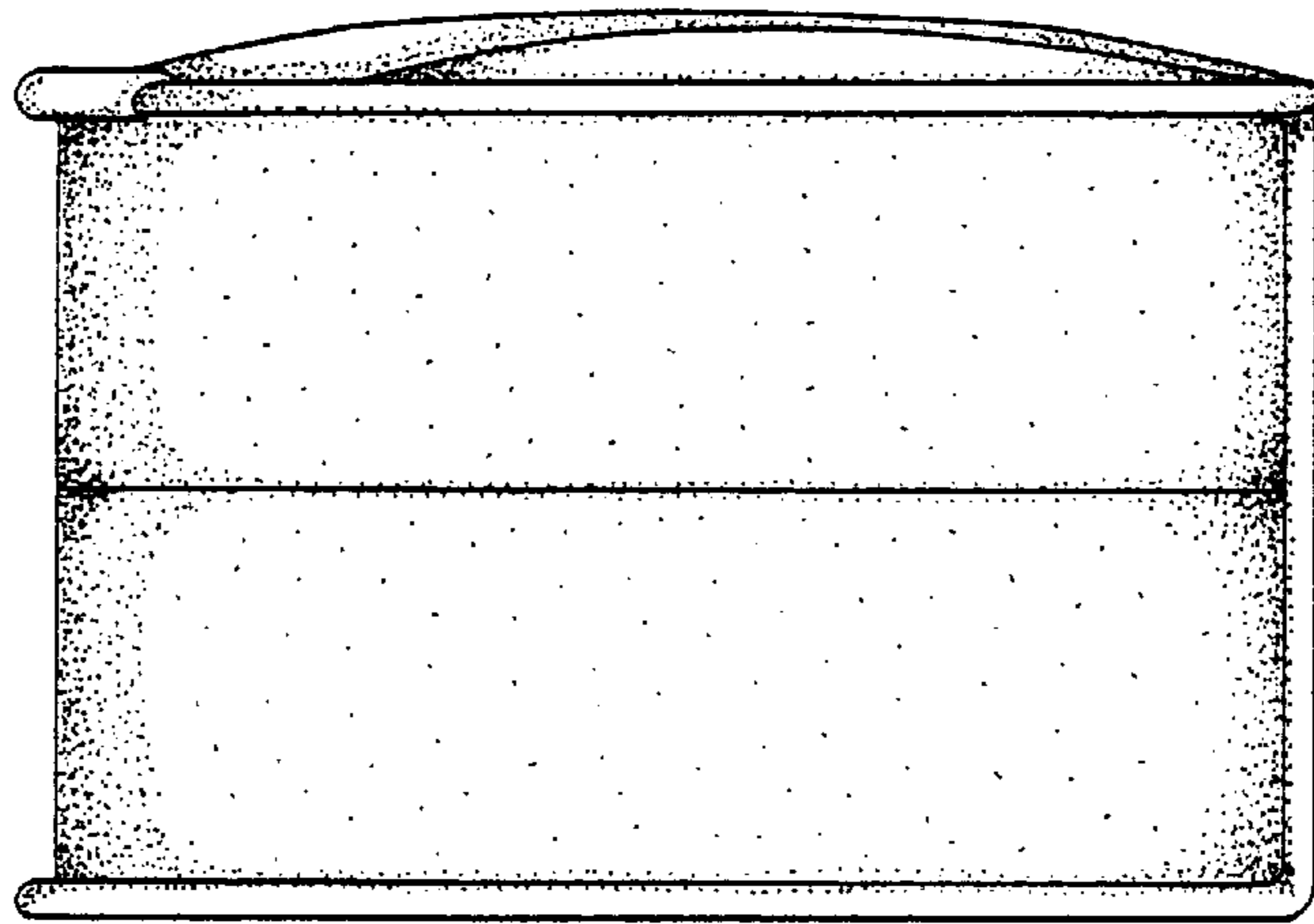

FIG. 4

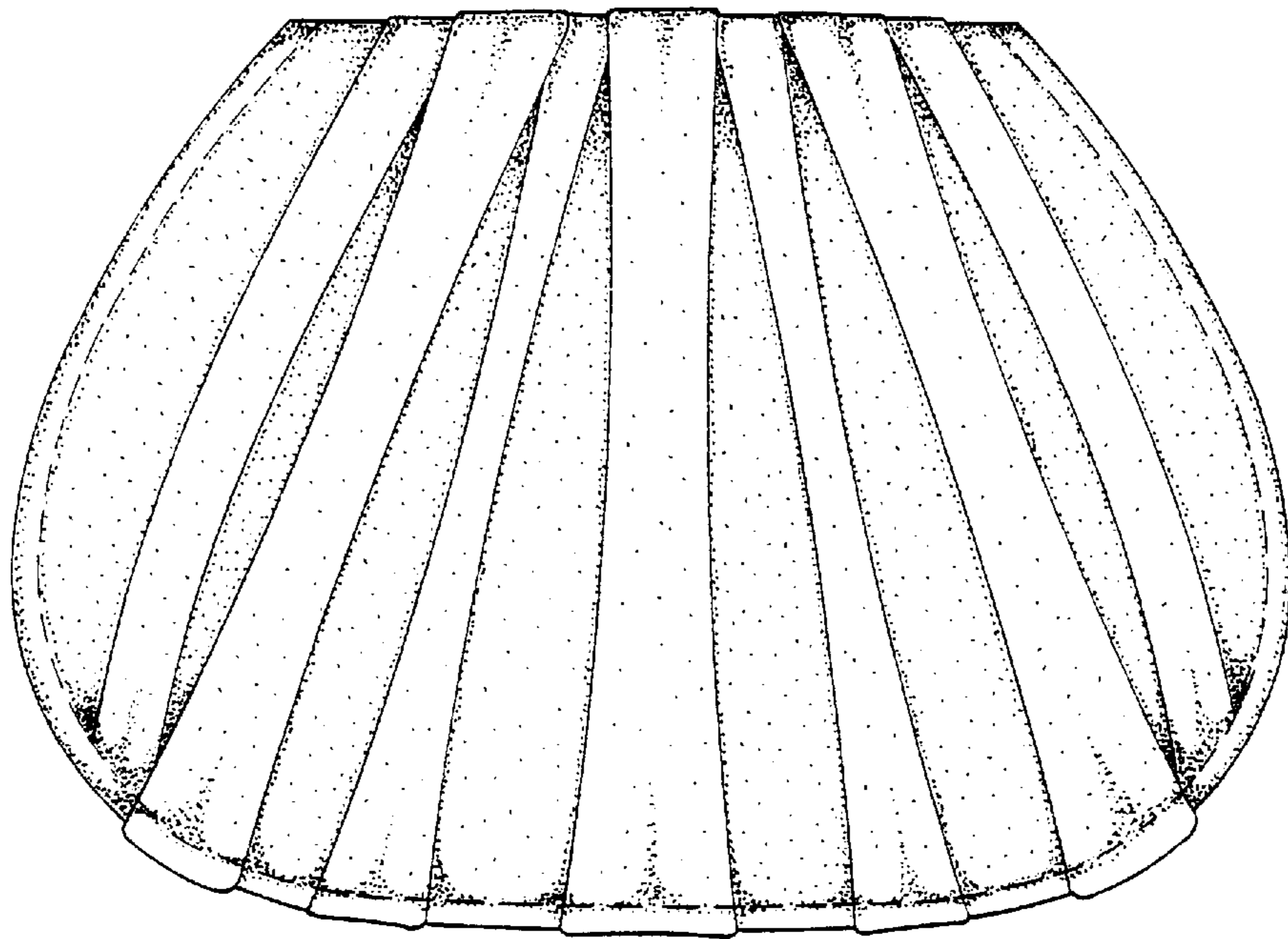

FIG. 5

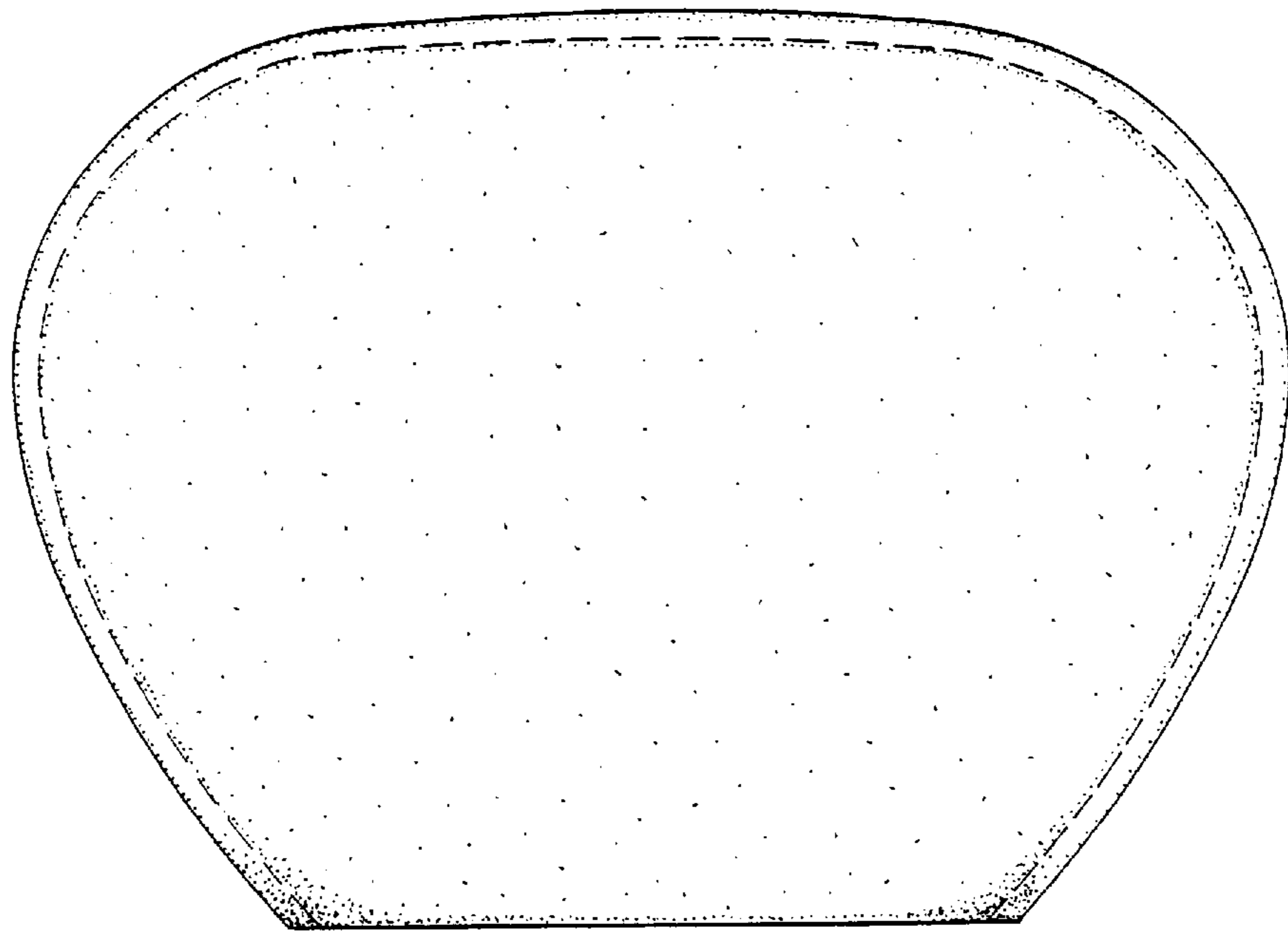

FIG. 6

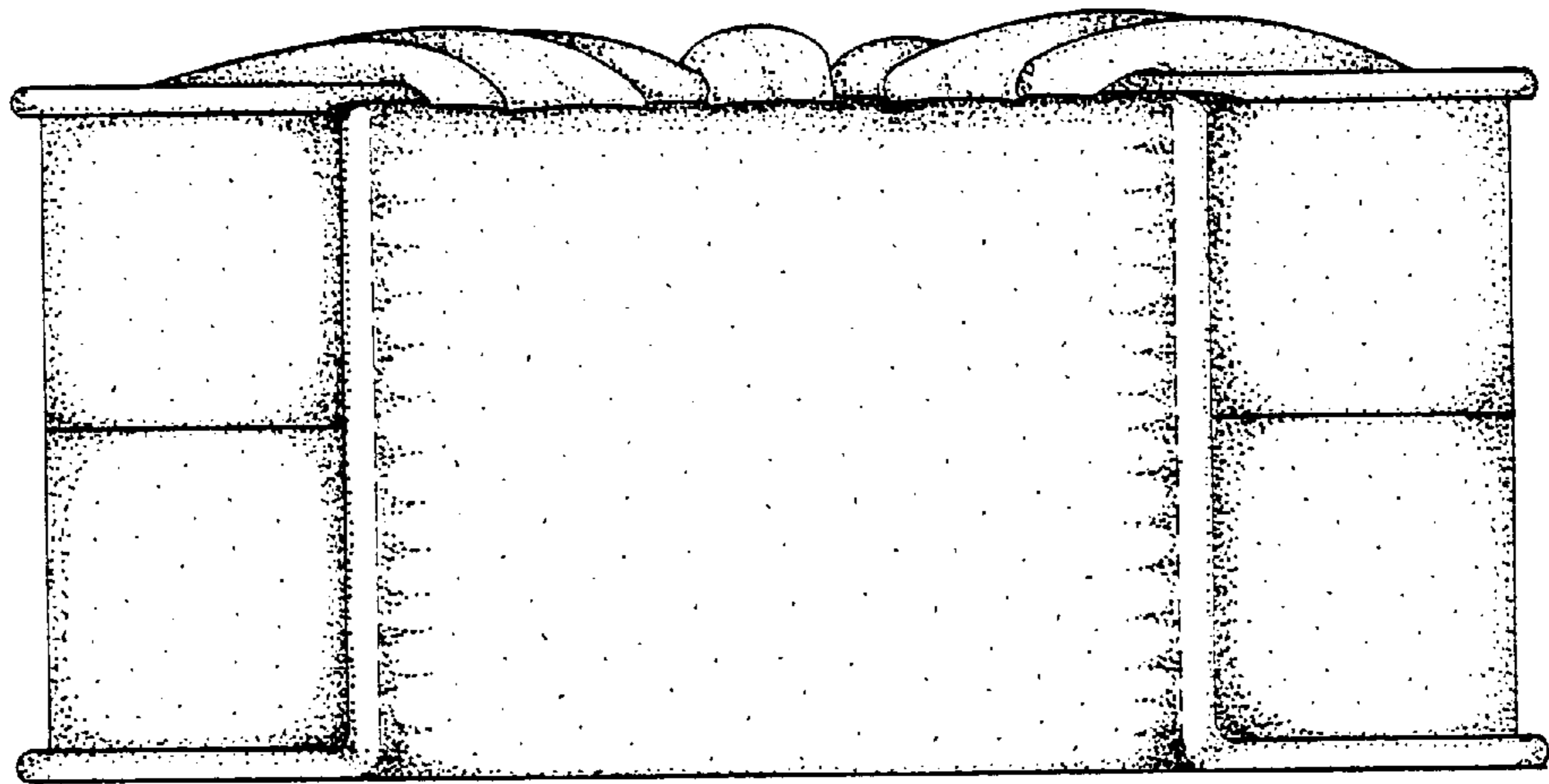

FIG. 7



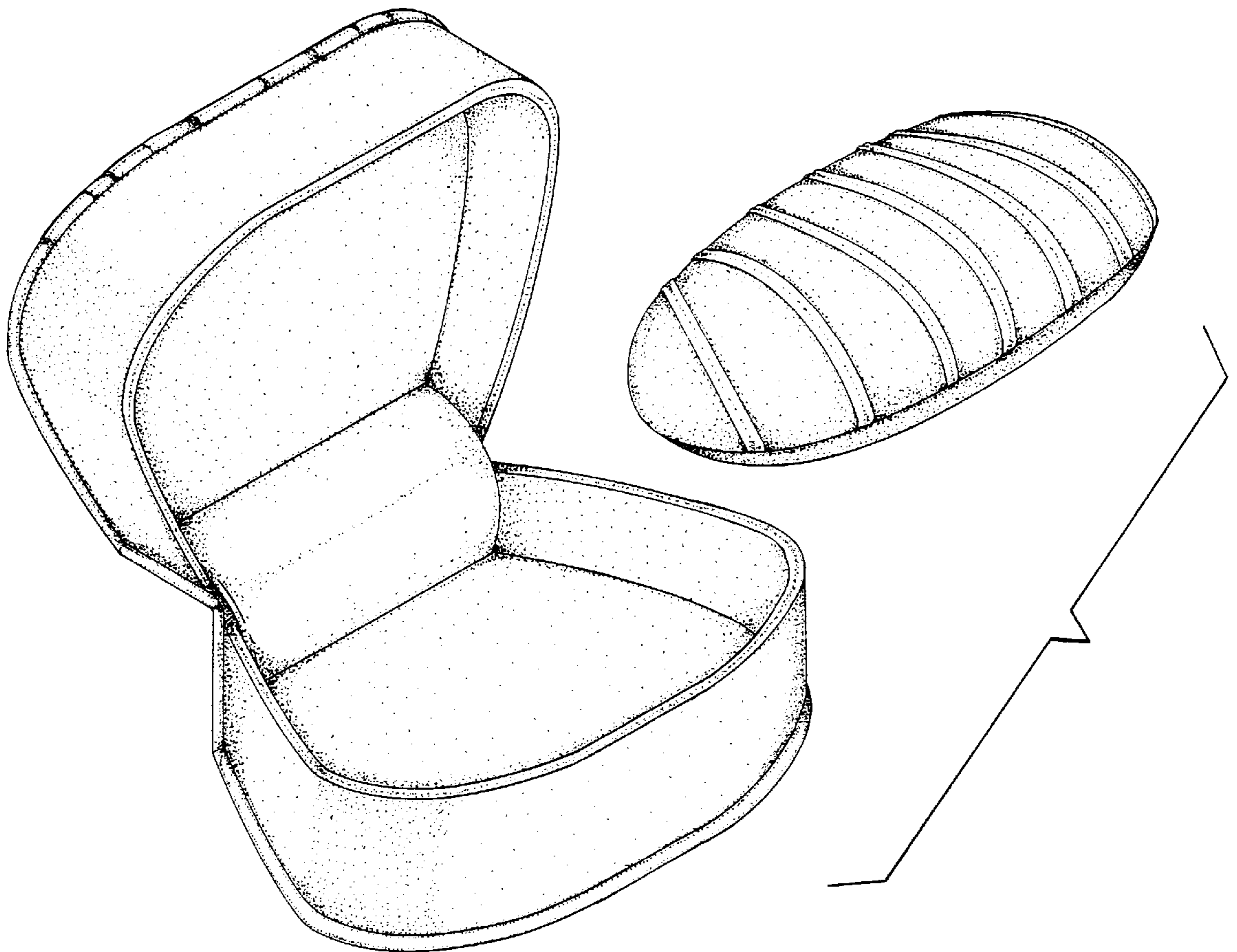

FIG. 8