



US00D405262S

United States Patent [19] Cashdollar

[11] **Patent Number:** **Des. 405,262**

[45] **Date of Patent:** ****Feb. 9, 1999**

[54] **BRIEFCASE**

[76] **Inventor:** **Karen Cashdollar**, Rd. #1 Box 164,
Shelocta, Pa. 15774

[**] **Term:** **14 Years**

[21] **Appl. No.:** **85,253**

[22] **Filed:** **Mar. 19, 1998**

[51] **LOC (6) Cl.** **03-01**

[52] **U.S. Cl.** **D3/276; D3/284; D3/900**

[58] **Field of Search** D3/273, 276, 274,
D3/279, 284, 294, 900; 190/110, 111, 112,
113, 114, 115, 901

[56] **References Cited**

U.S. PATENT DOCUMENTS

D. 267,834	2/1983	Yew	D3/284
D. 275,833	10/1984	Malpass	D3/284
D. 305,705	1/1990	Stewart	D3/284
D. 318,371	7/1991	Leverette	D3/284
D. 379,562	6/1997	Carter	D3/284

D. 380,899	7/1997	Hockaday	D3/276
2,541,890	2/1951	Schaperkotter	190/109
5,178,246	1/1993	Kramer	190/109
5,595,302	1/1997	Maydwell et al.	190/109

Primary Examiner—Philip S. Hyder

[57] **CLAIM**

The ornamental design for a briefcase, as shown.

DESCRIPTION

FIG. 1 is a front elevational view of the briefcase of the present invention;
 FIG. 2 is a rear elevational view of the briefcase of FIG. 1;
 FIG. 3 is a left side elevational view of the briefcase of FIG. 1;
 FIG. 4 is a right side elevational view of the briefcase of FIG. 1;
 FIG. 5 is a top plan view of the briefcase of FIG. 1;
 FIG. 6 is a bottom plan view of the briefcase of FIG. 1; and,
 FIG. 7 is a top, front, right side perspective view of the briefcase of FIG. 1.

1 Claim, 4 Drawing Sheets

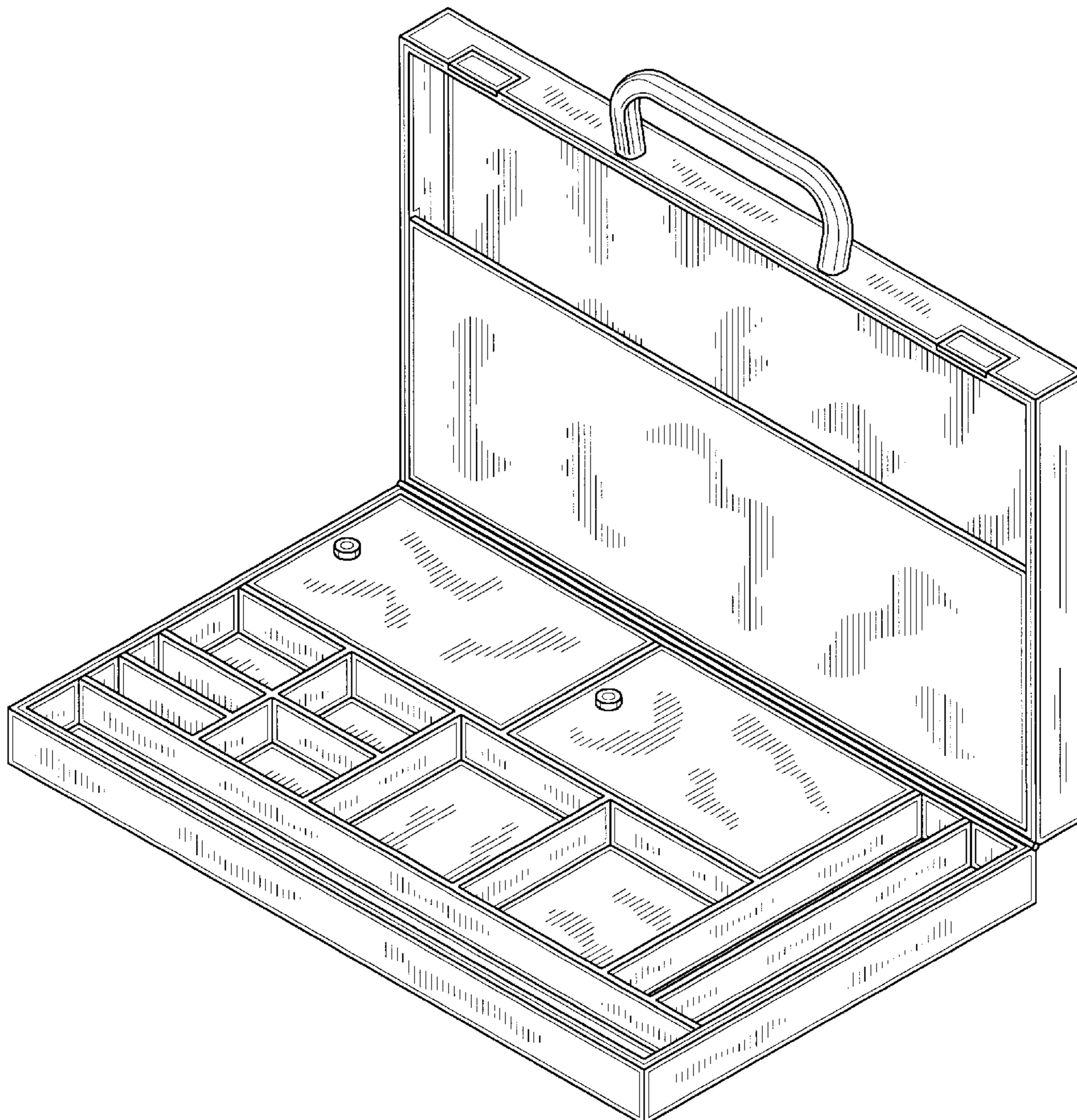

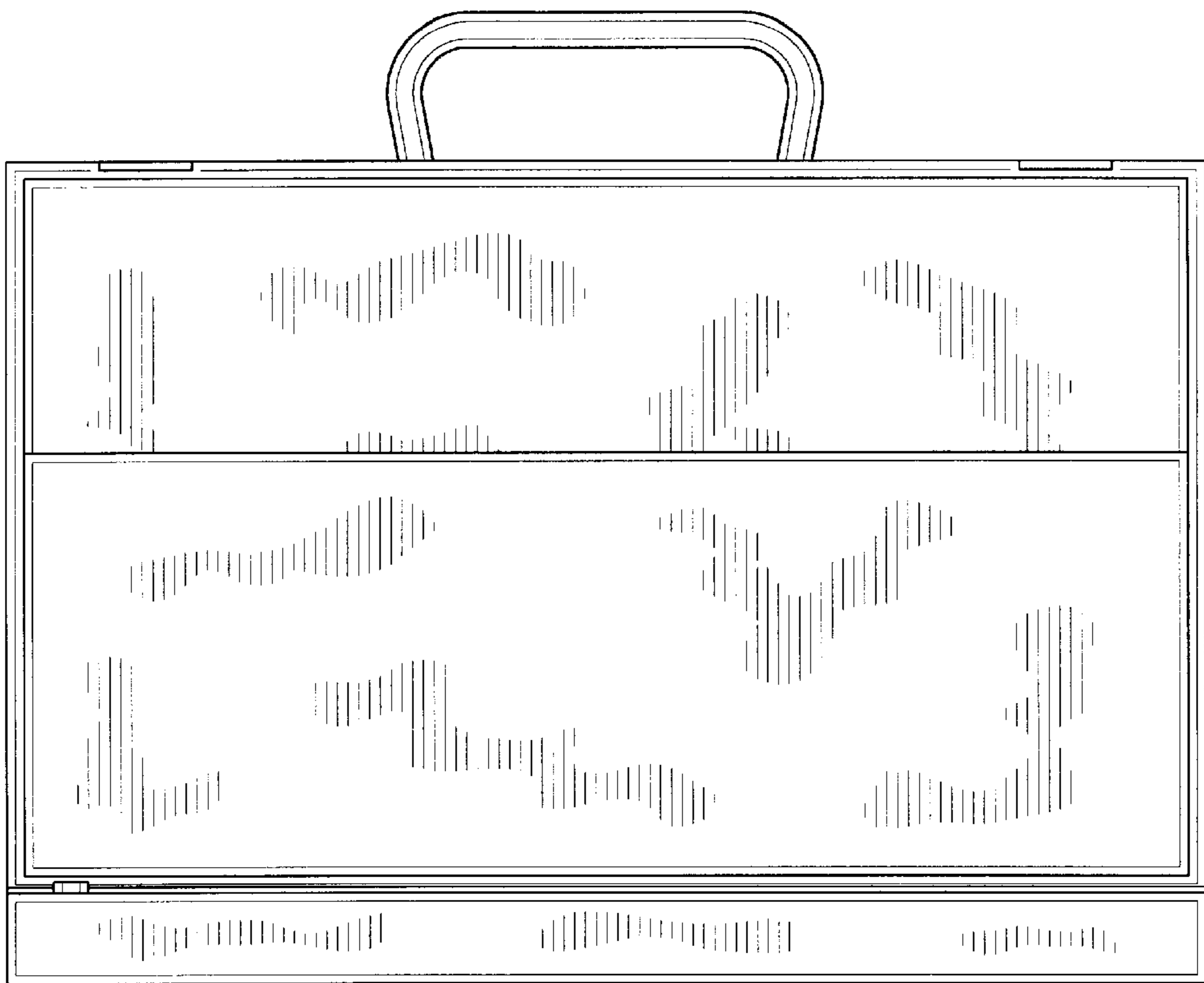

Fig. 1

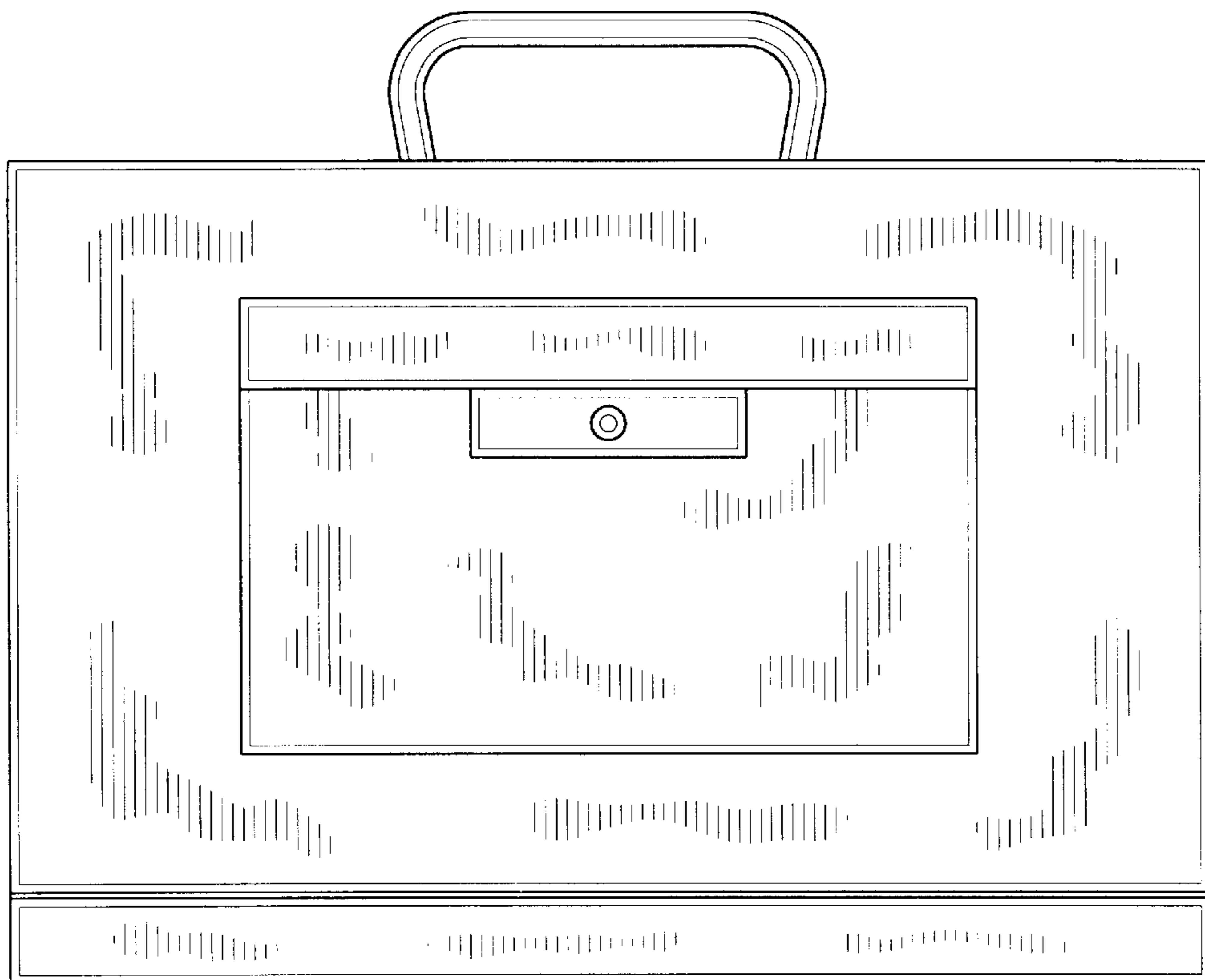

Fig. 2

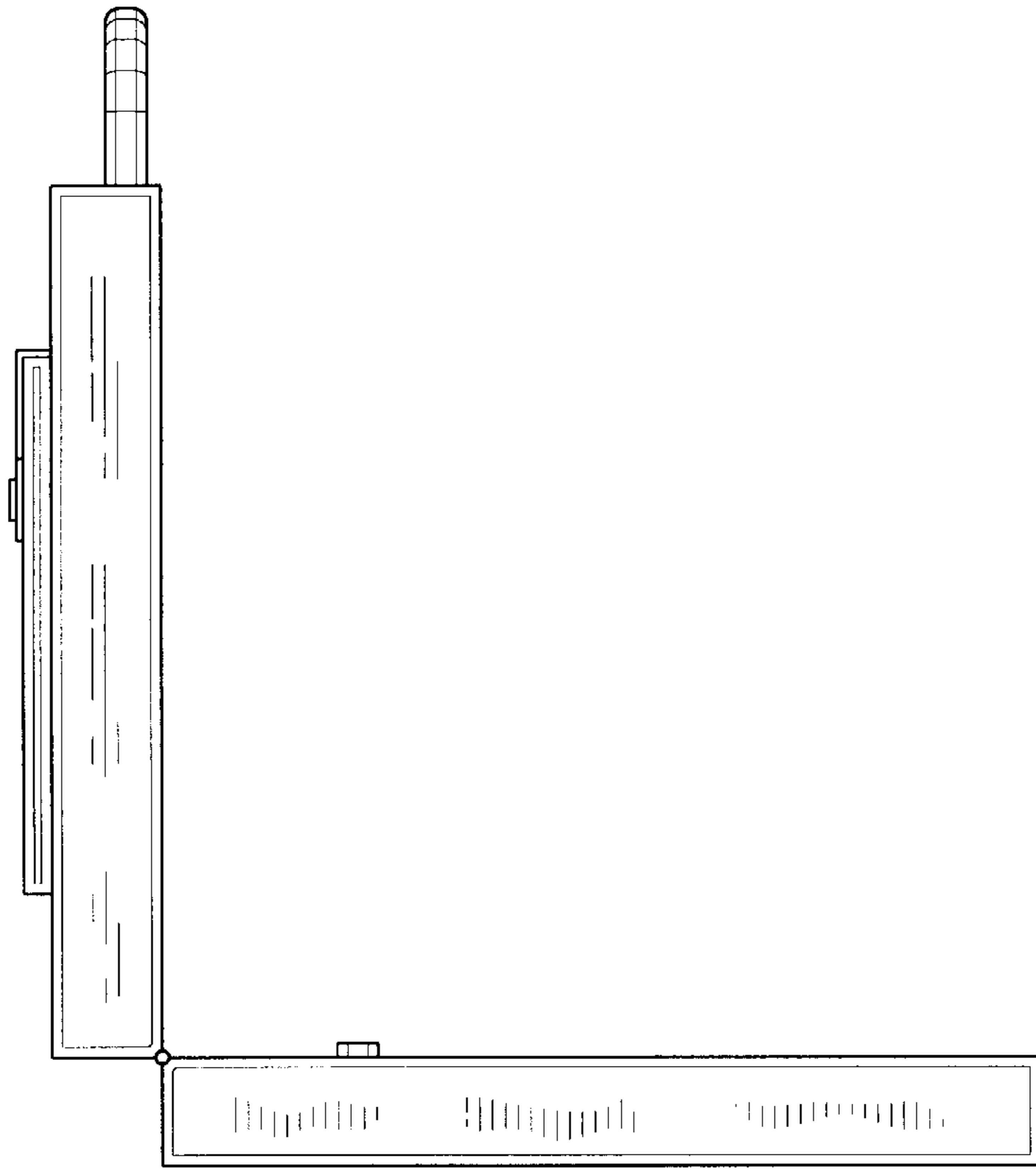

Fig. 3

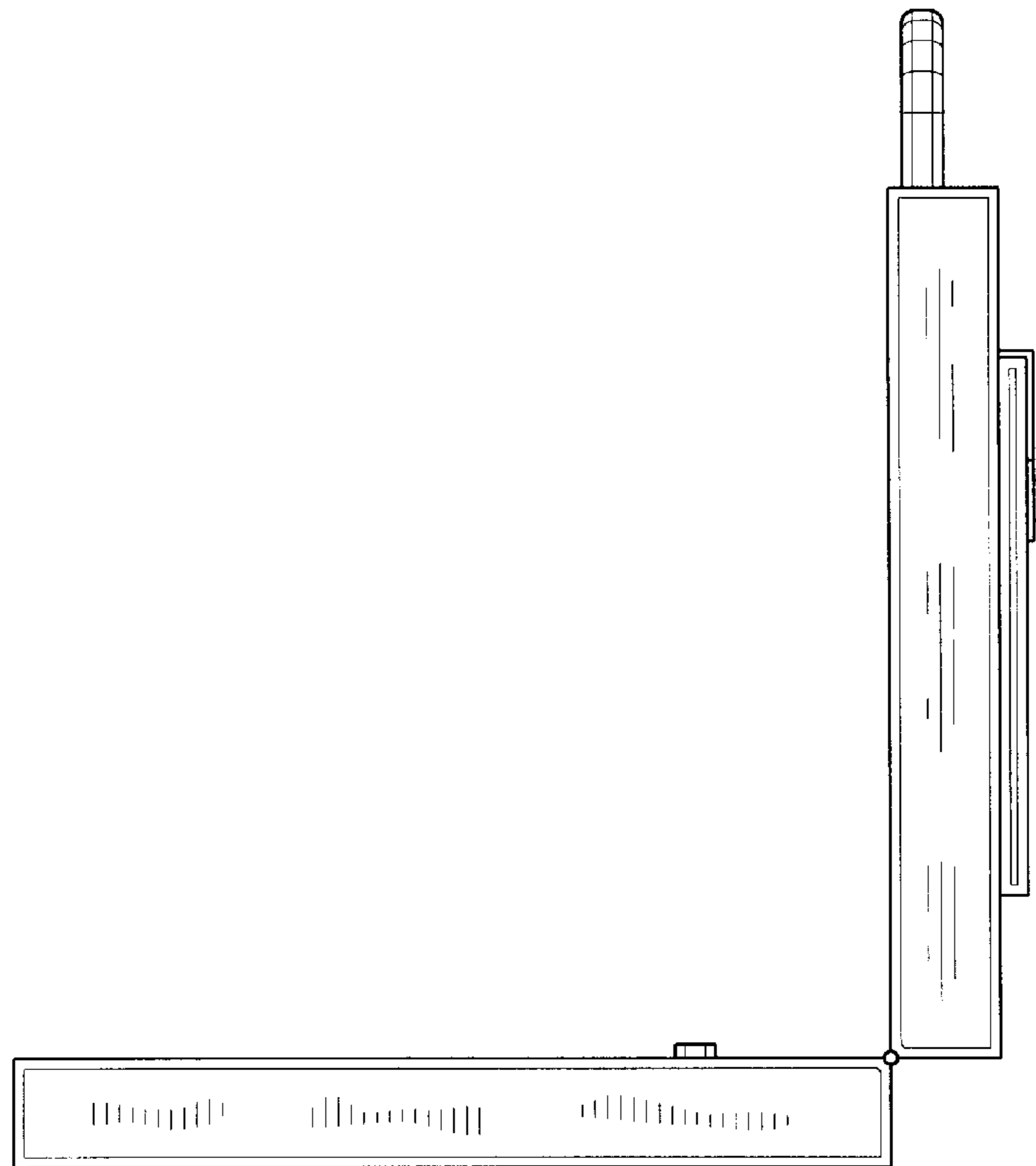

Fig. 4

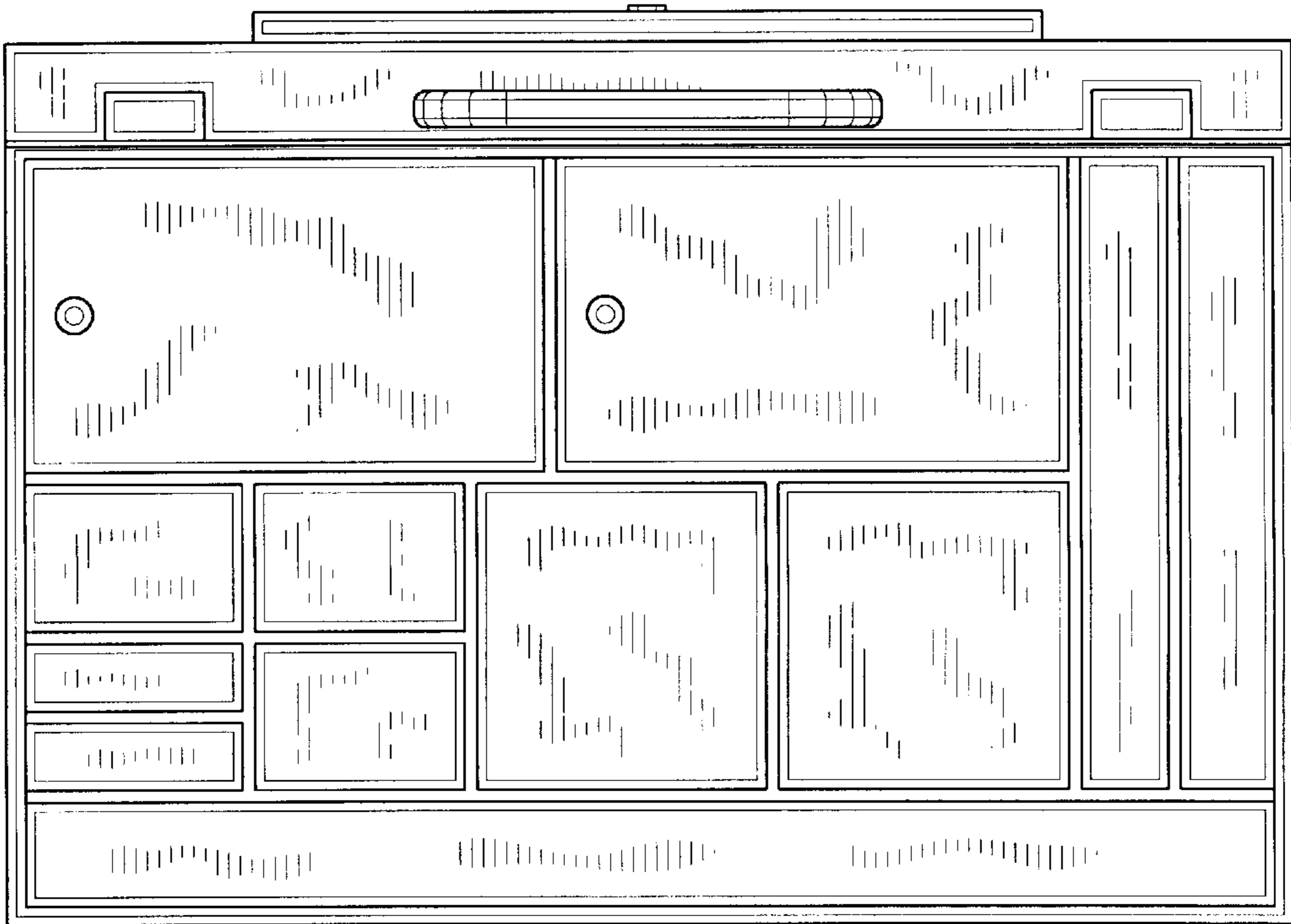

Fig. 5

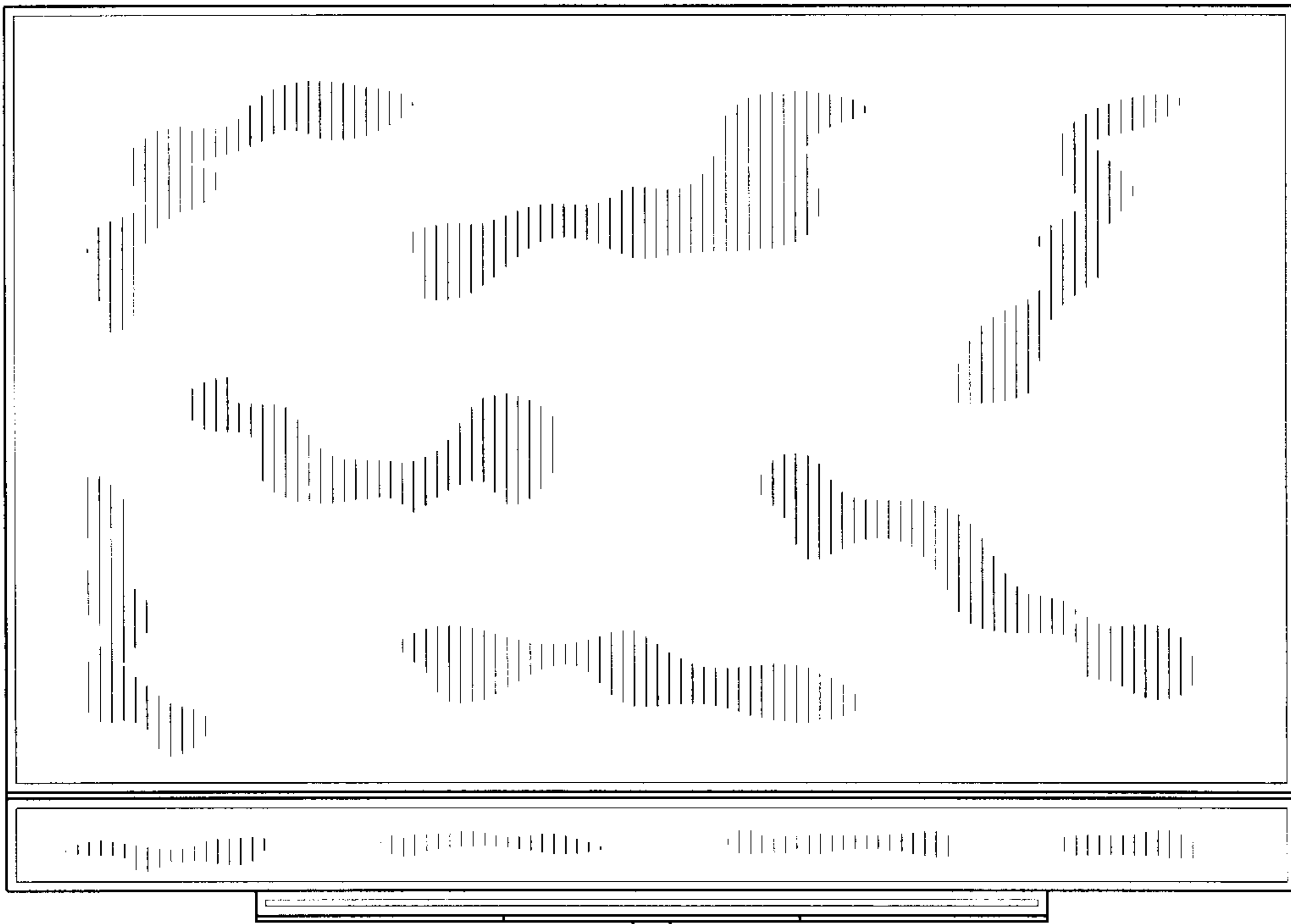

Fig. 6

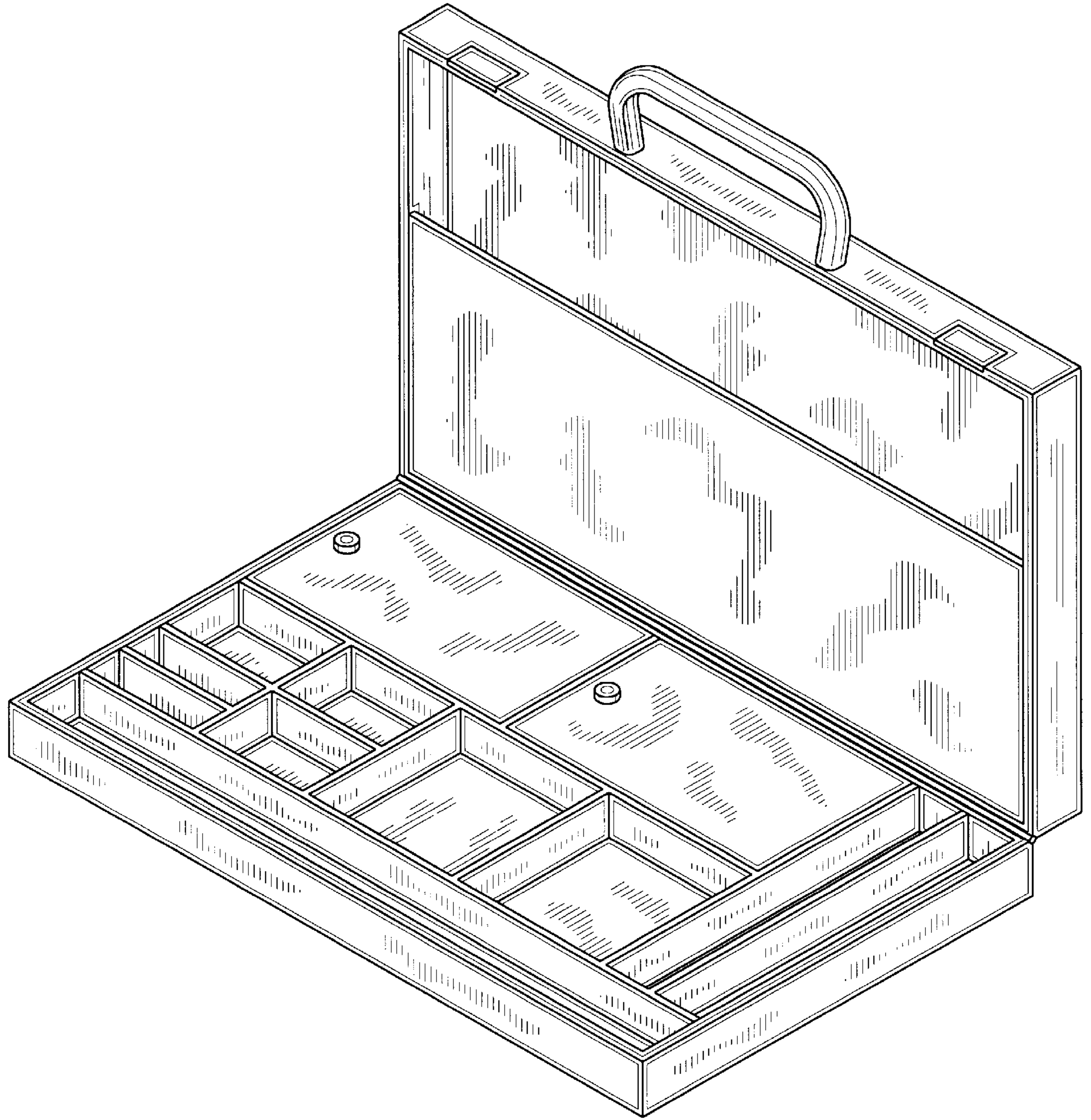

Fig. 7