



US00D405137S

United States Patent [19]

Nelson

[11] Patent Number: Des. 405,137

[45] Date of Patent: **Feb. 2, 1999

[54] **GOLF PUTTER HEAD**

Attorney, Agent, or Firm—Darrell F. Marquette

[75] Inventor: **Michael J. Nelson**, Phoenix, Ariz.

[57] **CLAIM**

[73] Assignee: **Karsten Manufacturing Corp.**,
Phoenix, Ariz.

The ornamental design for a golf putter head, as shown and described.

[**] Term: **14 Years**

DESCRIPTION

[21] Appl. No.: **83,289**

FIG. 1 is a perspective view of a golf putter head showing my new design;

[22] Filed: **Jan. 26, 1998**

FIG. 2 is a toe end view of the golf putter head shown in FIG. 1;

[51] **LOC (6) Cl.** **21-02**

[52] **U.S. Cl.** **D21/738; D21/742**

[58] **Field of Search** **D21/736-746;**
473/251-256, 327, 340, 341, 328

FIG. 3 is a heel end view of the golf putter head shown in FIG. 1;

[56] **References Cited**

U.S. PATENT DOCUMENTS

D. 240,751	7/1976	Taylor	D21/734
D. 377,818	2/1997	Gray et al.	D21/745
D. 378,688	4/1997	Cameron	D21/745
D. 379,645	6/1997	Cameron	D21/745
D. 393,031	3/1998	Cameron	D21/745
3,997,170	12/1976	Goldberg	473/327
4,073,492	2/1978	Taylor	473/252
5,533,728	7/1996	Pehoski et al.	473/252
5,676,603	10/1997	Miller	473/253 X

FIG. 4 is a sectional view taken along lines 4—4 in FIG. 7;

FIG. 5 is a front elevational view of the golf putter head shown in FIG. 1;

FIG. 6 is a rear elevational view of the golf putter head shown in FIG. 1;

FIG. 7 is a top plan view of the golf putter head shown in FIG. 1; and,

FIG. 8 is a bottom view of the golf putter head shown in FIG. 1.

OTHER PUBLICATIONS

Golf world, p. 8, Tiger Shark putter, Aug. 1977.

The broken lines in FIG. 1 showing a shaft portion are for illustrative purposes only and form no part of the claimed design.

Primary Examiner—Ted Shooman
Assistant Examiner—Mitchell I. Siegel

1 Claim, 2 Drawing Sheets

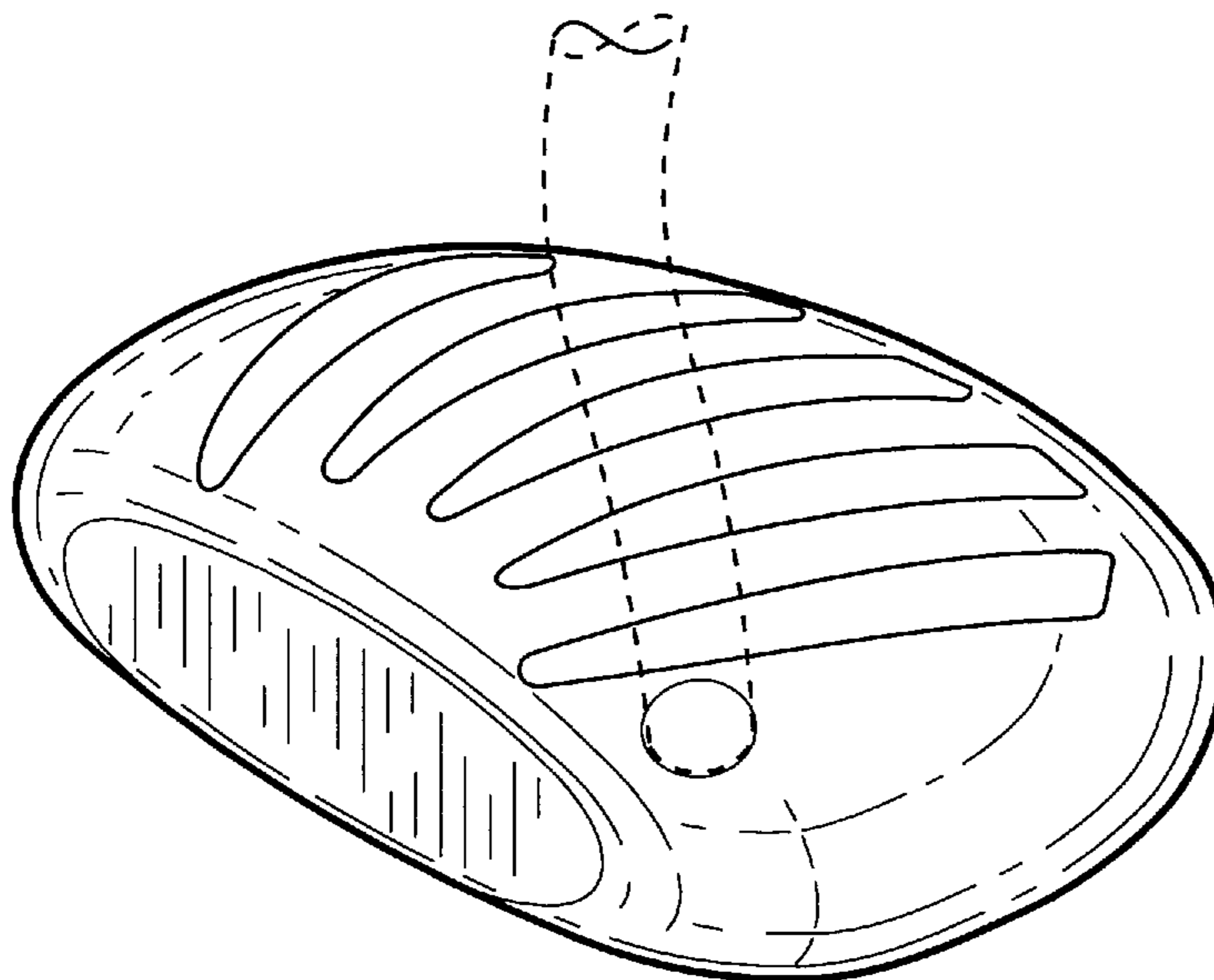

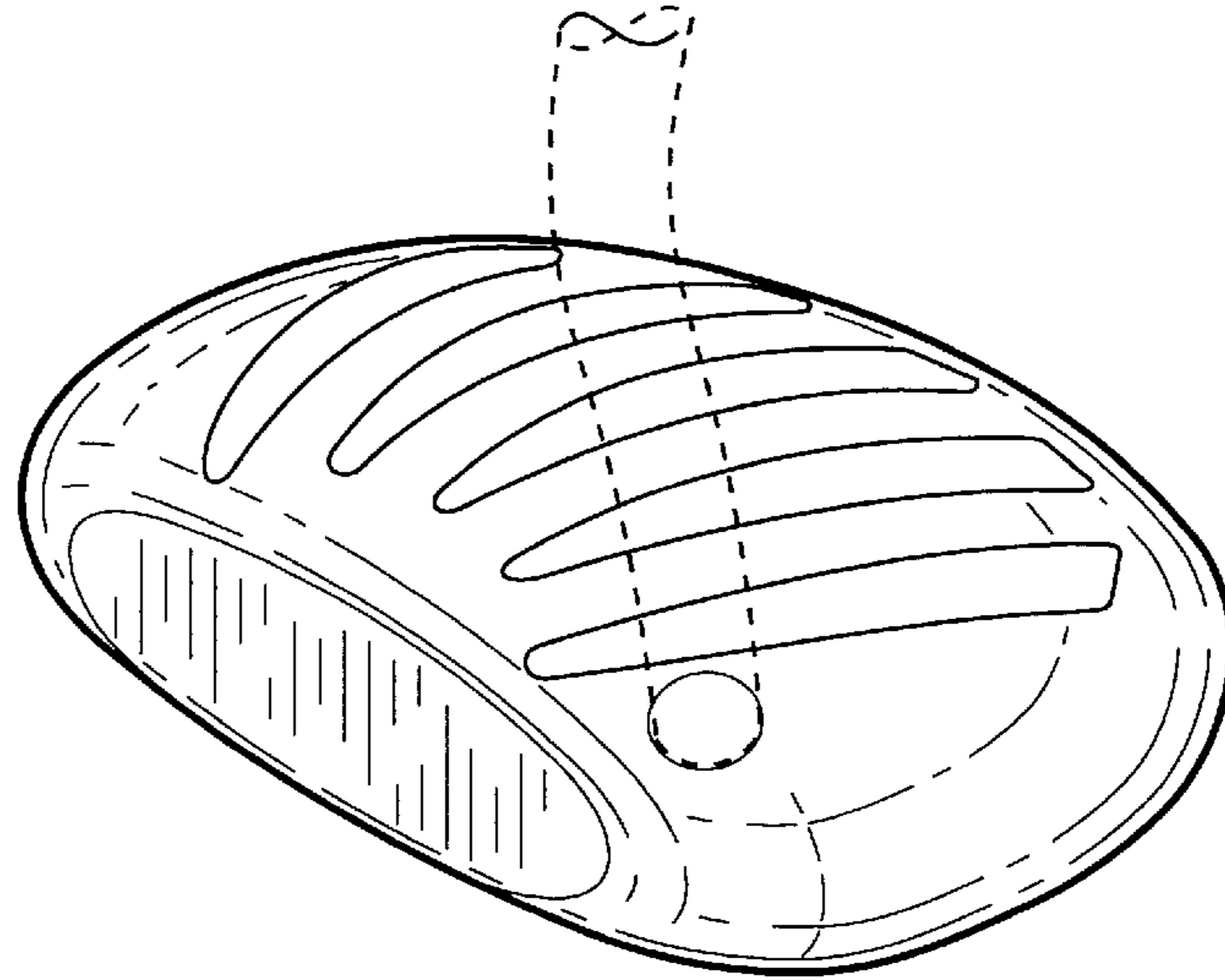

Fig.1

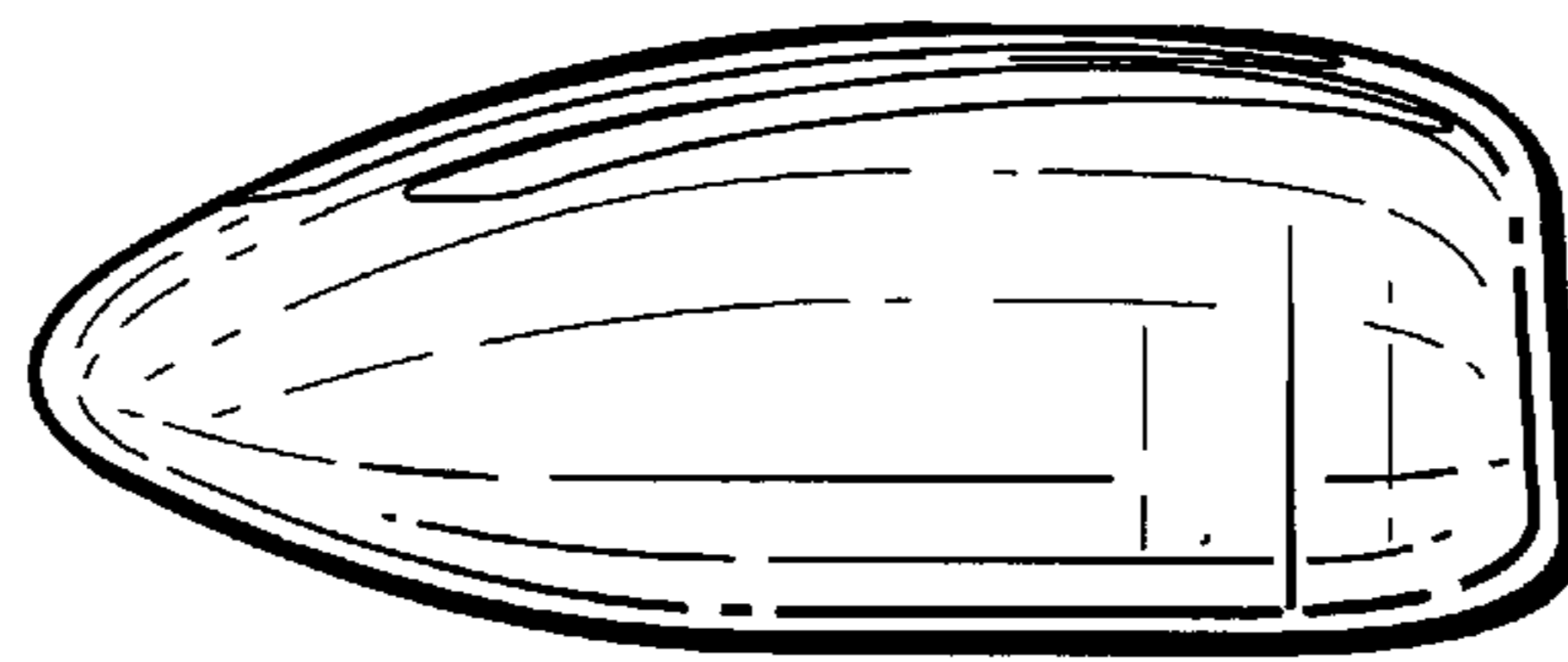

Fig.2

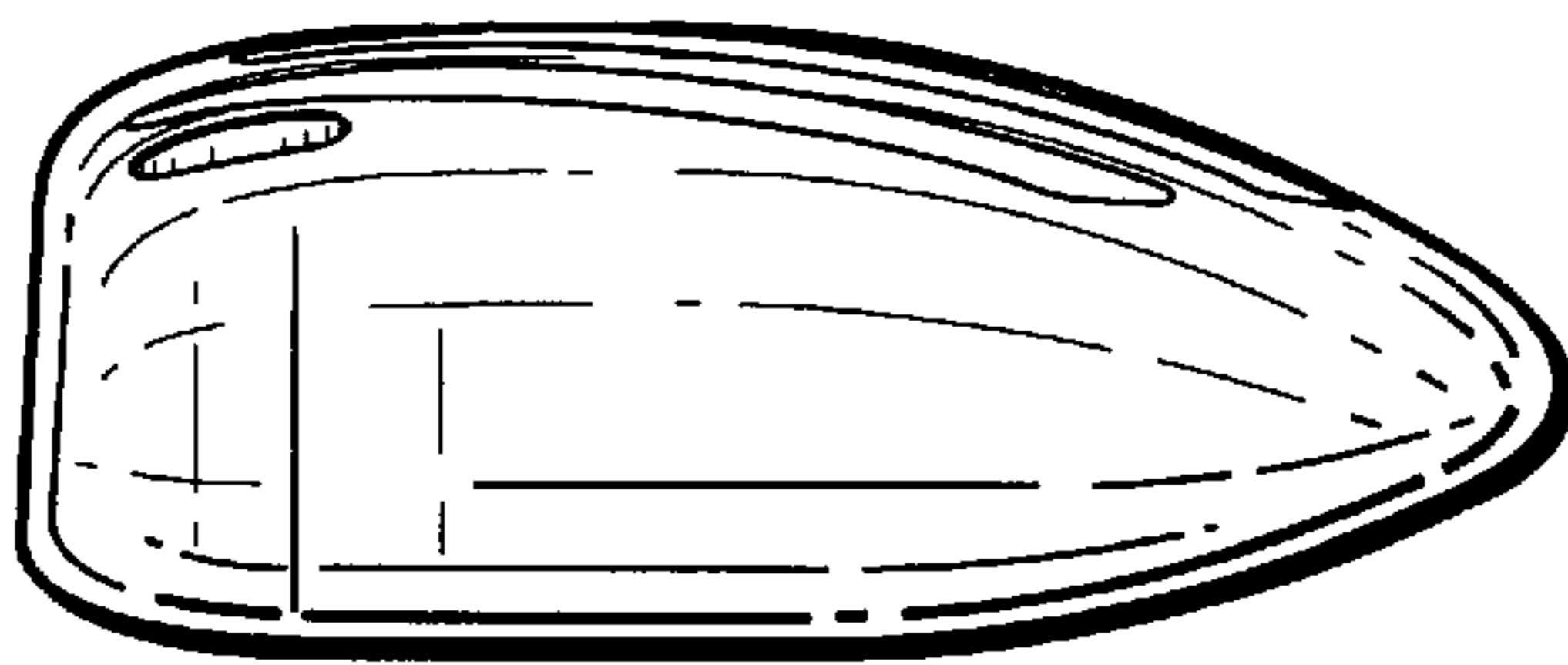

Fig.3

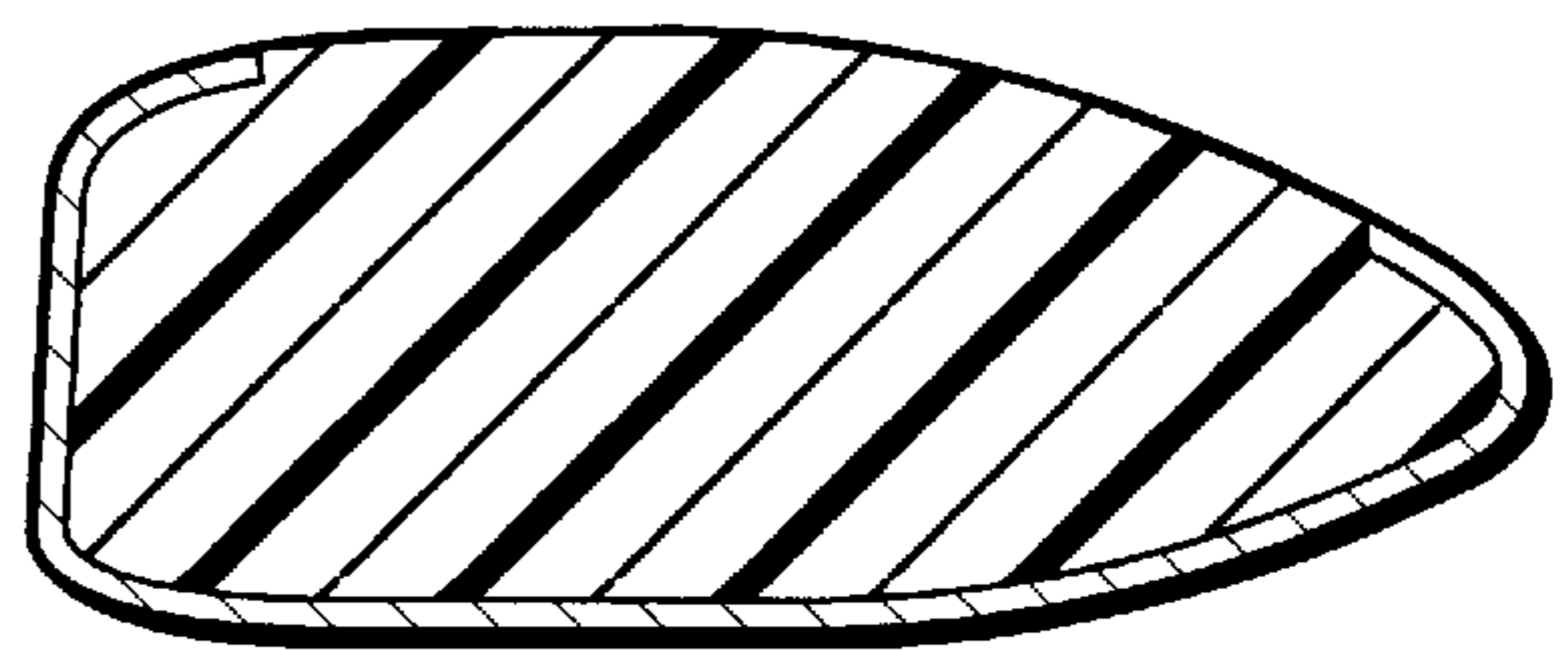

Fig.4

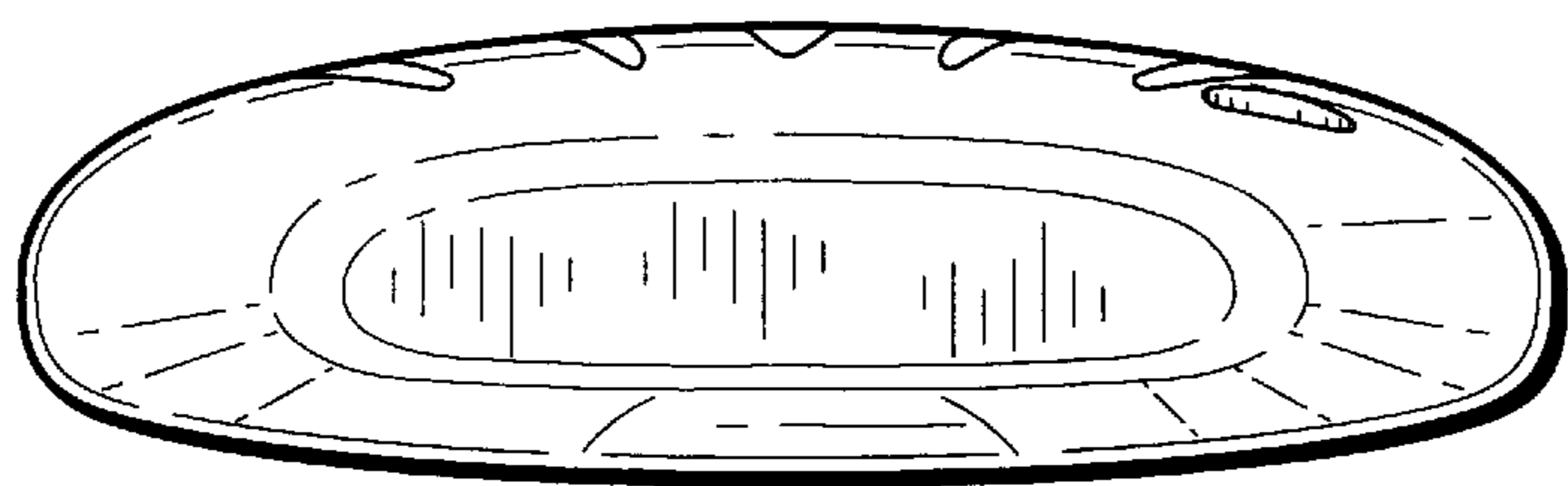

Fig. 5

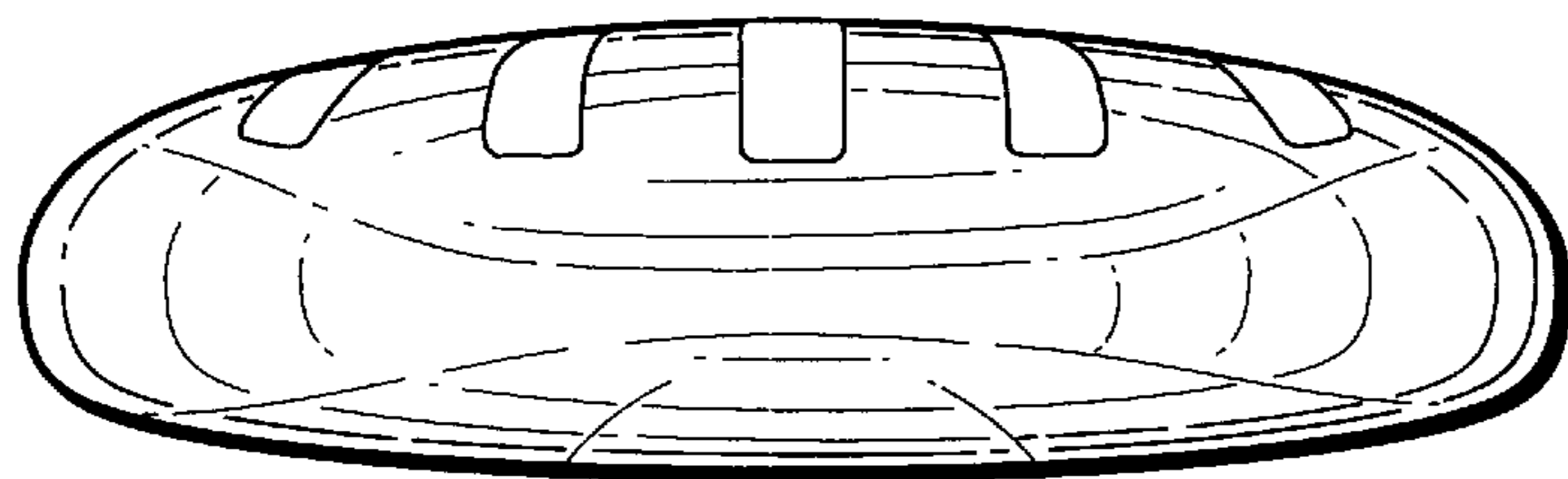

Fig. 6

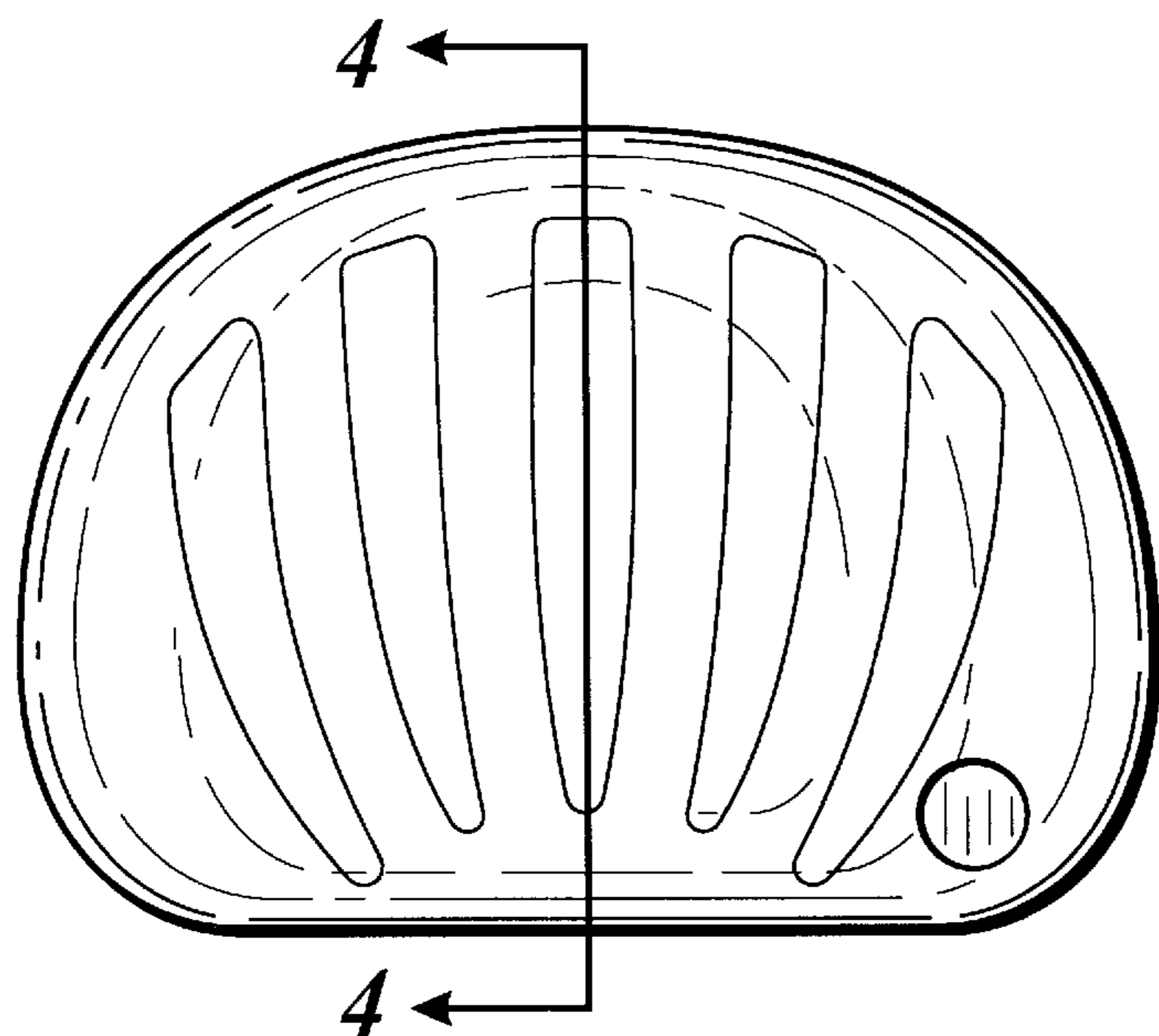

Fig. 7

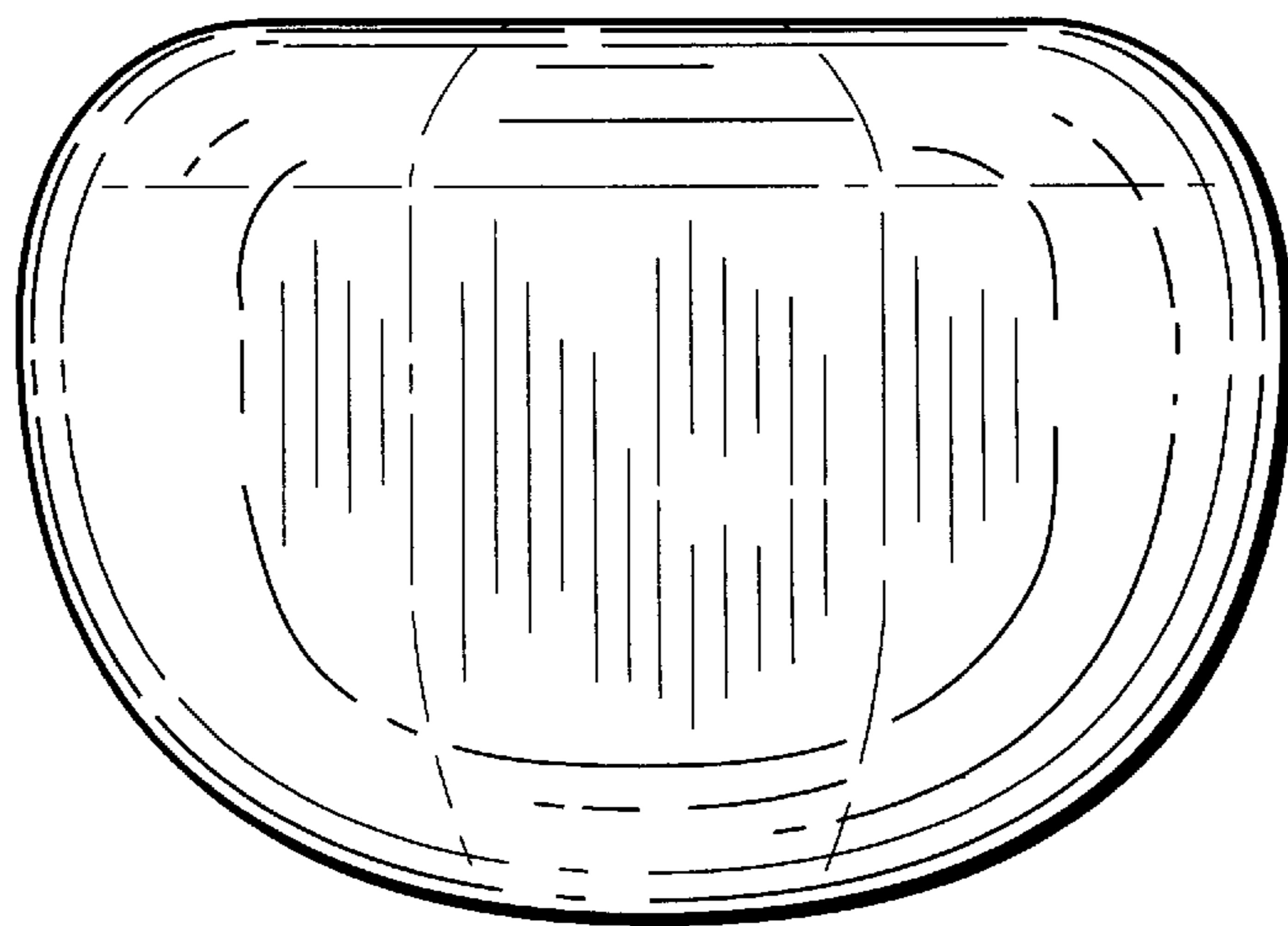

Fig. 8