



US00D405061S

# United States Patent [19]

Thomas

[11] **Patent Number:** **Des. 405,061**

[45] **Date of Patent:** **\*\*Feb. 2, 1999**

[54] **CONTROL FOR A CEILING FAN AND LIGHT**

[75] Inventor: **James Thomas**, Memphis, Tenn.

[73] Assignee: **Hunter Fan Company**, Memphis, Tenn.

[\*\*] Term: **14 Years**

[21] Appl. No.: **63,856**

[22] Filed: **Dec. 17, 1996**

[51] **LOC (6) Cl.** ..... **13-03**

[52] **U.S. Cl.** ..... **D13/170; D13/125; D13/171**

[58] **Field of Search** ..... **D13/125, 158, D13/162, 170, 171; 174/66; 200/5 A, 330; 338/92**

[56] **References Cited**

**U.S. PATENT DOCUMENTS**

D. 254,001	1/1980	Mayo	.....	D13/125
D. 301,873	6/1989	Gutman	.....	D13/171
D. 309,891	8/1990	Cheng	.....	D13/158
D. 335,283	5/1993	Justiniano et al.	.....	D13/171
5,191,971	3/1993	Hakkarainen et al.	.....	200/550

*Primary Examiner*—James Gandy  
*Assistant Examiner*—Cathron B. Matta

*Attorney, Agent, or Firm*—Baker, Donelson, Bearman & Caldwell

[57] **CLAIM**

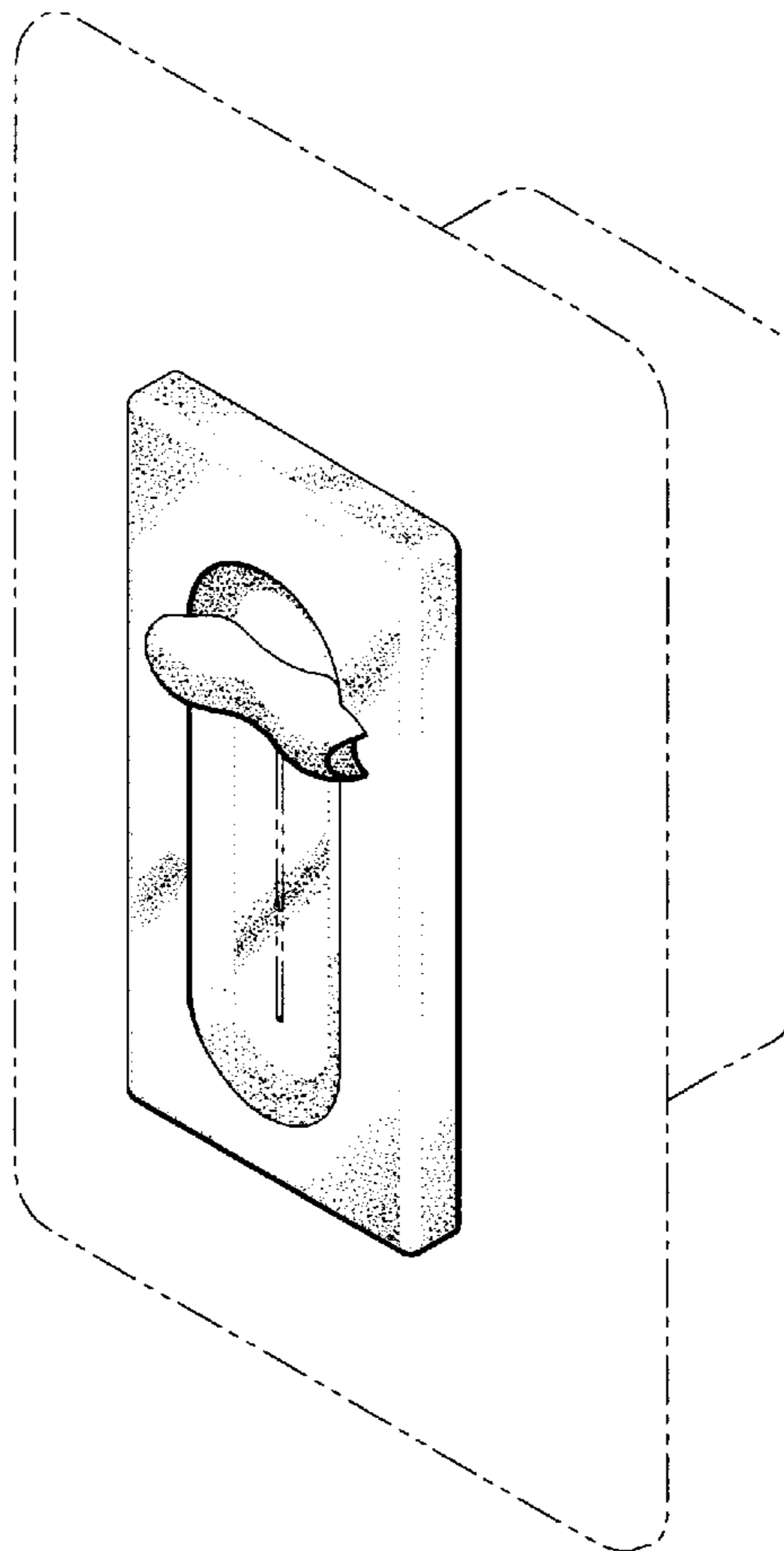
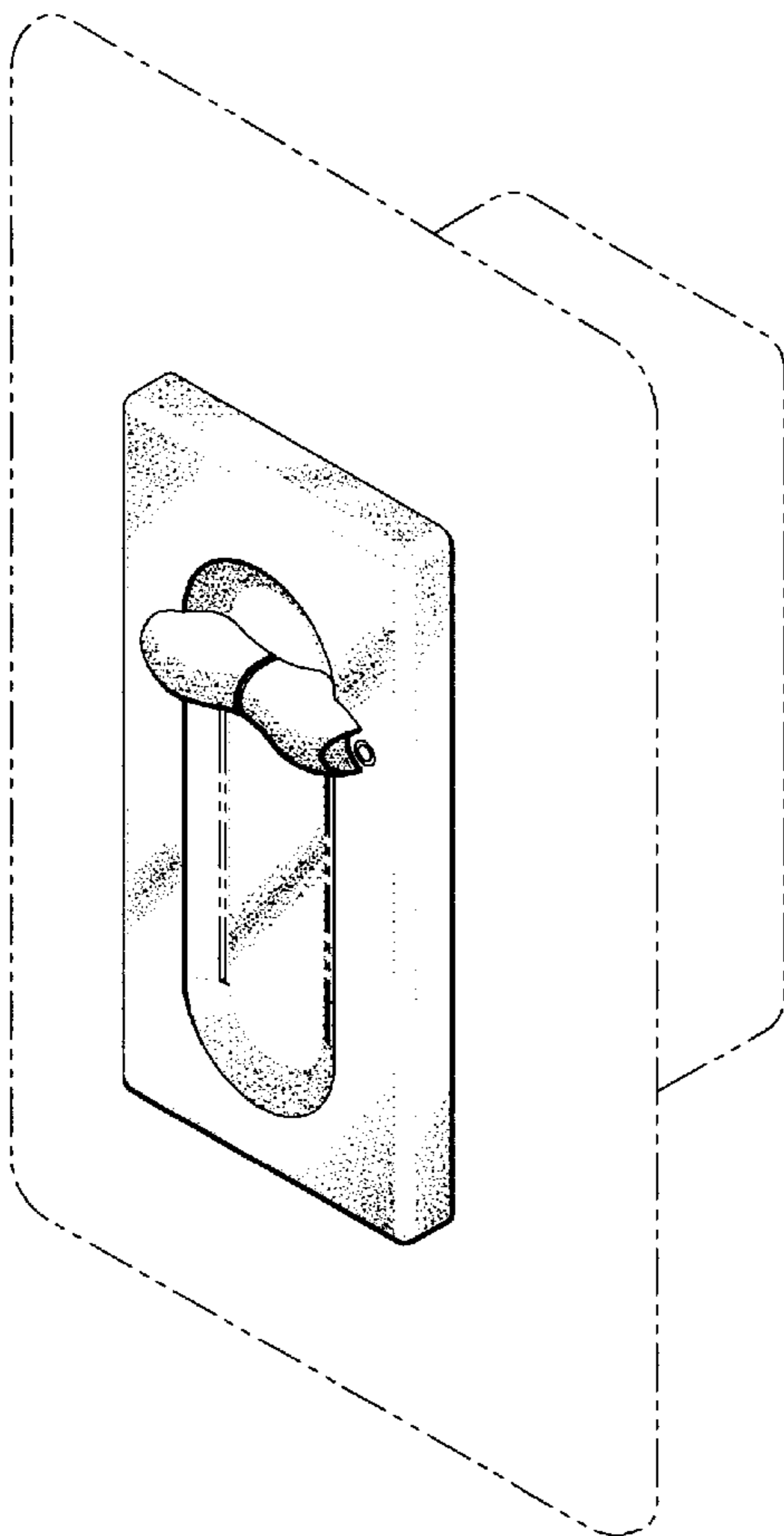
The ornamental design for a control for a ceiling fan and light, as shown and described..

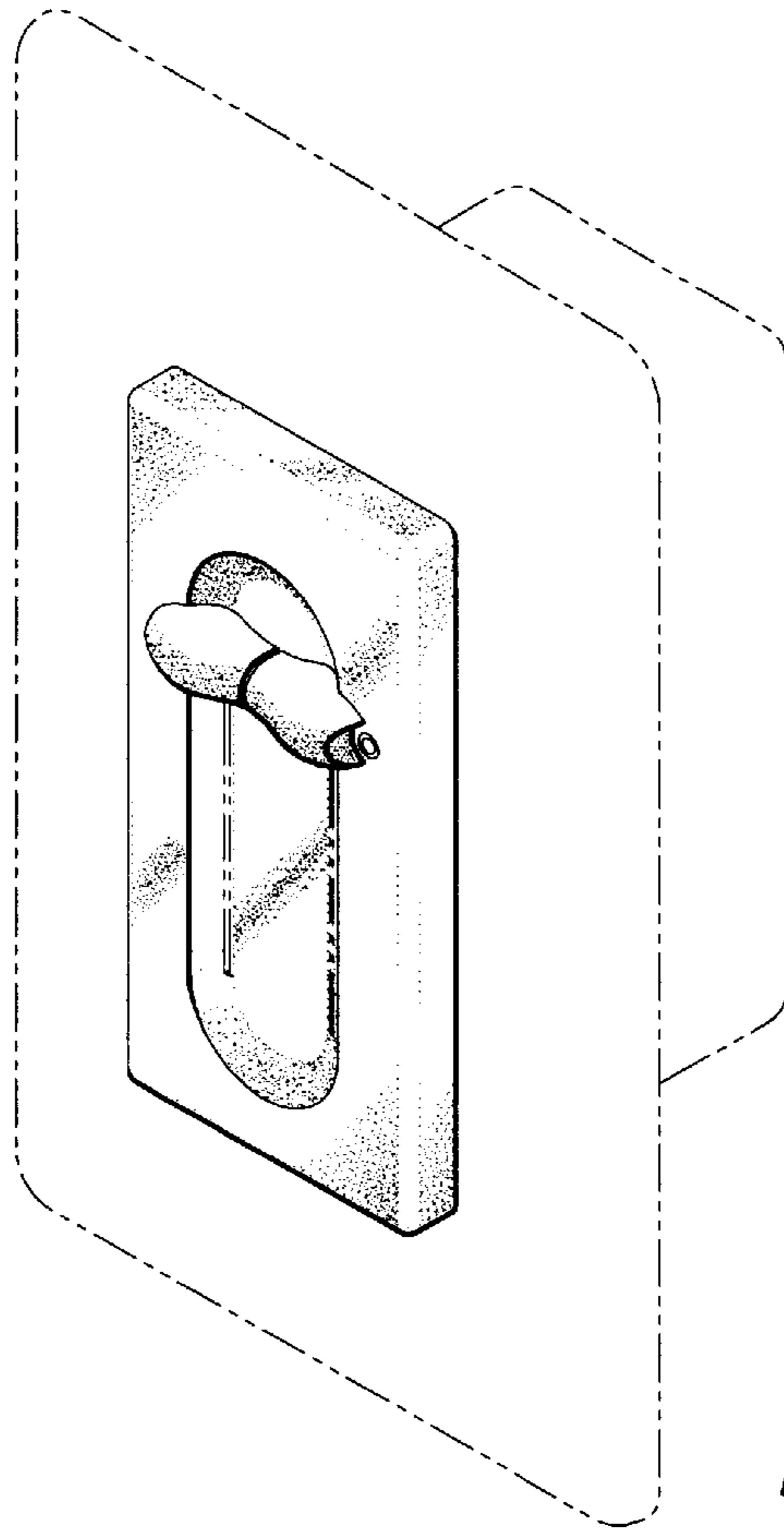
**DESCRIPTION**

FIG. 1 is a perspective view of a control for a ceiling fan and light showing my new design;  
FIG. 2 is a front view thereof;  
FIG. 3 is a right side view thereof;  
FIG. 4 is a rear view thereof;  
FIG. 5 is a left side view thereof;  
FIG. 6 is a top view thereof;  
FIG. 7 is a bottom view thereof;  
FIG. 8 is a perspective view of a control for a ceiling fan and light showing a second embodiment of my new design;  
FIG. 9 is a front view thereof;  
FIG. 10 is a right side view thereof;  
FIG. 11 is a rear view thereof;  
FIG. 12 is a left side view thereof;  
FIG. 13 is a top view thereof; and,  
FIG. 14 is a bottom view thereof.

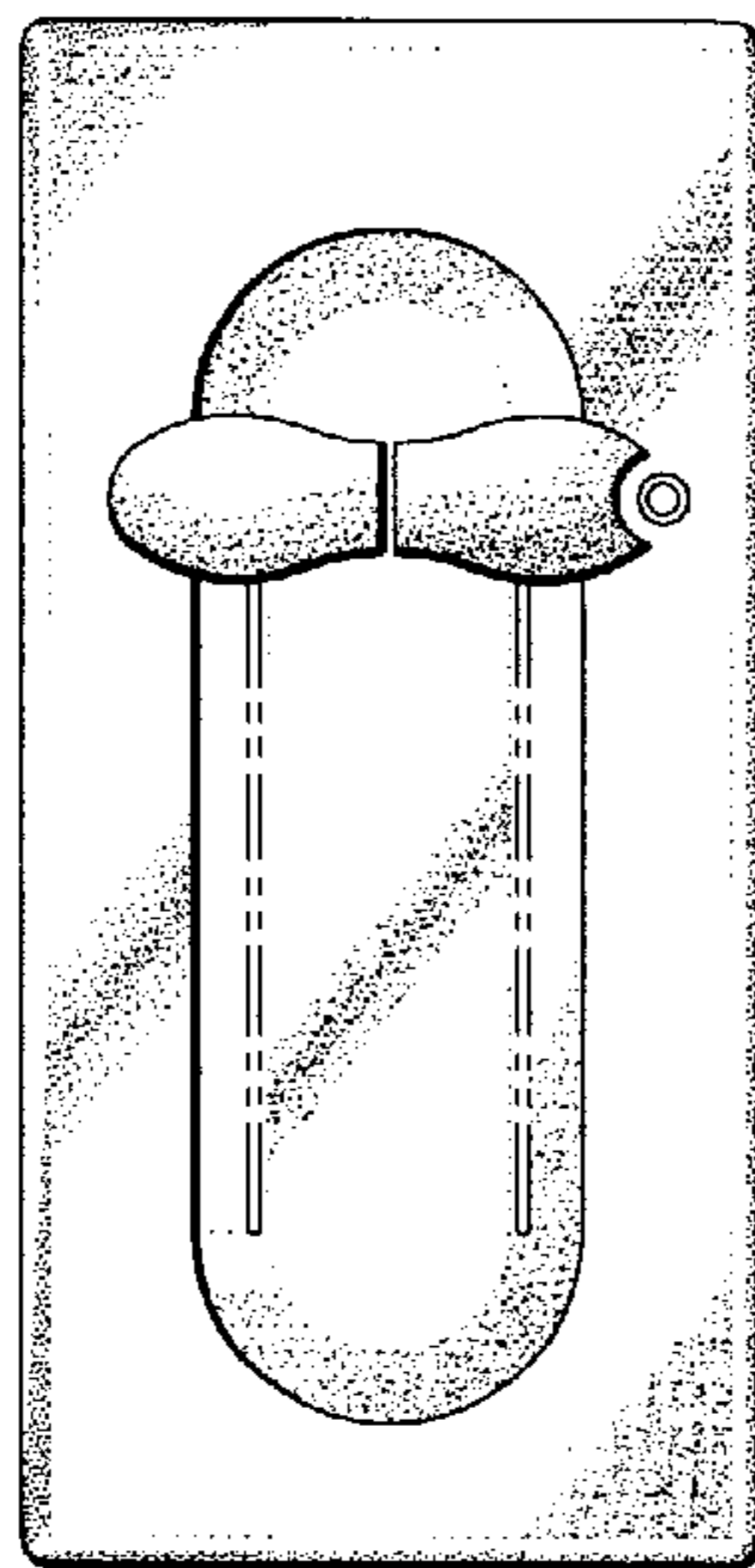
The broken lines in FIGS. 1, 2, 8 and 9 are illustrative of environmental structure only and form no part of the claimed design.

**1 Claim, 4 Drawing Sheets**

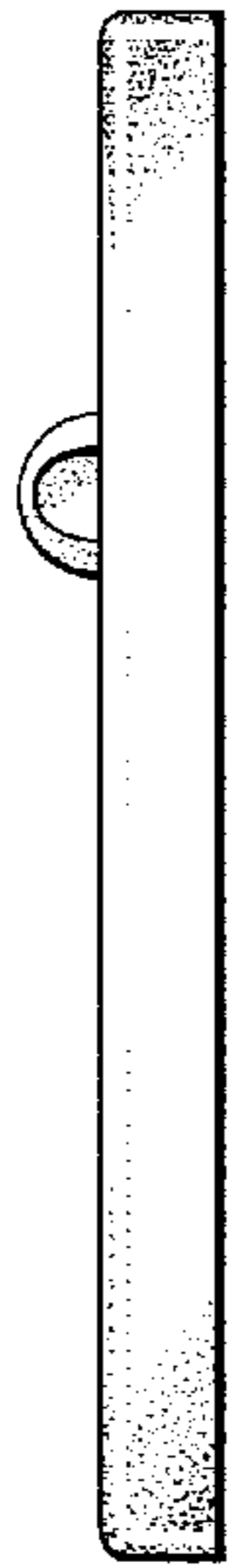




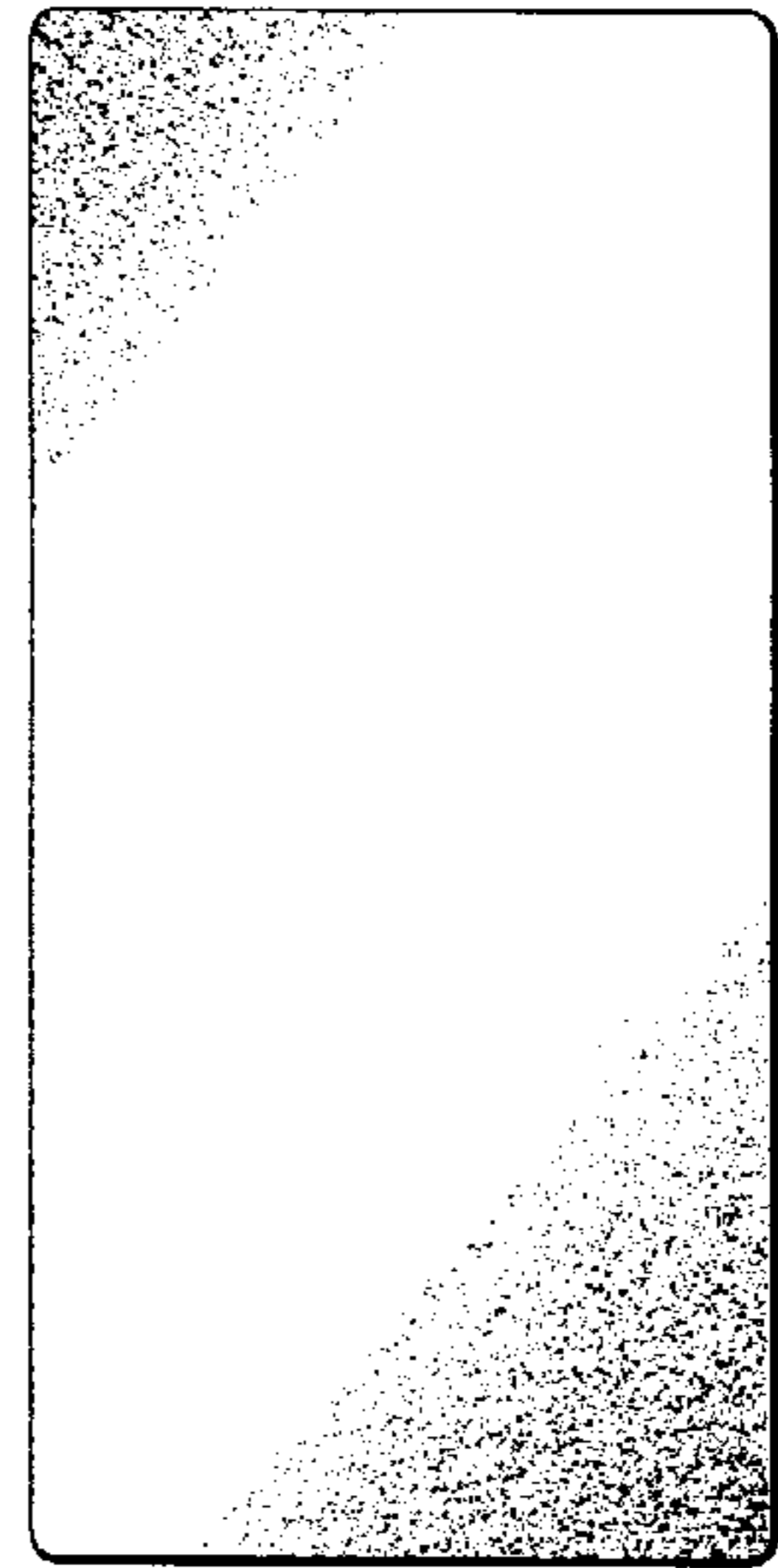
**FIG 1**



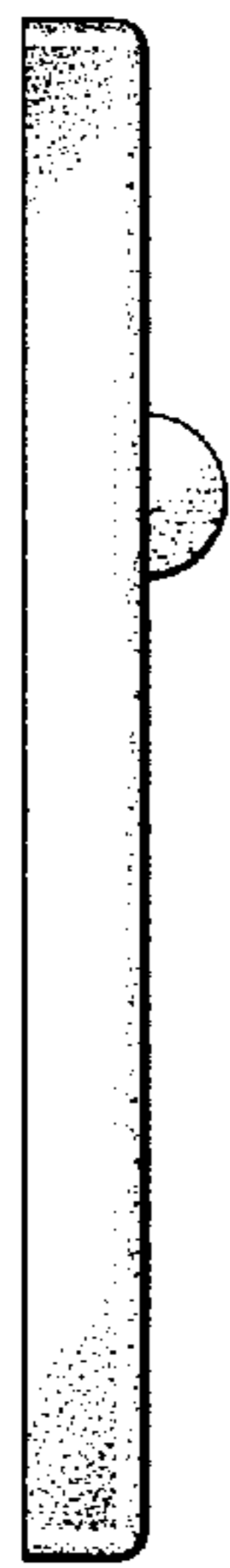
**FIG 2**



**FIG 3**



**FIG 4**



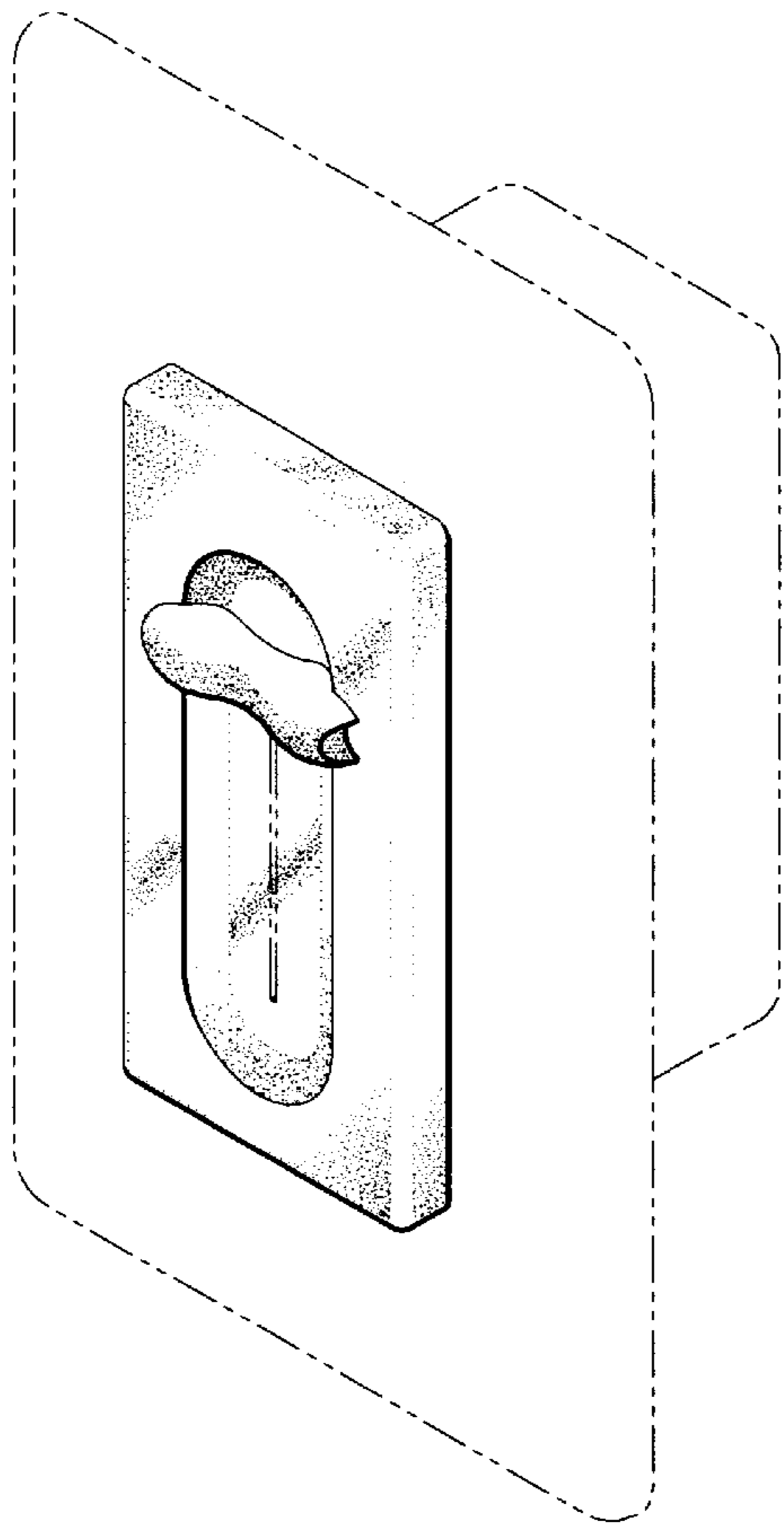
**FIG 5**



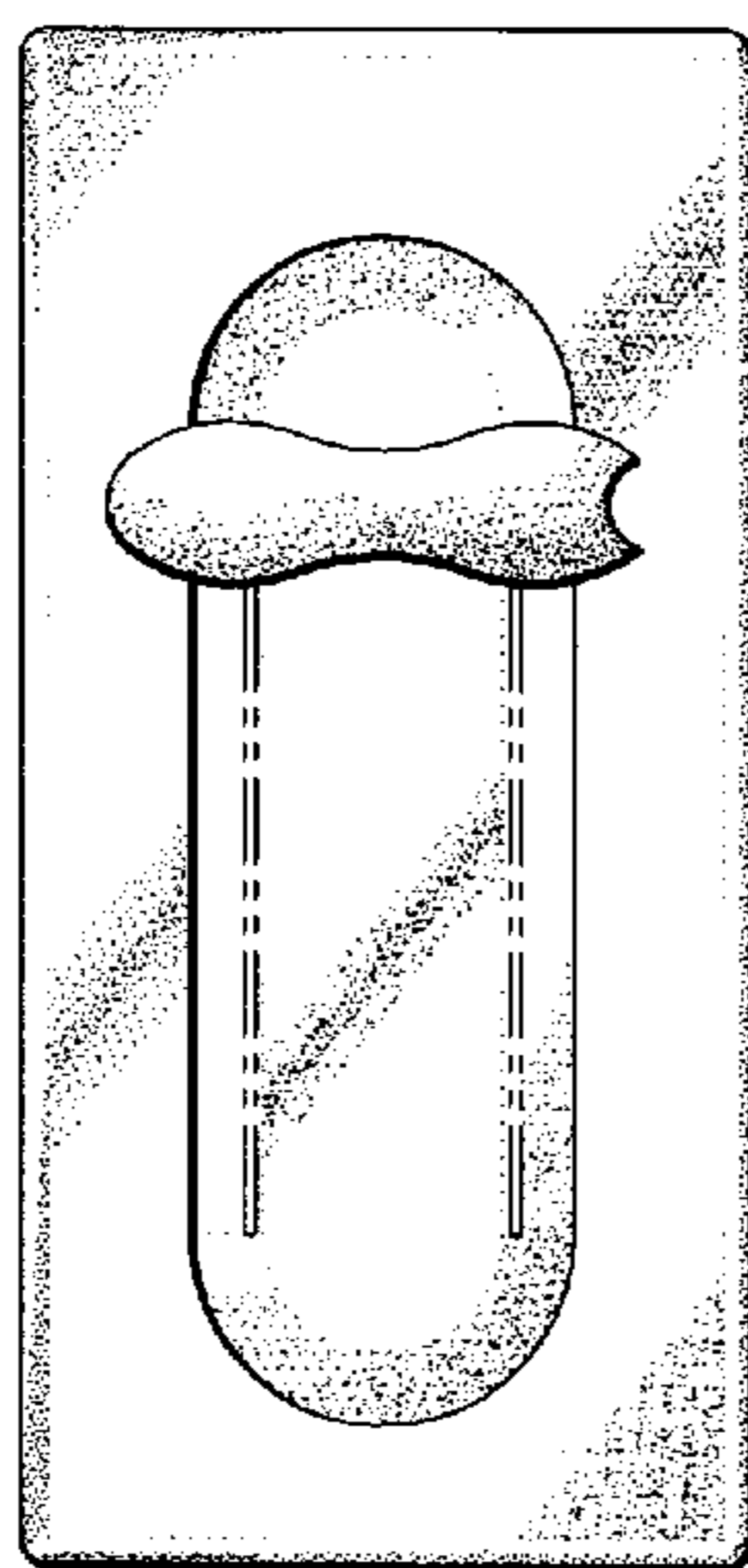
**FIG 6**



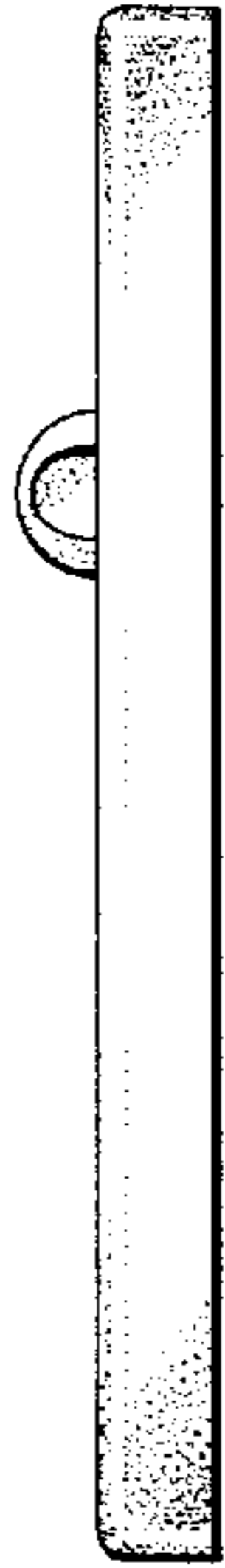
**FIG 7**



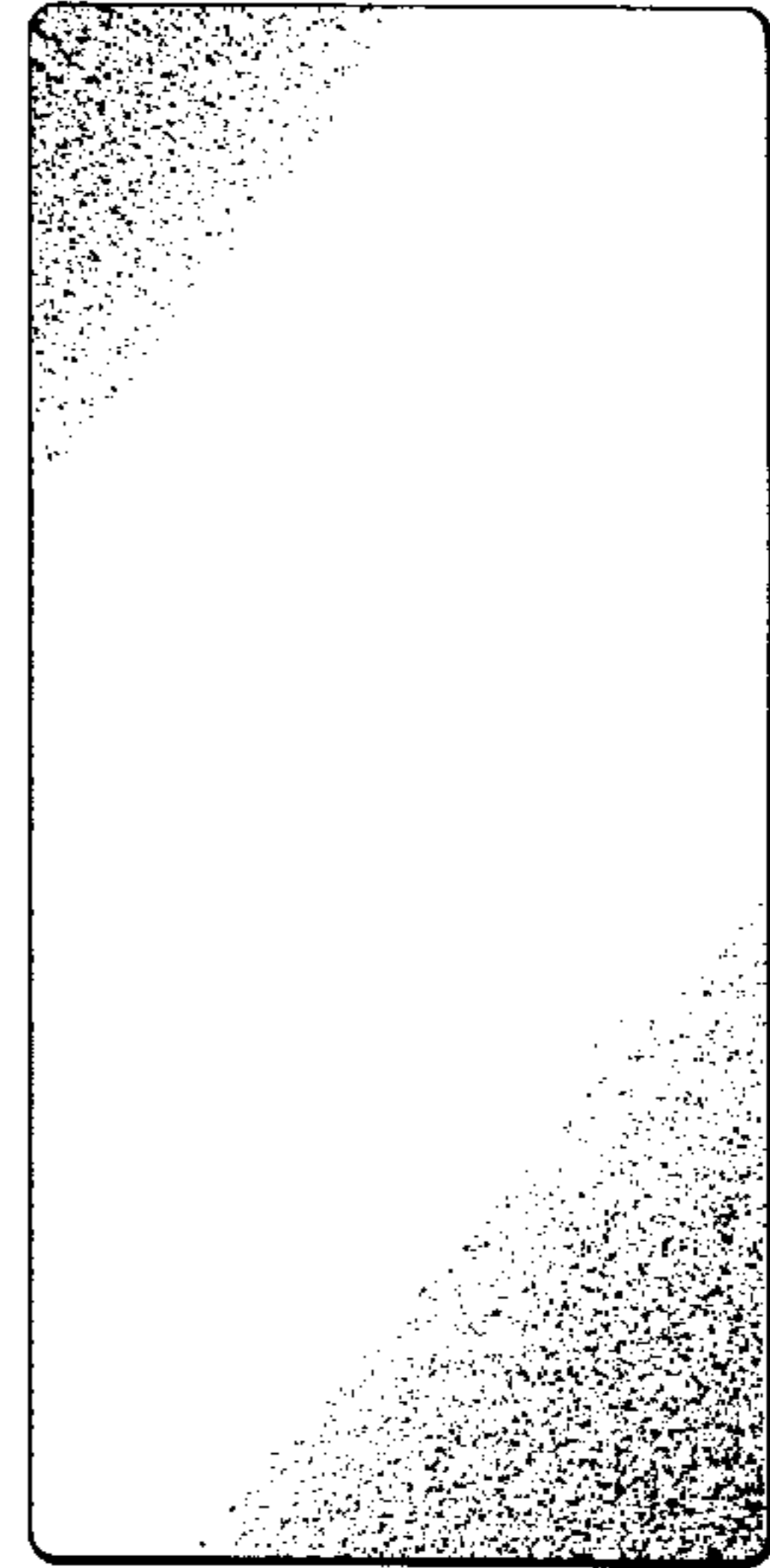
**FIG 8**



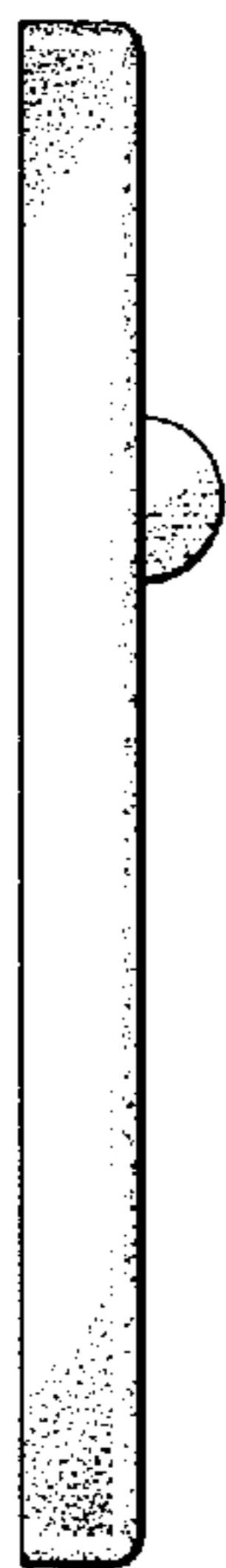
**FIG 9**



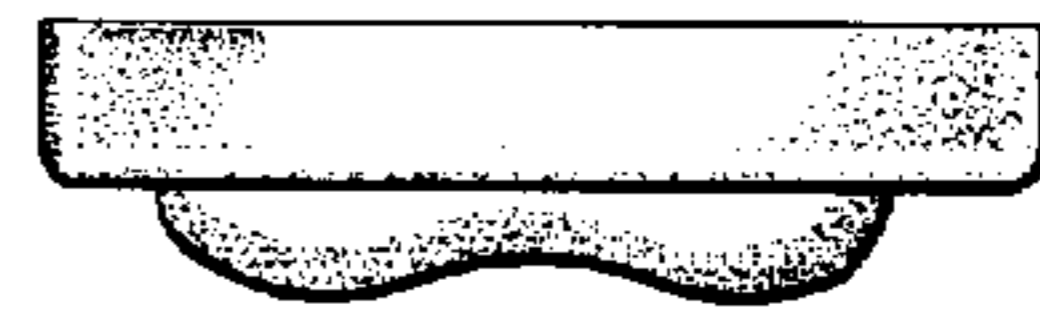
**FIG 10**



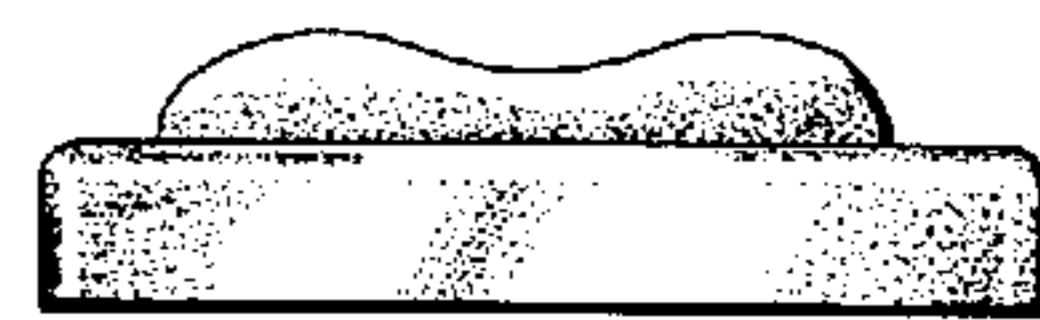
**FIG 11**



**FIG 12**



**FIG 13**



**FIG 14**