



US00D404974S

# United States Patent [19]

Kristinik

[11] Patent Number: **Des. 404,974**

[45] Date of Patent: **\*\*Feb. 2, 1999**

[54] **COMBINATION HOT OR COLD BEVERAGE/  
CAN HOLDER**

[76] Inventor: **Elgin R. Kristinik**, P.O. Box 402,  
Schulenburg, Tex. 78956

[\*\*] Term: **14 Years**

[21] Appl. No.: **56,729**

[22] Filed: **Jul. 8, 1996**

[51] **LOC (6) Cl.** ..... **07-06**

[52] **U.S. Cl.** ..... **D7/608**

[58] **Field of Search** ..... D7/605-608, 619-625;  
220/737, 739, 903; 62/457.1, 457.3, 457.4;  
215/392-394

[56] **References Cited**

**U.S. PATENT DOCUMENTS**

- D. 258,483 3/1981 Weinstein .
- D. 285,656 9/1986 Champion .
- D. 290,323 6/1987 Weernink .
- D. 321,457 11/1991 Kahl .
- D. 322,218 12/1991 Lynd .
- D. 322,224 12/1991 Miner .
- D. 337,271 7/1993 Pezzoli et al. .
- D. 338,831 8/1993 Osip et al. .
- D. 338,832 8/1993 Osip et al. .
- D. 340,836 11/1993 Cautereels .
- D. 347,973 6/1994 McBride .
- D. 348,176 6/1994 Sokolski et al. .
- D. 349,218 8/1994 Evans .

- D. 354,202 1/1995 Smith et al. .
- 1,381,071 6/1921 Flannery ..... 220/903 X
- 2,115,654 4/1938 Swofford ..... 220/903 X
- 3,285,455 11/1966 Pewitt ..... 220/903 X
- 4,462,444 7/1984 Larson ..... 220/903 X
- 4,720,023 1/1988 Jeff ..... 220/739 X
- 4,790,444 12/1988 Terzi .
- 5,467,891 11/1995 Perry ..... 220/739

*Primary Examiner*—Terry A. Wallace  
*Attorney, Agent, or Firm*—Kuffner & Associates

[57] **CLAIM**

The ornamental design for a combination hot or cold beverage/can holder, as shown and described.

**DESCRIPTION**

FIG. 1 is a perspective view of a combination hot or cold beverage/can holder showing my new design;  
 FIG. 2 is a side elevation view thereof;  
 FIG. 3 is a top plan view thereof;  
 FIG. 4 is a bottom plan view thereof;  
 FIG. 5 is a perspective view of an alternate embodiment of FIG. 1;  
 FIG. 6 is a side elevation view of an alternate embodiment of FIG. 1;  
 FIG. 7 is a top plan view of FIG. 5; and,  
 FIG. 8 is a bottom plan view of FIG. 5.  
 The broken lines showing the cans are for illustrative purposes only and form no part of the claimed design.

**1 Claim, 2 Drawing Sheets**

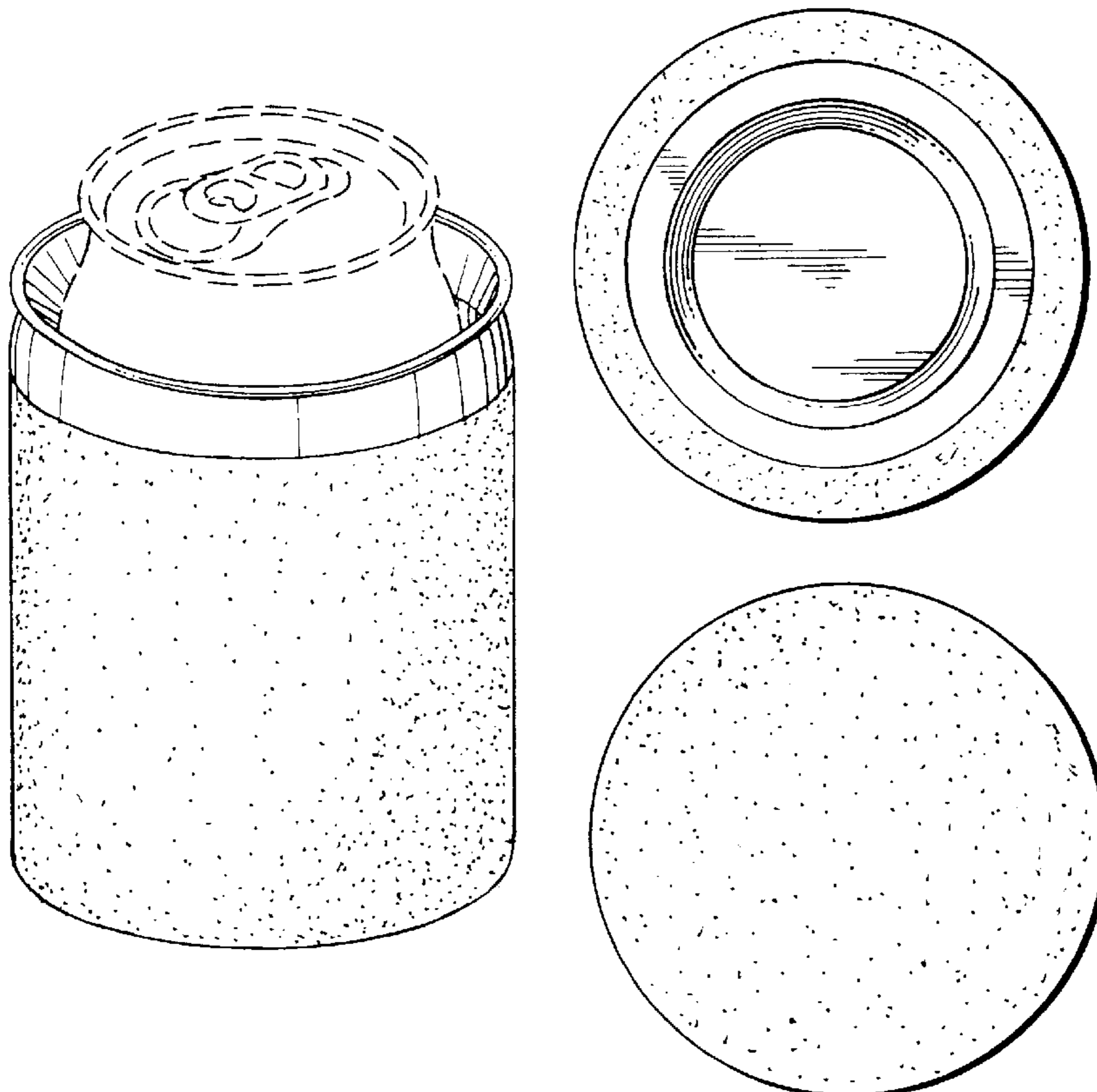

FIG. 1

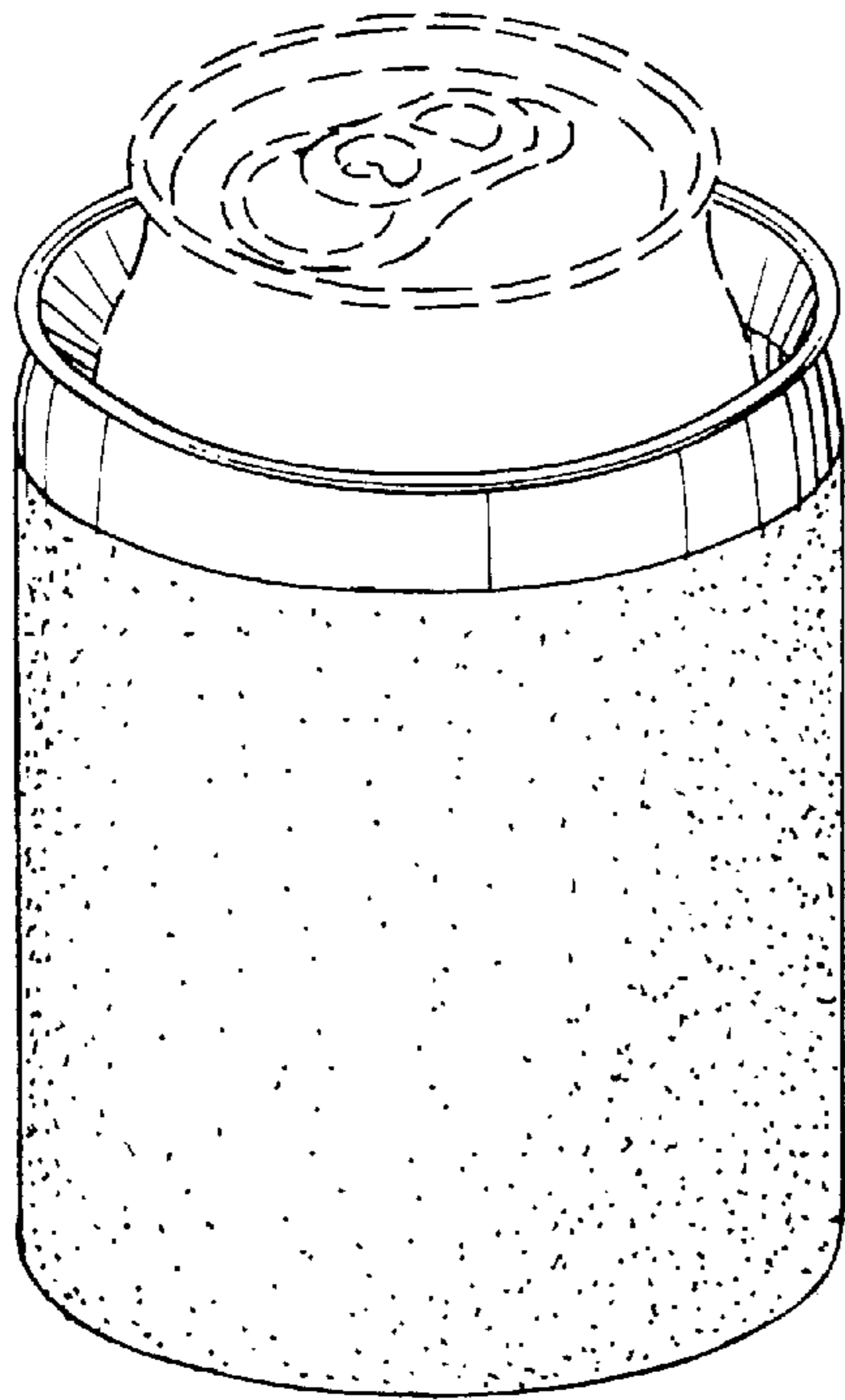

FIG. 2

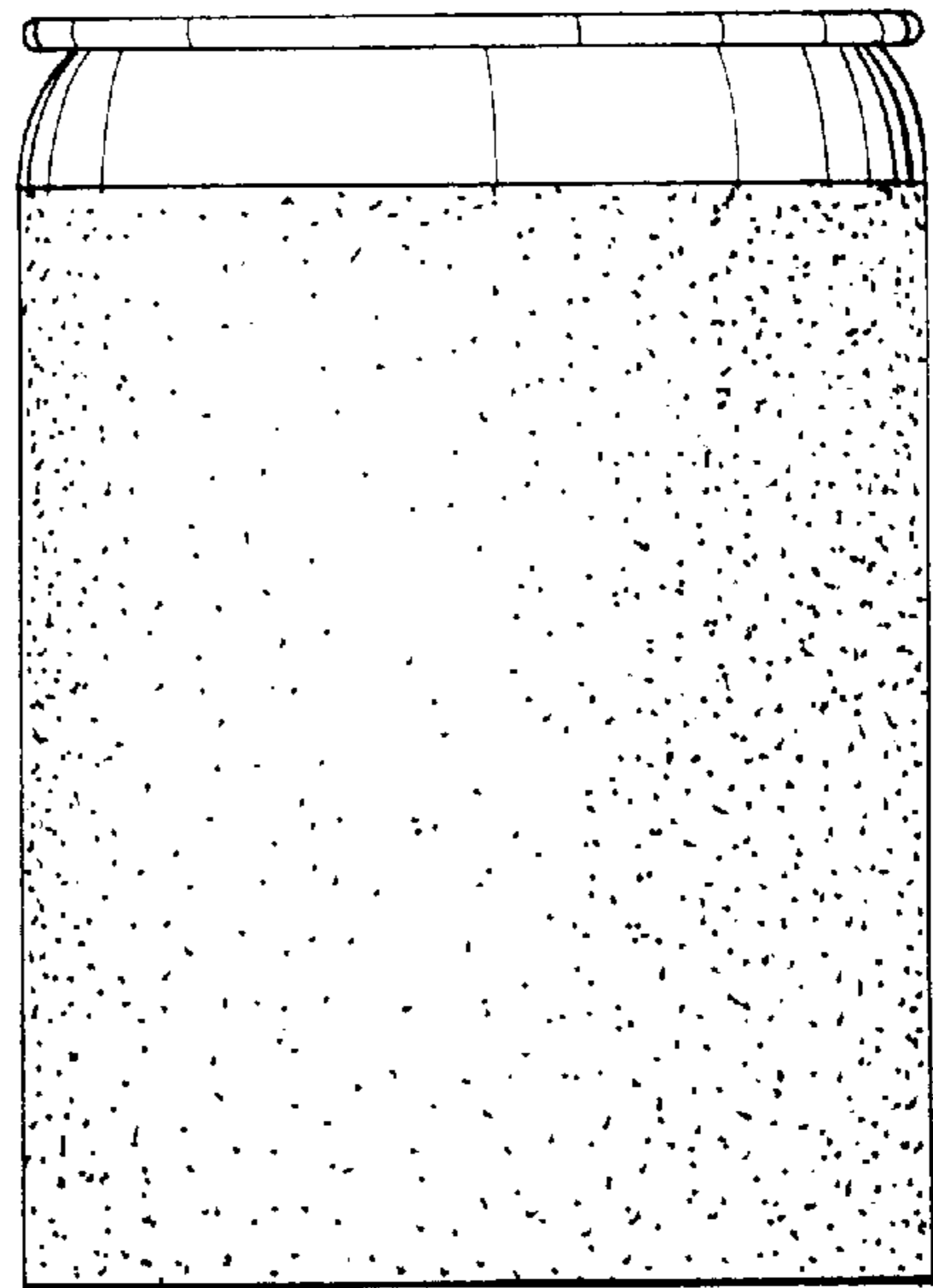

FIG. 3

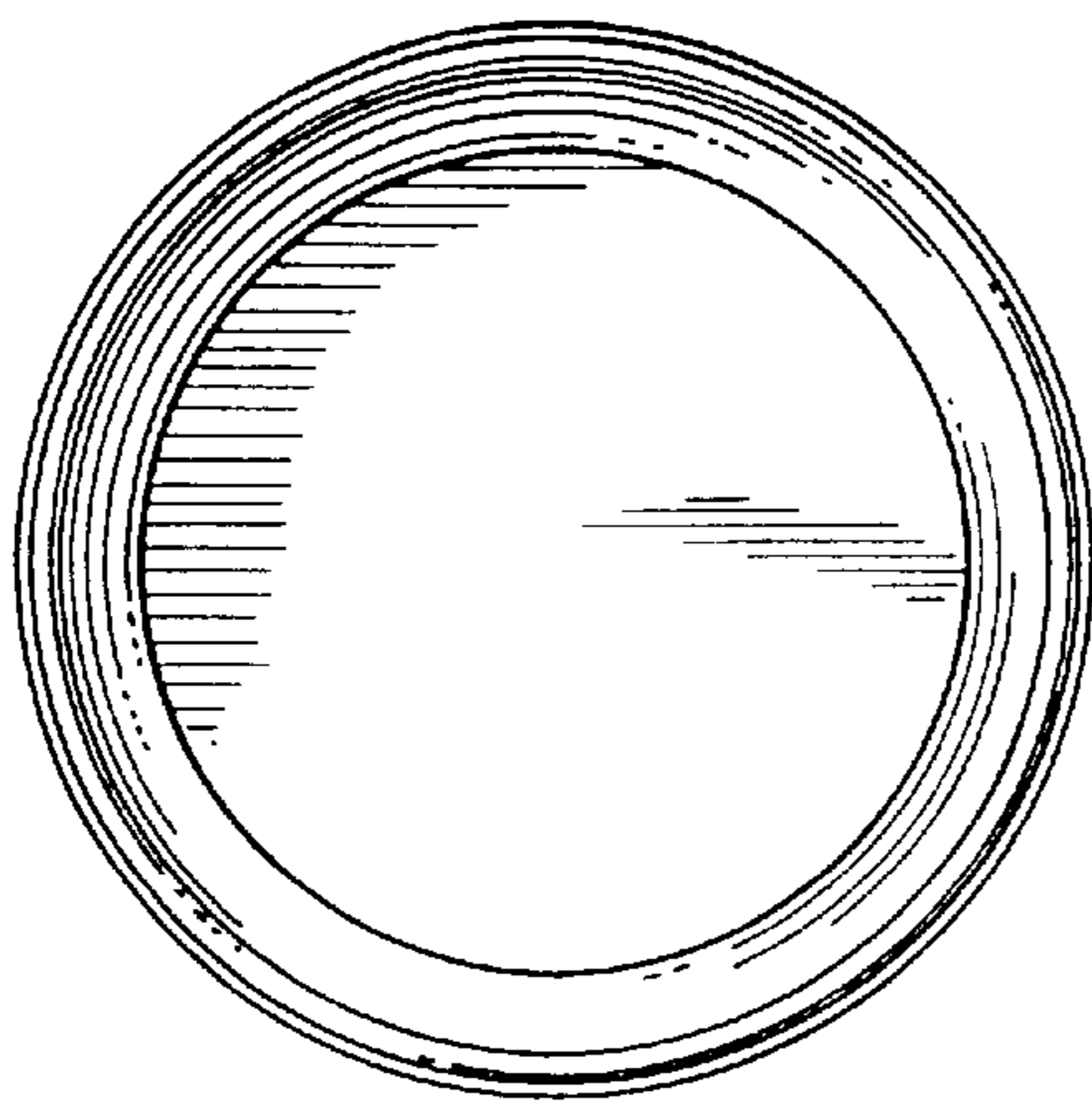

FIG. 4

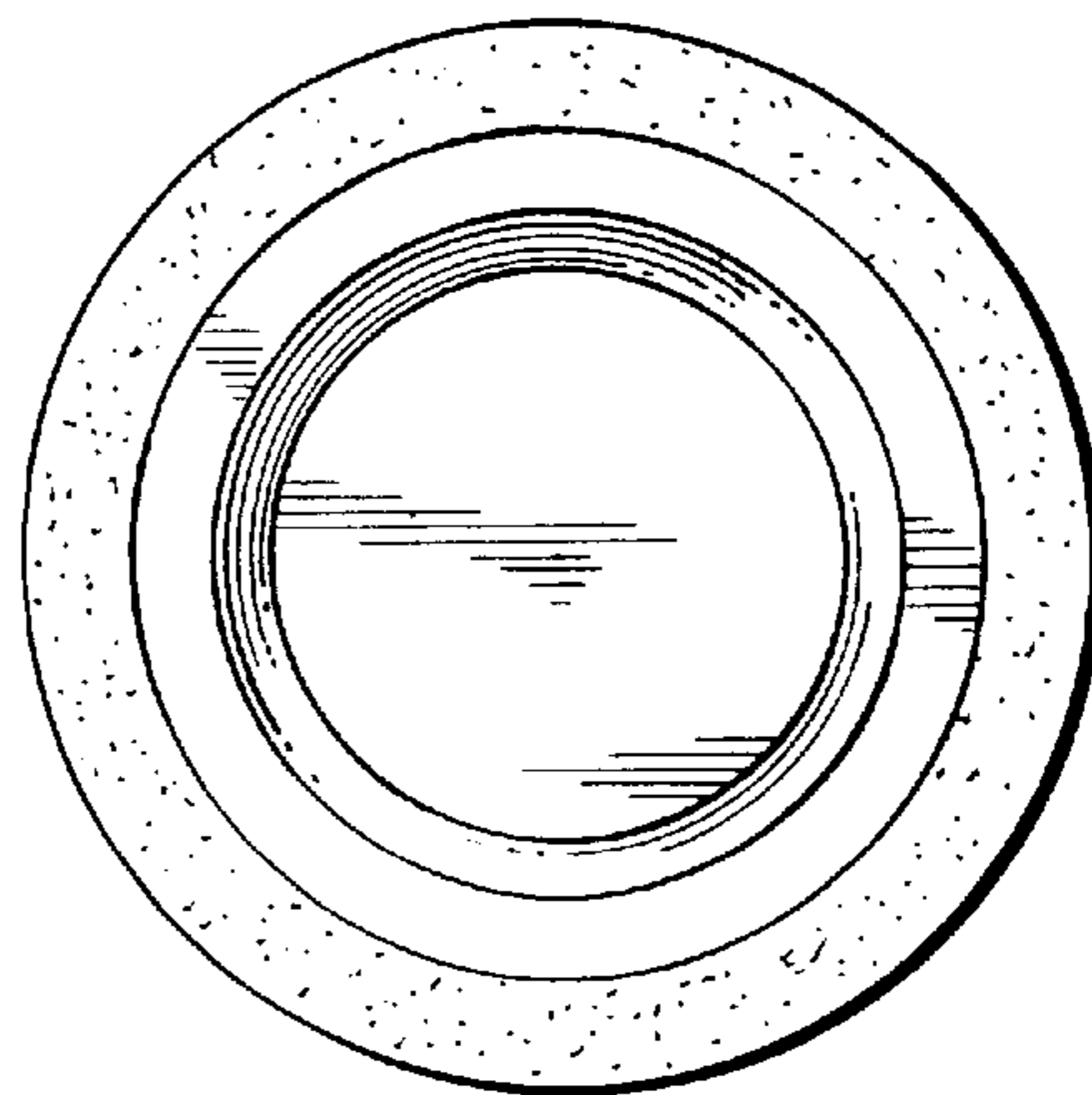

FIG. 5

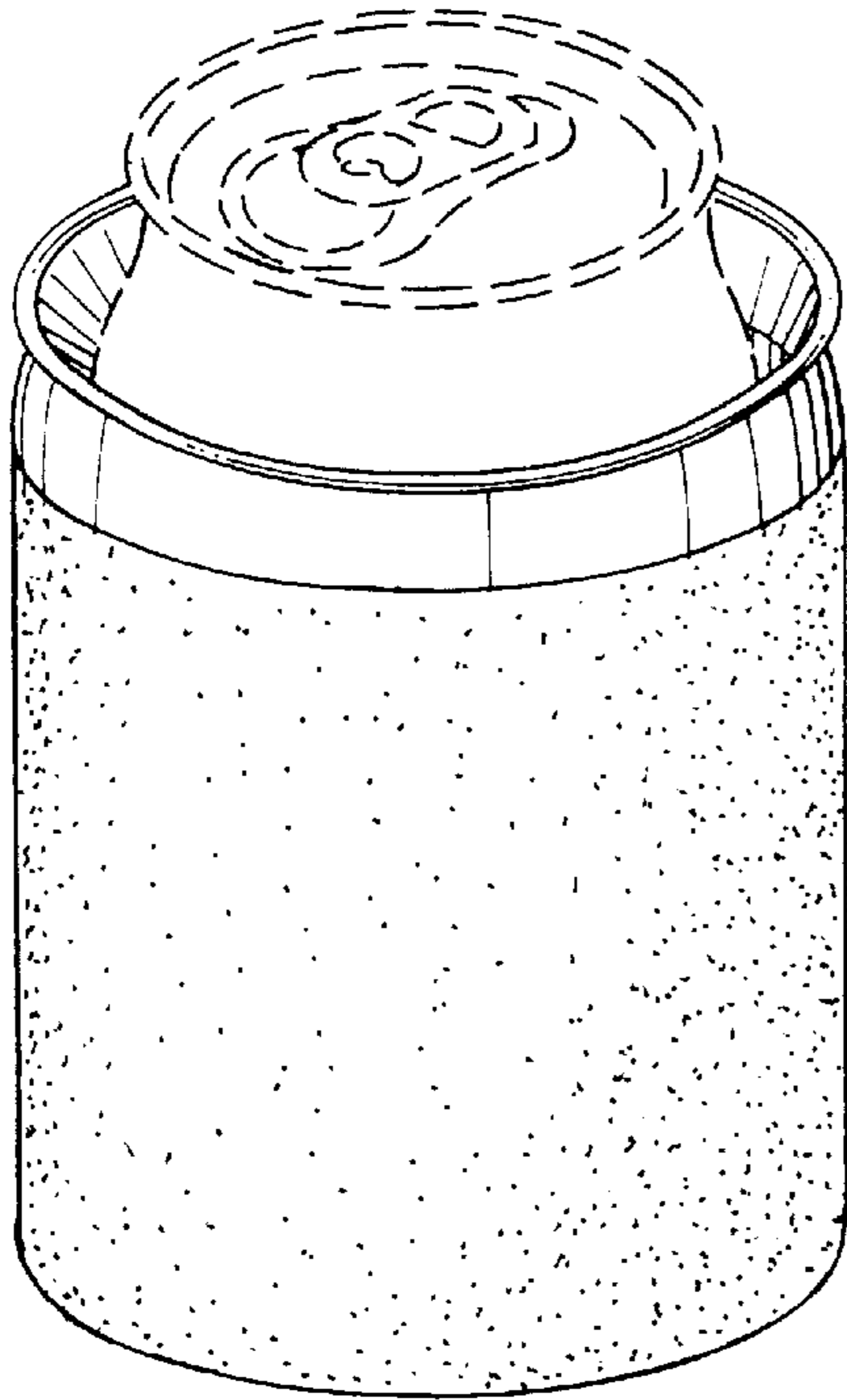

FIG. 6

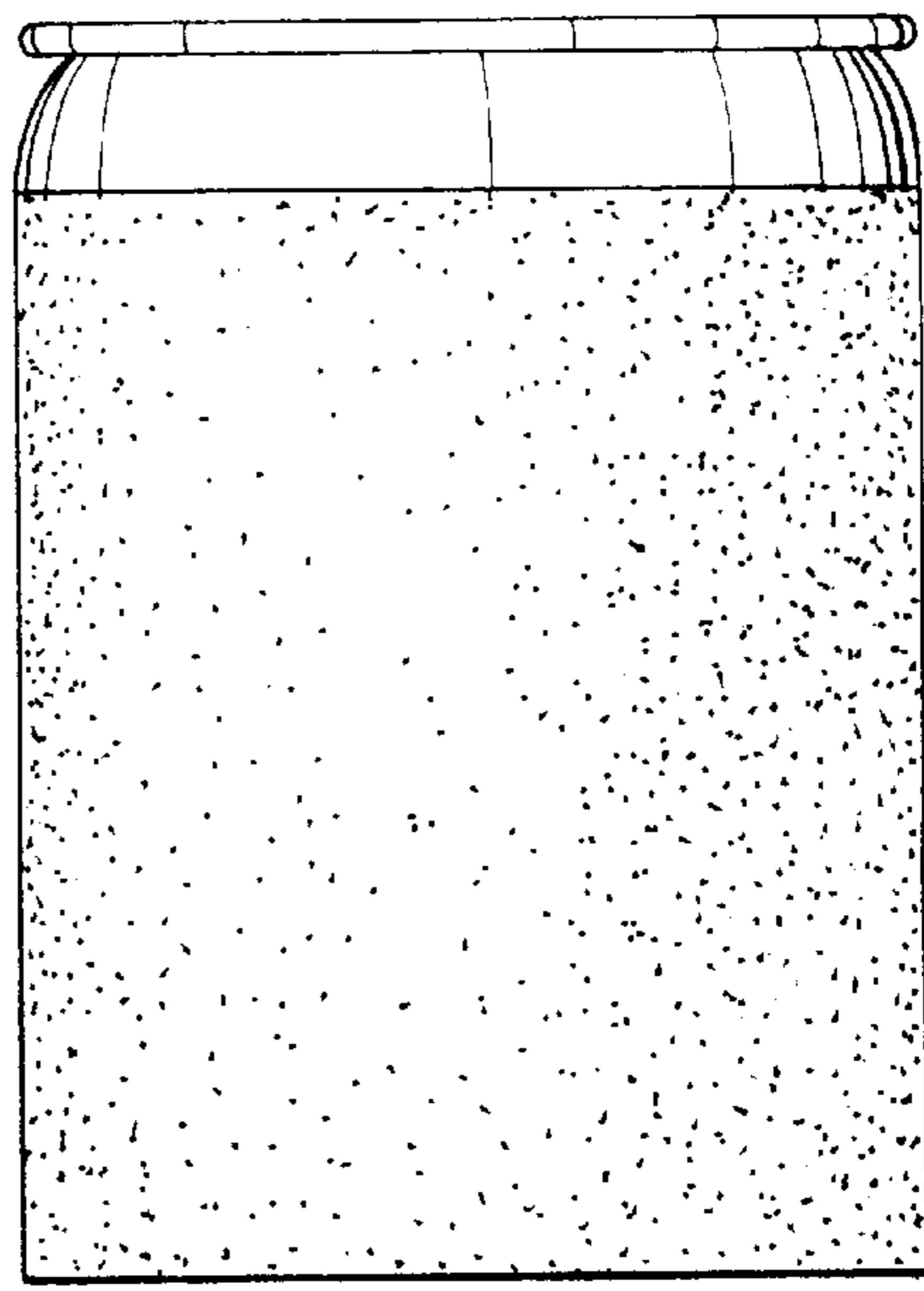

FIG. 7

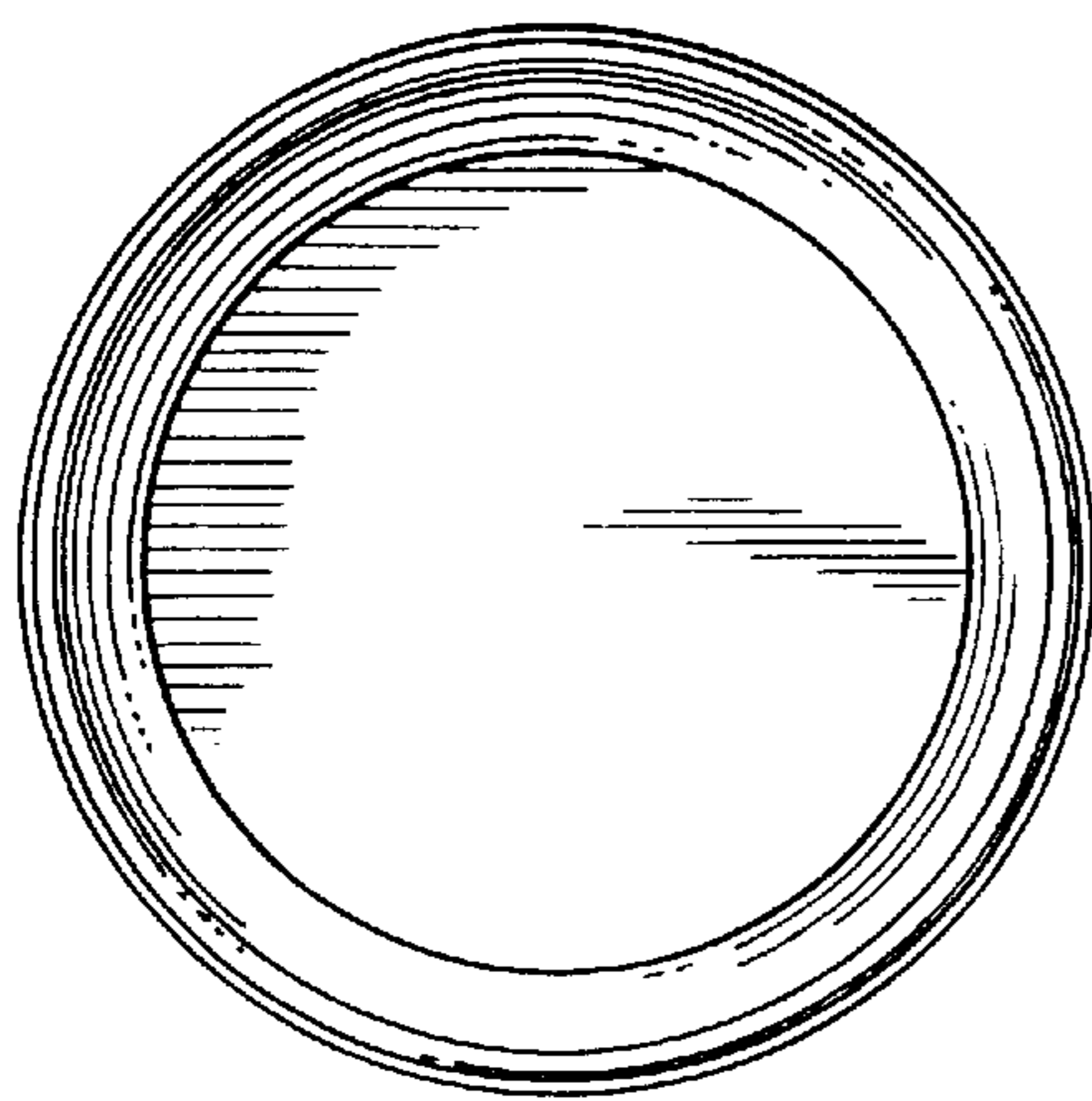

FIG. 8

