



US00D404947S

# United States Patent [19] Porcelli

[11] **Patent Number: Des. 404,947**

[45] **Date of Patent: \*\*Feb. 2, 1999**

[54] **TOWEL HOLDER**

[75] Inventor: **V. Lorenzo Porcelli**, Ossining, N.Y.

[73] Assignee: **M. Kamenstein, Inc.**, Elmsford, N.Y.

[\*\*] Term: **14 Years**

[21] Appl. No.: **78,300**

[22] Filed: **Oct. 24, 1997**

[51] **LOC (6) Cl. .... 07-07**

[52] **U.S. Cl. .... D6/522**

[58] **Field of Search ..... D6/518-523; 206/389; 242/590, 598, 601; 312/34.1, 34.8**

[56] **References Cited**

**U.S. PATENT DOCUMENTS**

- D. 240,682 7/1976 Robles ..... D6/521
- D. 260,828 9/1981 Cordray et al. .... D6/521
- D. 298,597 11/1988 Bell ..... D6/521
- D. 340,822 11/1993 Morand ..... D6/522

- D. 344,425 2/1994 Balanesi ..... D6/519
- D. 356,226 3/1995 Hay ..... D6/521
- 876,282 1/1908 Parmenter ..... D6/523 X

*Primary Examiner*—Brian N. Vinson  
*Attorney, Agent, or Firm*—Robert A. Koons, Jr.; James W. Bolcsak, Ph.D.

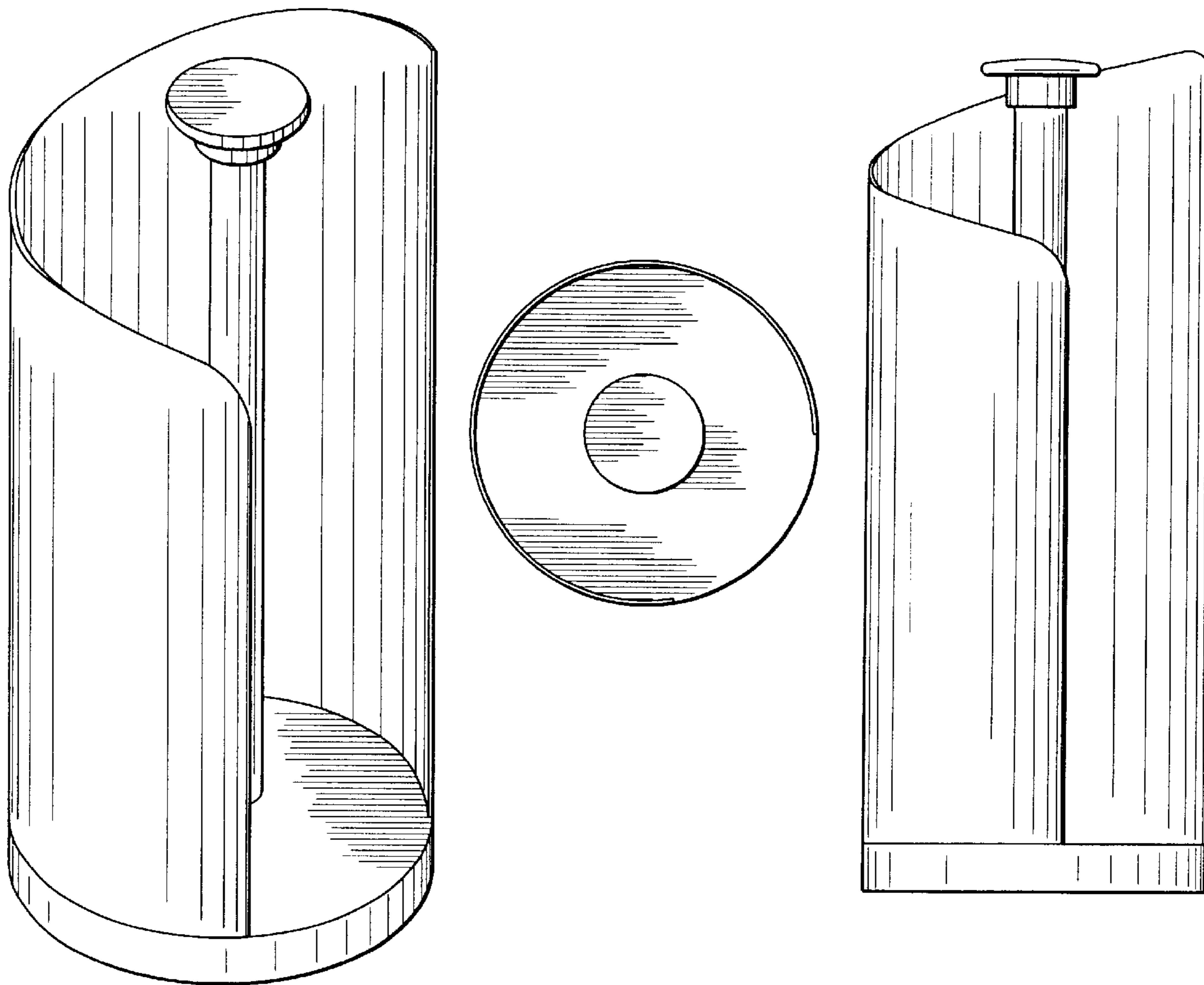
[57] **CLAIM**

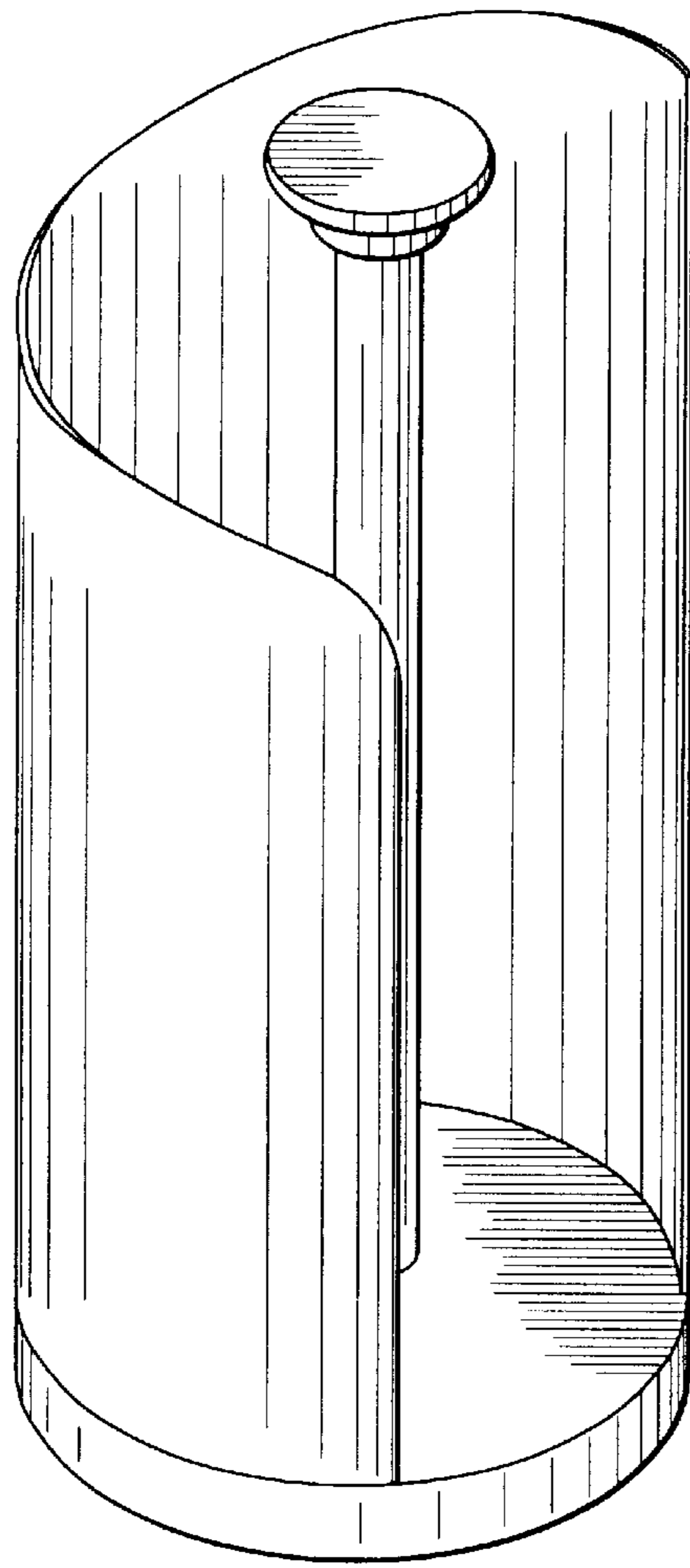
The ornamental design for a towel holder, as shown.

**DESCRIPTION**

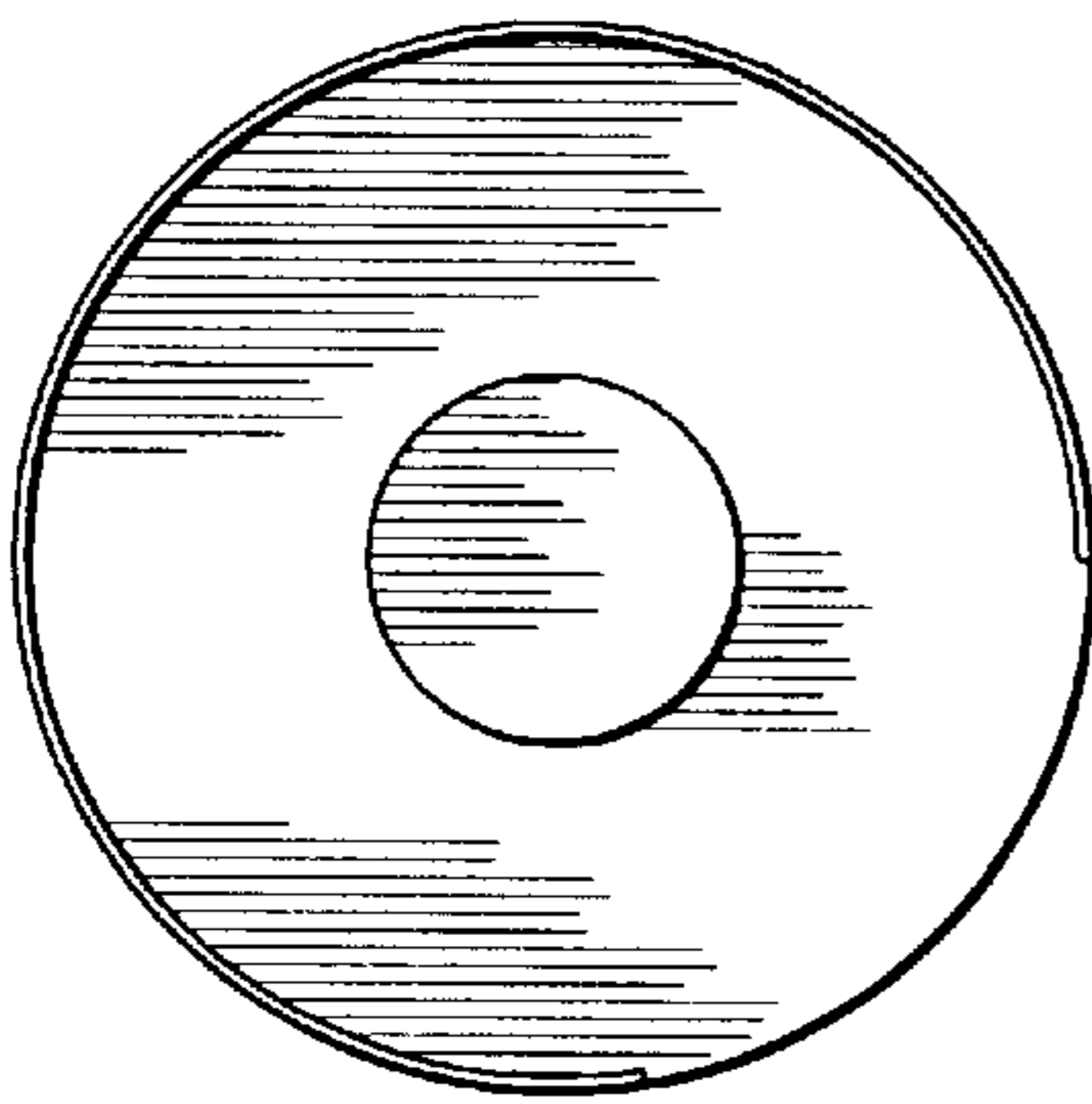
FIG. 1 is a perspective view of a towel holder showing my new design;  
FIG. 2 is a top side view thereof;  
FIG. 3 is a bottom side view thereof;  
FIG. 4 is a front side view thereof;  
FIG. 5 is a back side view thereof;  
FIG. 6 is a right side view thereof; and,  
FIG. 7 is a left side view thereof.

**1 Claim, 2 Drawing Sheets**

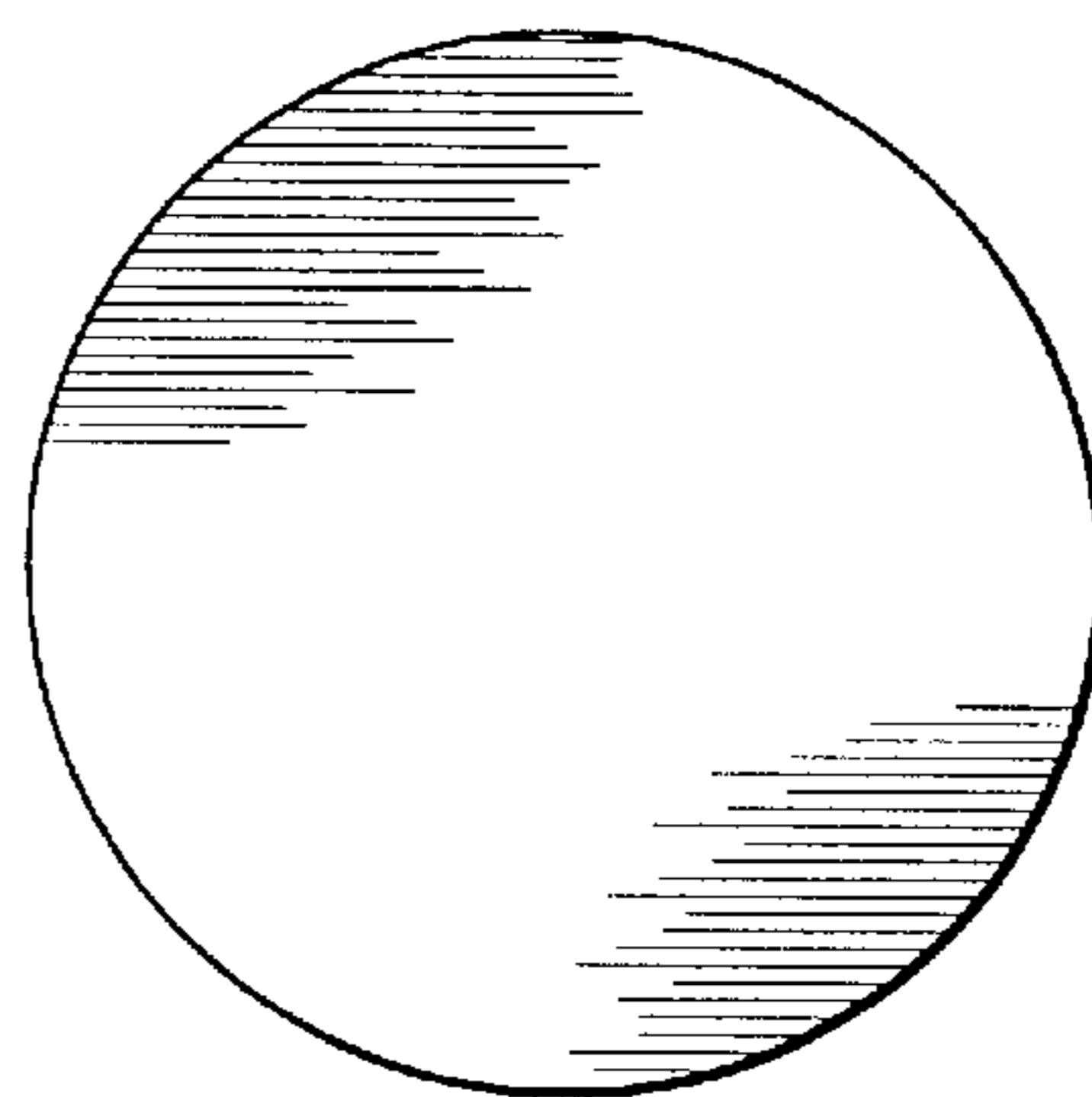




*FIG. 1*



*FIG. 2*



*FIG. 3*

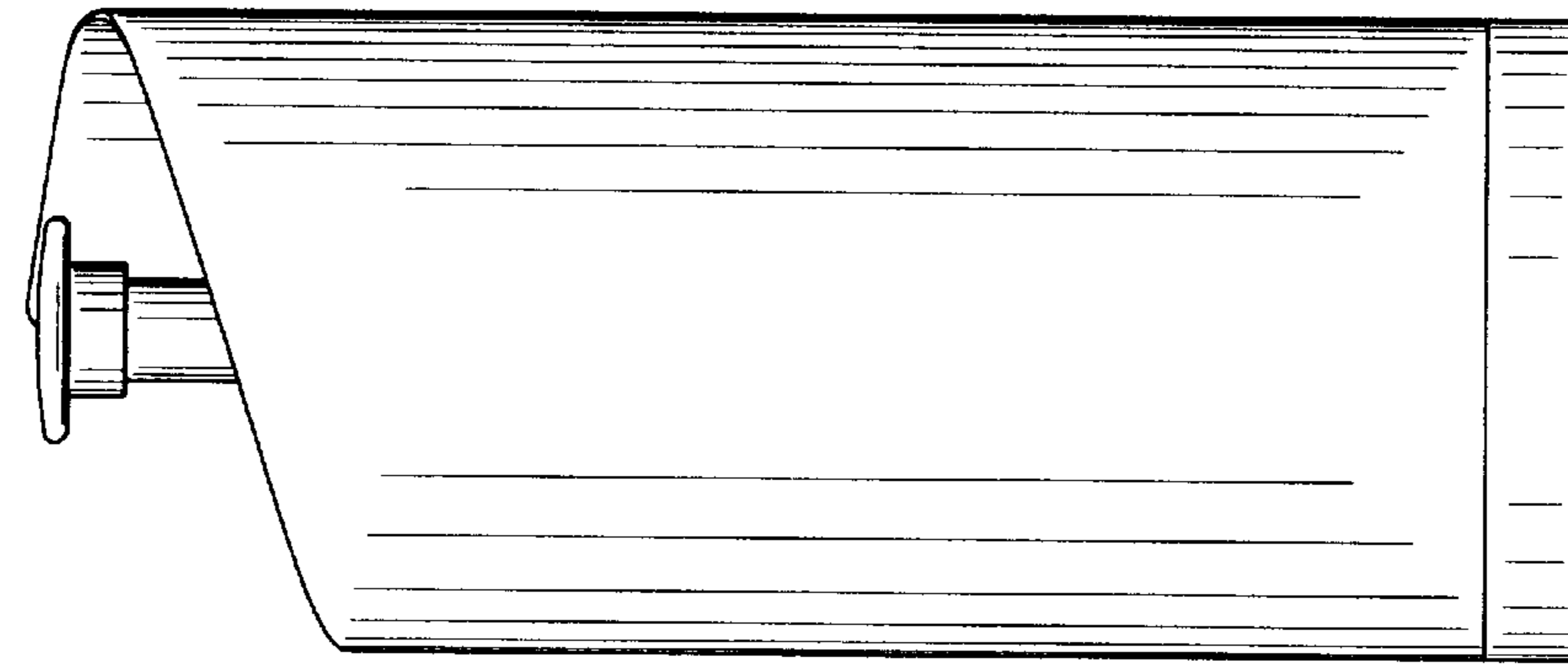


FIG. 4

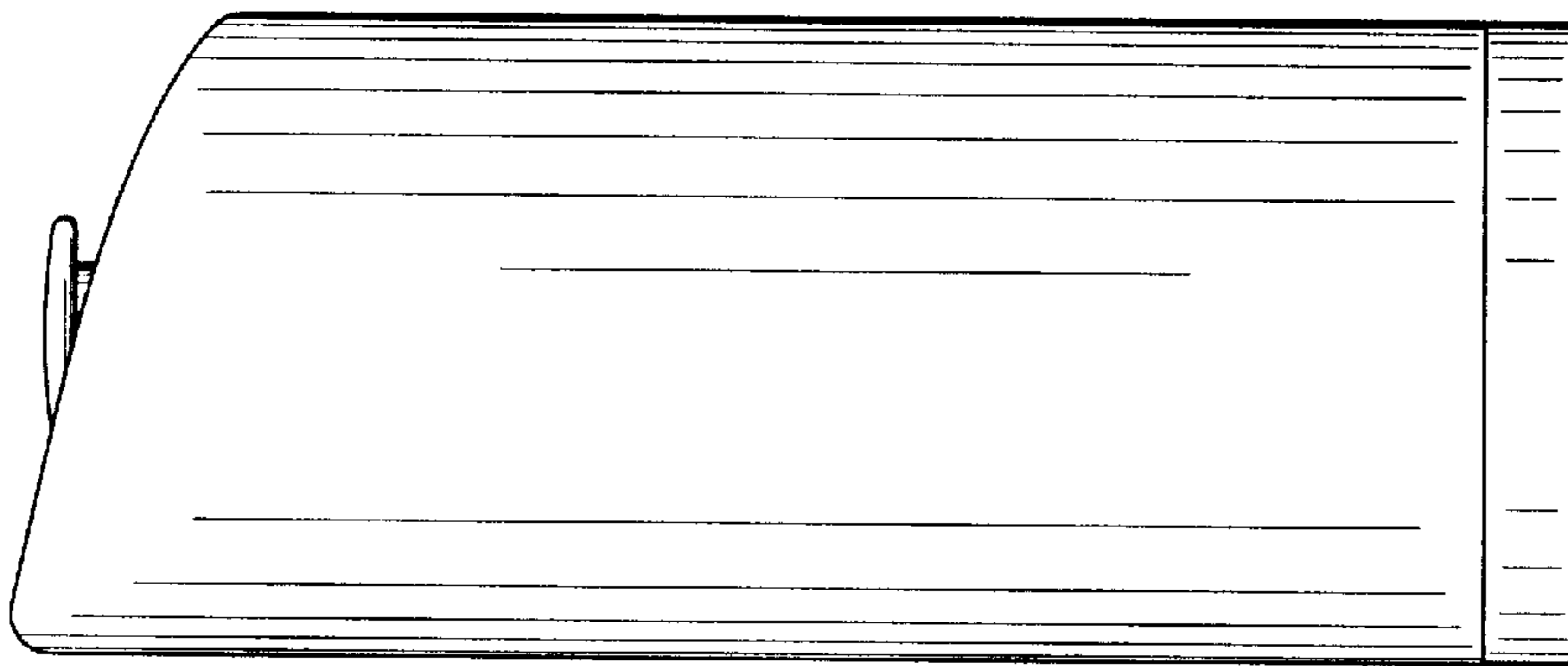


FIG. 5

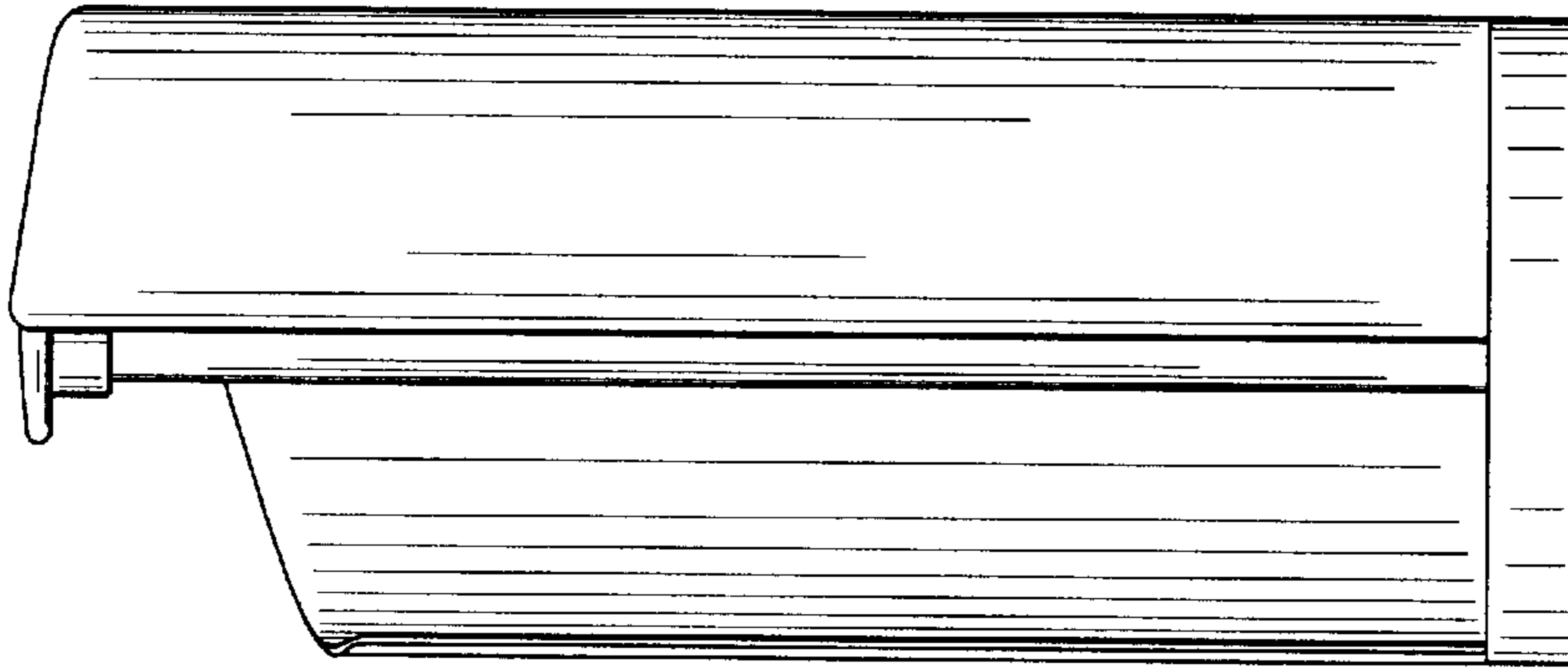


FIG. 6

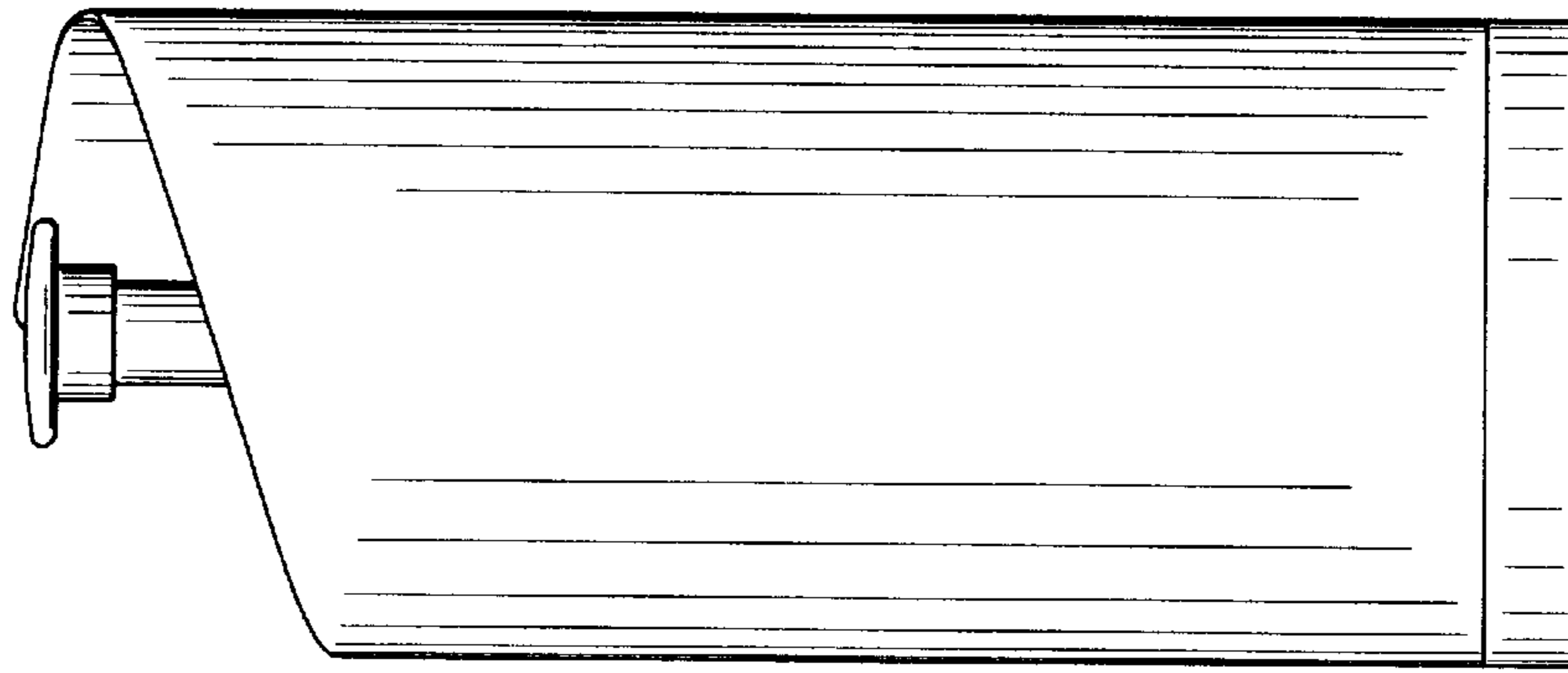


FIG. 7