



US00D404821S

United States Patent [19]

[11] **Patent Number: Des. 404,821**

Azam

[45] **Date of Patent: **Jan. 26, 1999**

[54] **COMBINED BABY NURSER AND THERMOS**

[76] Inventor: **Najmi Sahar Azam**, 3333 Woodland Park Rd., Durham, N.C. 27703

[**] Term: **14 Years**

[21] Appl. No.: **22,229**

[22] Filed: **May 2, 1994**

Related U.S. Application Data

[63] Continuation of Ser. No. 889,755, May 29, 1992, abandoned.

[51] **LOC (6) Cl.** **07-01**

[52] **U.S. Cl.** **D24/197**

[58] **Field of Search** D24/197; 215/11.1, 215/11.2, 11.3, 11.4, 11.5, 11.6; D7/605, 608

[56] References Cited

U.S. PATENT DOCUMENTS

D. 286,911	11/1986	Campbell et al.	D24/197
D. 303,150	8/1989	Falcon	D24/48
D. 310,942	10/1990	Woodall	D7/607
D. 315,212	3/1991	Oknuki	D24/197
D. 321,936	11/1991	Donovan	D24/197

D. 362,306	9/1995	McLean	D24/197
D. 376,431	12/1996	Roach	D24/197
3,658,122	4/1972	Kalyk	165/1
4,502,603	3/1985	Hsu	215/11.6
4,778,068	10/1988	Kohus	215/11.1
4,856,995	8/1989	Wagner	215/11.6 X
4,878,588	11/1989	Ephraim	215/11.2

OTHER PUBLICATIONS

Brochure distributed by American Inventors Corporation approximately during Jul. 1992.

Primary Examiner—Stella Reid

[57] CLAIM

The ornamental design for a combined baby nurser and thermos, as shown and described.

DESCRIPTION

FIG. 1 is a front elevational view of the combined baby nurser and thermos showing my new design; FIG. 2 is a rear elevational view thereof; FIG. 3 is a left side elevational view thereof; FIG. 4 is a right side elevational view thereof; FIG. 5 is a top plan view thereof; FIG. 6 is a bottom plan view thereof; and, FIG. 7 is an exploded isometric view thereof.

1 Claim, 4 Drawing Sheets

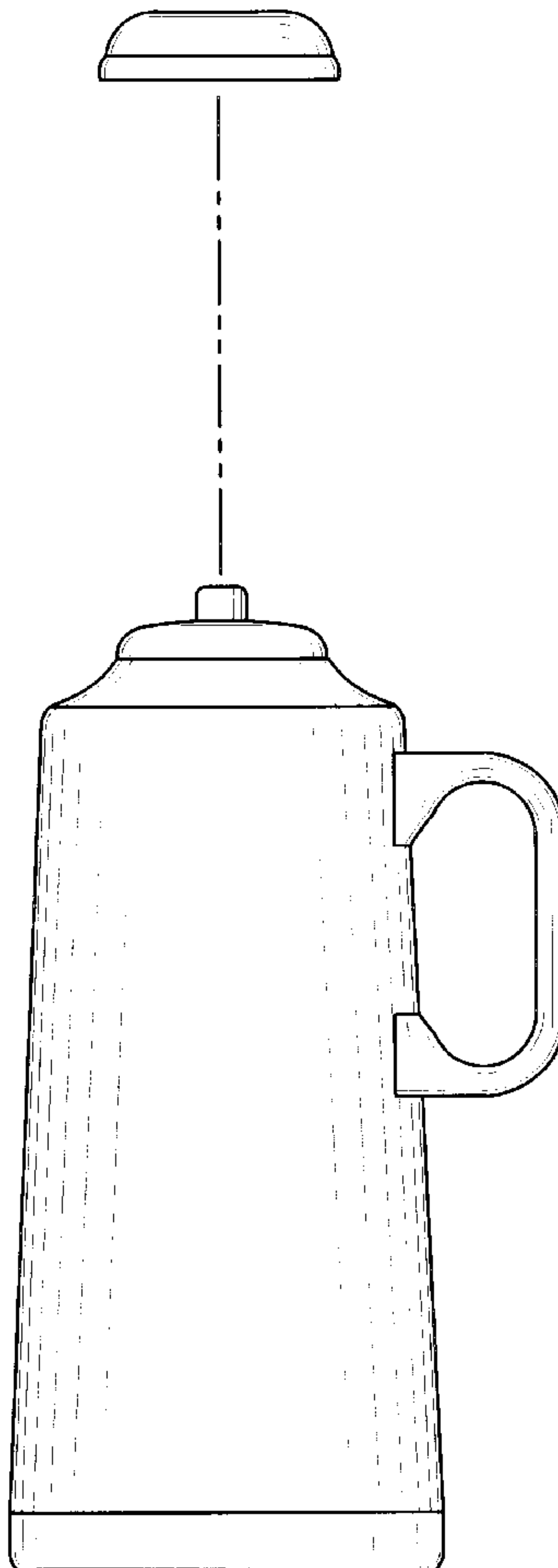

FIG. 1

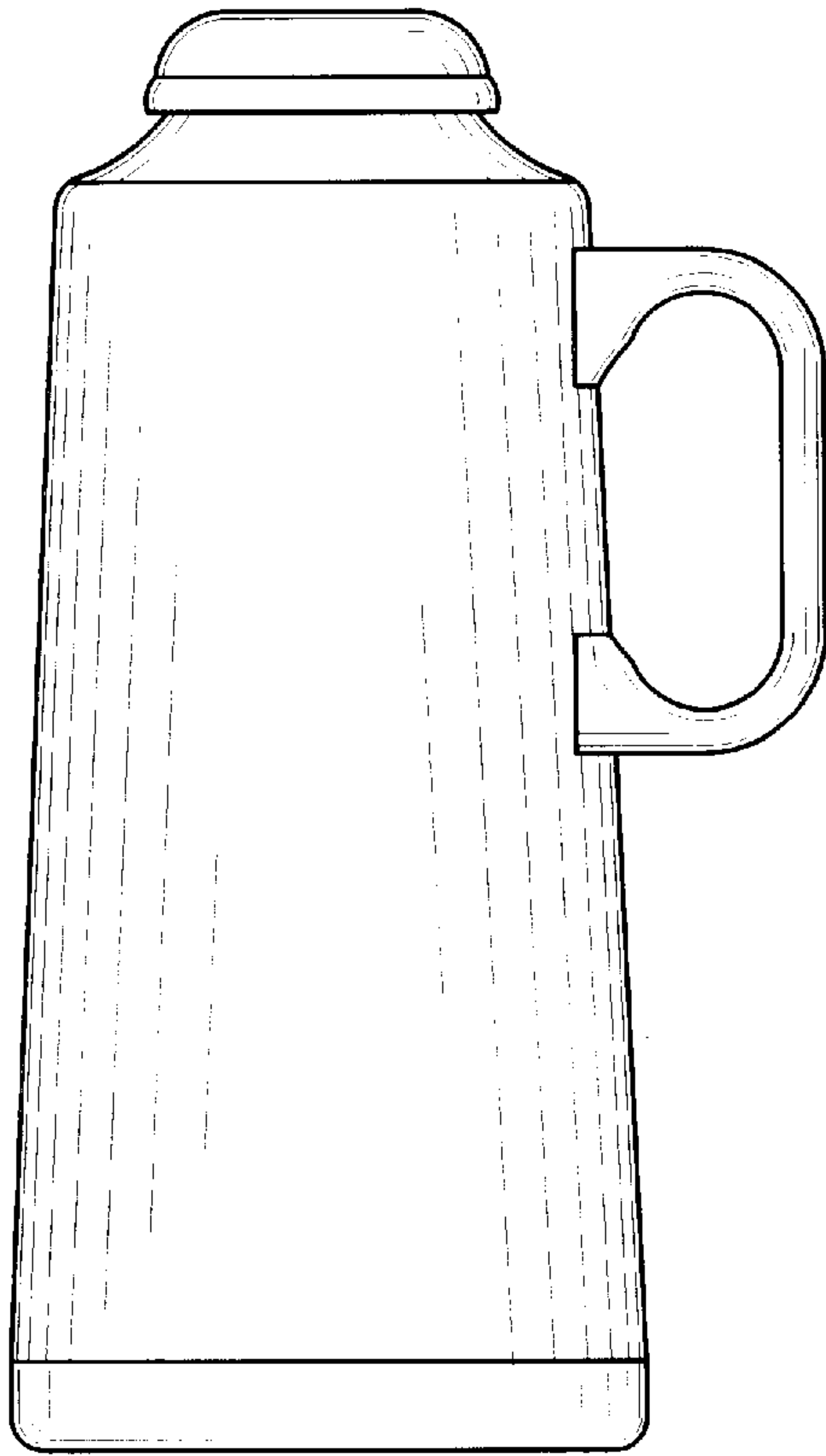

FIG. 2

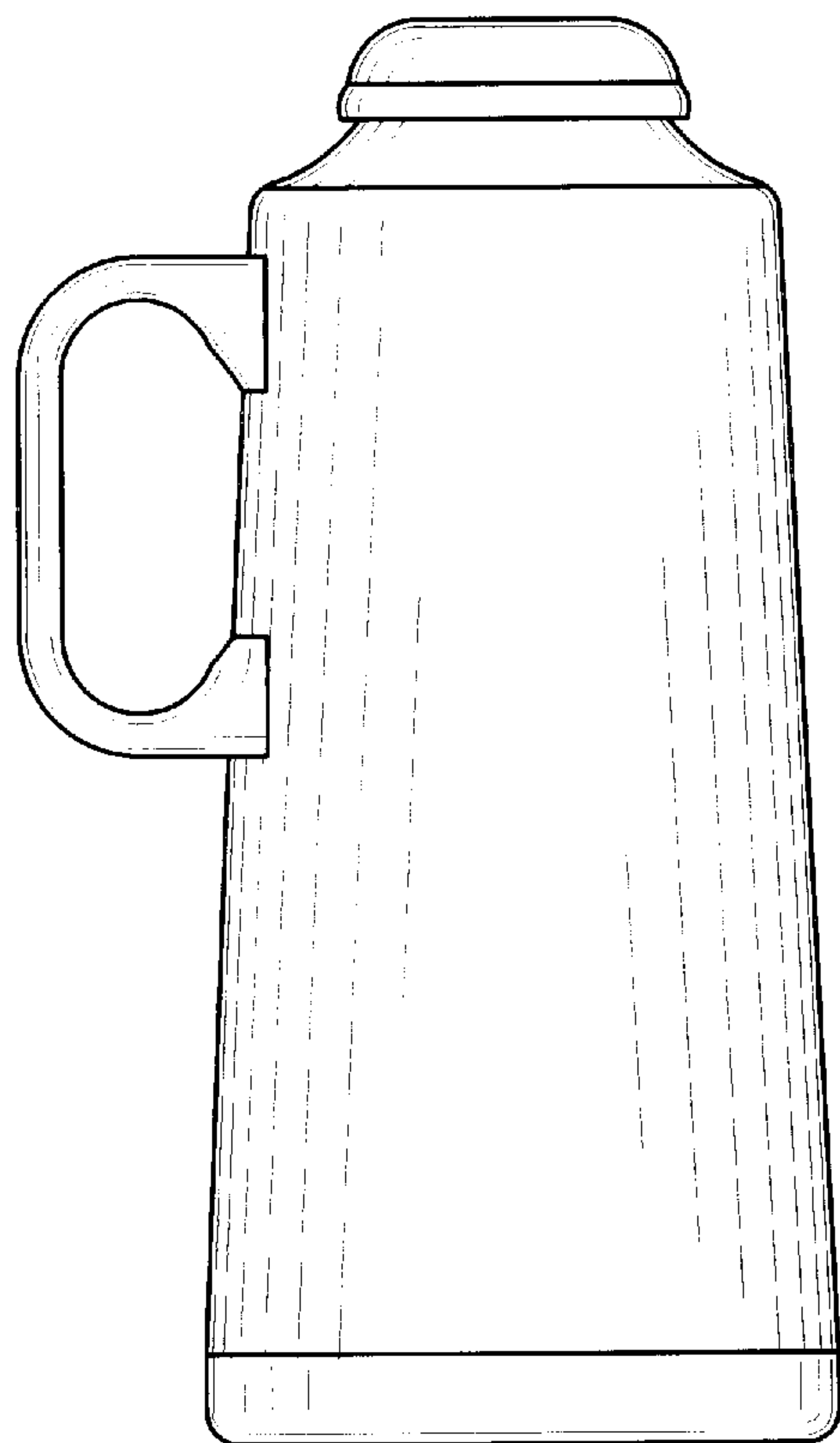

FIG. 3

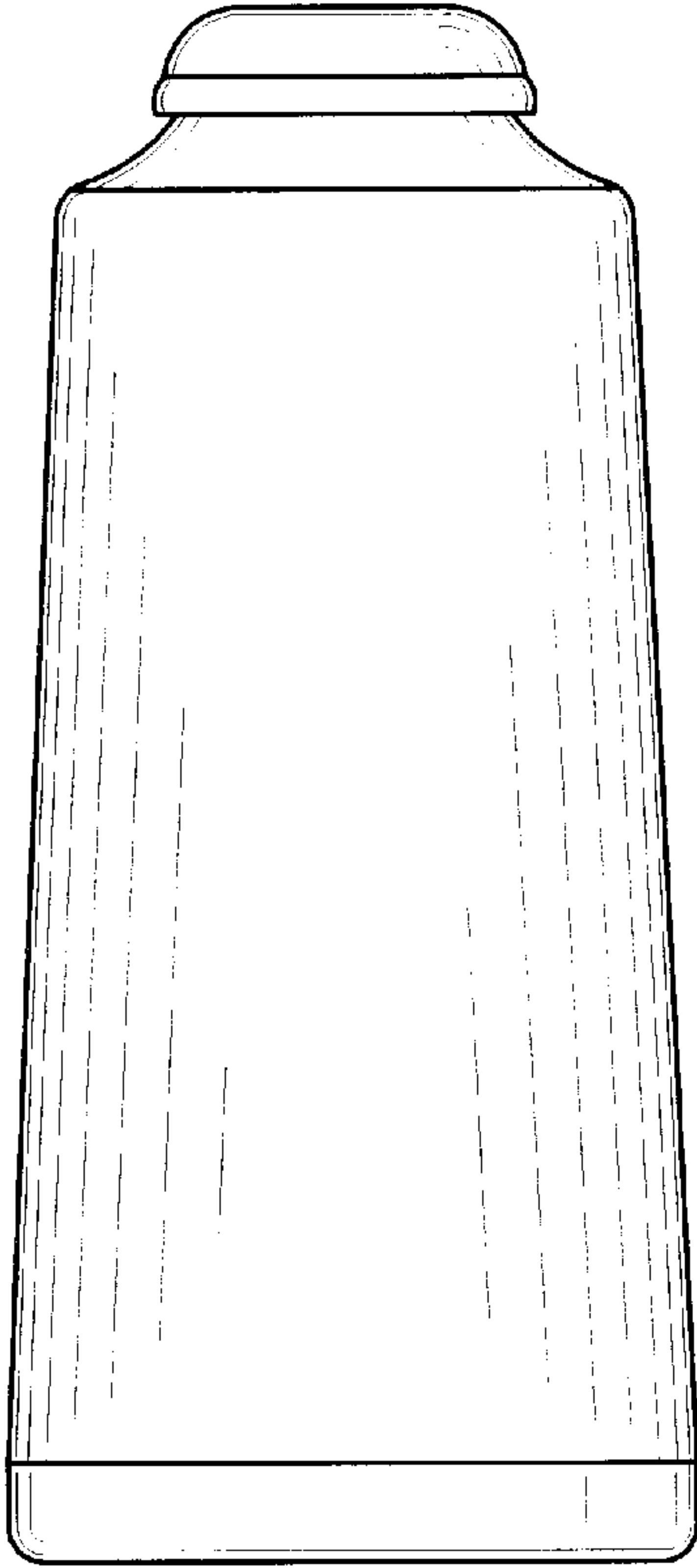

FIG. 4

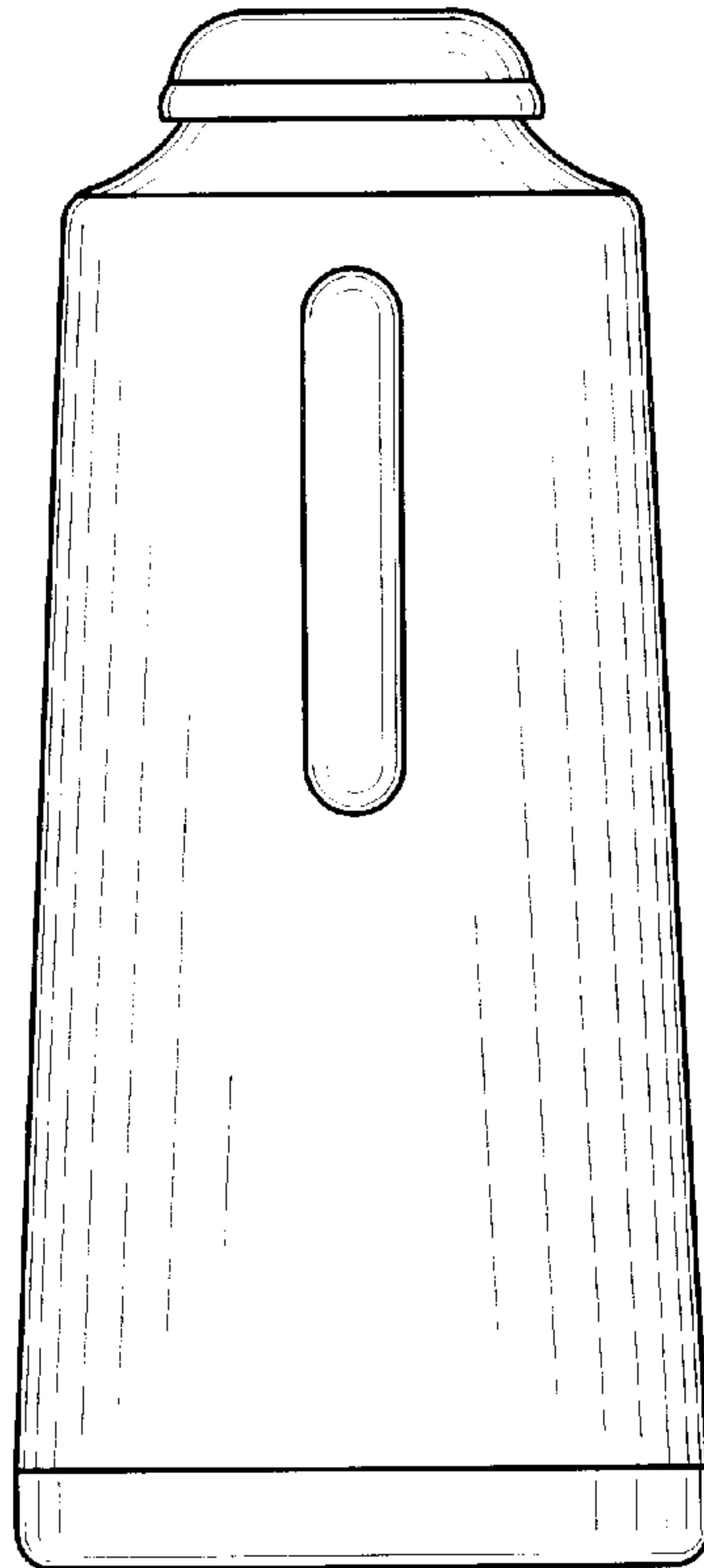

FIG. 5

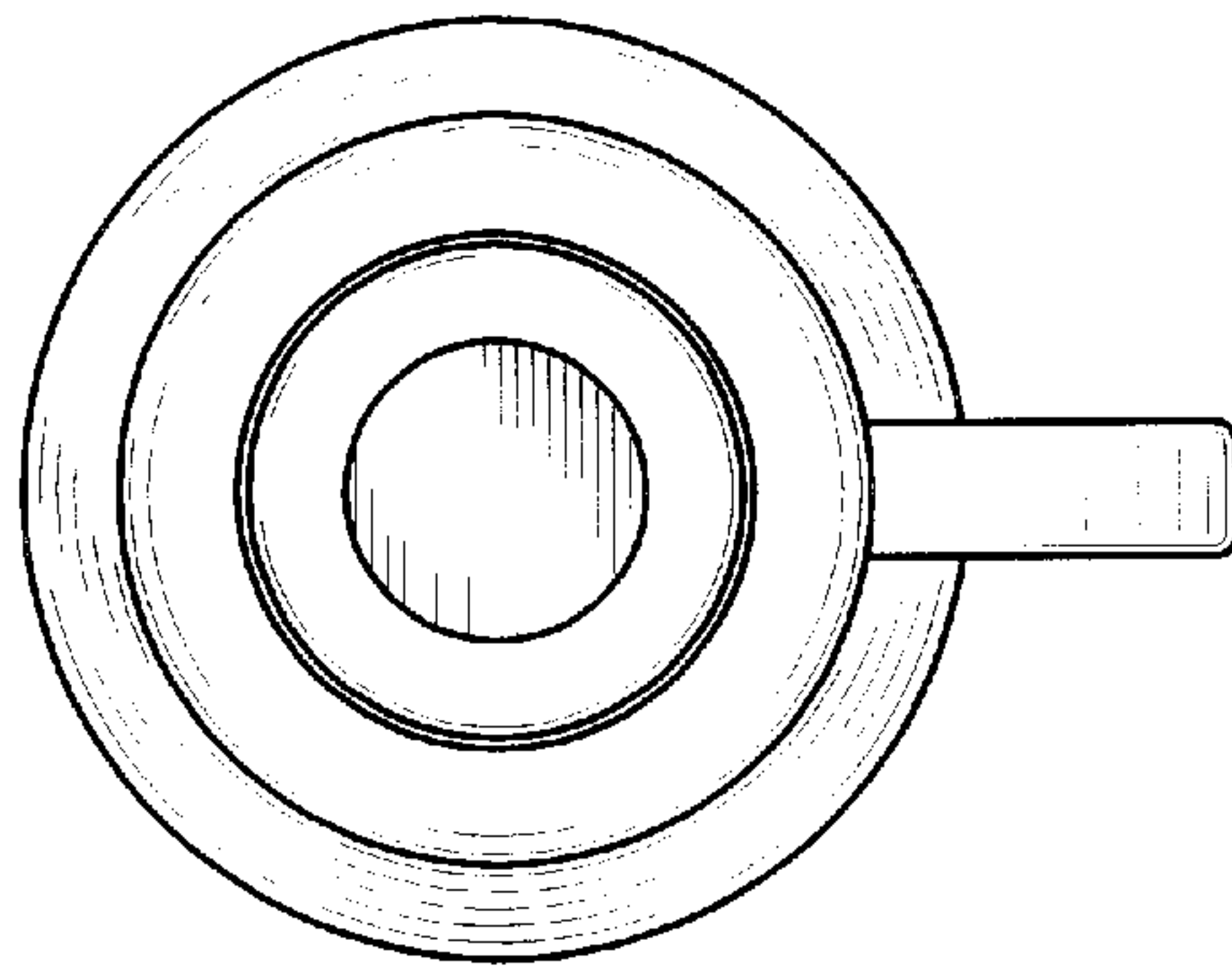
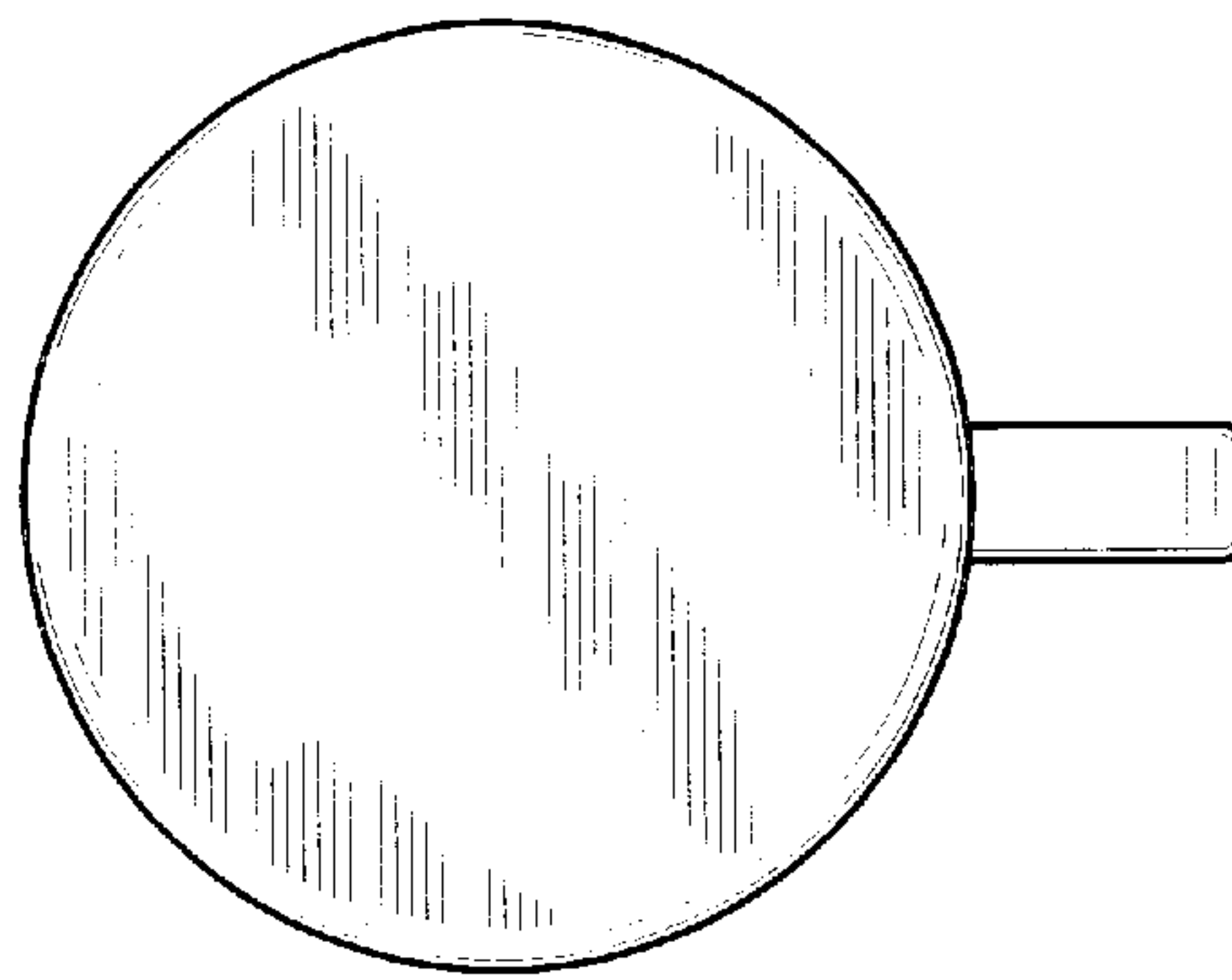

FIG. 6



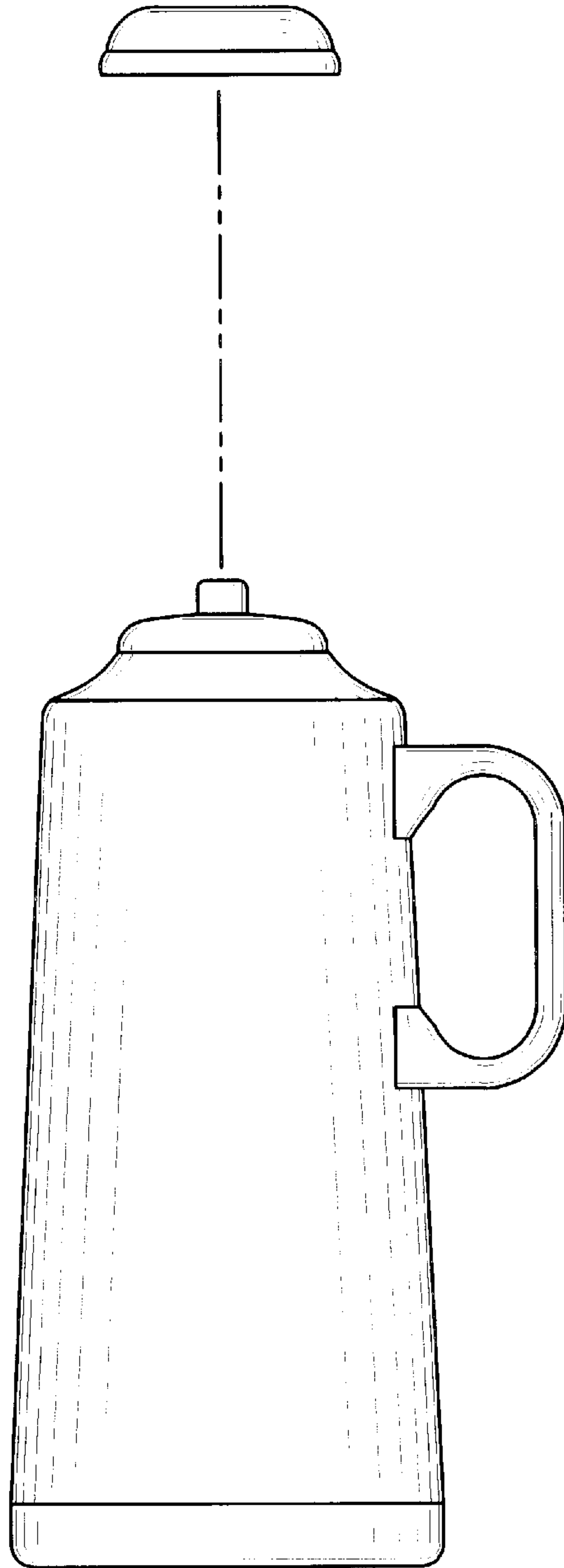

FIG. 7