



US00D404632S

United States Patent [19]

Reynolds et al.

[11] Patent Number: Des. 404,632

[45] Date of Patent: **Jan. 26, 1999

[54] MULTI-USE HANDLE AND TOOL ATTACHMENTS

[75] Inventors: **Mark Franklin Reynolds**, Langley;
Aaron Edward Fader, White Rock;
Burton Leslie Lefebvre, Surrey, all of
Canada

[73] Assignee: **Carica Enterprises, Inc.**, Langley,
Canada

[**] Term: **14 Years**

[21] Appl. No.: **74,900**

[22] Filed: **Aug. 12, 1997**

[51] **LOC (6) Cl.** **08-01**

[52] **U.S. Cl.** **D8/107; D8/105**

[58] **Field of Search** D8/107, 99, 4,
D8/82, 83, 14, 47, 105, 10, 51; D13/183;
D16/135; 7/118, 167; 30/125, 155, 156,
162; 81/440, 427.5

[56] References Cited

U.S. PATENT DOCUMENTS

D. 166,597	4/1952	Filsinger	D16/135
D. 216,286	12/1969	Valeska	D8/107 X
D. 356,475	3/1995	Boylan	D8/51
D. 374,802	10/1996	Spirer et al.	D8/51
D. 378,337	3/1997	Reynolds et al.	..	
D. 379,656	6/1997	Reynolds et al.	..	
1,909,662	5/1933	Connors	D16/135 X
3,384,408	5/1968	Furzey	D8/14 X

OTHER PUBLICATIONS

Ullman Devices Corporation undated catalog—Inspection Mirrors and Telescopic Magnetic Pick-up Tools.

Primary Examiner—Freda Nunn

Attorney, Agent, or Firm—Oyen Wiggs Green & Mutala

[57] CLAIM

The ornamental design for a multi-use handle and tool attachments, as shown and described.

DESCRIPTION

FIG. 1 is a front elevational view of a multi-use handle and

tool attachments with the handle shown separately for clarity of illustration only;

FIG. 2 is a right side elevational view of a multi-use handle without a tool attachment;

FIG. 3 is a back elevational view of a multi-use handle without a tool attachment;

FIG. 4 is a left side elevational view of a multi-use handle without a tool attachment;

FIG. 5 is a top plan view thereof;

FIG. 6 is a bottom plan view thereof;

FIG. 7 is a front elevational view of a magnifying tool attachment shown separately for clarity of illustration only;

FIG. 8 is a right side elevational view of a magnifying tool attachment;

FIG. 9 is a back elevational view of a magnifying tool attachment;

FIG. 10 is a left side elevational view of a magnifying tool attachment;

FIG. 11 is a top plan view thereof;

FIG. 12 is a bottom plan view thereof;

FIG. 13 is a front elevational view of a magnetic tool attachment shown separately for clarity of illustration only the undisclosed rear and side views are a mirror image to the front;

FIG. 14 is a bottom plan view thereof;

FIG. 15 is a top plan view thereof;

FIG. 16 is a front elevational view of another magnetic tool attachment shown separately for clarity of illustration only the undisclosed rear and side views are a mirror image to the front;

FIG. 17 is a bottom plan view thereof;

FIG. 18 is a top plan view thereof; and,

FIG. 19 is a perspective view of the multi-use handle shown in an extended condition with one of the magnetic attachments.

1 Claim, 13 Drawing Sheets

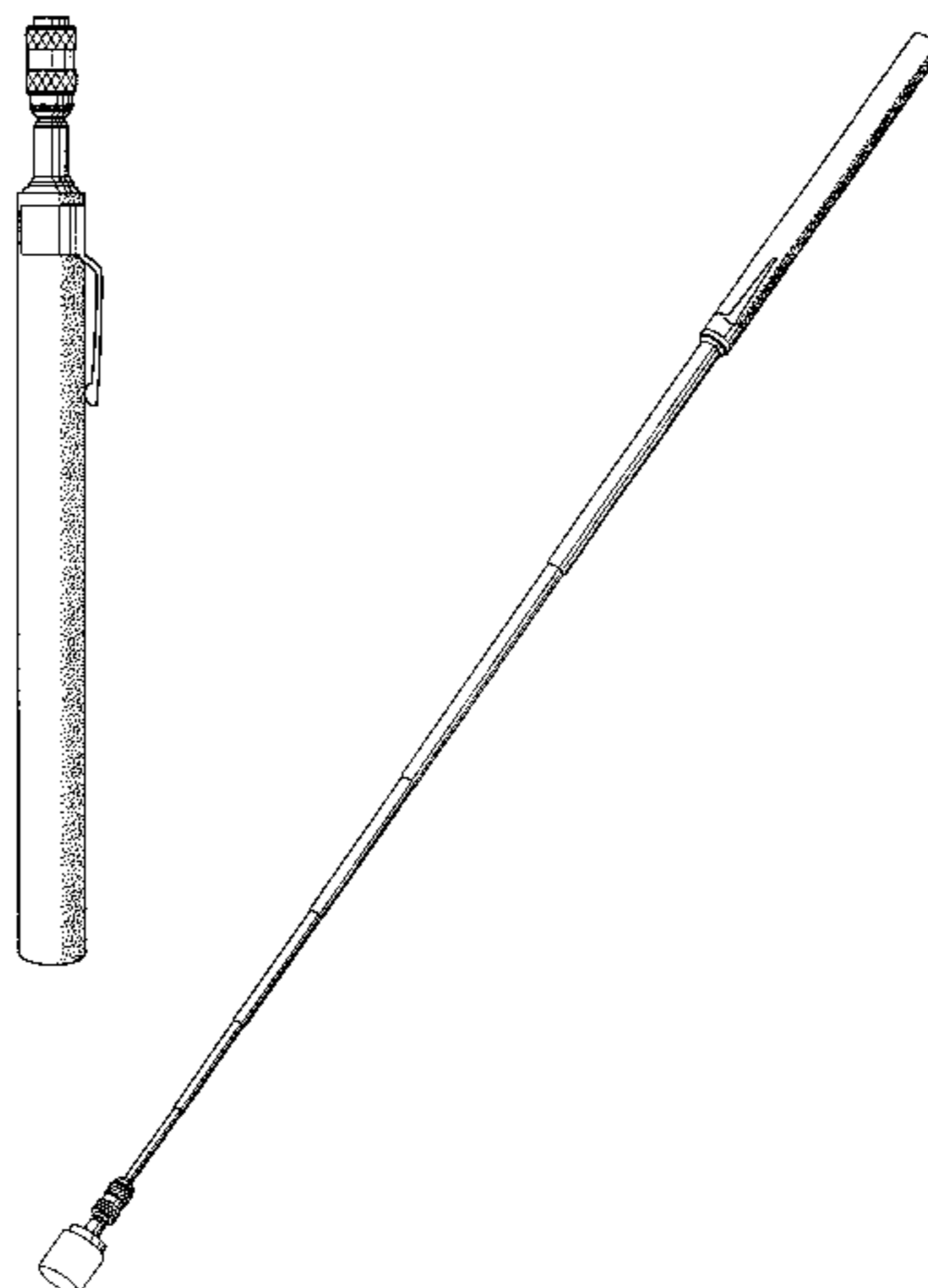

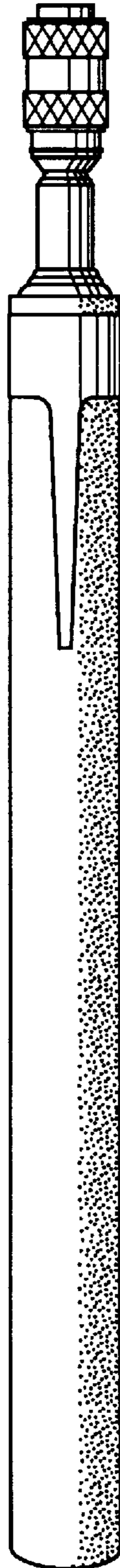

Fig. 1

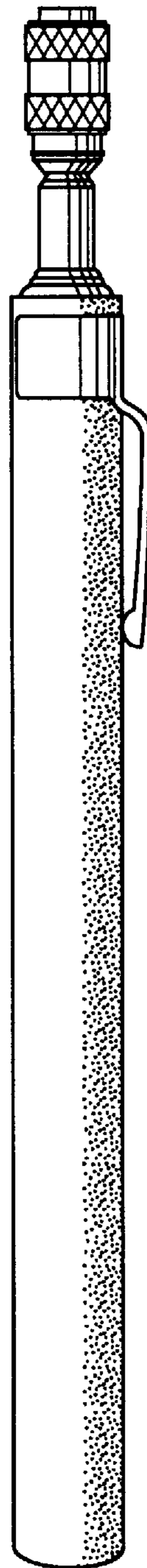

Fig. 2

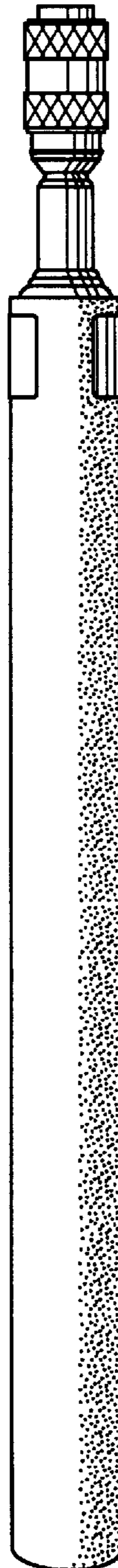

Fig. 3

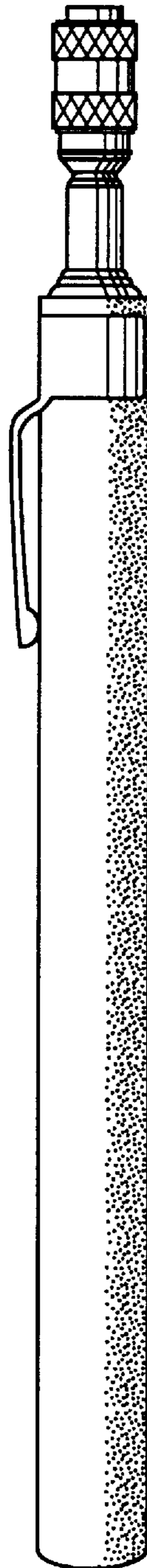

Fig. 4

Fig. 5

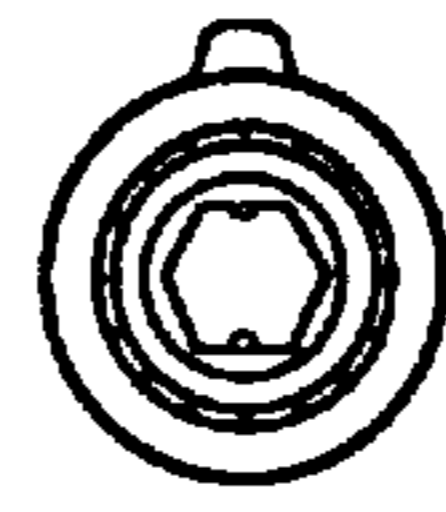

Fig. 6



Fig. 7

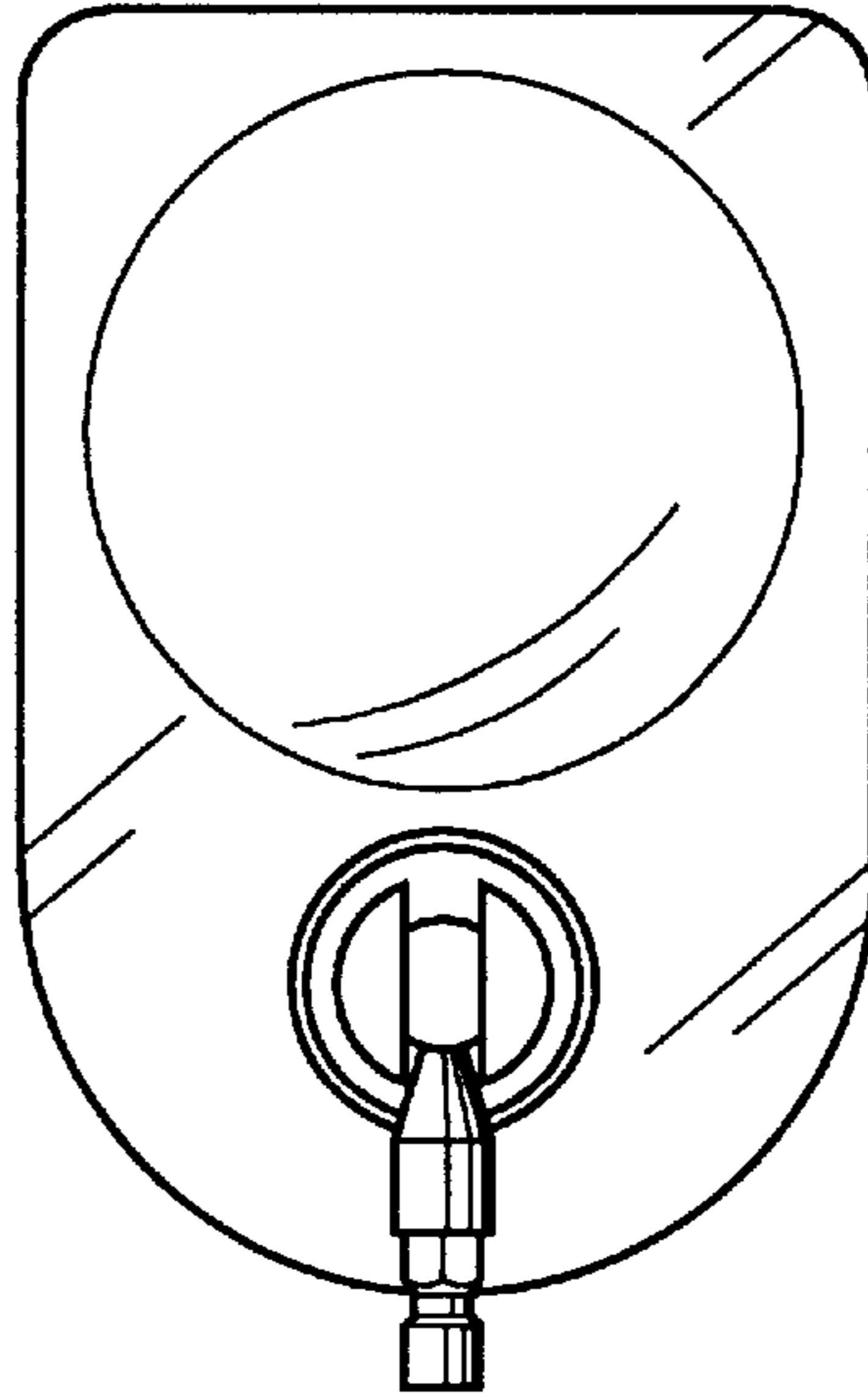

Fig. 8

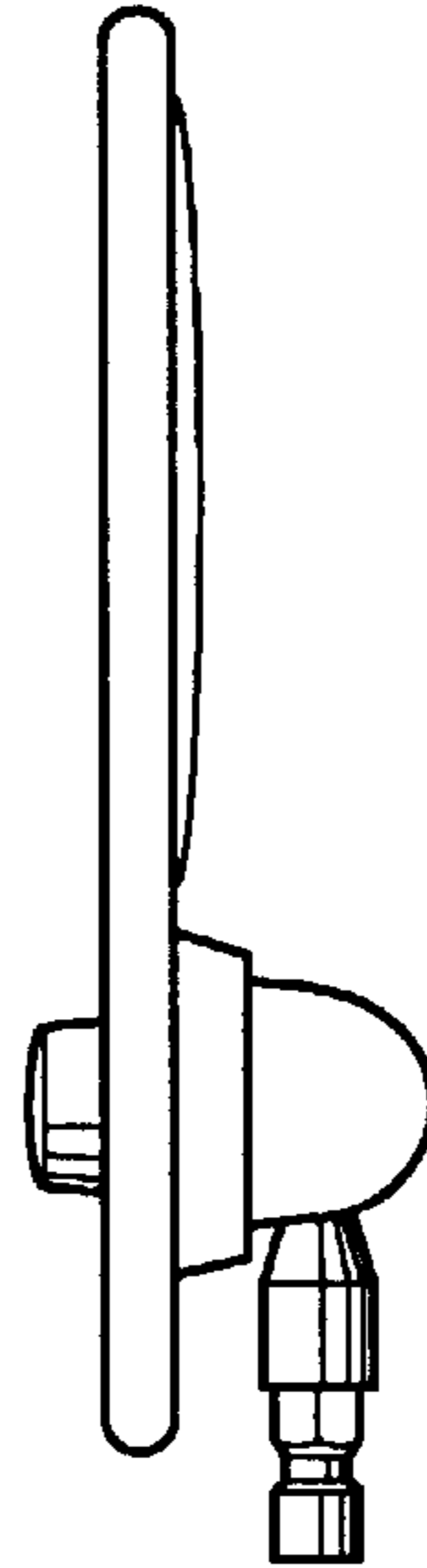

Fig. 9

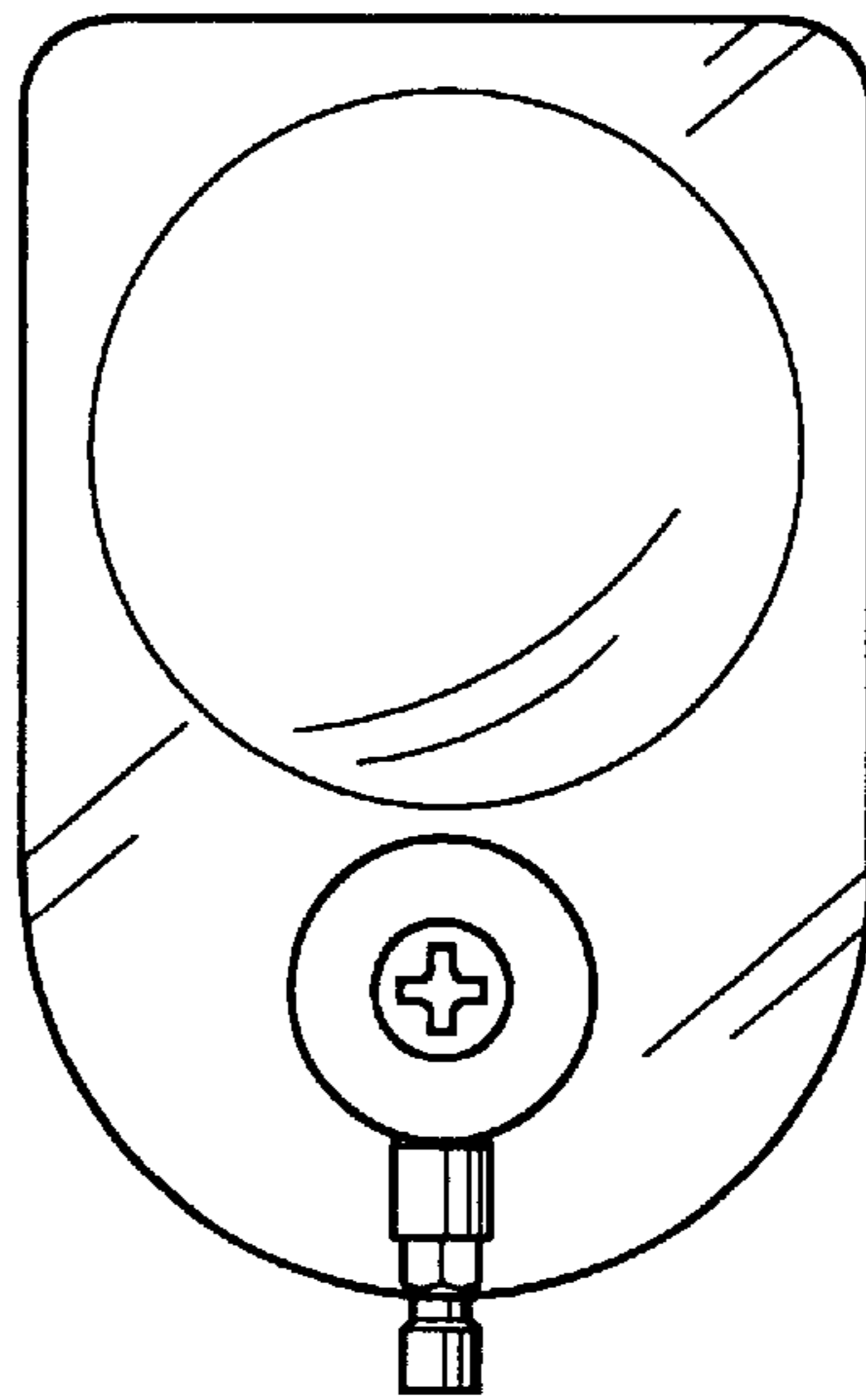

Fig. 10

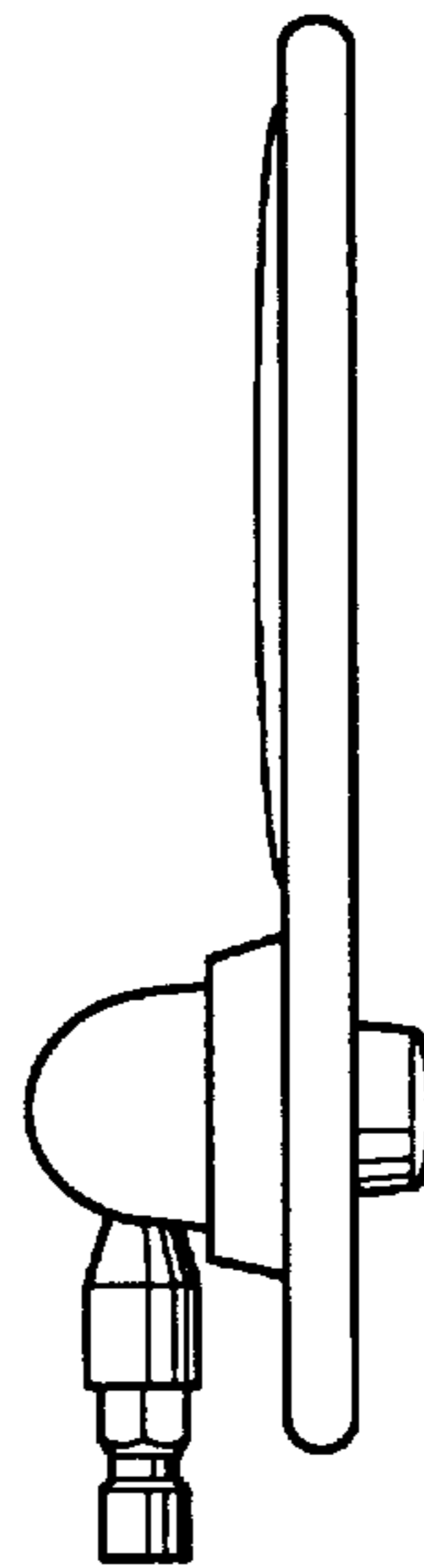

Fig. 11

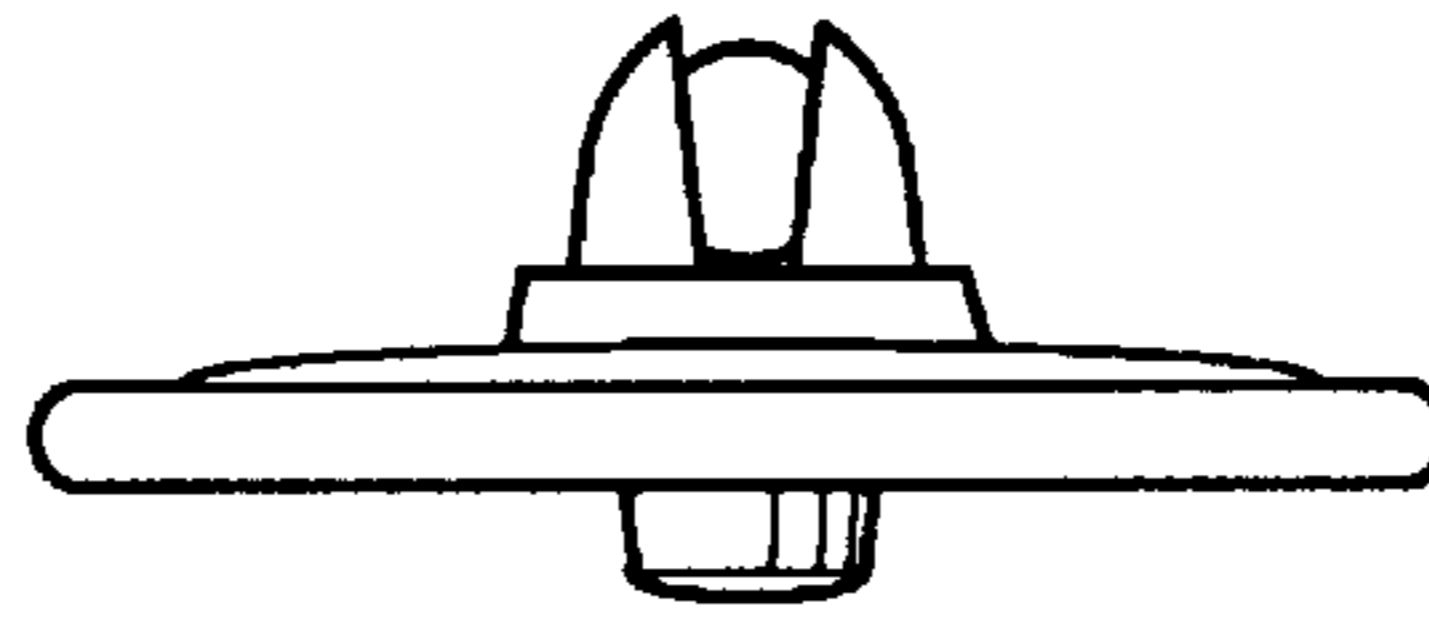

Fig. 12

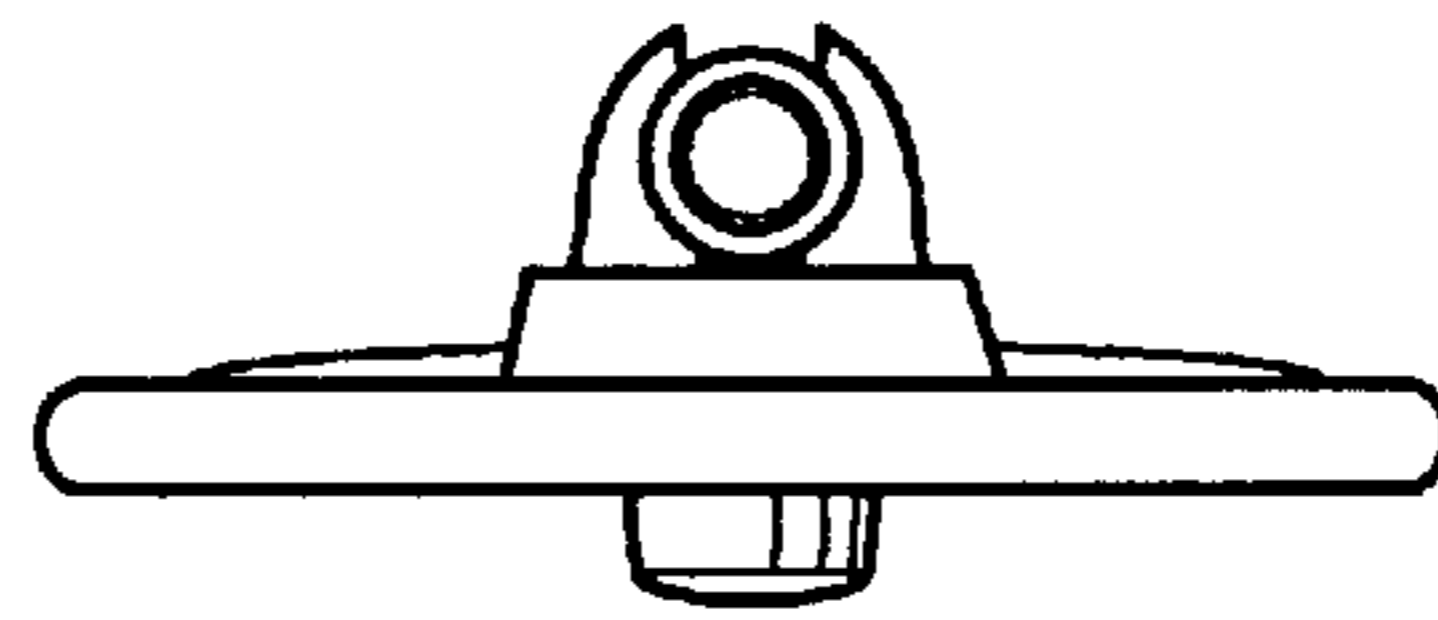

Fig. 13

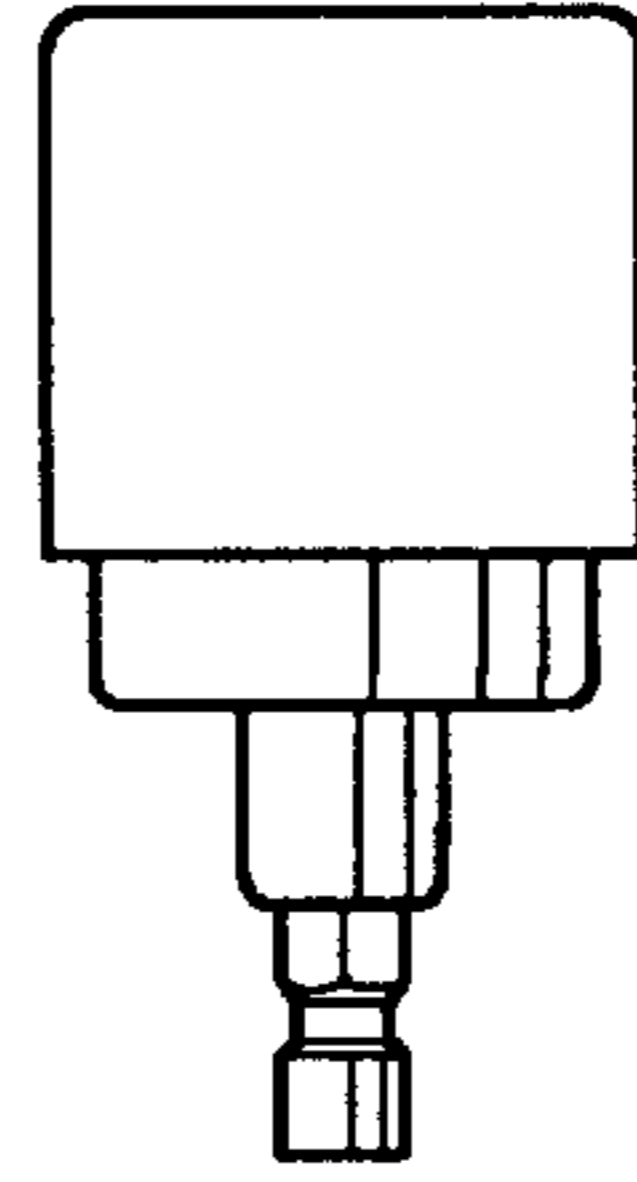

Fig. 14

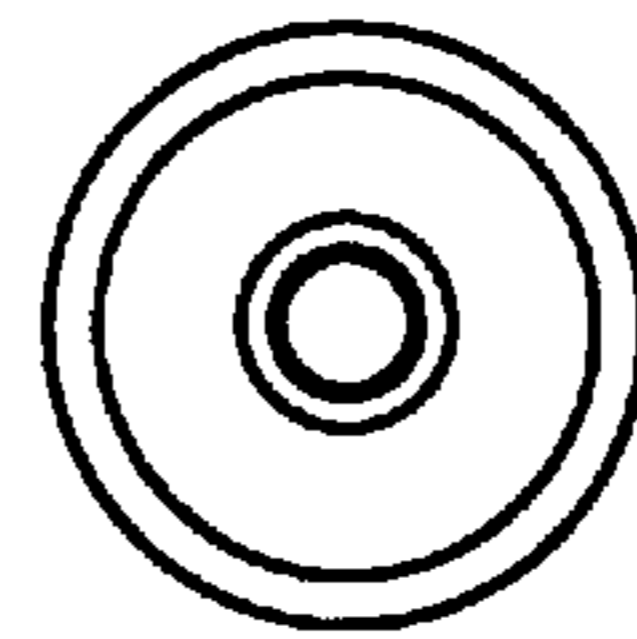

Fig. 15

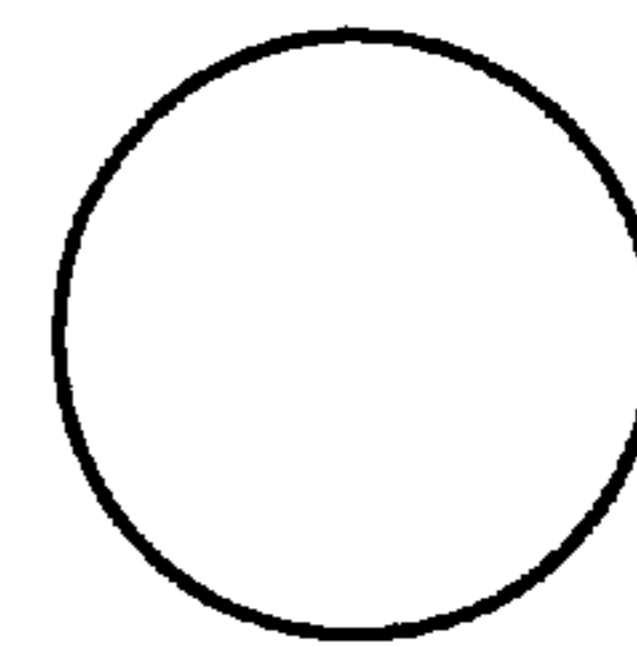

Fig. 16

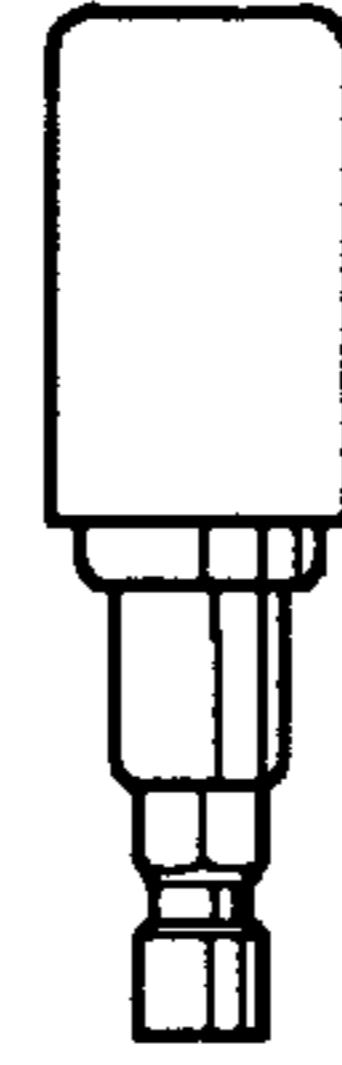

Fig. 17



Fig. 18



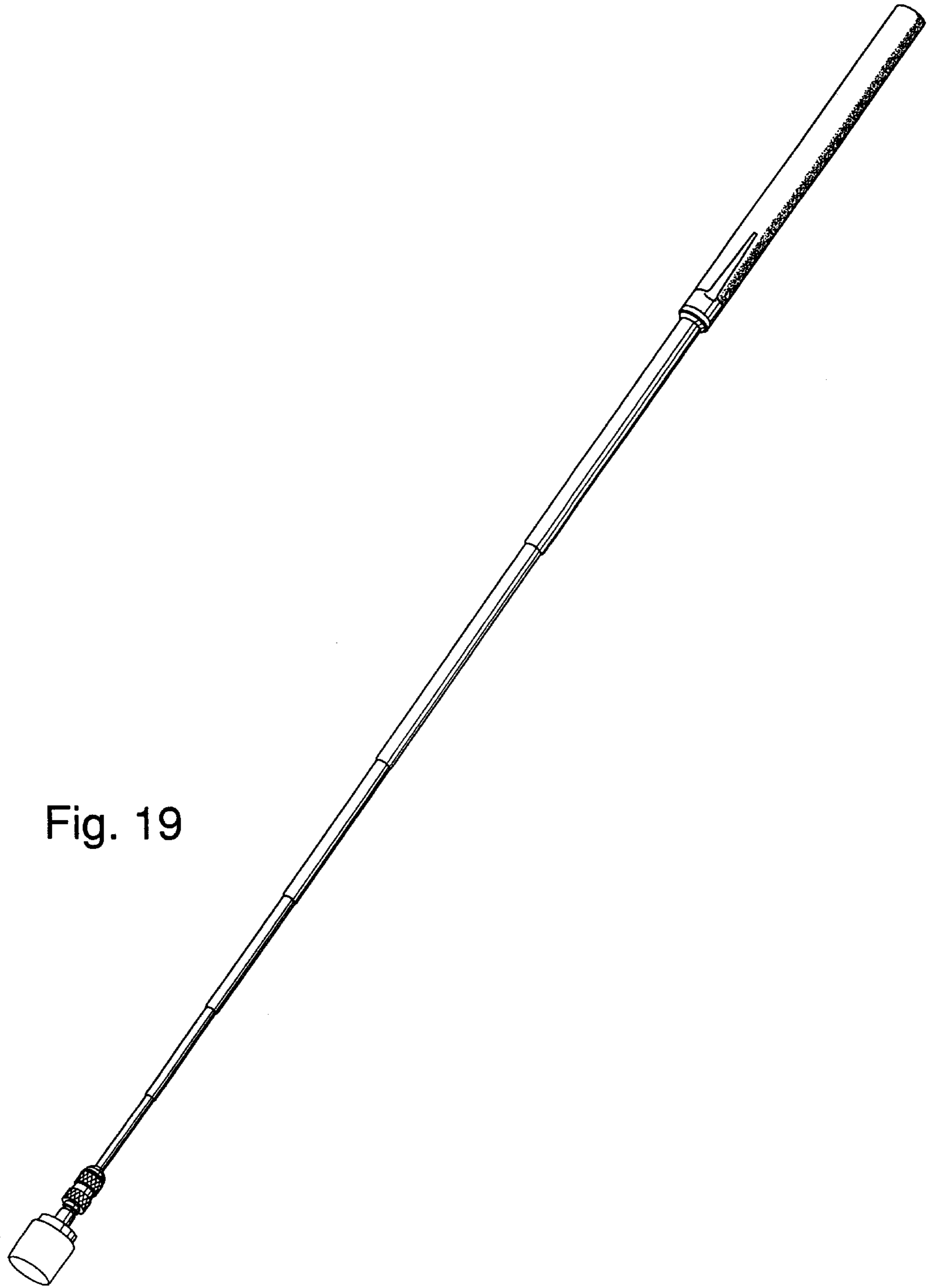

Fig. 19