



US00D404522S

# United States Patent [19] Kip

[11] Patent Number: Des. 404,522

[45] Date of Patent: \*\*Jan. 19, 1999

[54] HAIR VOLUME BRUSH

[75] Inventor: **Albart Johannes Kip**, Groningen, Netherlands

[73] Assignee: **U.S. Philips Corporation**, New York, N.Y.

[\*\*] Term: **14 Years**

[21] Appl. No.: **73,913**

[22] Filed: **Jul. 21, 1997**

[30] **Foreign Application Priority Data**

Feb. 12, 1997 [XH] Hague Agreement ..... DMA/0003 591

[51] **LOC (6) Cl.** ..... **28-03**

[52] **U.S. Cl.** ..... **D28/18; D28/25**

[58] **Field of Search** ..... D28/12-18, 25; 132/271, 272, 112-118; 34/96-98; 392/383-385

[56] **References Cited**

**U.S. PATENT DOCUMENTS**

- D. 247,005 1/1978 Cousins et al. .... D28/18
- D. 277,417 1/1985 Wistrand ..... D28/13

- D. 349,585 8/1994 Rizzuto et al. .... D28/18
- D. 381,766 7/1997 Smal ..... D28/18
- D. 383,874 9/1997 Rizzuto ..... D28/18
- D. 388,538 12/1997 Kip ..... D28/18
- D. 392,413 3/1998 Gudefin ..... D28/18
- 5,546,674 8/1996 Lange et al. .... 34/97

**FOREIGN PATENT DOCUMENTS**

- 3234014 3/1984 Germany ..... 34/96

*Primary Examiner*—Ted Shooman

*Assistant Examiner*—C. Tuttle

*Attorney, Agent, or Firm*—Ernestine C. Bartlett

[57] **CLAIM**

The ornamental design for a hair volume brush, as shown.

**DESCRIPTION**

FIG. 1 is a perspective view showing my design;  
 FIG. 2 is a front elevational view thereof;  
 FIG. 3 is a rear elevational view thereof;  
 FIG. 4 is a right side elevational view thereof;  
 FIG. 5 is a left side elevational view thereof;  
 FIG. 6 is a top plan view thereof; and,  
 FIG. 7 is a bottom plan view thereof.

**1 Claim, 5 Drawing Sheets**

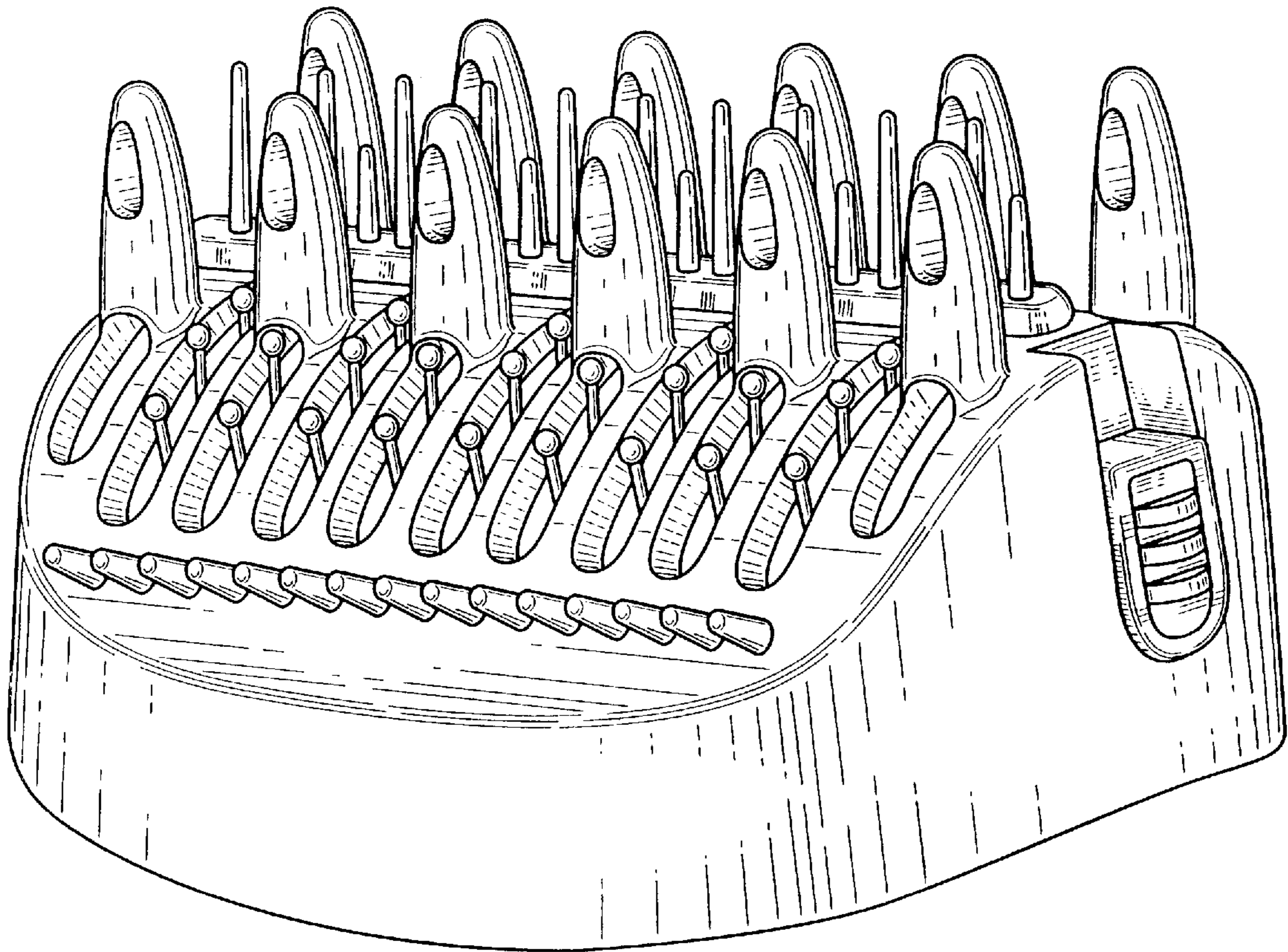

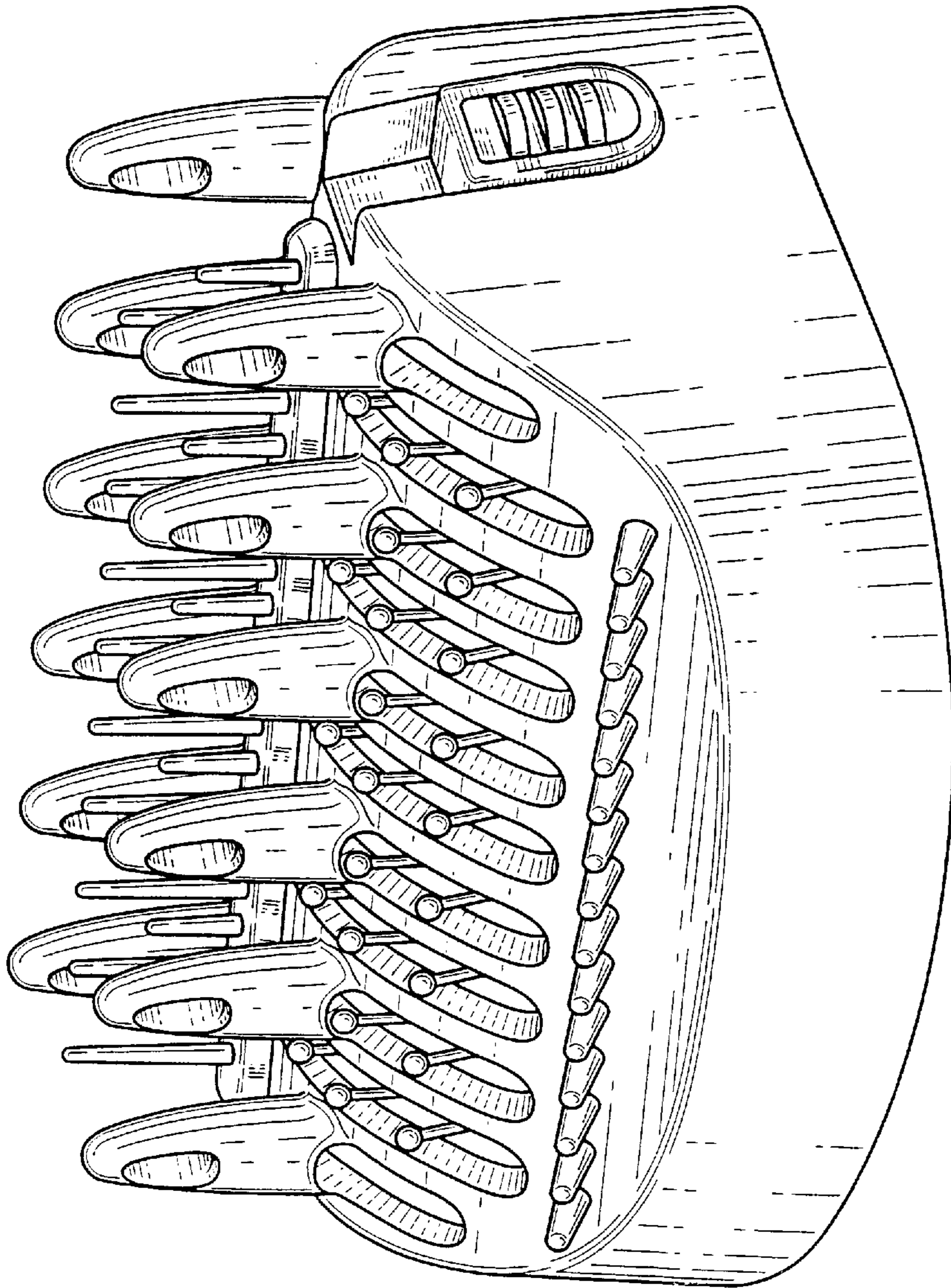

FIG. 1

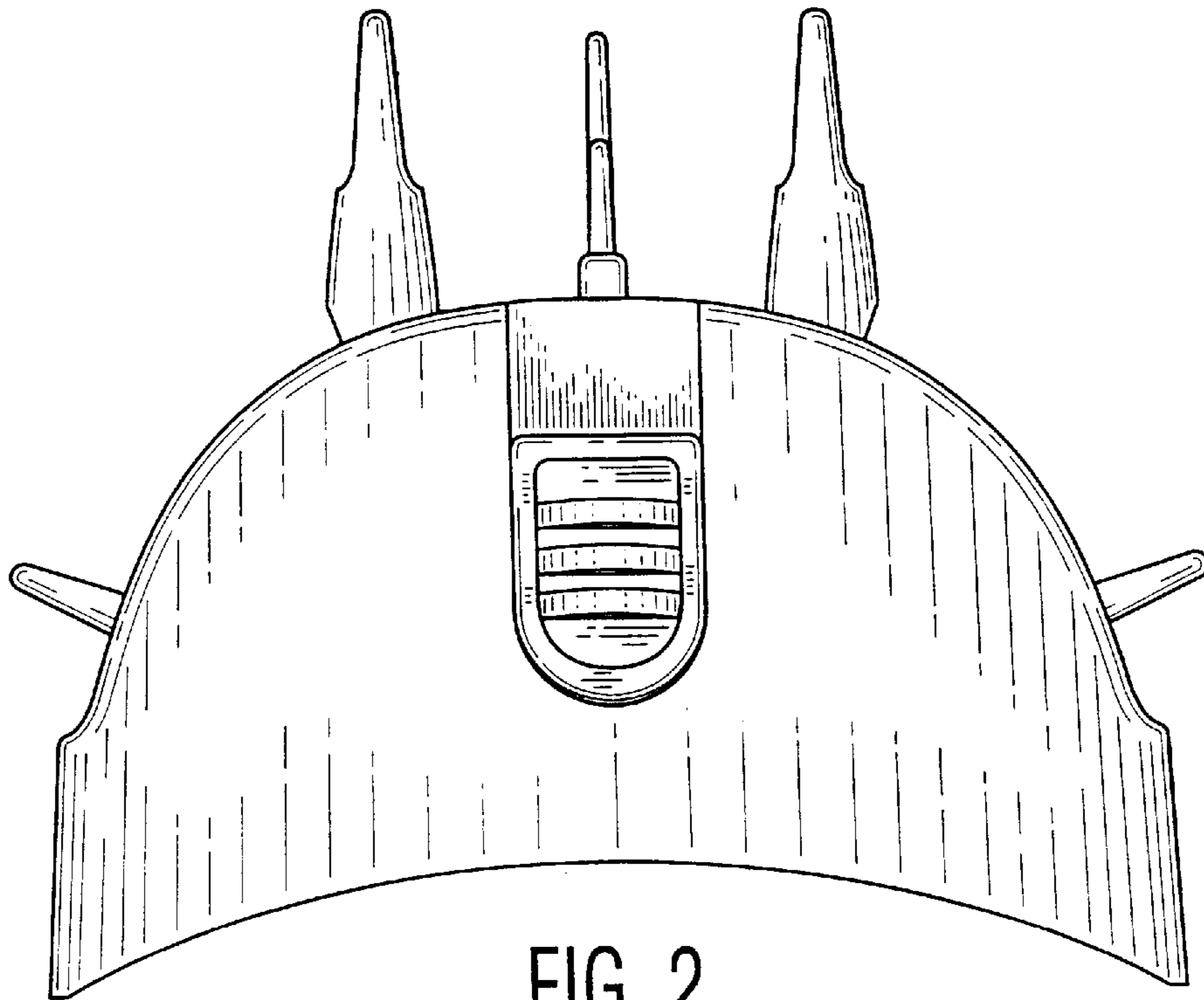

FIG. 2

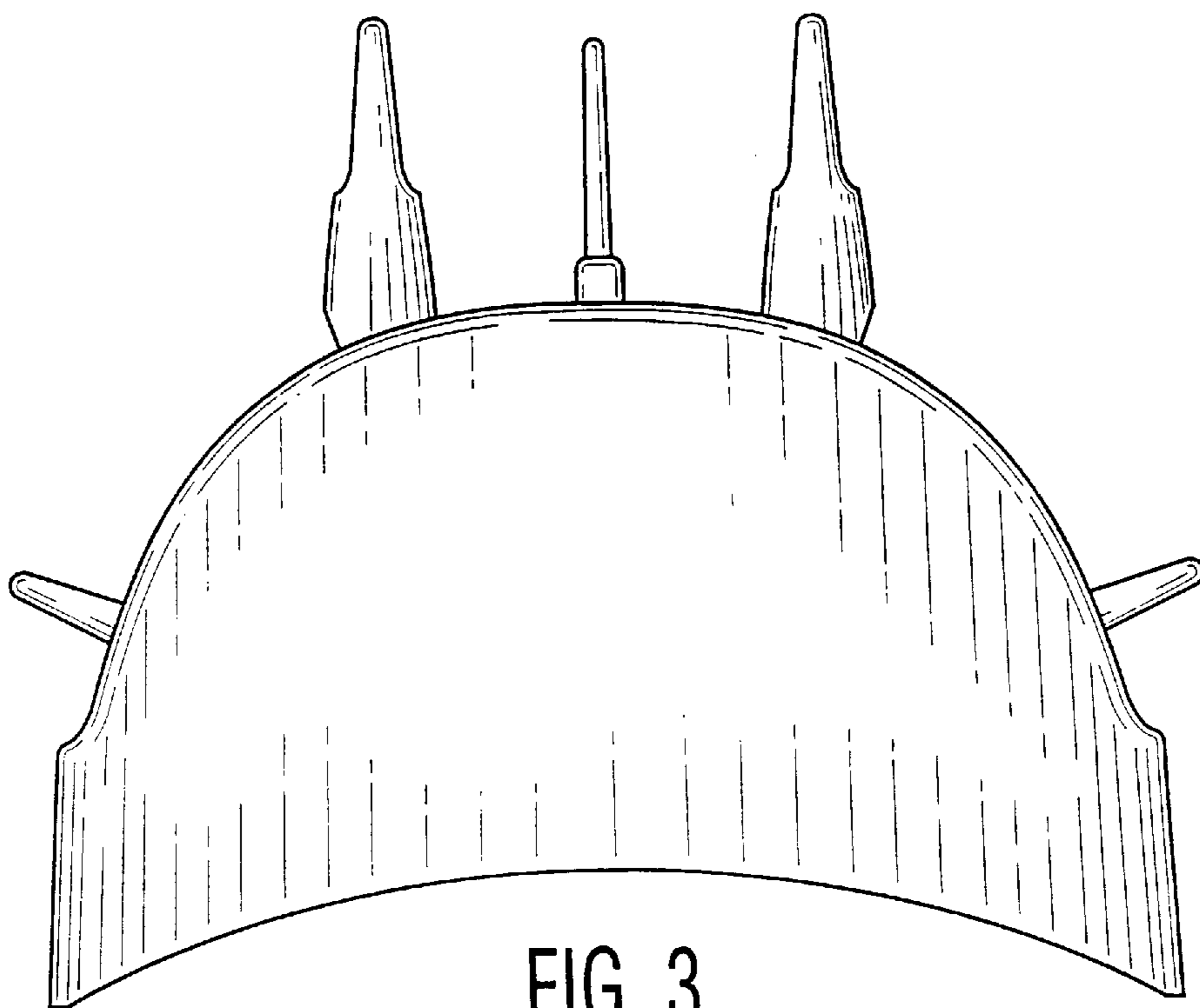

FIG. 3



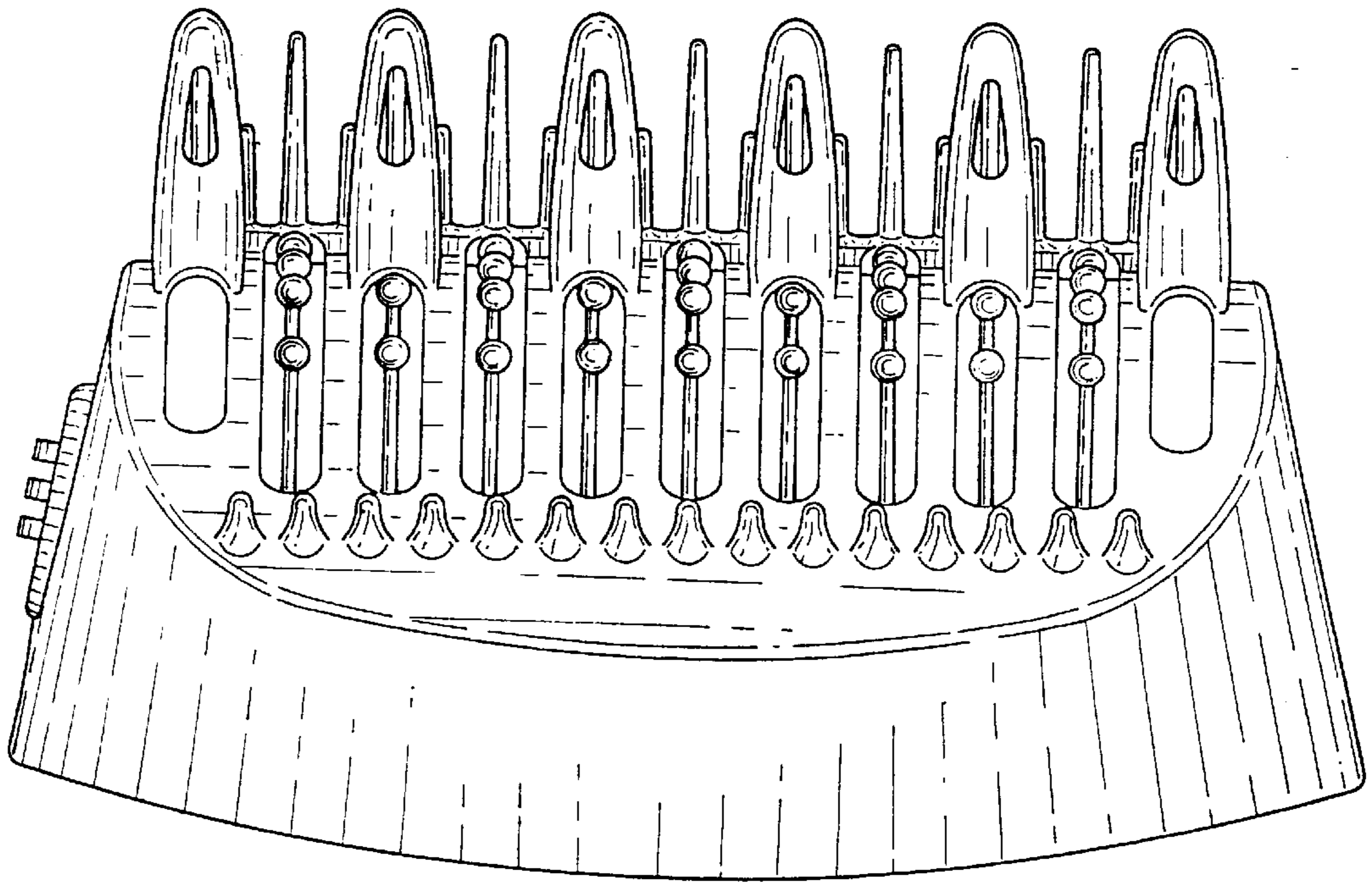

FIG. 4

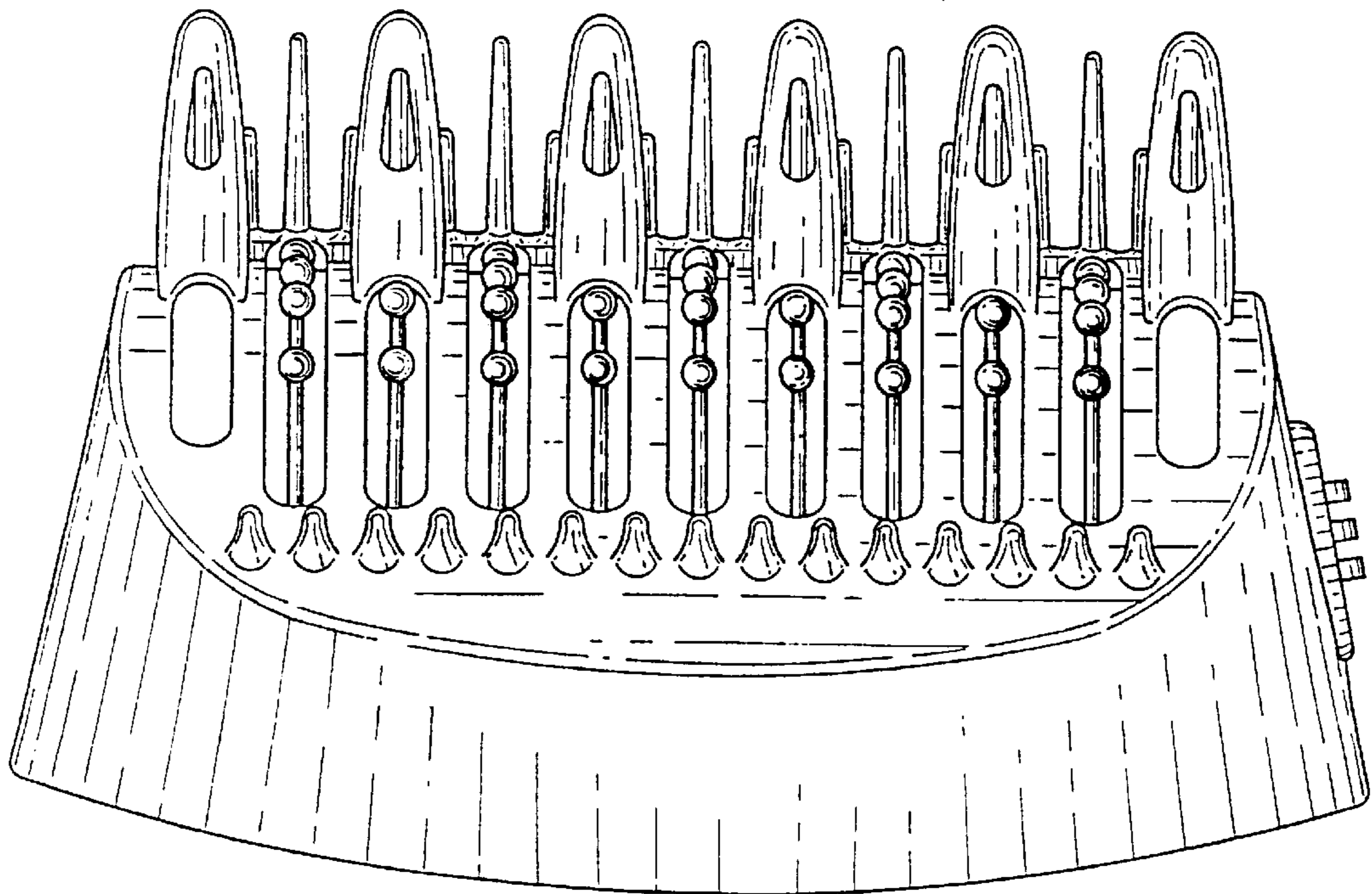

FIG. 5

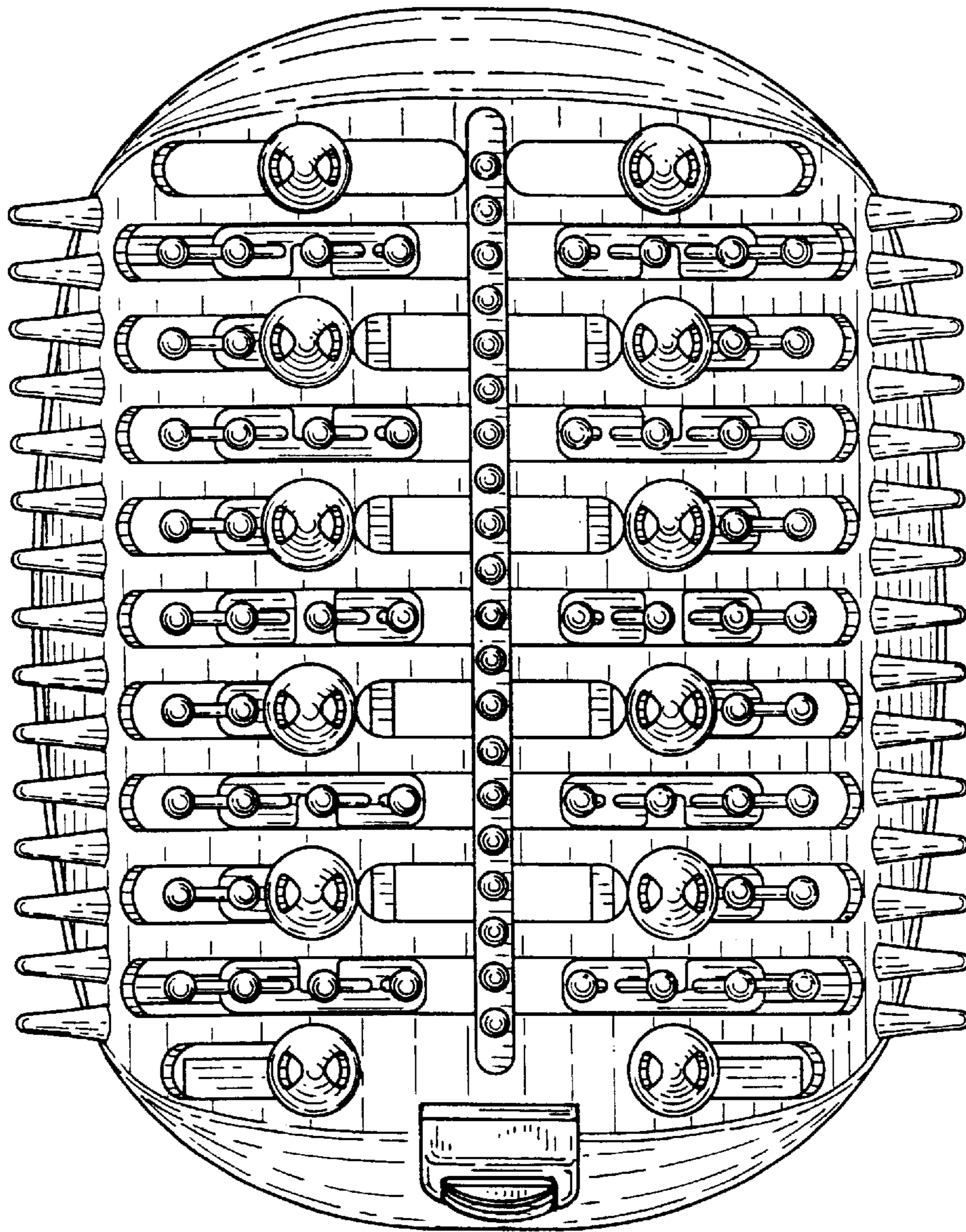

FIG. 6

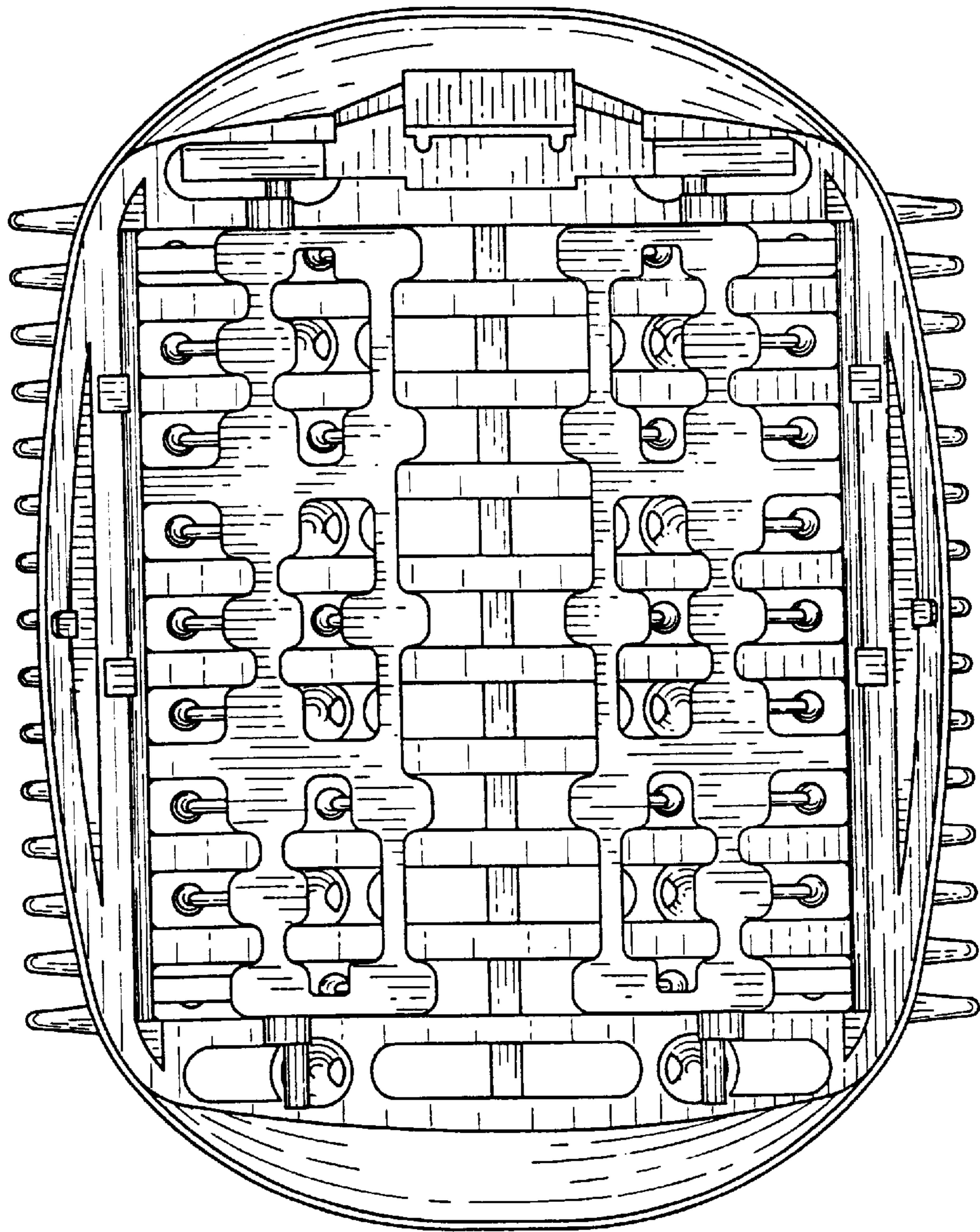

FIG. 7