



US00D404520S

United States Patent [19] Kim

[11] Patent Number: Des. 404,520

[45] Date of Patent: **Jan. 19, 1999

[54] **COMBINATION LIGHTER AND CIGAR CUTTER**

[75] Inventor: **Hyun Ki Kim**, Incheon, Rep. of Korea

[73] Assignee: **East-West Trading Co.**, Chicago, Ill.

[**] Term: **14 Years**

[21] Appl. No.: **85,353**

[22] Filed: **Mar. 20, 1998**

[51] **LOC (6) Cl.** **27-05**

[52] **U.S. Cl.** **D27/143; D27/142**

[58] **Field of Search** D27/139, 140, D27/141, 142, 143, 144, 145, 146, 147, 148, 149, 150, 151, 152, 153, 154, 155, 156, 157, 158, 159, 160, 161; 431/253, 256, 254, 127, 128, 142, 143; 131/249

[56] **References Cited**

U.S. PATENT DOCUMENTS

306,672	10/1884	Brown .	
D. 377,845	2/1997	Maruyama D27/142
D. 387,474	12/1997	Fontaine, Jr. D27/143
1,068,300	7/1913	Baumbach .	
1,502,974	7/1924	Aronson .	
2,499,752	3/1950	Hrabal .	
4,600,022	7/1986	Pierce, Jr. .	

Primary Examiner—Susan J. Lucas
Assistant Examiner—Jennifer Rivard
Attorney, Agent, or Firm—Trexler, Bushnell, Giangiorgi & Blackstone, Ltd.

[57] **CLAIM**

I claim the ornamental design for a combination lighter and cigar cutter, as shown and described.

DESCRIPTION

FIG. 1 is a perspective view of the present invention; FIG. 2 is a front elevational view of the present invention; FIG. 3 is a left side elevational view of the present invention; FIG. 4 is a rear elevational view of the present invention; FIG. 5 is a right side elevational view of the present invention; FIG. 6 is a top view of the present invention; FIG. 7 is a bottom view of the present invention; FIG. 8 is a perspective view of the present invention in its cigar cutting mode; FIG. 9 is a front elevational view of the present invention in its cigar cutting mode; FIG. 10 is a top view of the present invention in its cigar cutting mode; FIG. 11 is a bottom view of the present invention in its cigar cutting mode; FIG. 12 is a left side elevational view of the present invention in its cigar cutting mode; FIG. 13 is a rear elevational view of the present invention in its cigar cutting mode; and, FIG. 14 is a right side elevational view of the present invention in its cigar cutting mode. The broken lines are shown for illustrative purposes only and form no part of the claimed design.

1 Claim, 4 Drawing Sheets

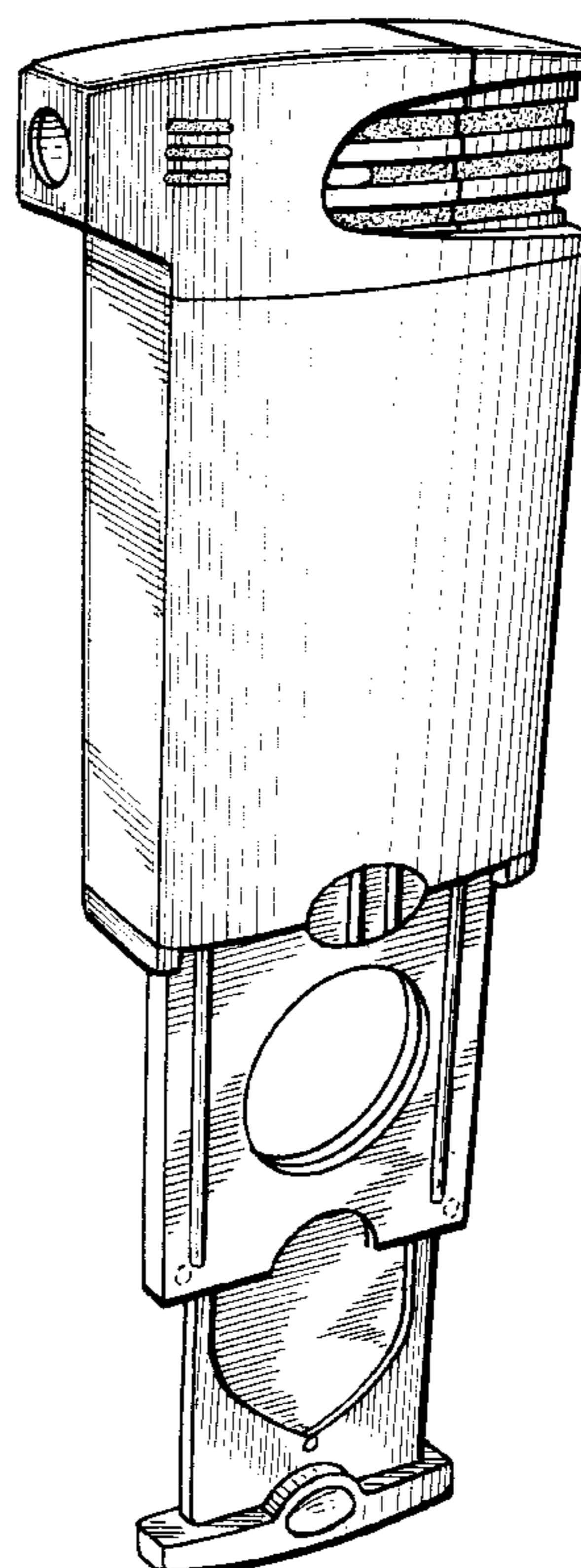
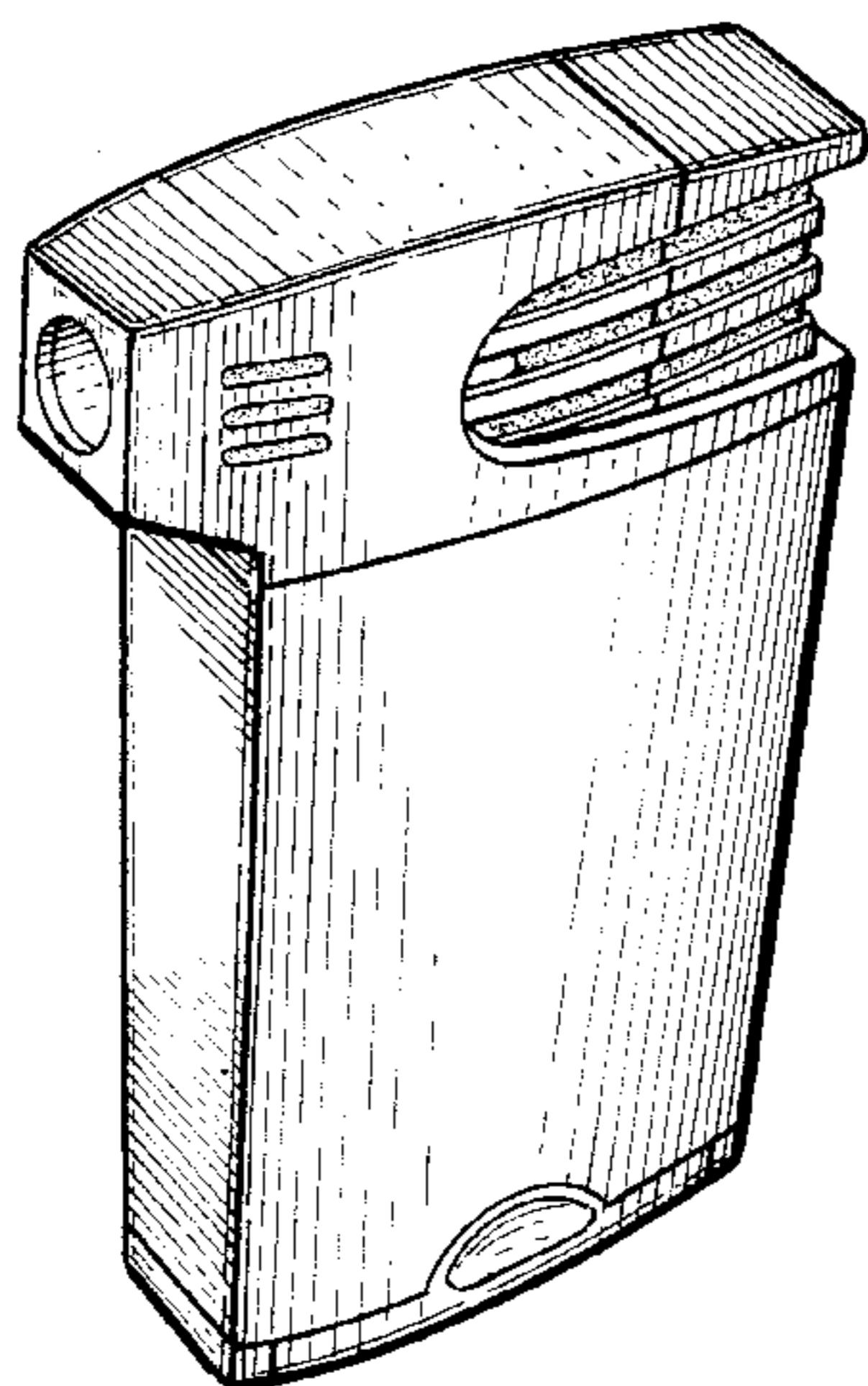

FIGURE 1

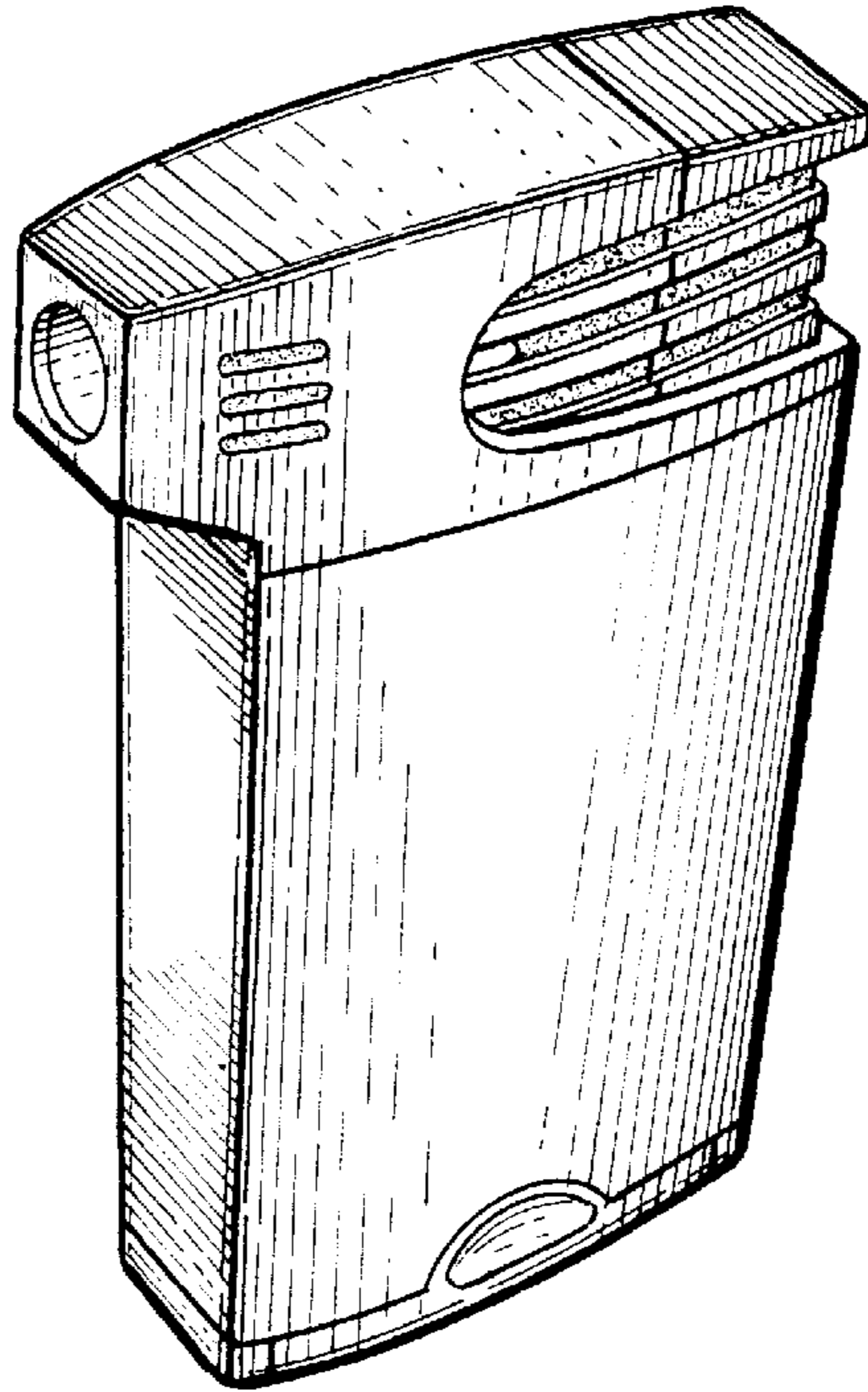

FIGURE 2

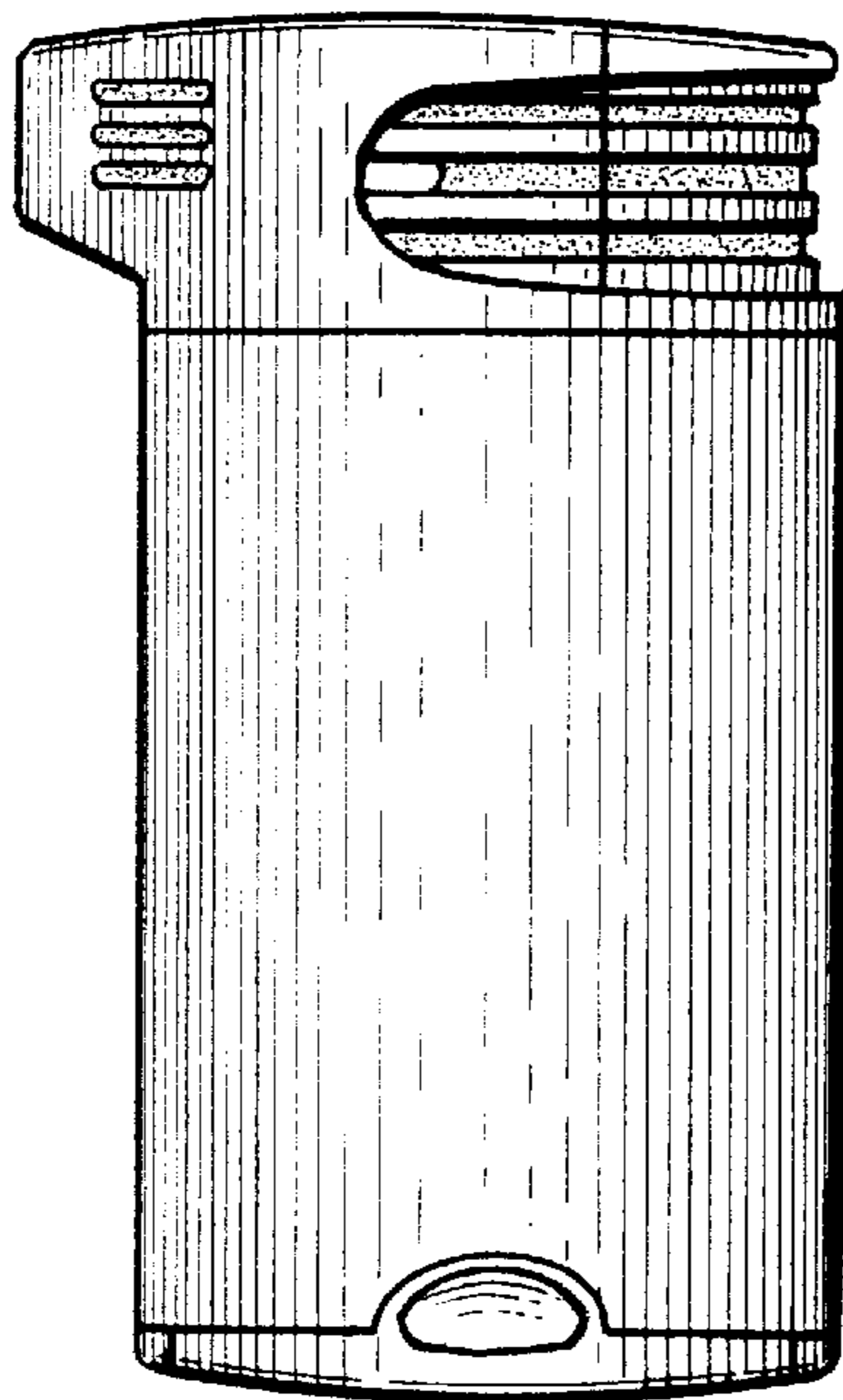

FIGURE 3



FIGURE 4

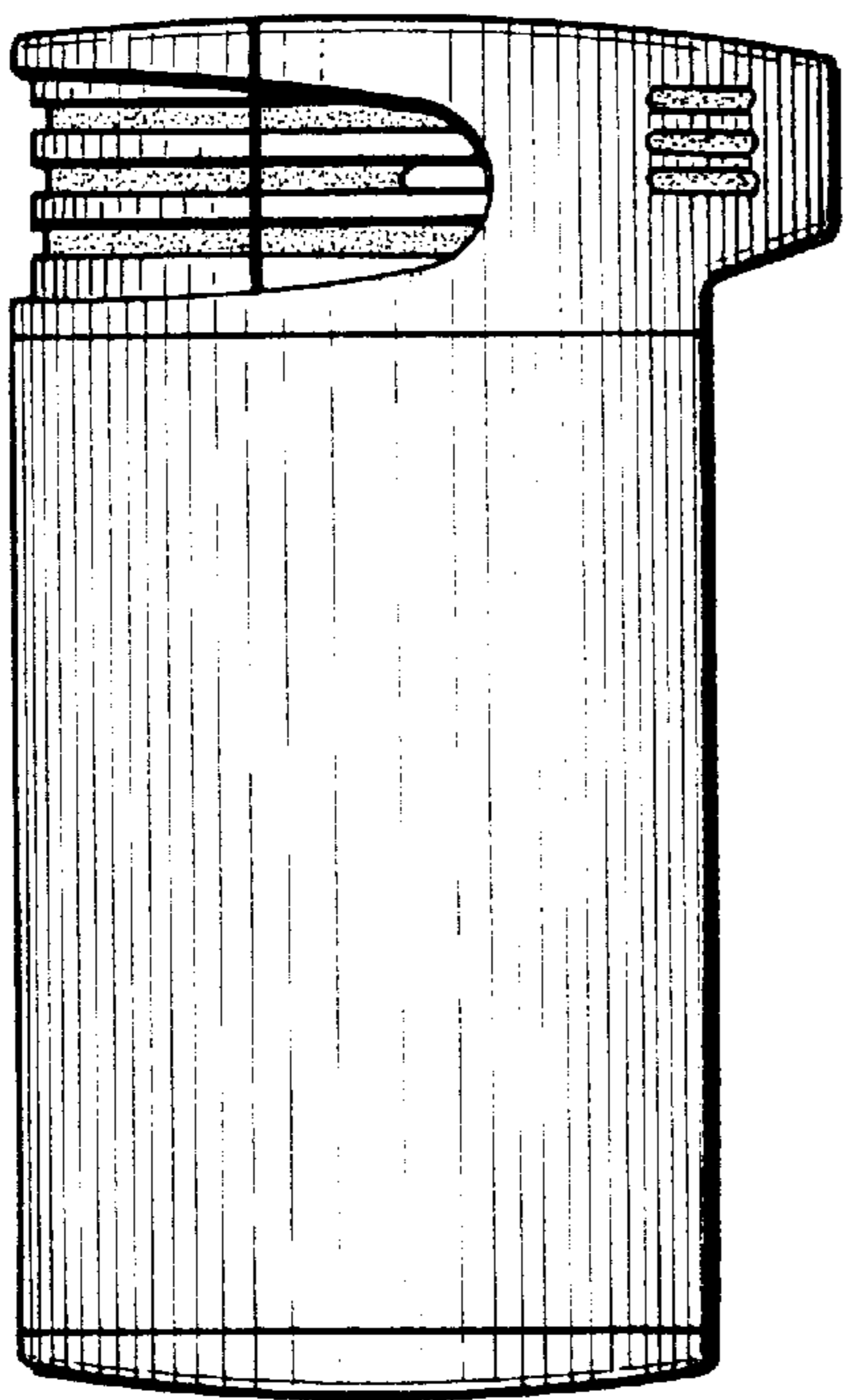

FIGURE 5

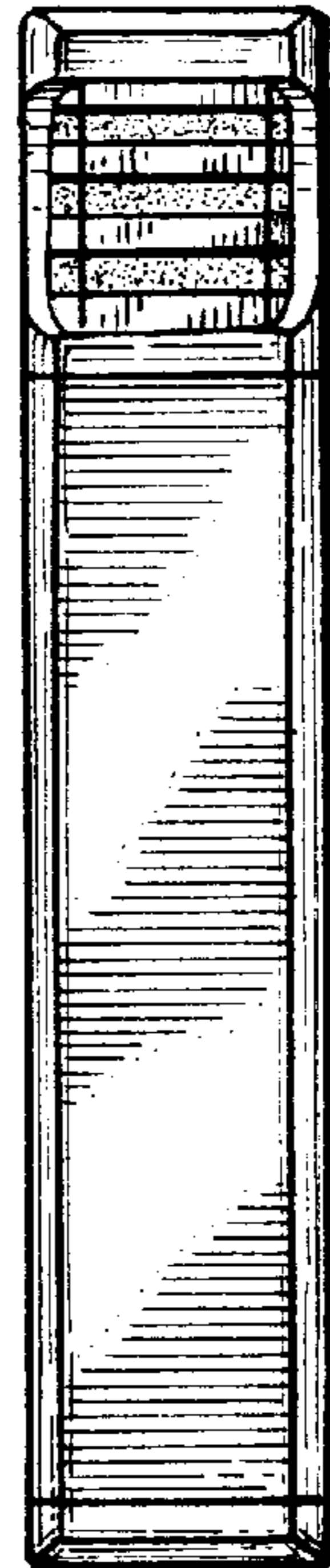

FIGURE 6

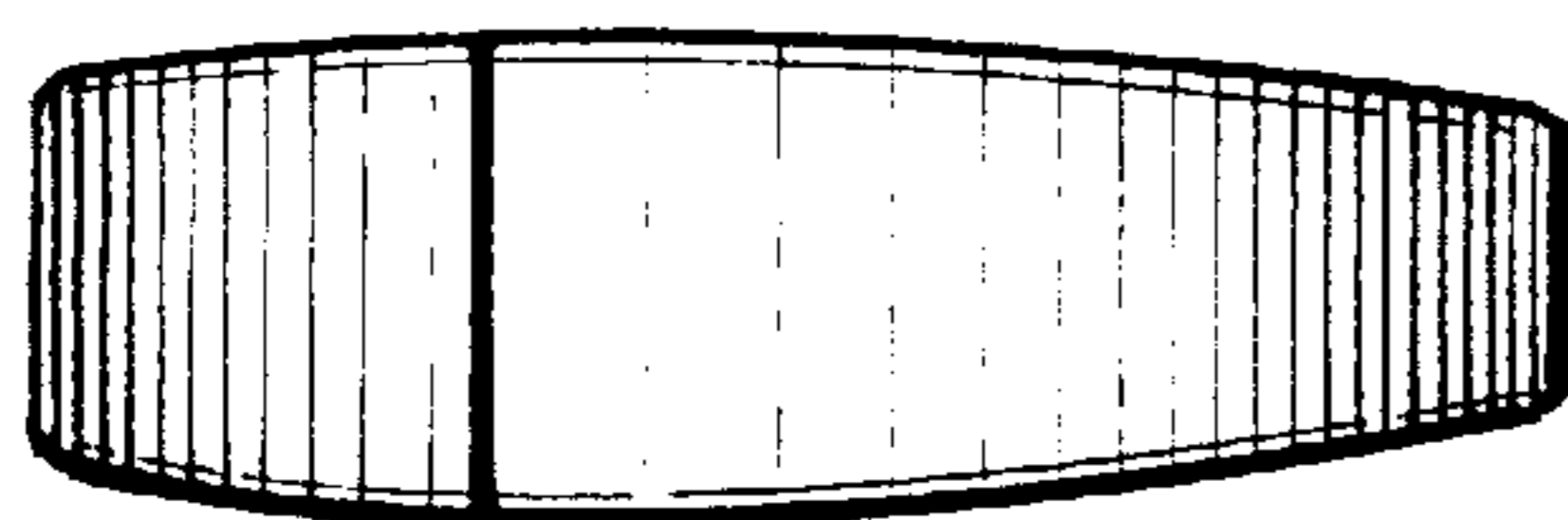

FIGURE 7

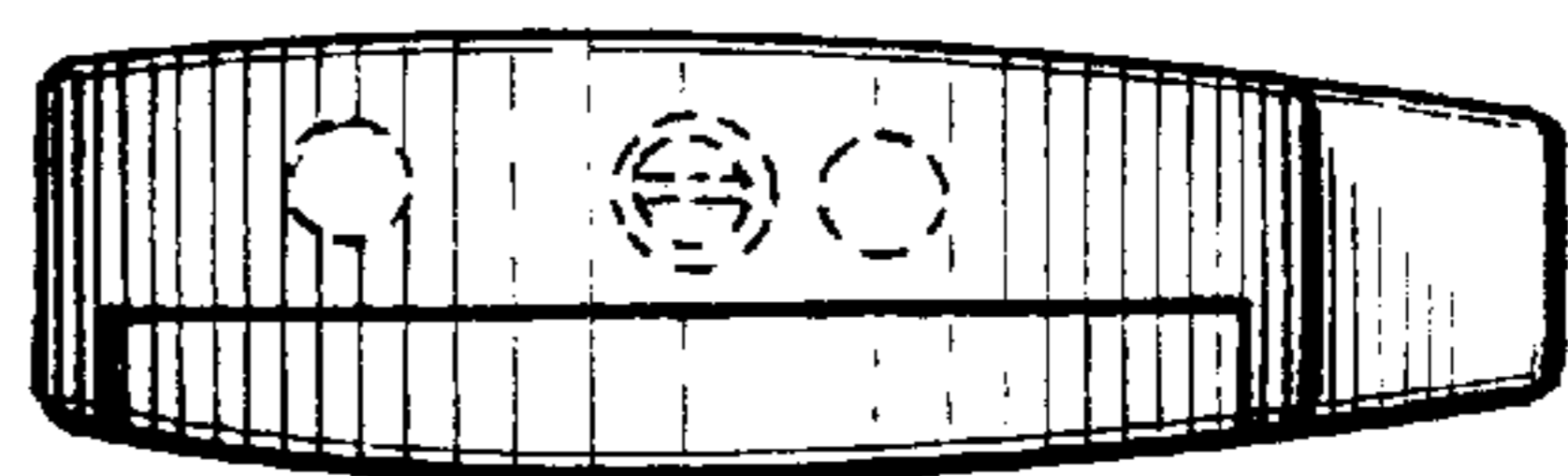

FIGURE 8

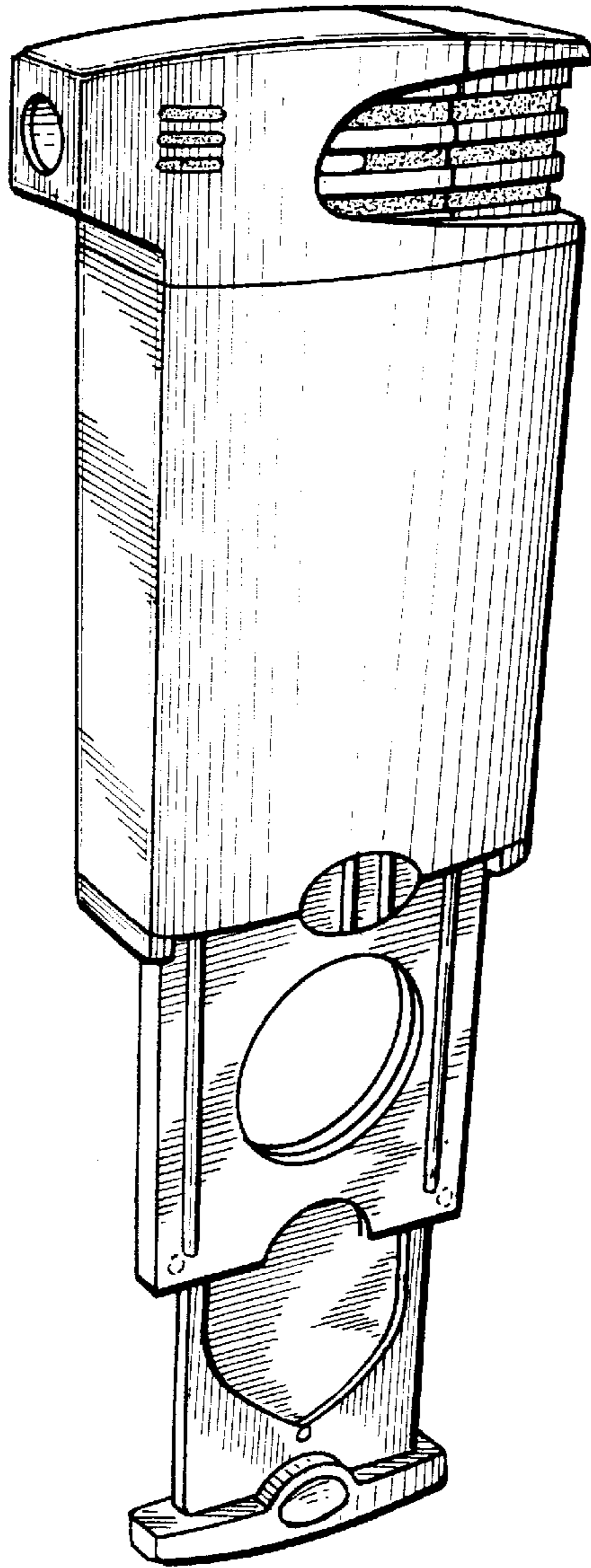

FIGURE 9

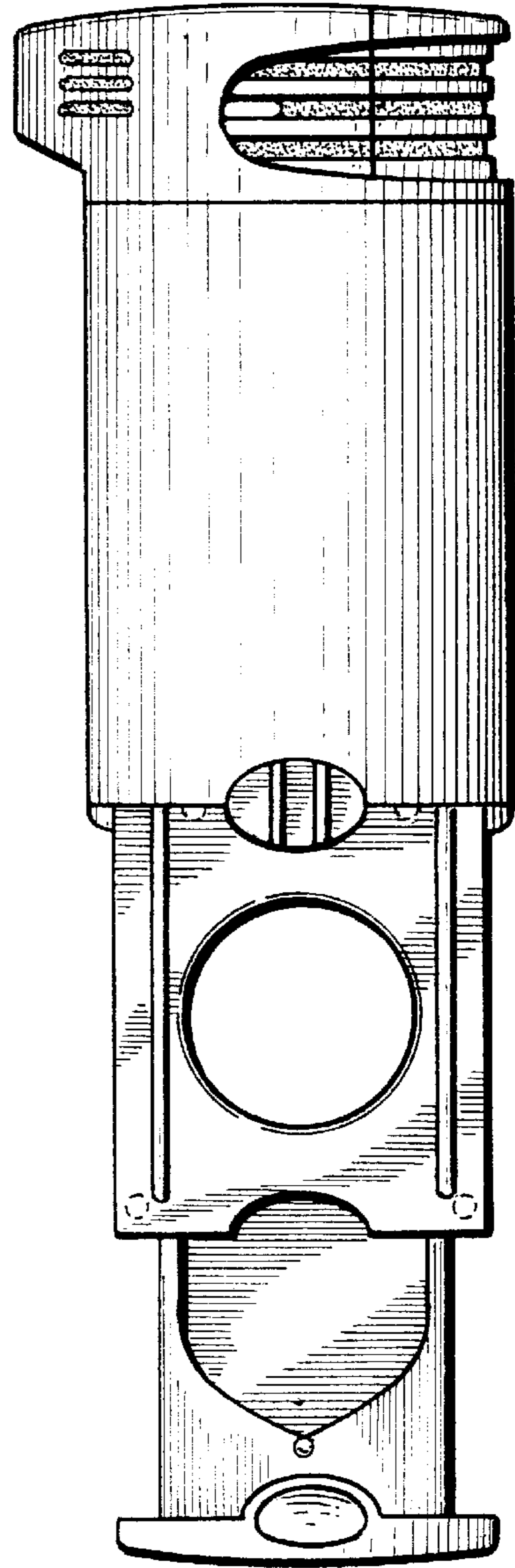

FIGURE 10

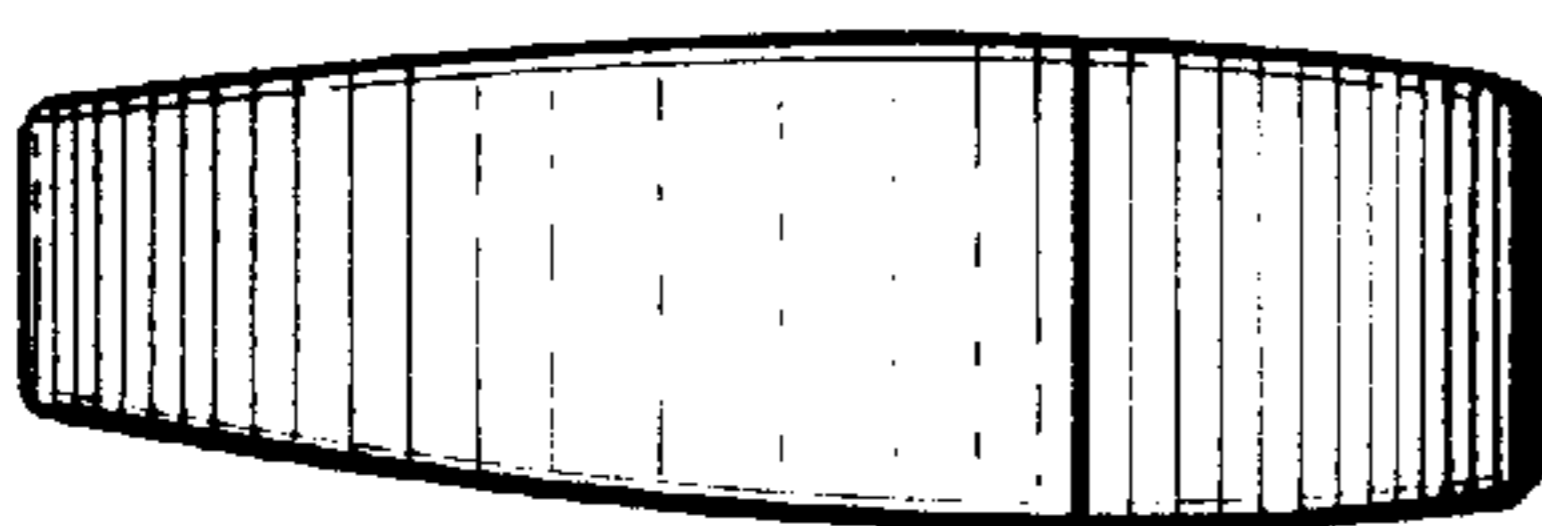

FIGURE 11

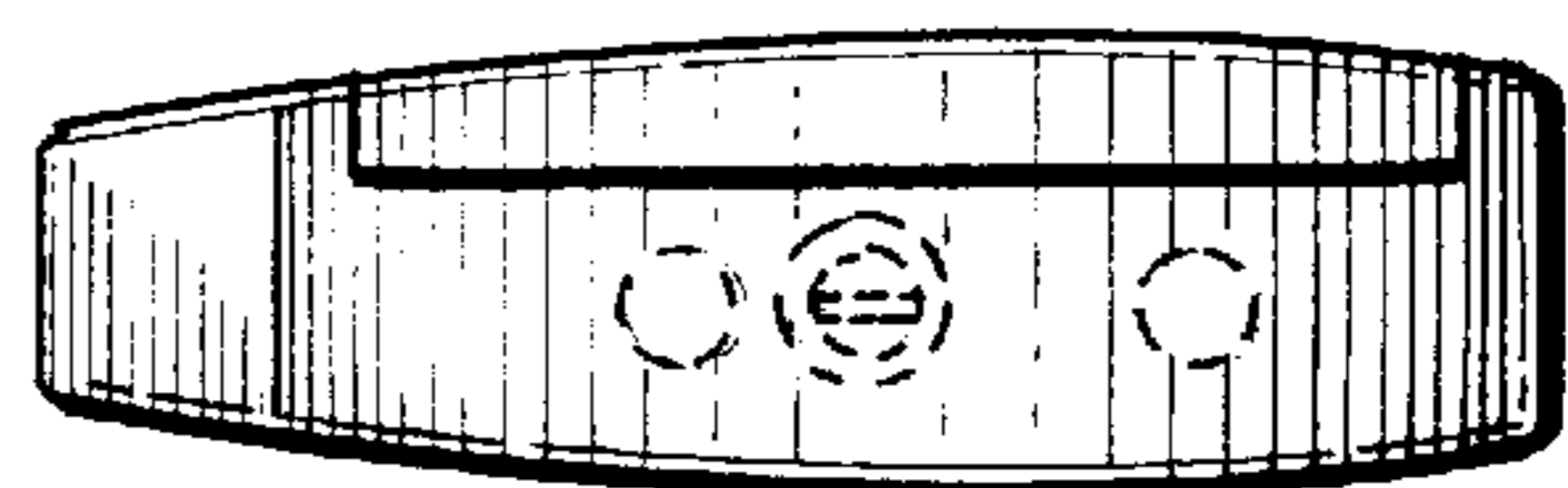

FIGURE 12

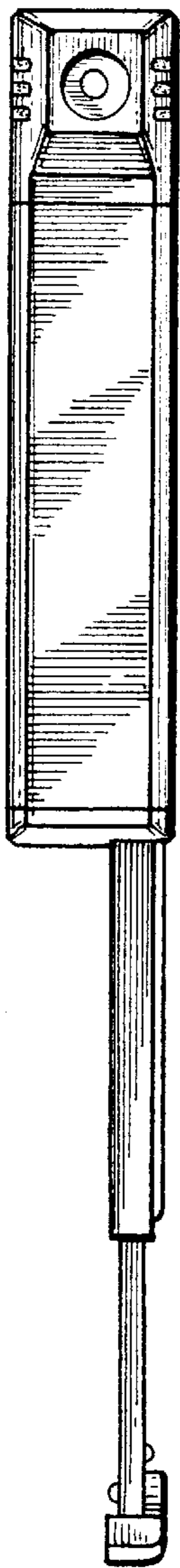

FIGURE 13

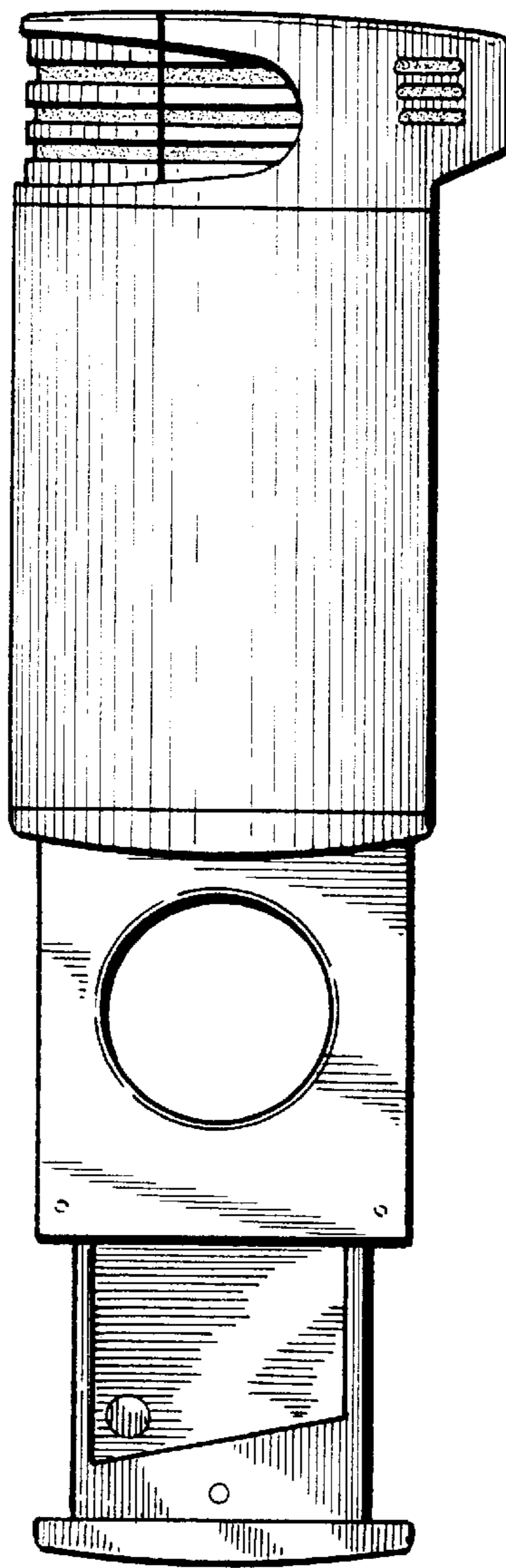

FIGURE 14

