



US00D404454S

United States Patent [19]
Gillis et al.

[11] **Patent Number: Des. 404,454**
[45] **Date of Patent: **Jan. 19, 1999**

[54] **WAKEBOARD SKI BOOT**
[75] Inventors: **Donald B. Gillis**, Lake Stevens;
Douglas A. Cannon, Arlington, both of Wash.
[73] Assignee: **Connelly Skis, Inc.**, Lynnwood, Wash.
[**] Term: **14 Years**
[21] Appl. No.: **81,884**
[22] Filed: **Jan. 7, 1998**
[51] **LOC (6) Cl.** **21-02**
[52] **U.S. Cl.** **D21/773; D21/774**
[58] **Field of Search** **D21/760, 766-774;**
280/607, 613, 617, 618, 14.2

5,181,332 1/1993 Uren et al. .
5,277,635 1/1994 Gillis .
5,334,065 8/1994 Uren et al. .
5,499,837 3/1996 Hale et al. .
5,503,900 4/1996 Fletcher .
5,624,291 4/1997 McClaskey .
5,690,350 11/1997 Turner et al. .

Primary Examiner—Kay H. Chin
Attorney, Agent, or Firm—Christensen, O'Connor, Johnson & Kindness

[57] **CLAIM**

The ornamental design for a wakeboard ski boot, as shown and described.

DESCRIPTION

FIG. 1 is a perspective view of a wakeboard ski boot showing our new design, the broken lines are for illustrative purposes only;
FIG. 2 is a left side view thereof;
FIG. 3 is a right side view thereof;
FIG. 4 is a front view thereof;
FIG. 5 is a rear view thereof;
FIG. 6 is a top view thereof; and,
FIG. 7 is a bottom view thereof.

[56] **References Cited**
U.S. PATENT DOCUMENTS
D. 308,997 7/1990 Kate D21/773
3,360,812 1/1968 Kluge .
3,801,119 4/1974 Andre .
3,965,585 6/1976 Stewart .
4,188,046 2/1980 Fleckenstein .
4,836,571 6/1989 Corbisiero .
4,891,027 1/1990 Plunkett .
4,979,760 12/1990 Derrah .

1 Claim, 4 Drawing Sheets

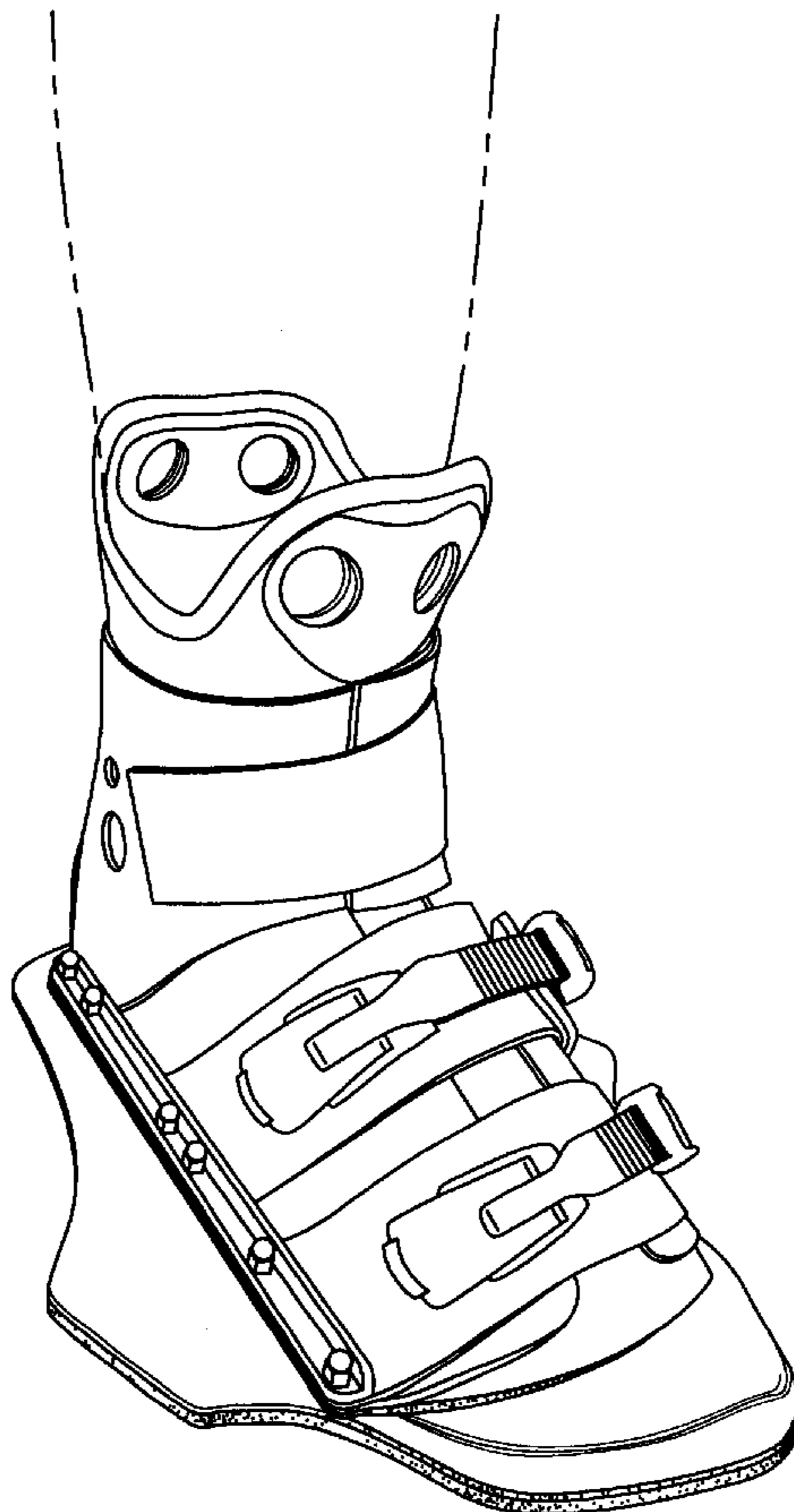

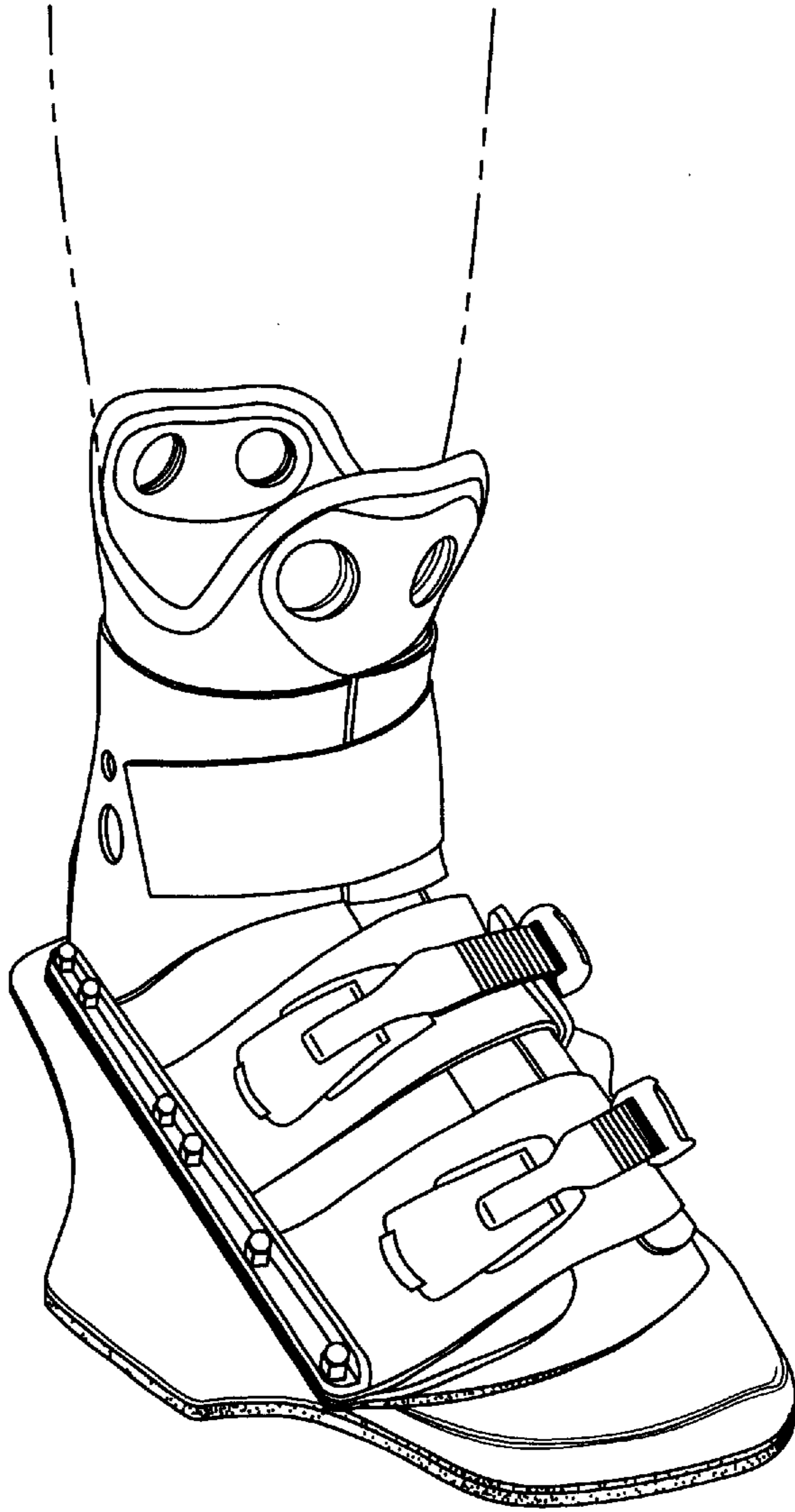

Fig. 1

Fig. 2

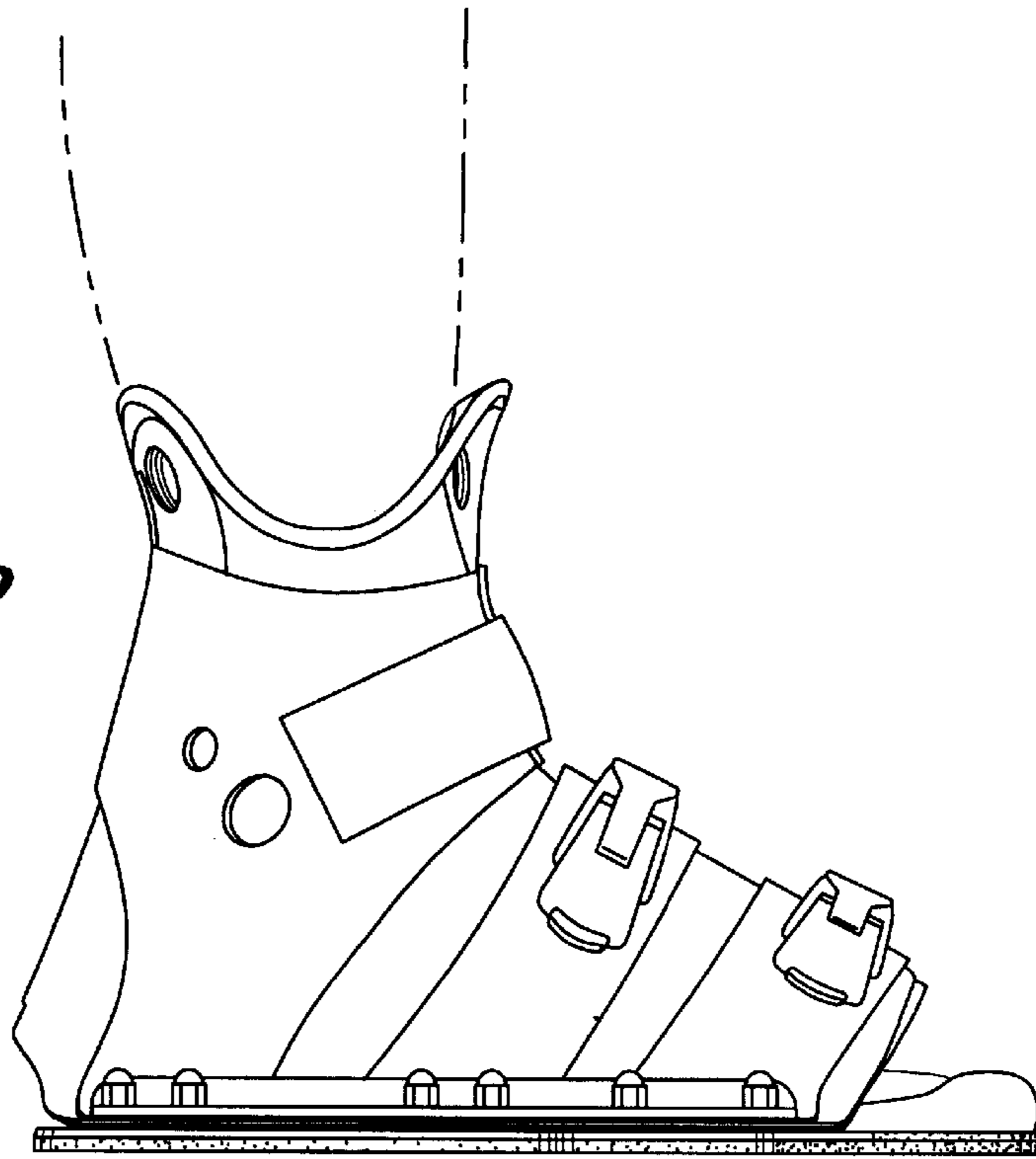

Fig. 3

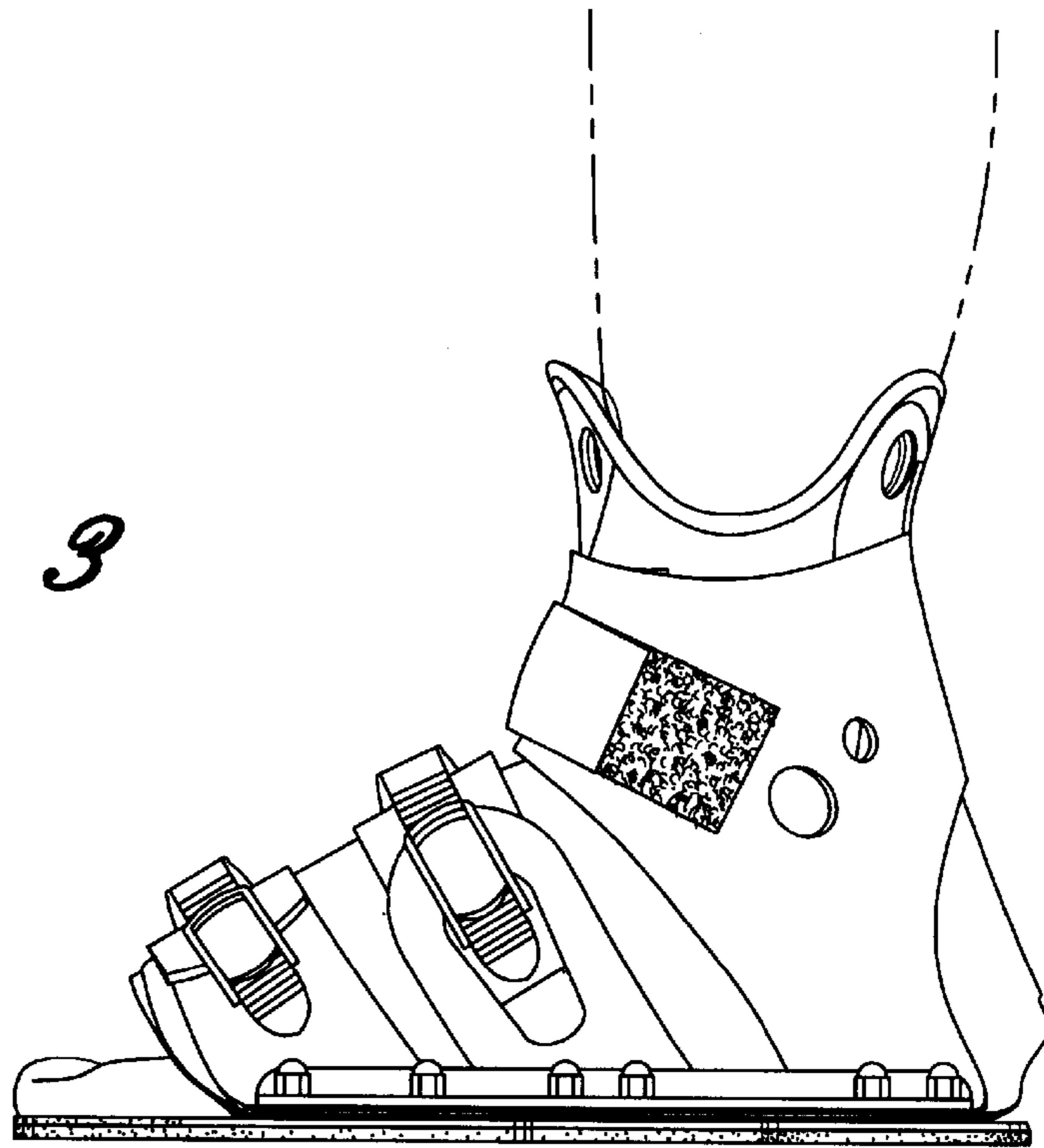

Fig. 4

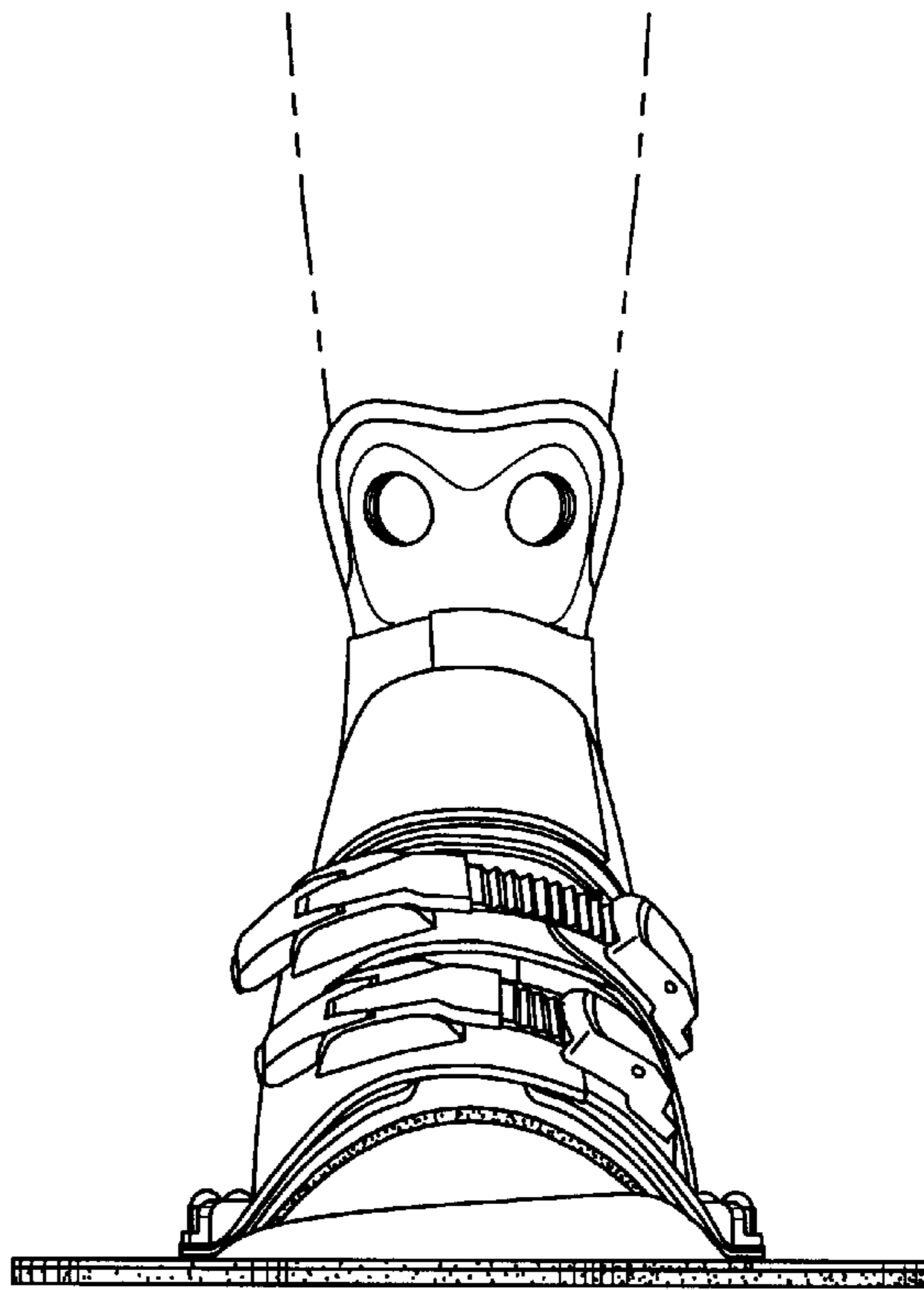
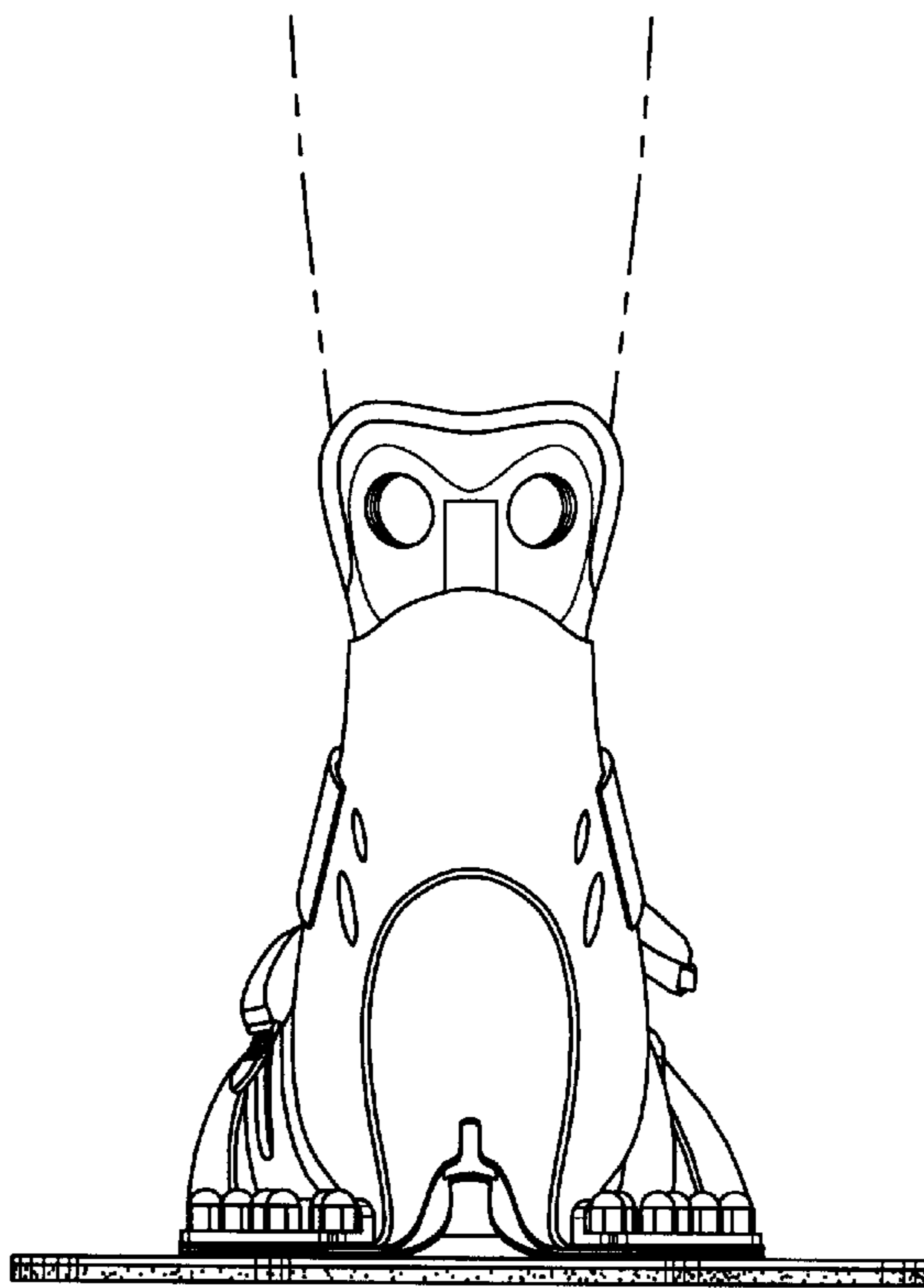

Fig. 5



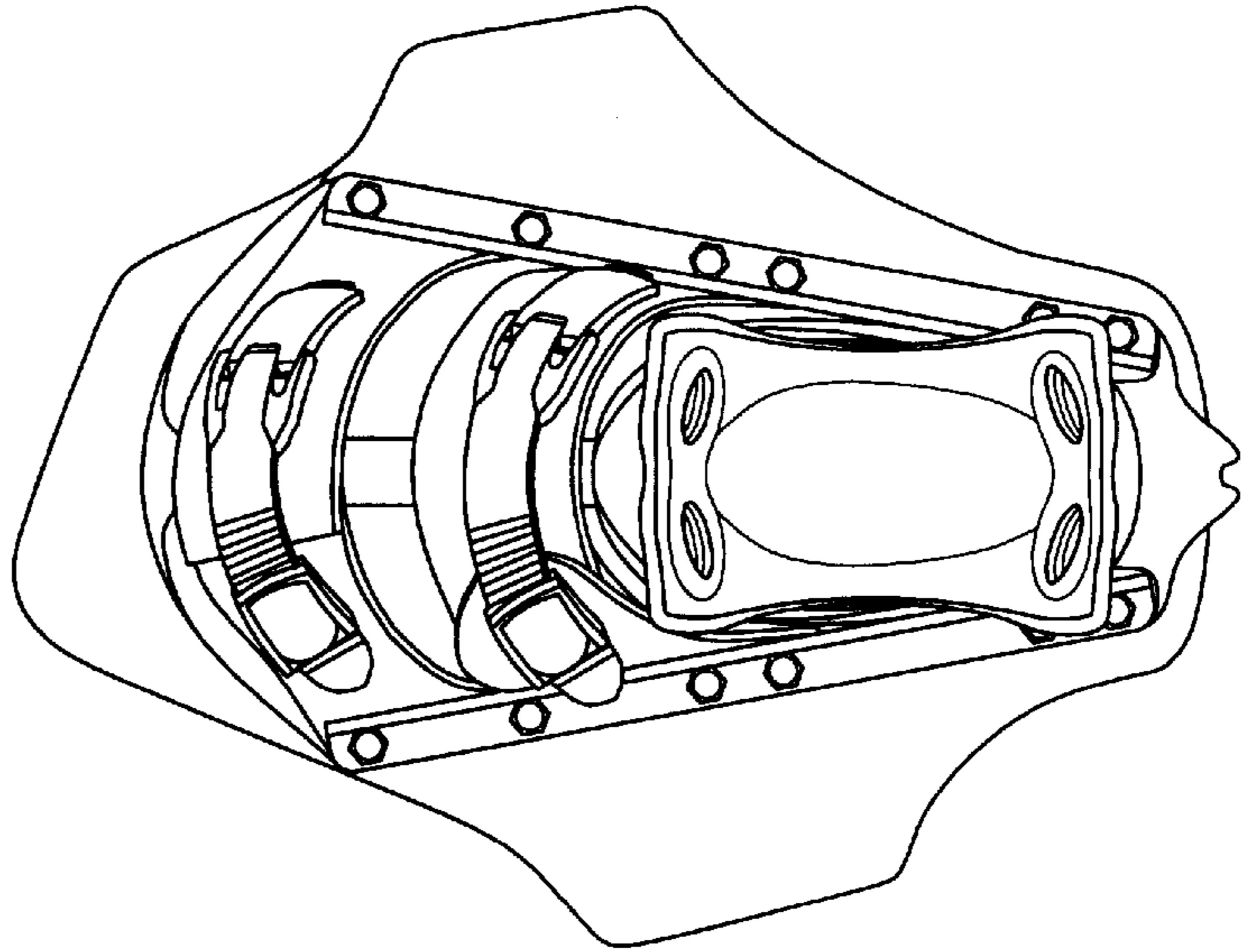

Fig. 6

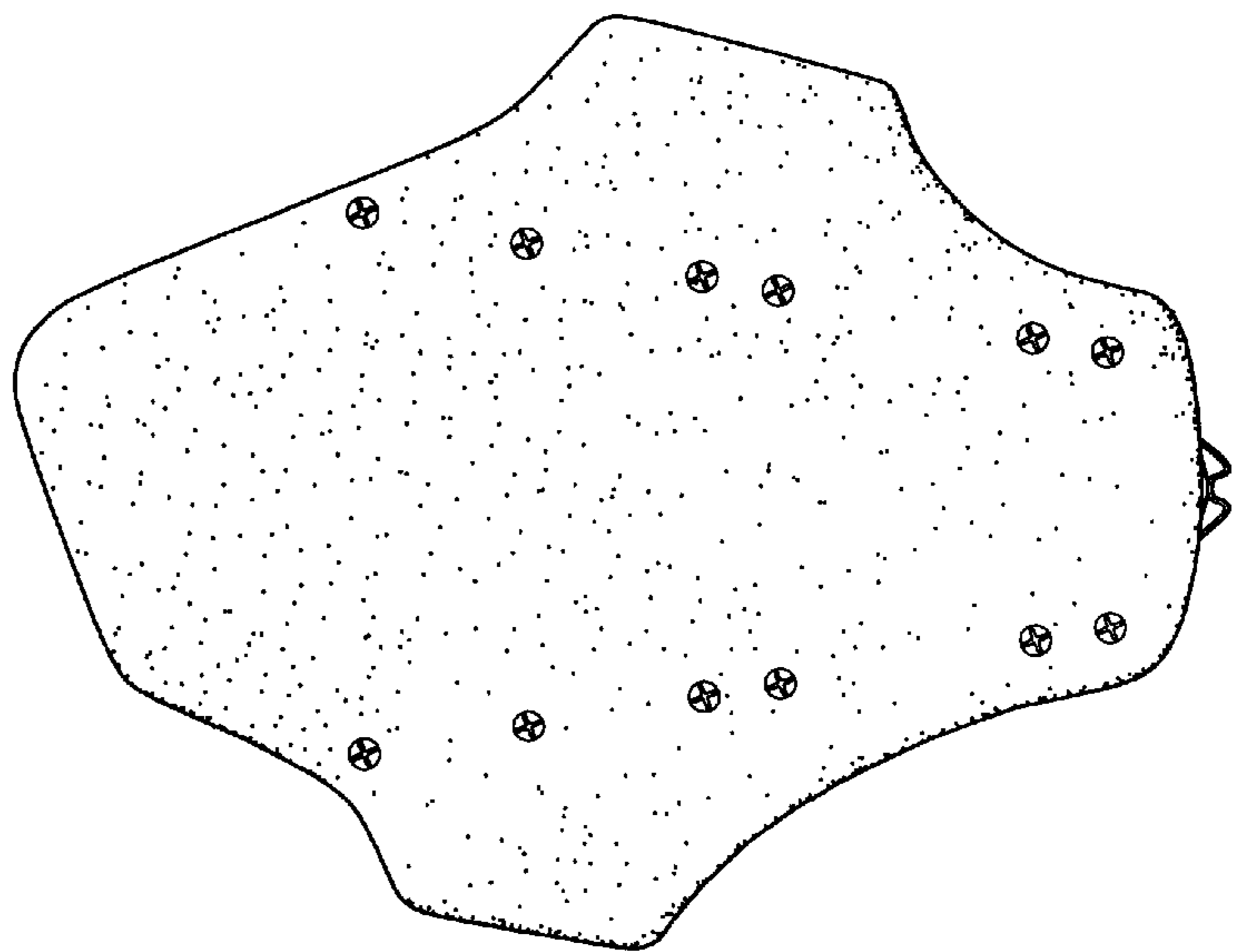

Fig. 7