



US00D404453S

United States Patent [19]

[11] Patent Number: Des. 404,453

Wozny et al.

[45] Date of Patent: **Jan. 19, 1999

[54] GOLF CLUBHEAD

FOREIGN PATENT DOCUMENTS

[75] Inventors: **Thomas A. Wozny**, Mt. Prospect;
Mark A. Chesney, Evanston; **Jon C. Pergande**, Des Plaines, all of Ill.

2117254 3/1983 United Kingdom .
WO 93/20904 10/1993 WIPO .

[73] Assignee: **Wilson Sporting Goods Co.**, Chicago, Ill.

Primary Examiner—Ted Shooman
Assistant Examiner—Mitchell I. Siegel

[**] Term: **14 Years**

[57] CLAIM

The ornamental design for a golf clubhead, as shown and described.

[21] Appl. No.: **82,132**

DESCRIPTION

[22] Filed: **Jan. 15, 1998**

[51] **LOC (6) Cl.** **21-02**

[52] **U.S. Cl.** **D21/749**

[58] **Field of Search** D21/747-752;
473/324, 327, 328, 350

FIG. 1 is a front elevational view of the golf clubhead; FIG. 2 is a top plan view of the golf clubhead of FIG. 1; FIG. 3 is a bottom plan view of the golf clubhead of FIG. 1; FIG. 4 is a left side elevational view of the golf clubhead of FIG. 1; FIG. 5 is a right side elevational view of the golf clubhead of FIG. 1; FIG. 6 is a rear elevational view of the golf clubhead of FIG. 1; FIG. 7 is a sectional view taken along the line 7—7 of FIG. 1; FIG. 8 is a sectional view taken along the line 8—8 of FIG. 1; FIG. 9 is a sectional view taken along the line 9—9 of FIG. 1; FIG. 10 is a front elevational view of a second embodiment of the golf clubhead as disclosed in FIG. 1; FIG. 11 is a top plan view of the golf clubhead of FIG. 10; FIG. 12 is a bottom plan view of the golf clubhead of FIG. 10; FIG. 13 is a left side elevational view of the golf clubhead of FIG. 10; FIG. 14 is a right side elevational view of the golf clubhead of FIG. 10; FIG. 15 is a rear elevational view of the golf clubhead of FIG. 10; FIG. 16 is a sectional view taken on line 16—16 of FIG. 10; FIG. 17 is a sectional view taken on line 17—17 of FIG. 10; FIG. 18 is a sectional view taken on line 18—18 of FIG. 10; FIG. 19 is a front elevational view of a third embodiment of the golf clubhead as disclosed in FIG. 1; FIG. 20 is a top plan view of the golf clubhead of FIG. 19; FIG. 21 is a bottom plan view of the golf clubhead of FIG. 19;

[56] References Cited

U.S. PATENT DOCUMENTS

D. 240,841	8/1976	Solheim	D21/748
D. 256,264	8/1980	Solheim	.	
D. 354,786	1/1995	Manning et al.	D21/748
D. 372,285	7/1996	Fortini	D21/748
D. 375,769	11/1996	Hutin et al.	D21/749
D. 382,616	8/1997	Heffley	D21/749
3,722,887	3/1973	Cochran et al.	.	
3,955,820	5/1976	Cochran et al.	.	
3,995,865	12/1976	Cochran et al.	.	
4,715,601	12/1987	Lamanna	.	
4,754,977	7/1988	Sahm	.	
4,907,806	3/1990	Antonious	.	
4,915,386	4/1990	Antonious	.	
5,026,056	6/1991	McNally et al.	.	
5,046,733	9/1991	Antonious	.	
5,048,835	9/1991	Gorman	.	
5,224,705	7/1993	Scheie et al.	.	
5,242,167	9/1993	Antonious	.	
5,316,298	5/1994	Hutin et al.	.	
5,328,184	7/1994	Antonious	.	
5,333,872	8/1994	Manning et al.	.	
5,547,194	8/1996	Aizawa et al.	.	
5,586,947	12/1996	Hutin	.	
5,688,187	11/1997	Duncan	473/350 X

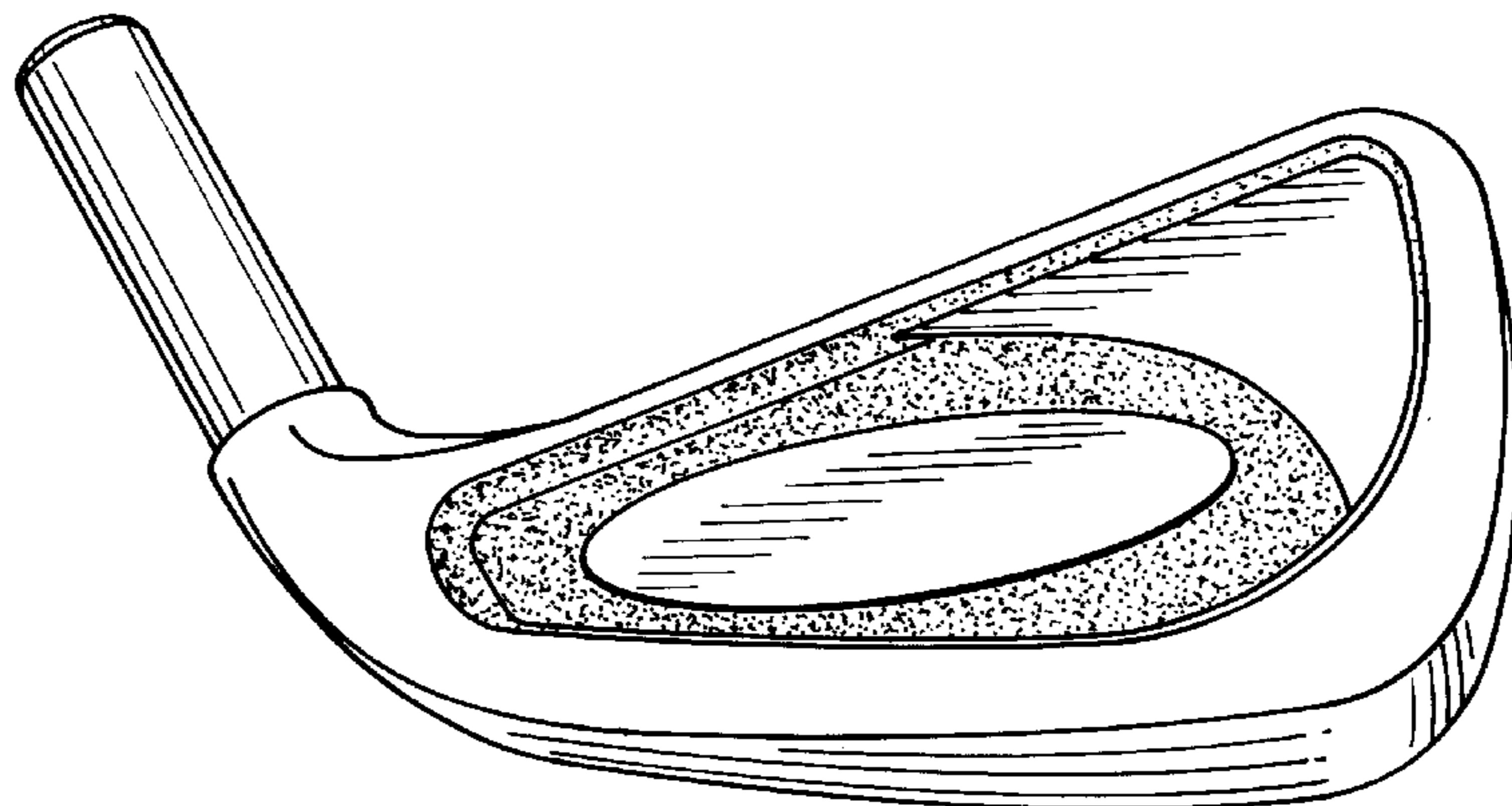

FIG. 22 is a left side elevational view of the golf clubhead of FIG. 19;

FIG. 23 is a right side elevational view of the golf clubhead of FIG. 19;

FIG. 24 is a rear elevational view of the golf clubhead of FIG. 19;

FIG. 25 is a sectional view taken on line 25—25 of FIG. 19;

FIG. 26 is a sectional view taken on line 26—26 of FIG. 19;

FIG. 27 is a sectional view taken on line 27—27 of FIG. 19;

FIG. 28 is a front elevational view of a forth embodiment of the golf clubhead as disclosed in FIG. 1;

FIG. 29 is a top plan view of the golf clubhead of FIG. 28;

FIG. 30 is a bottom plan view of the golf clubhead of FIG. 28;

FIG. 31 is a left side elevational view of the golf clubhead of FIG. 28;

FIG. 32 is a right side elevational view of the golf clubhead of FIG. 28;

FIG. 33 is a rear elevational view of the golf clubhead of FIG. 28;

FIG. 34 is a sectional view taken on line 34—34 of FIG. 28;

FIG. 35 is a sectional view taken on line 35—35 of FIG. 28; and,

FIG. 36 is a sectional view taken on line 36—36 of FIG. 28.

1 Claim, 8 Drawing Sheets

FIG. 2

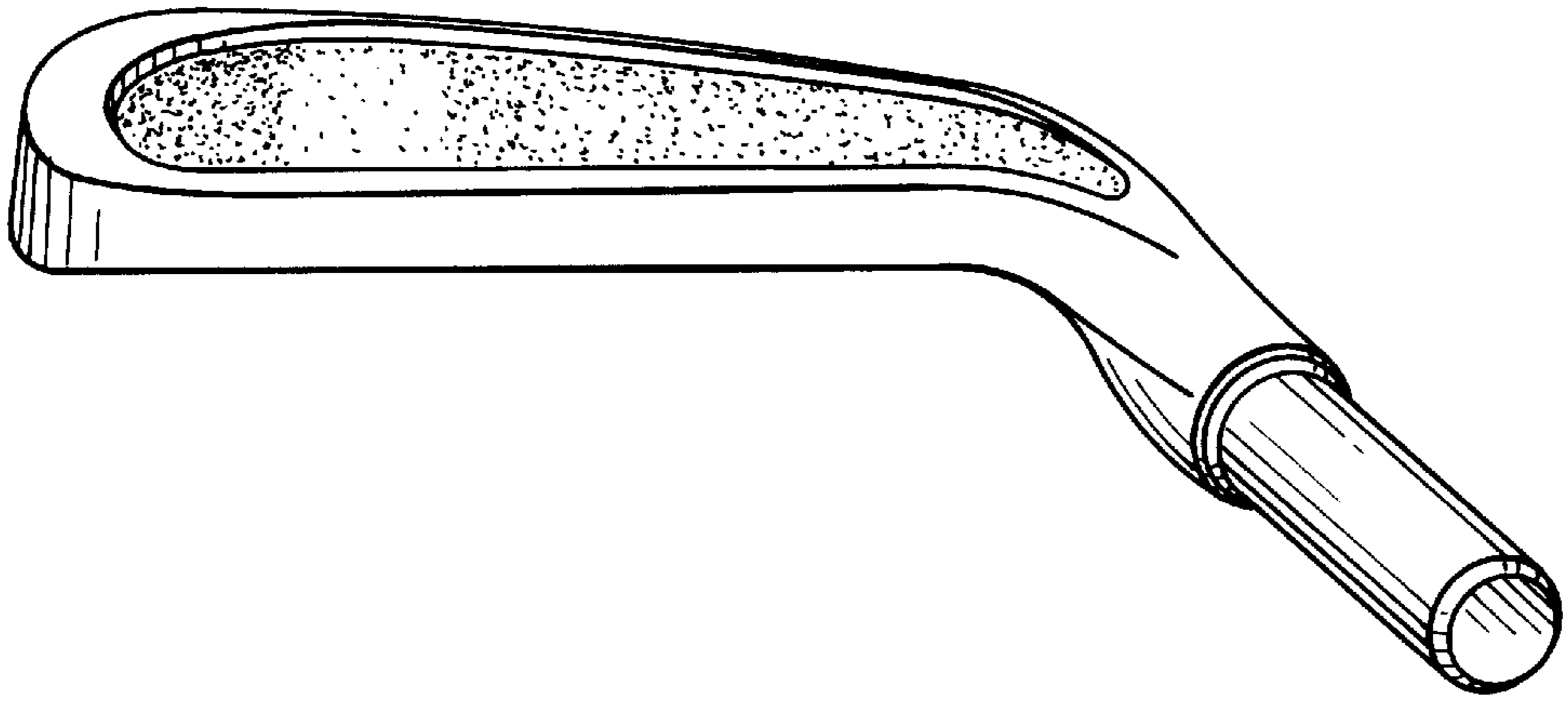

FIG. 1

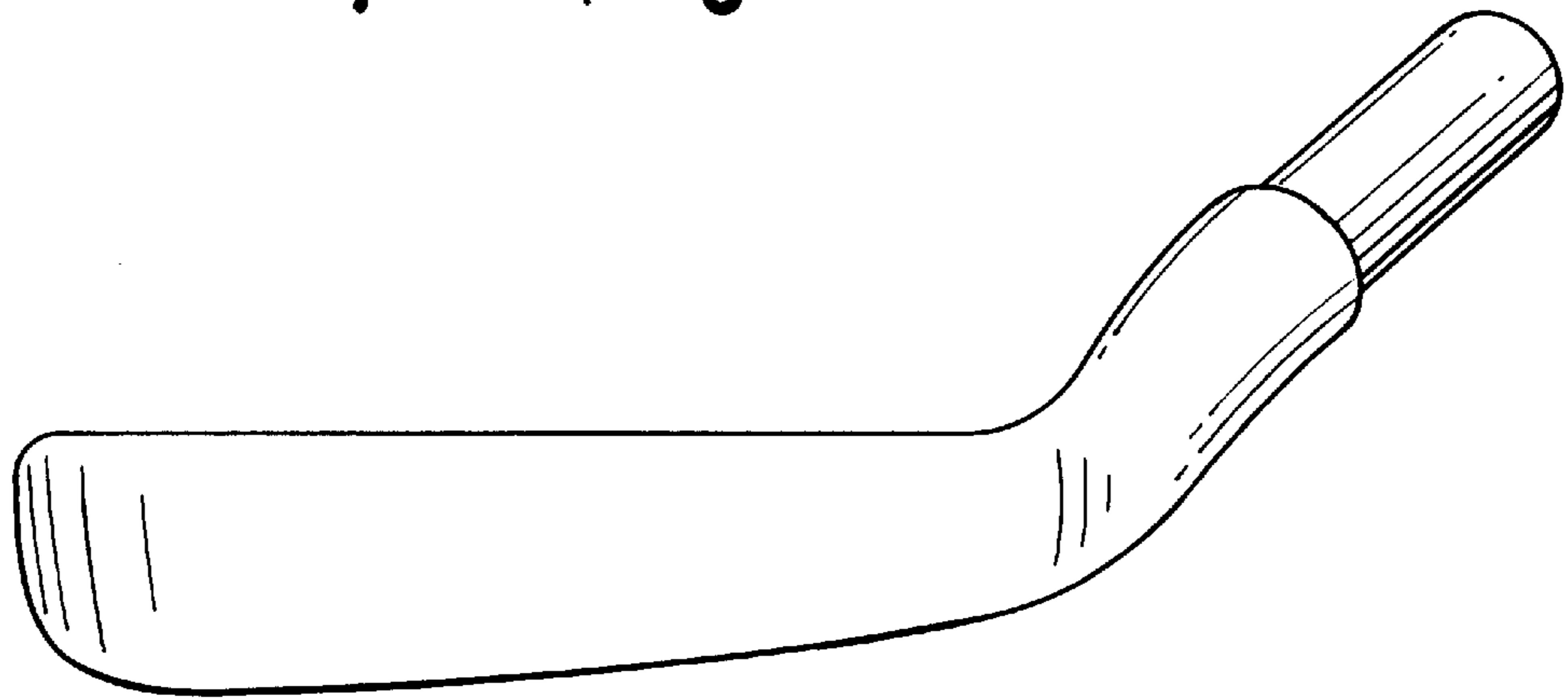
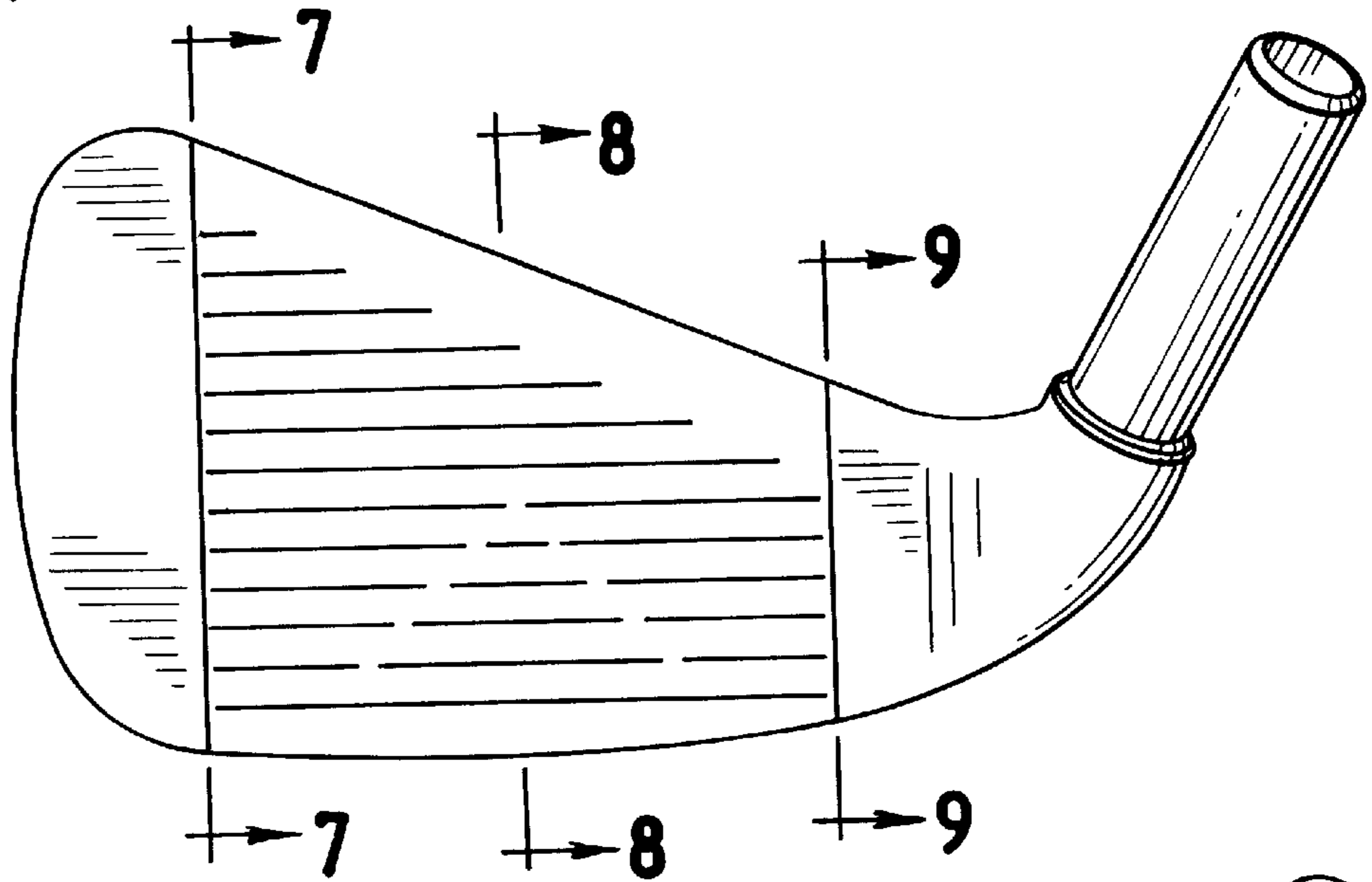

FIG. 3

FIG. 4

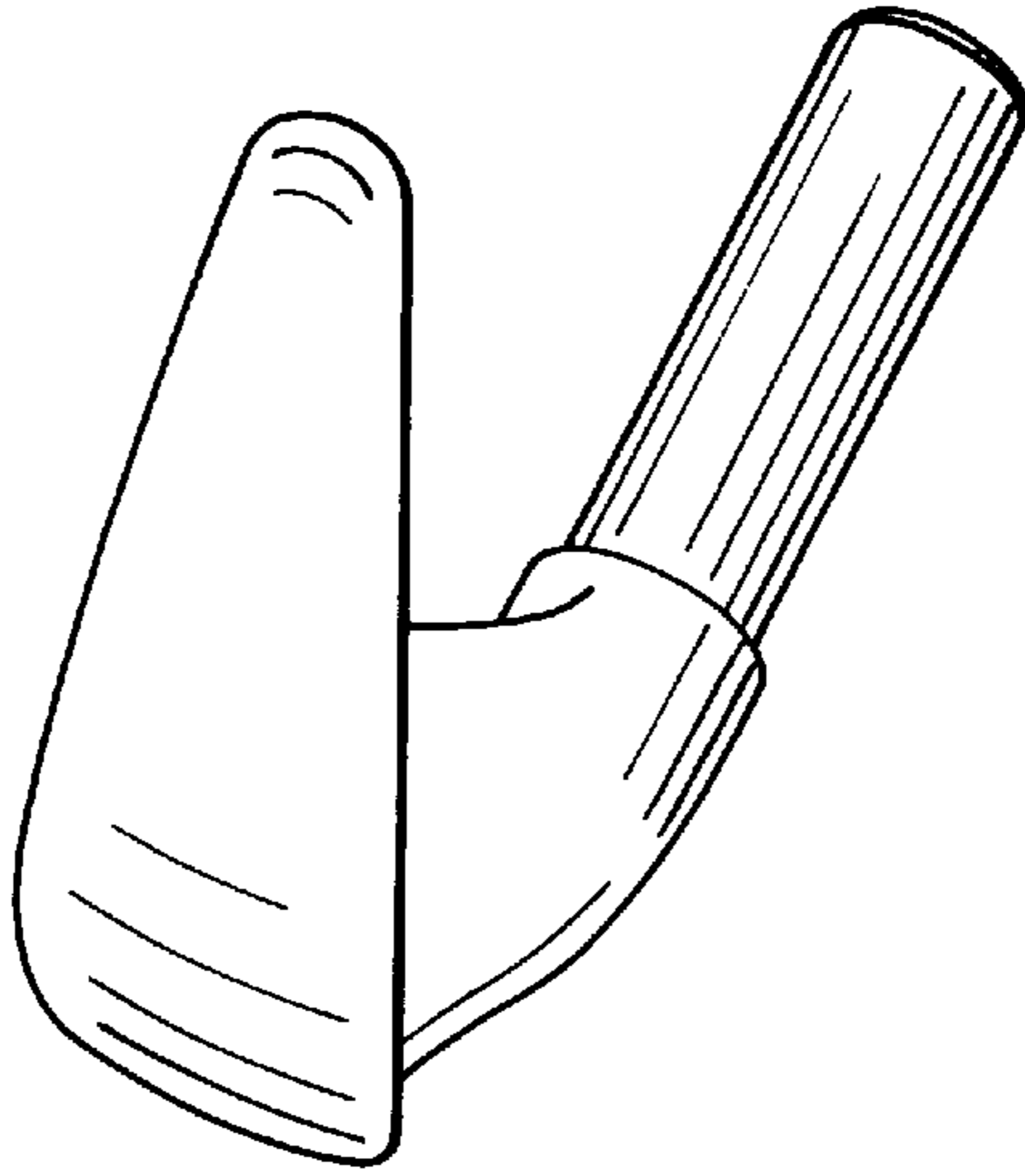

FIG. 5

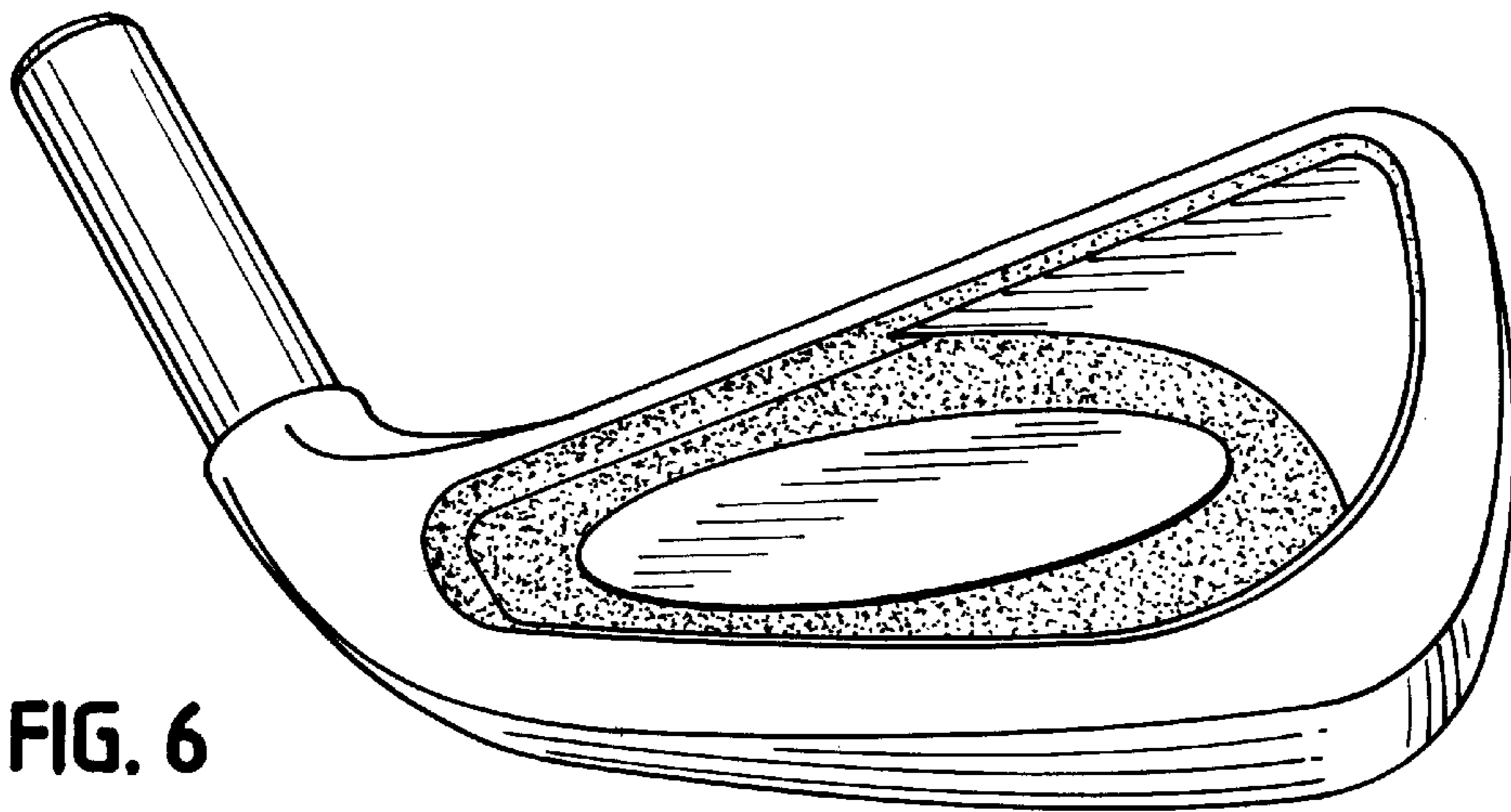
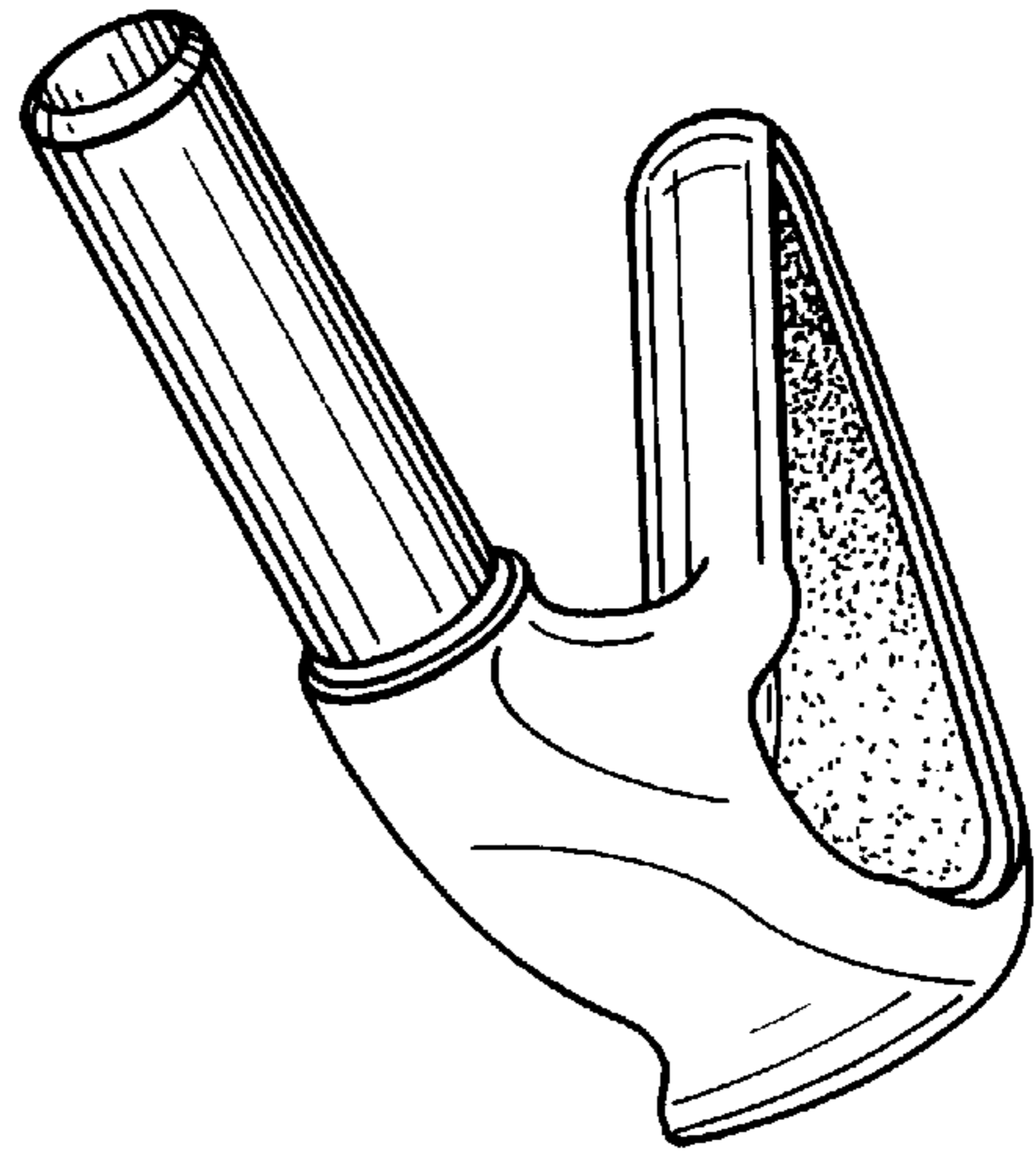

FIG. 6

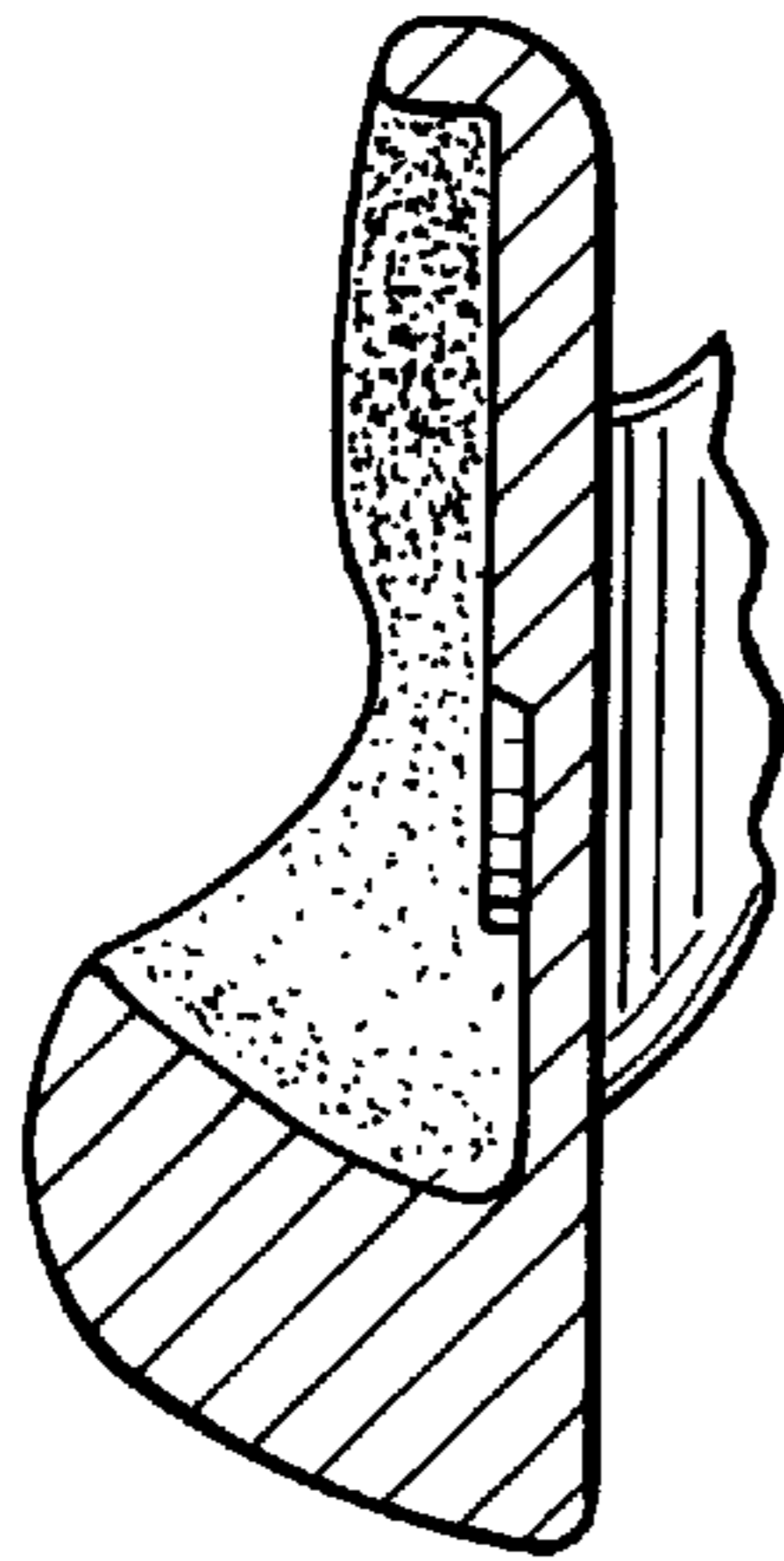

FIG. 7

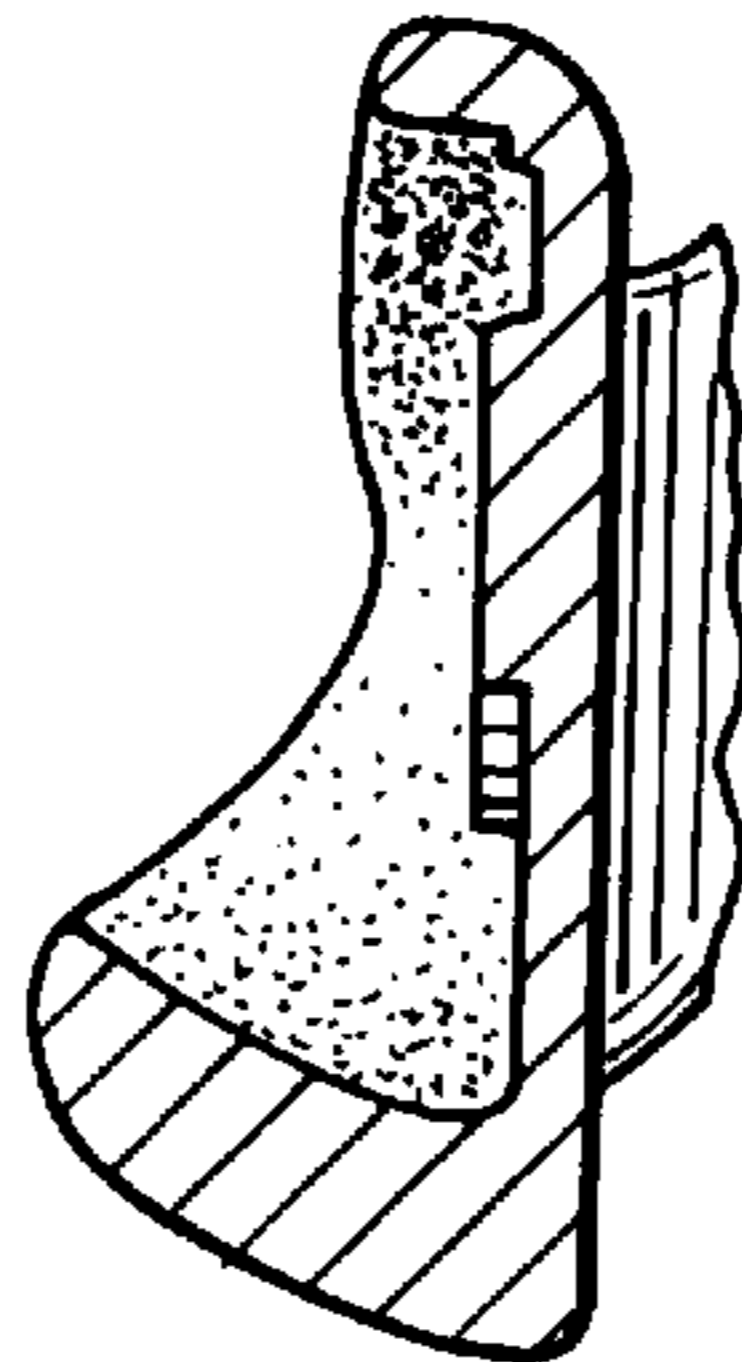

FIG. 8

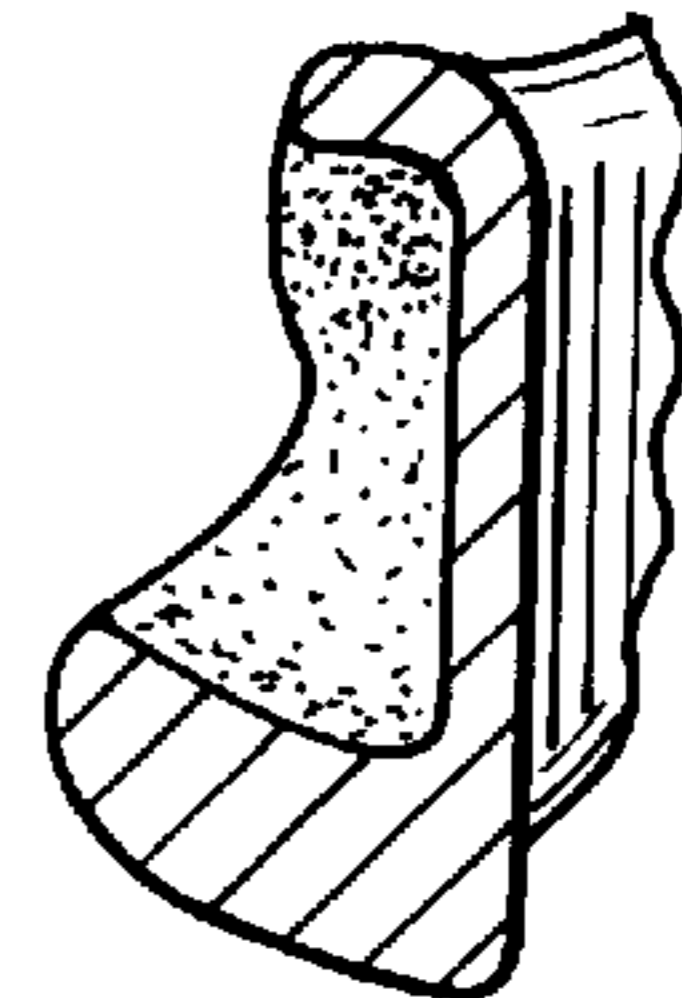

FIG. 9

FIG. 11

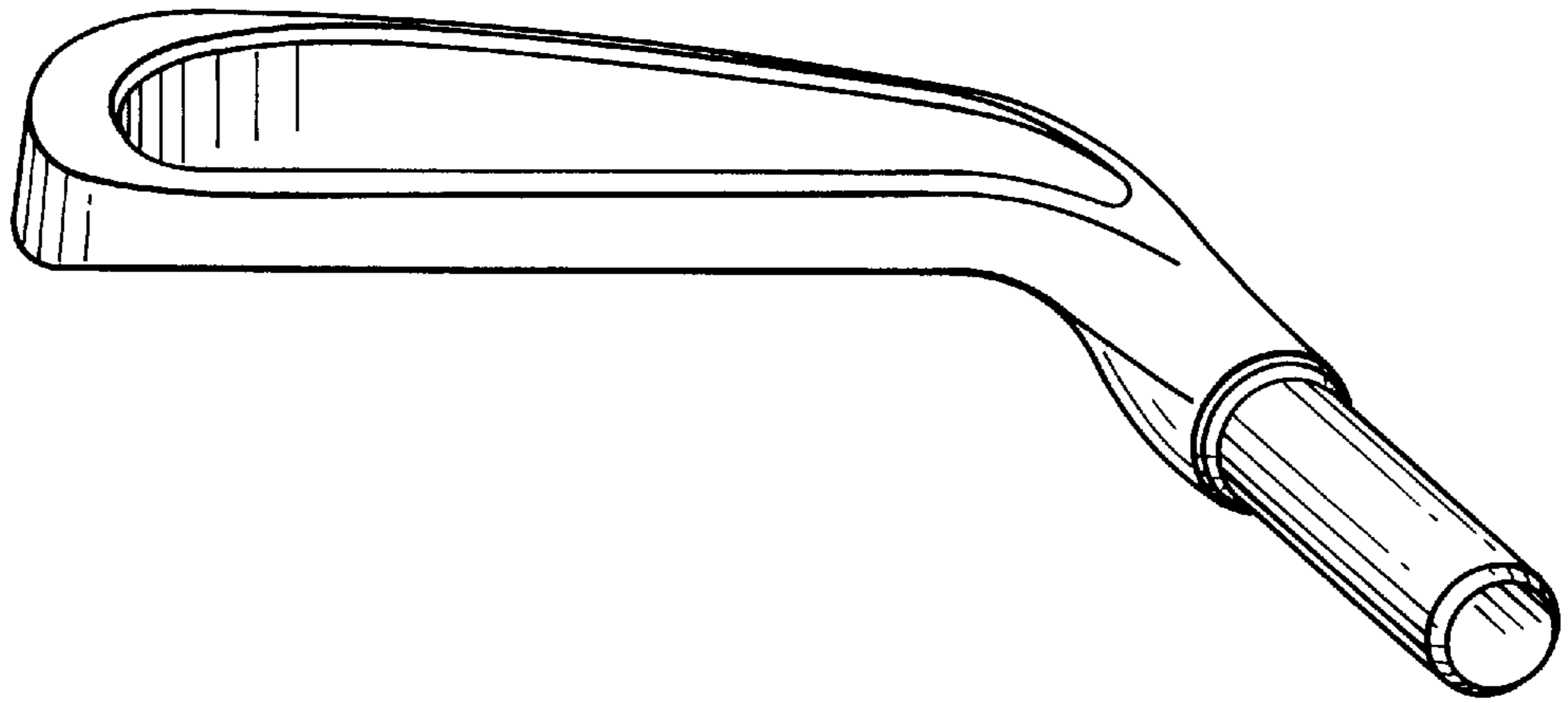

FIG. 10

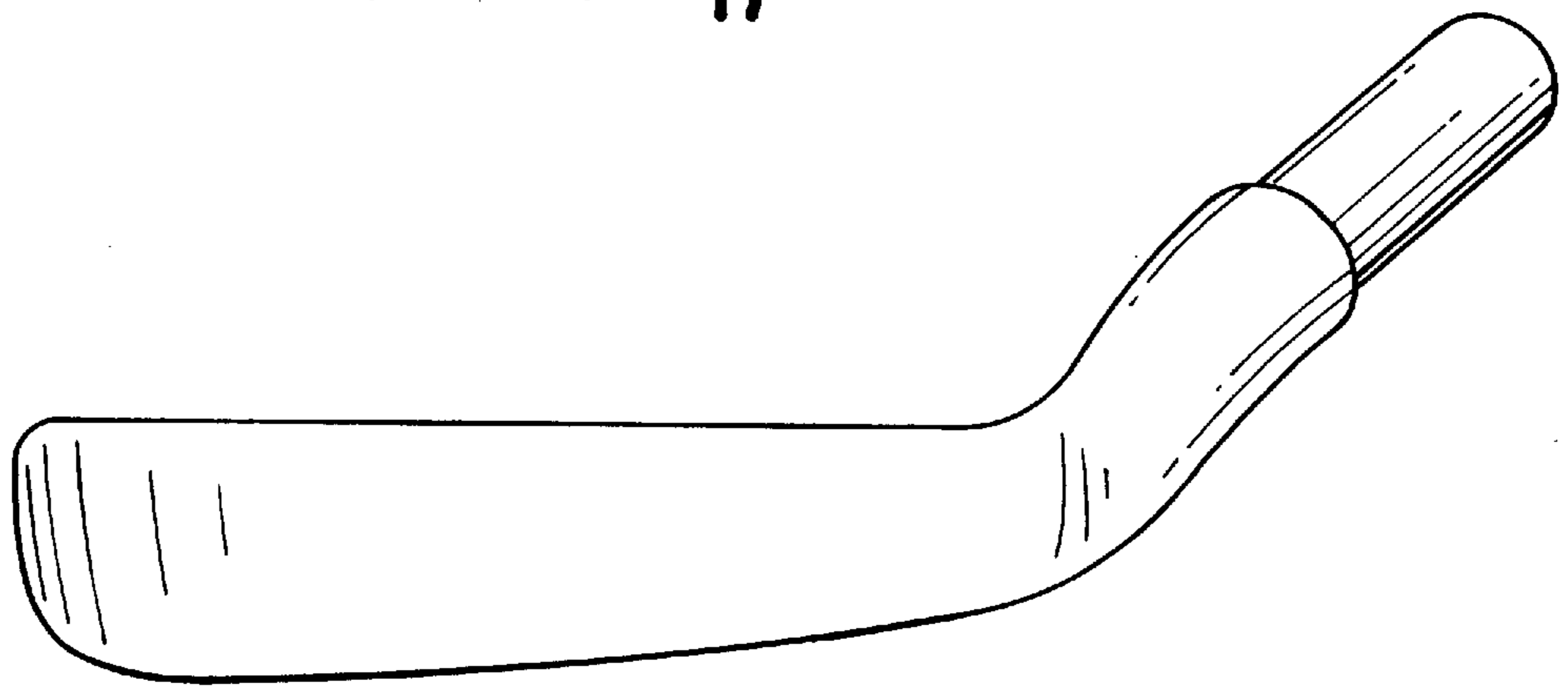
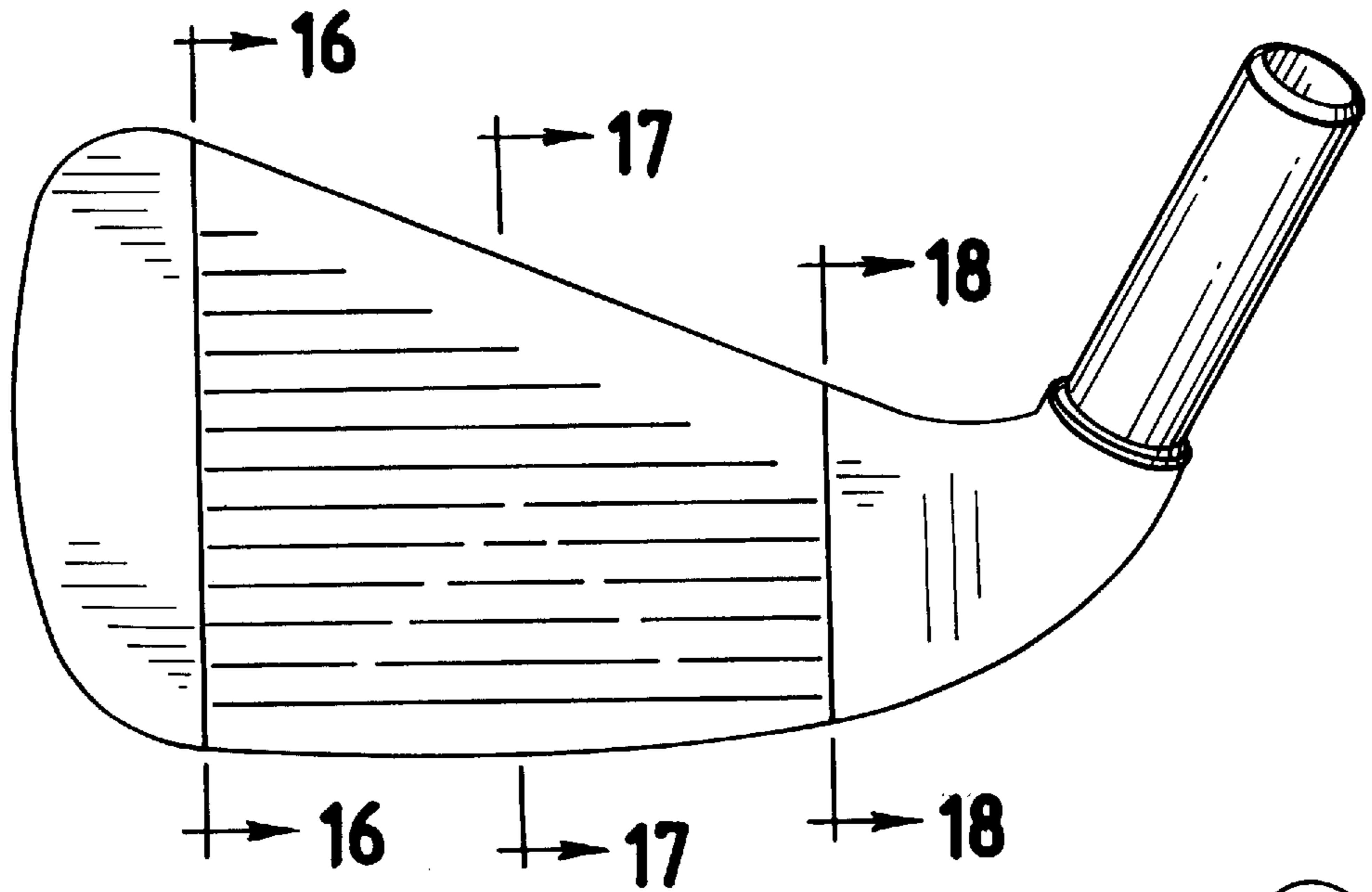

FIG. 12

FIG. 13

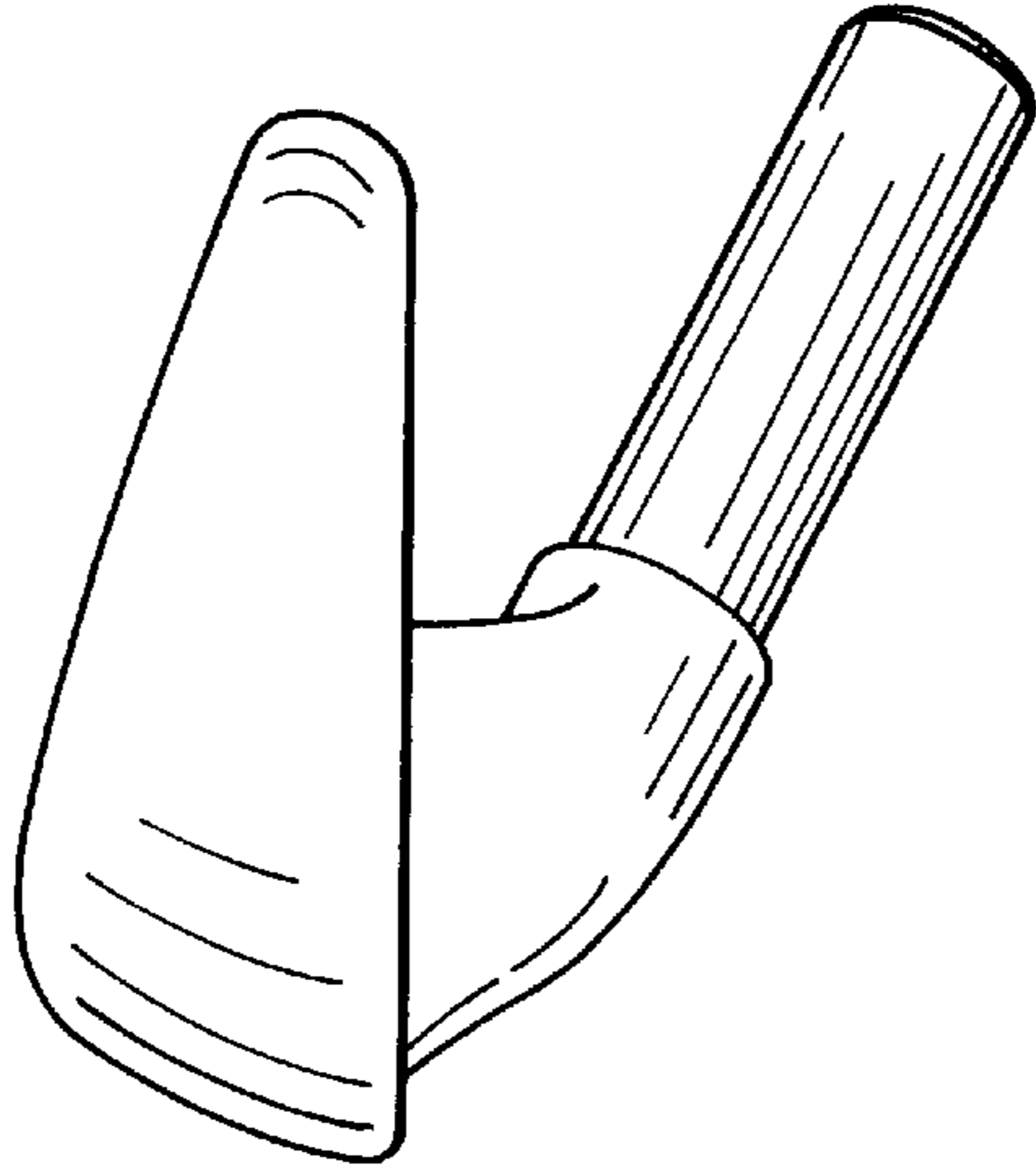

FIG. 14

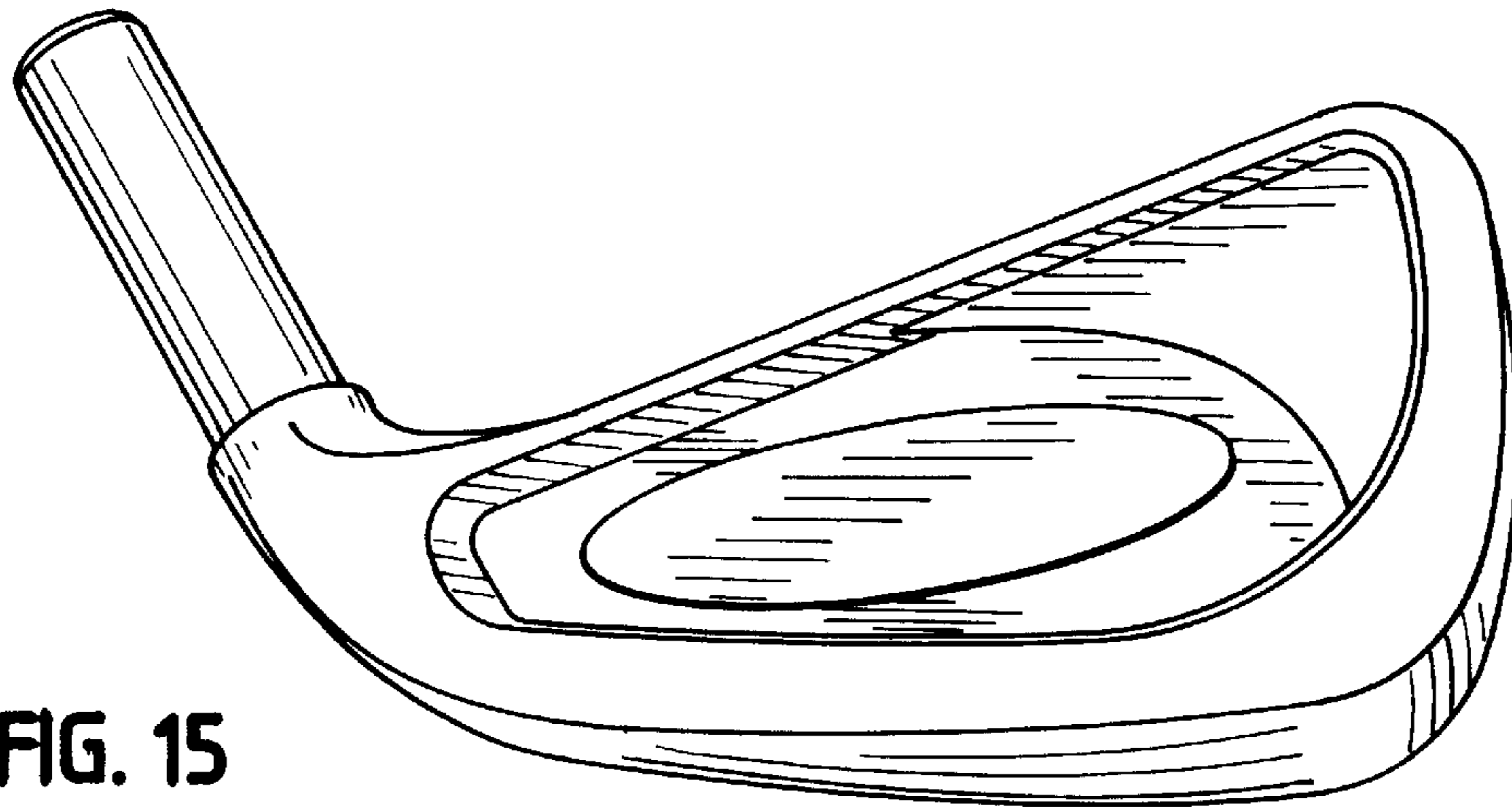
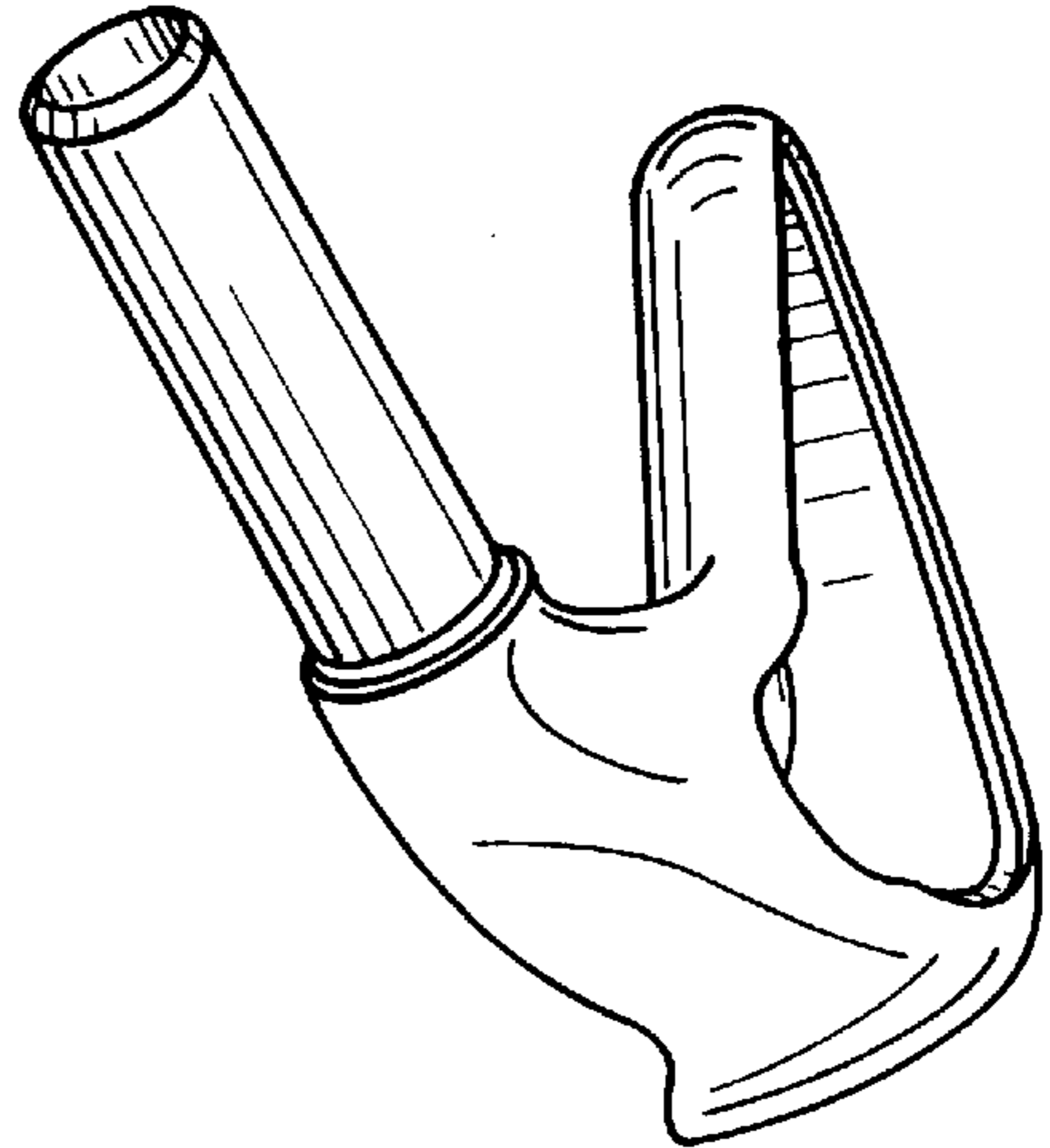

FIG. 15

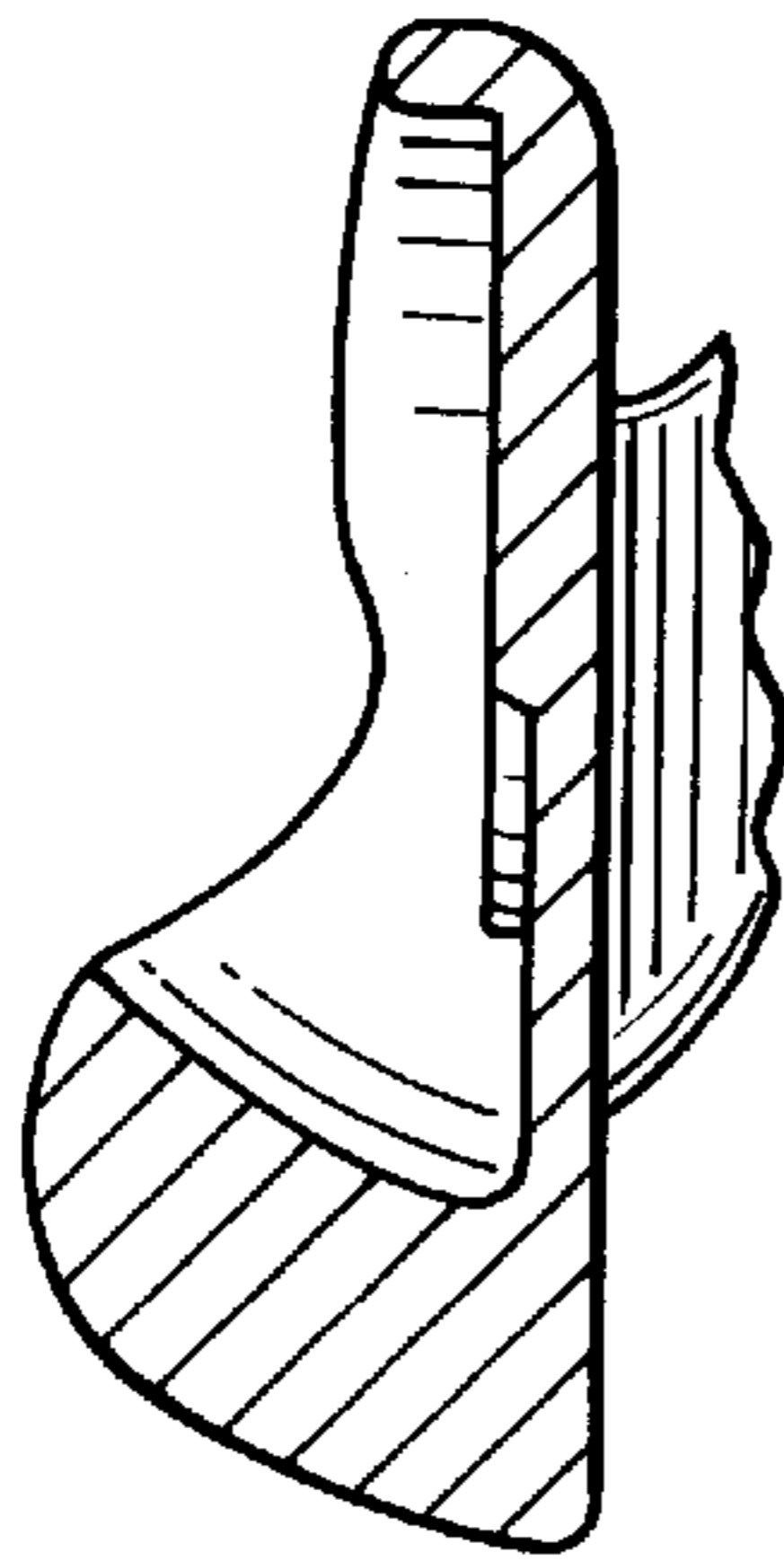

FIG. 16

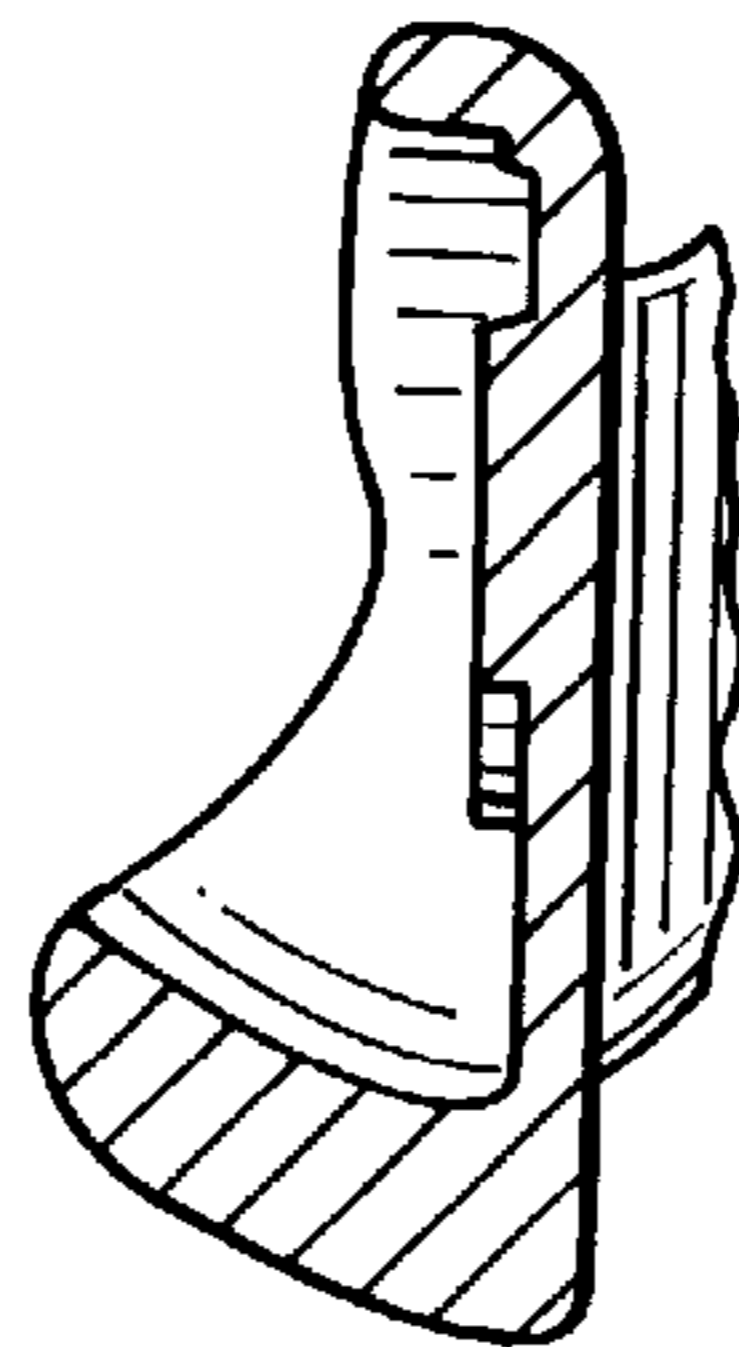

FIG. 17

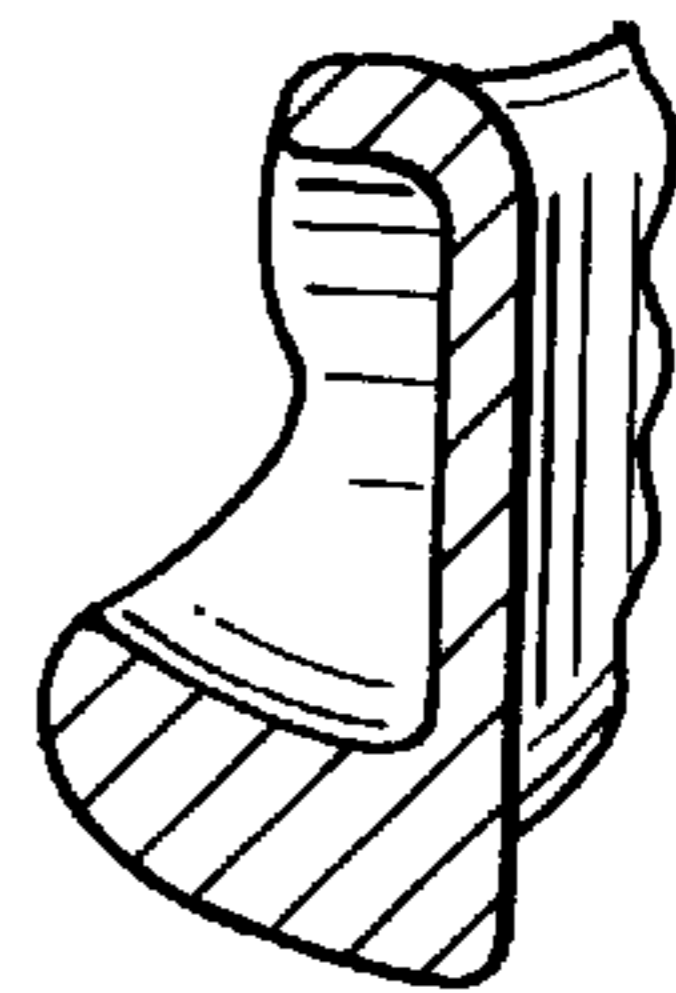

FIG. 18

FIG. 20

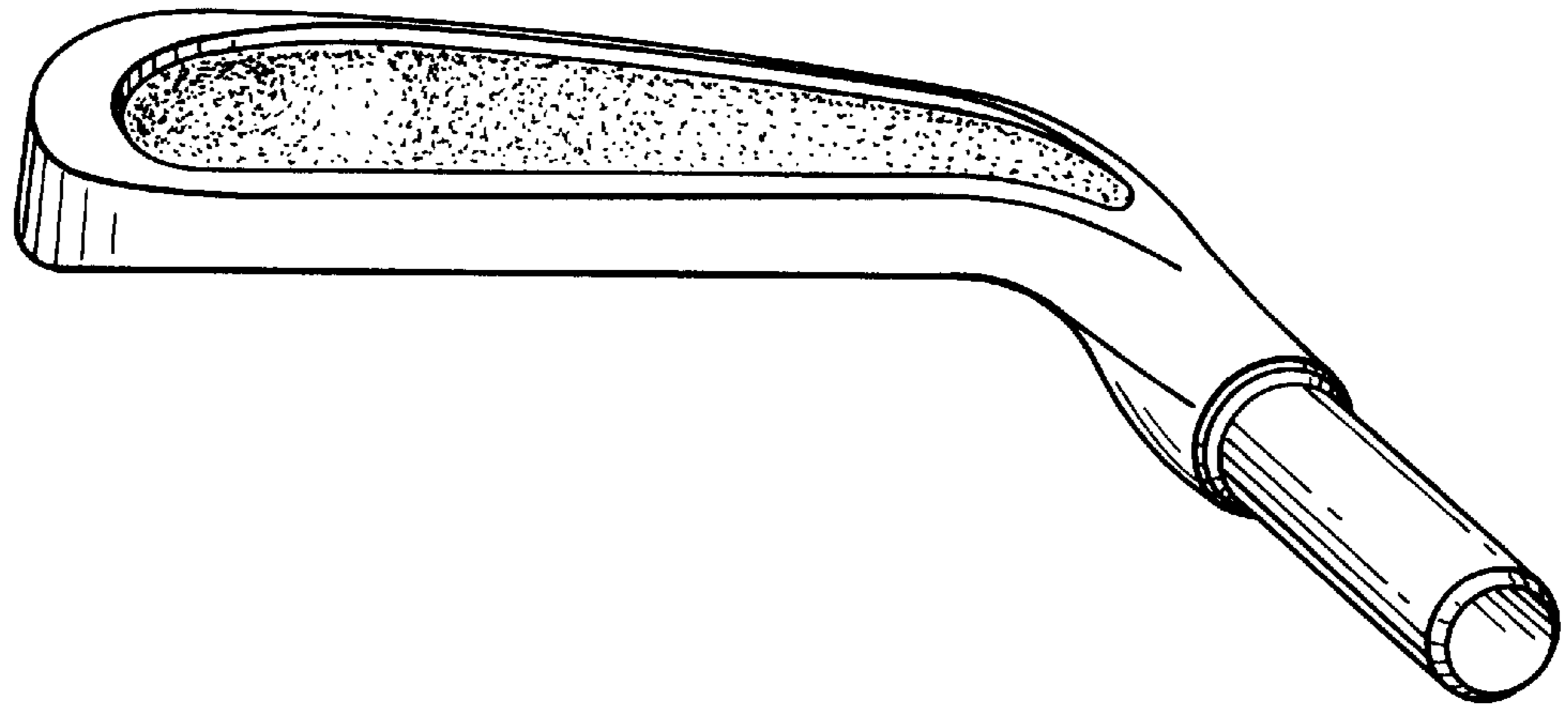

FIG. 19

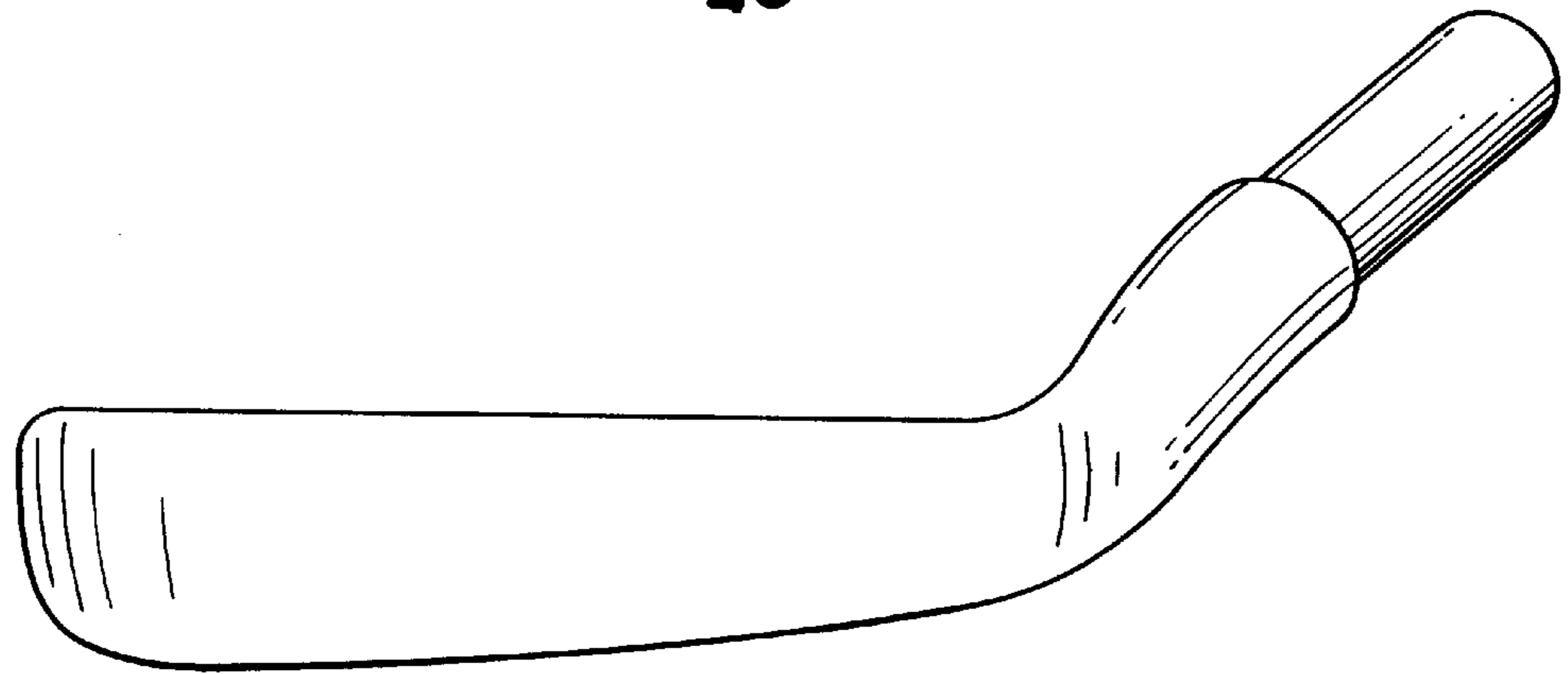
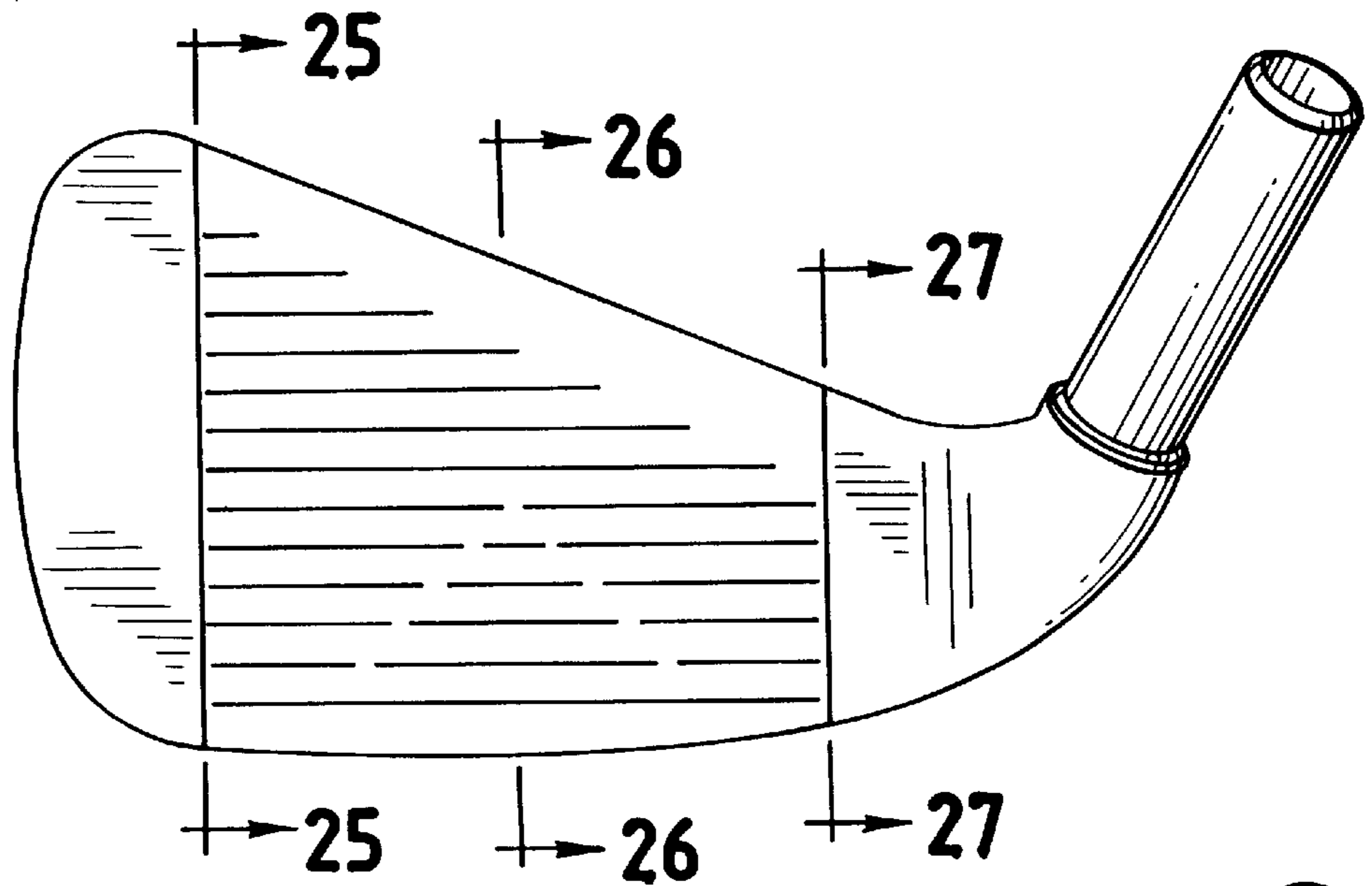

FIG. 21

FIG. 22

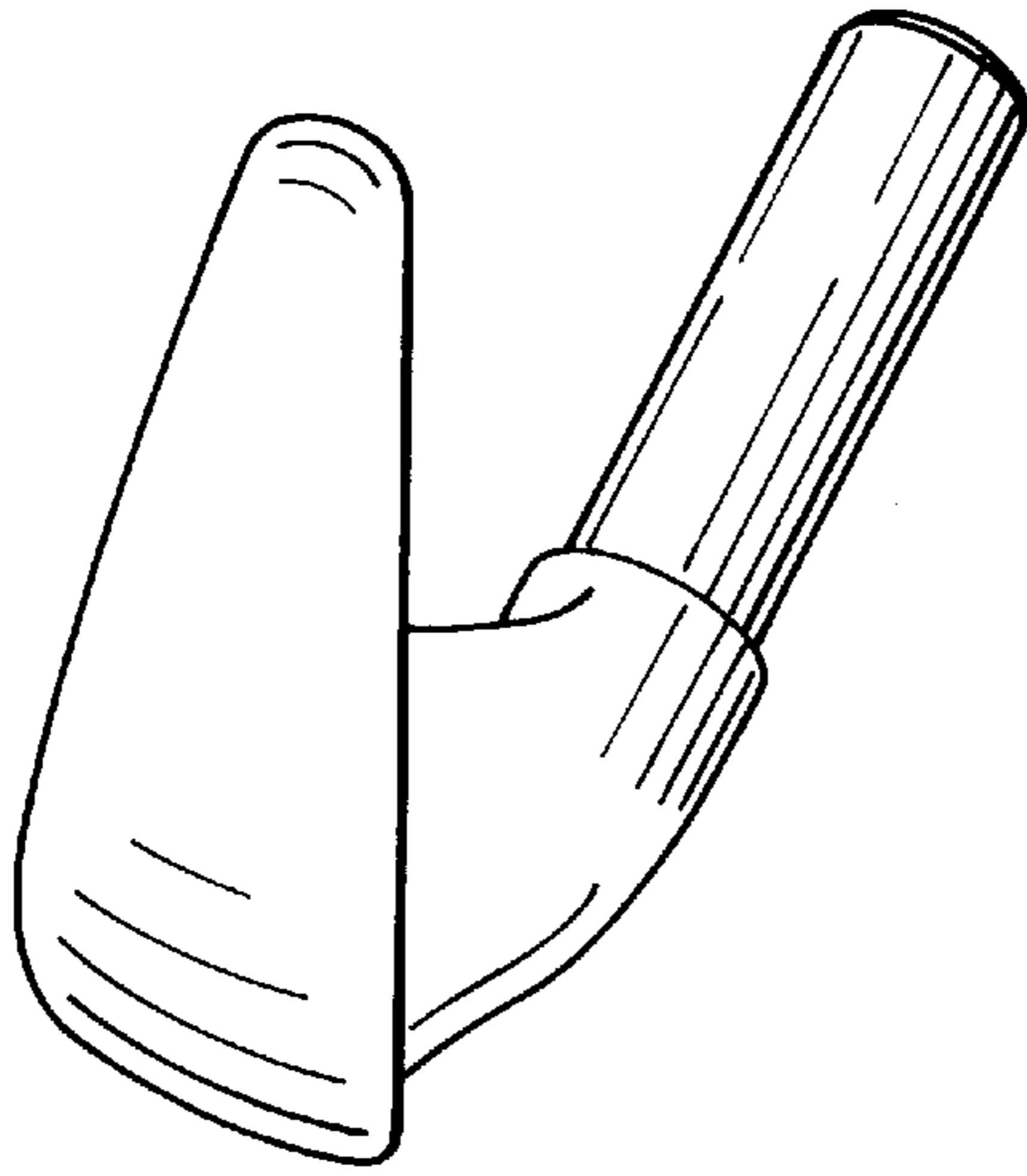

FIG. 23

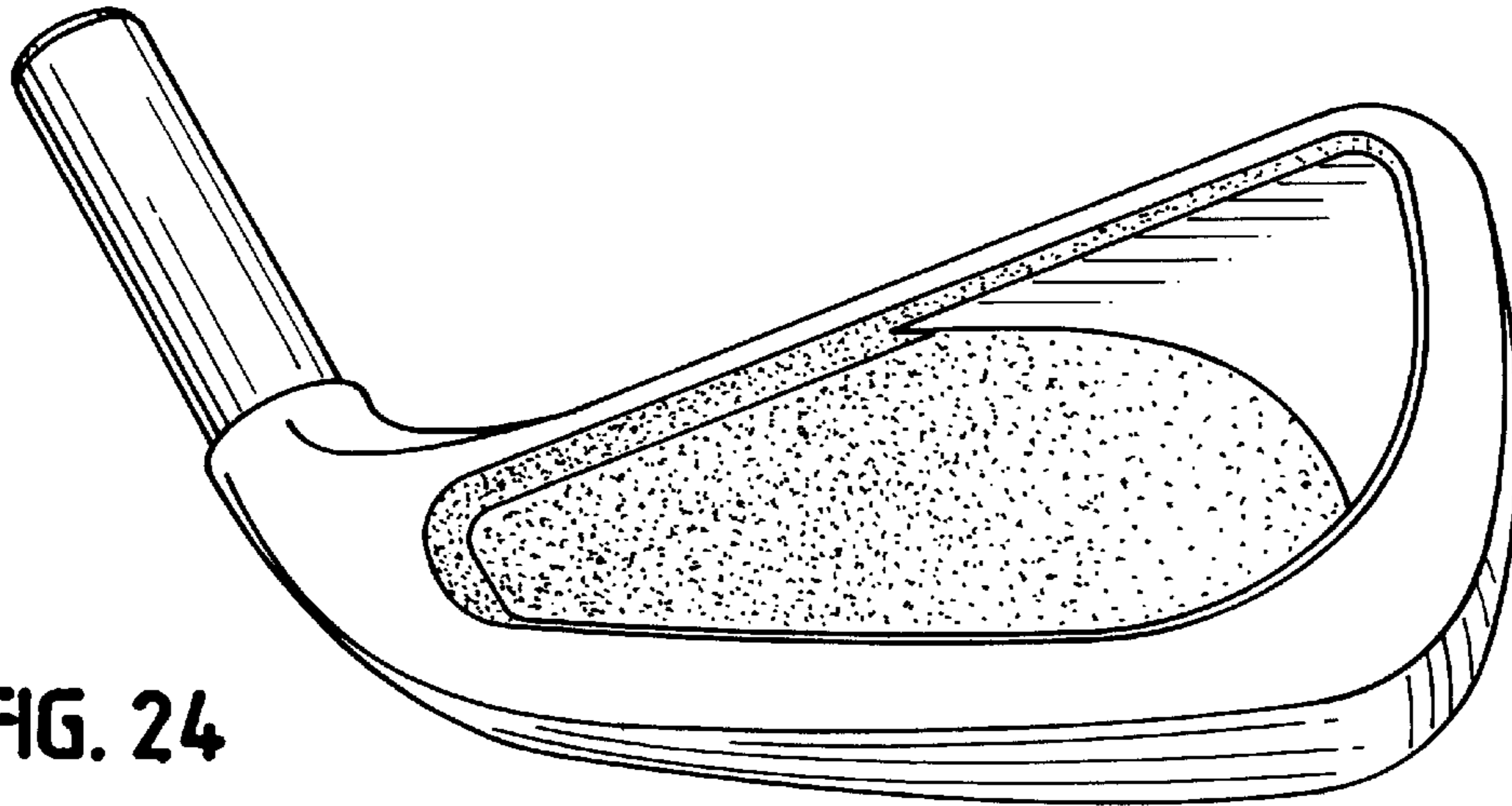
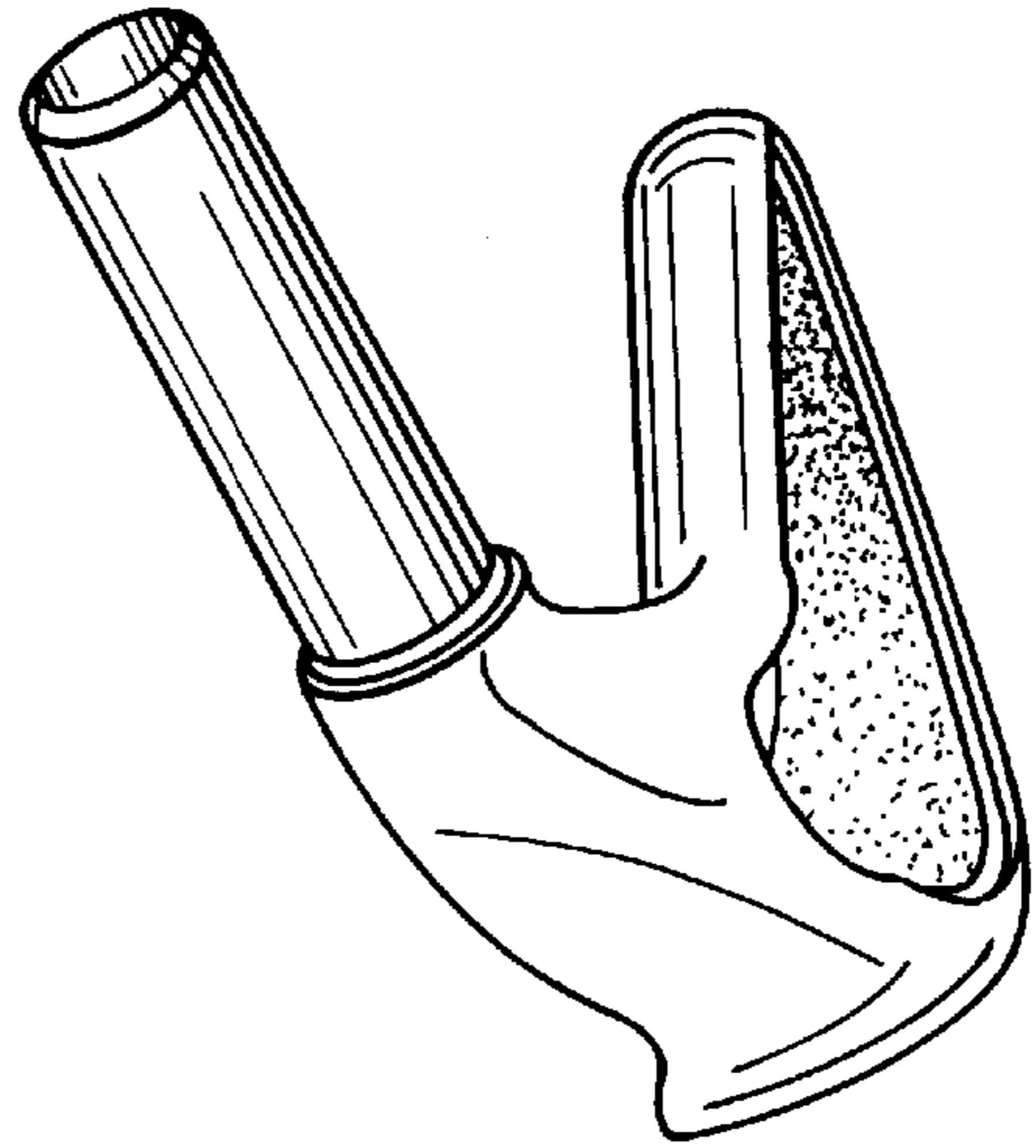

FIG. 24

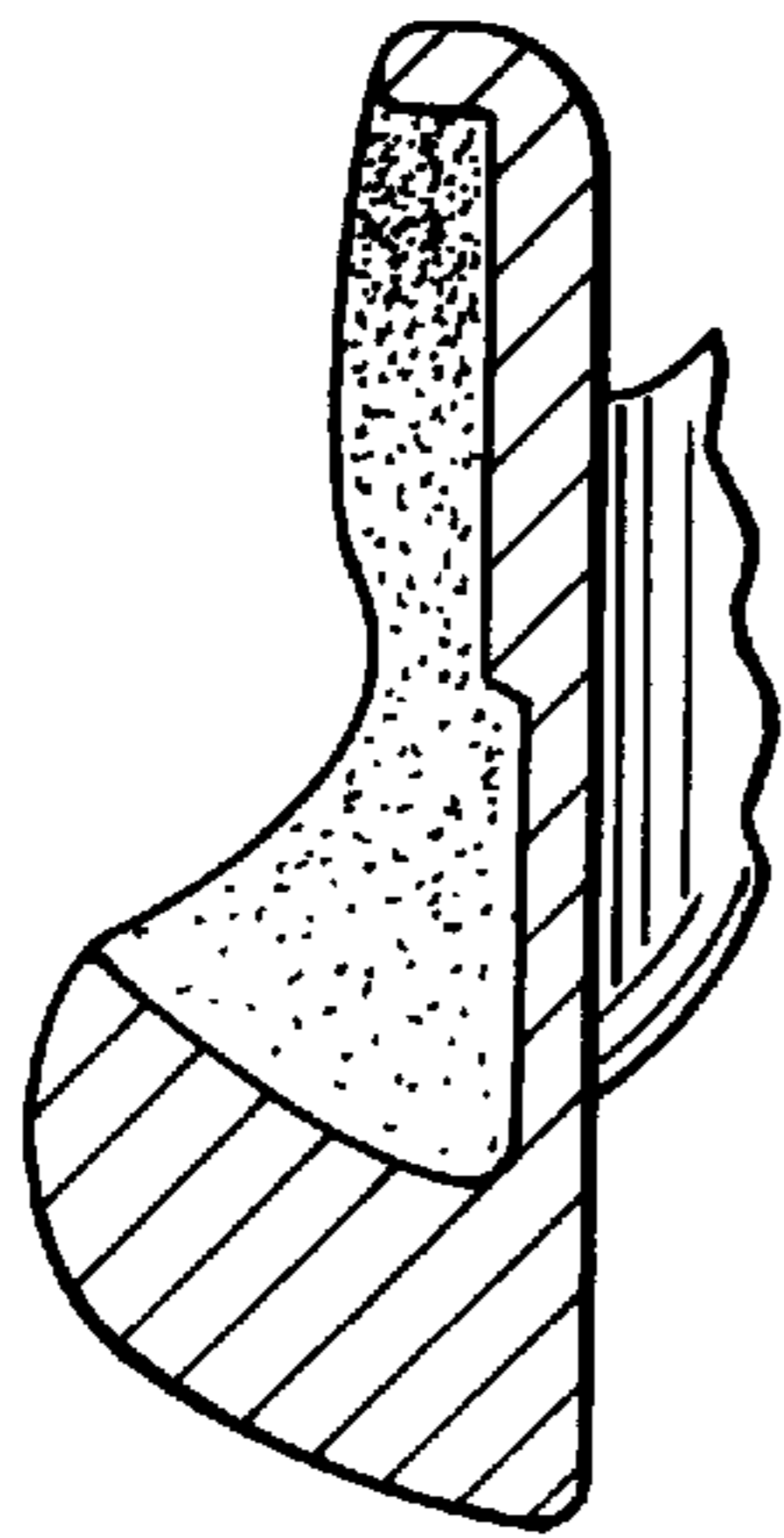

FIG. 25

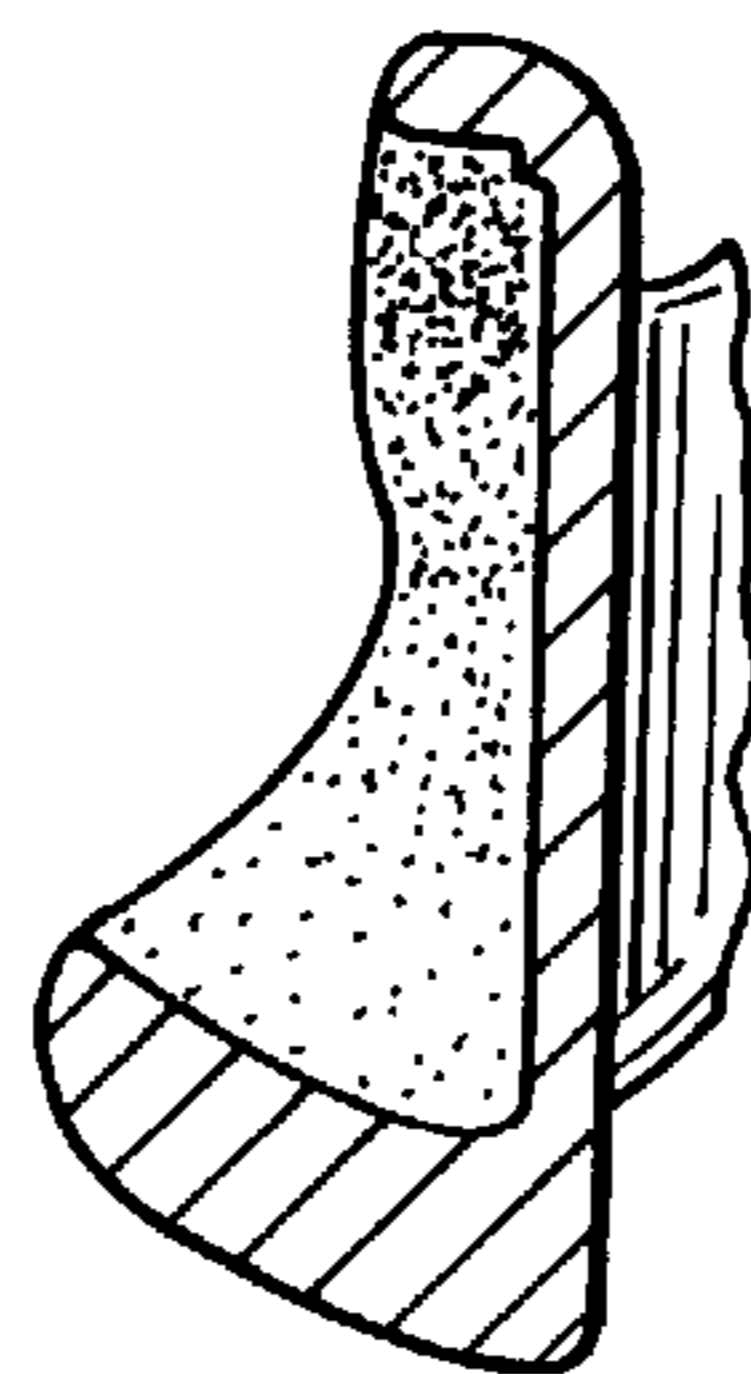

FIG. 26

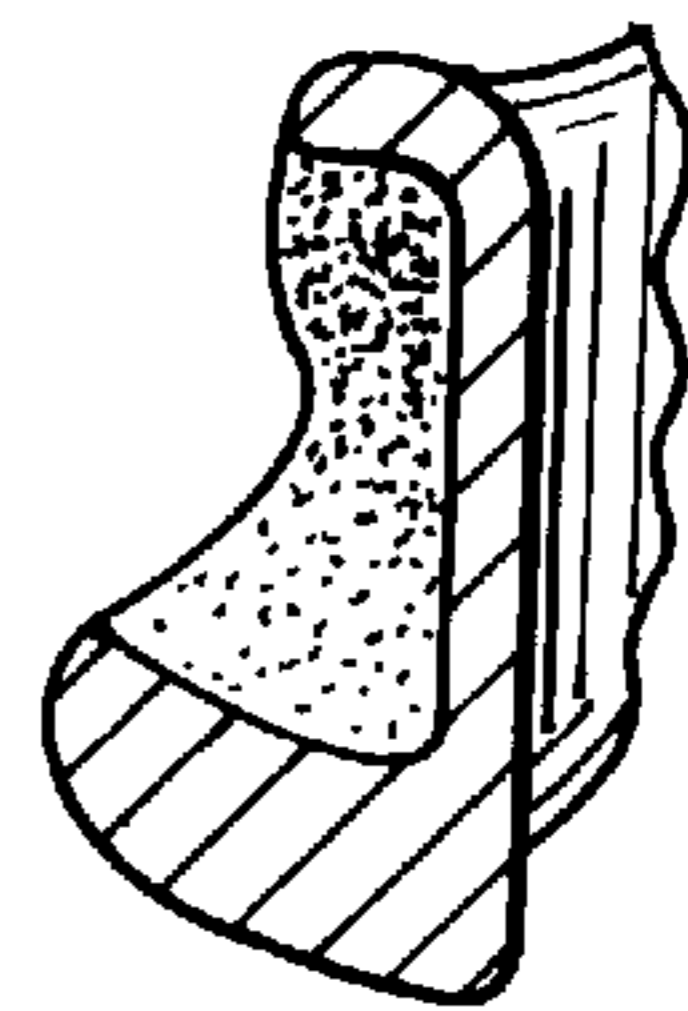

FIG. 27

FIG. 29

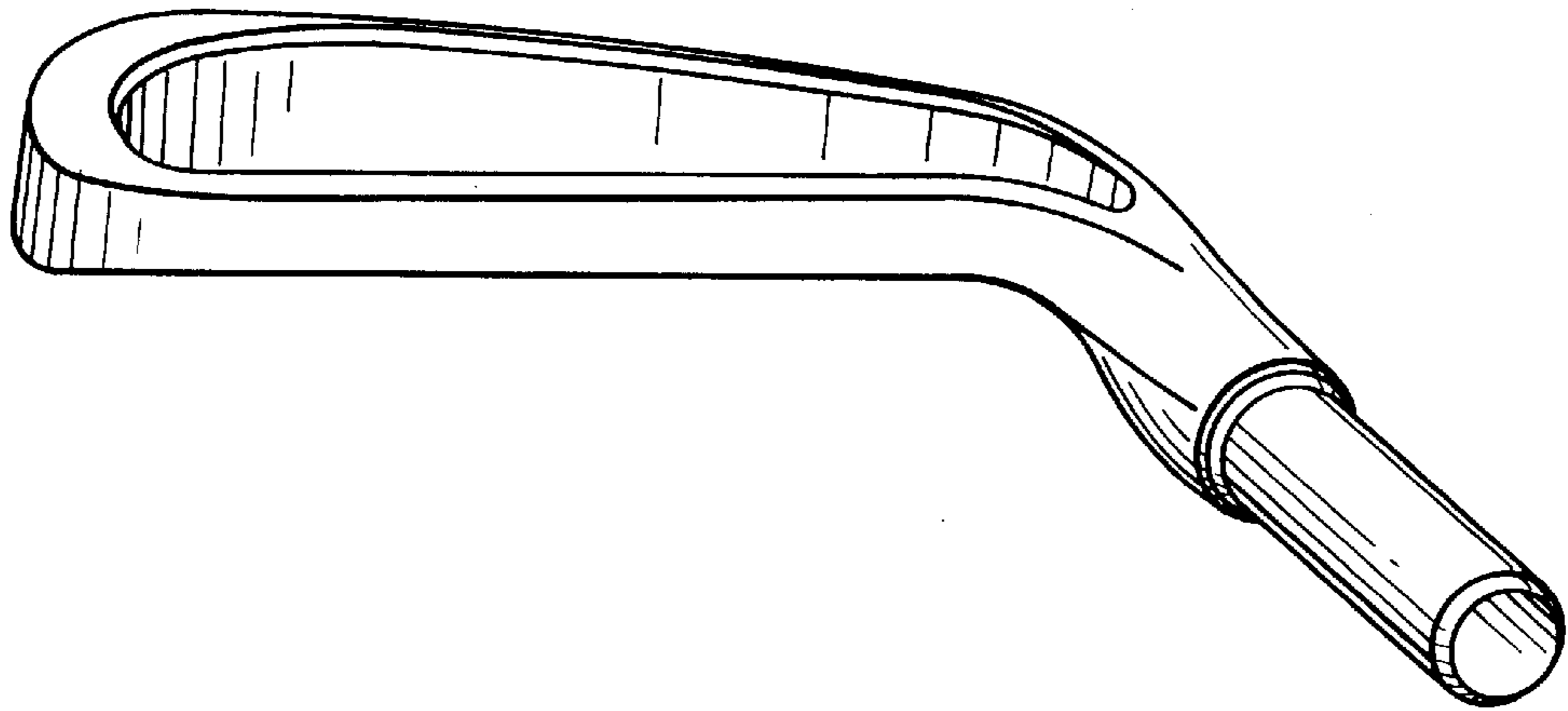

FIG. 28

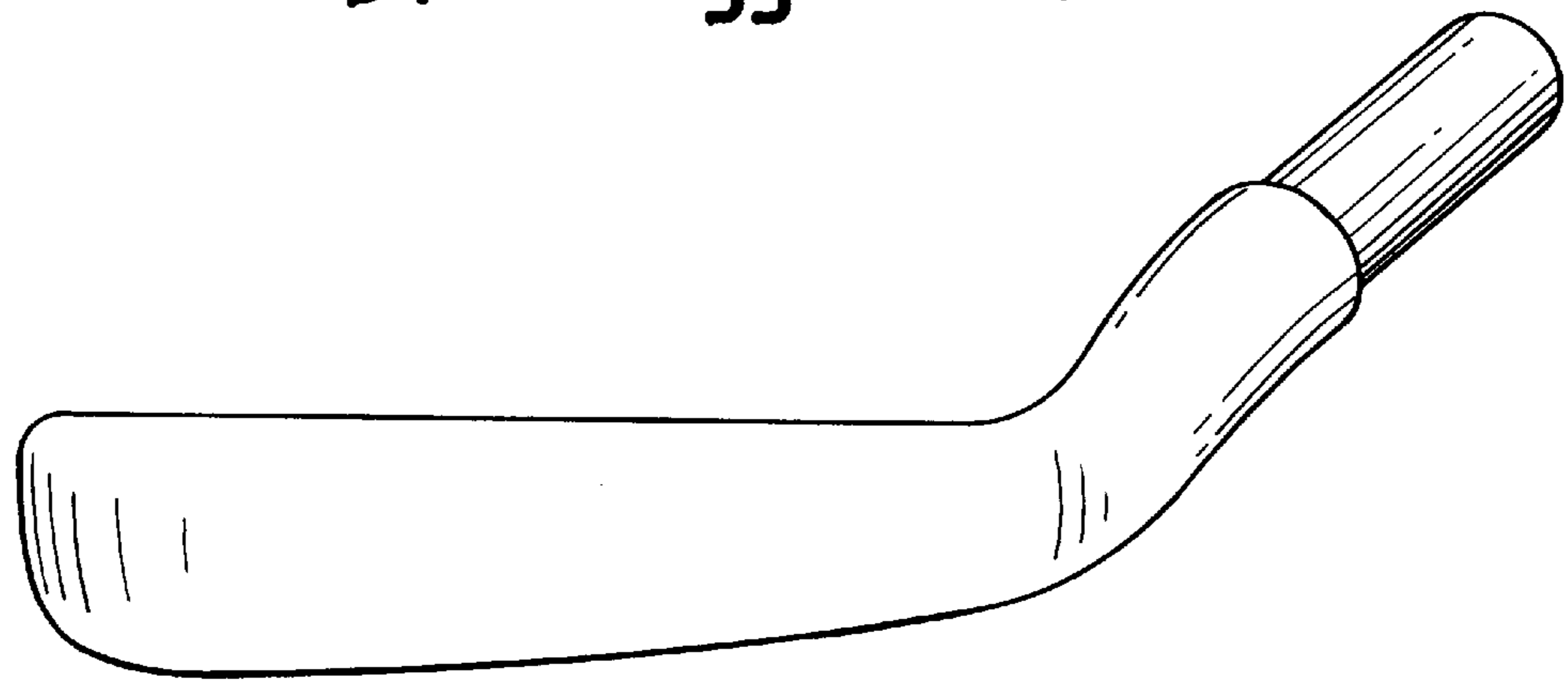
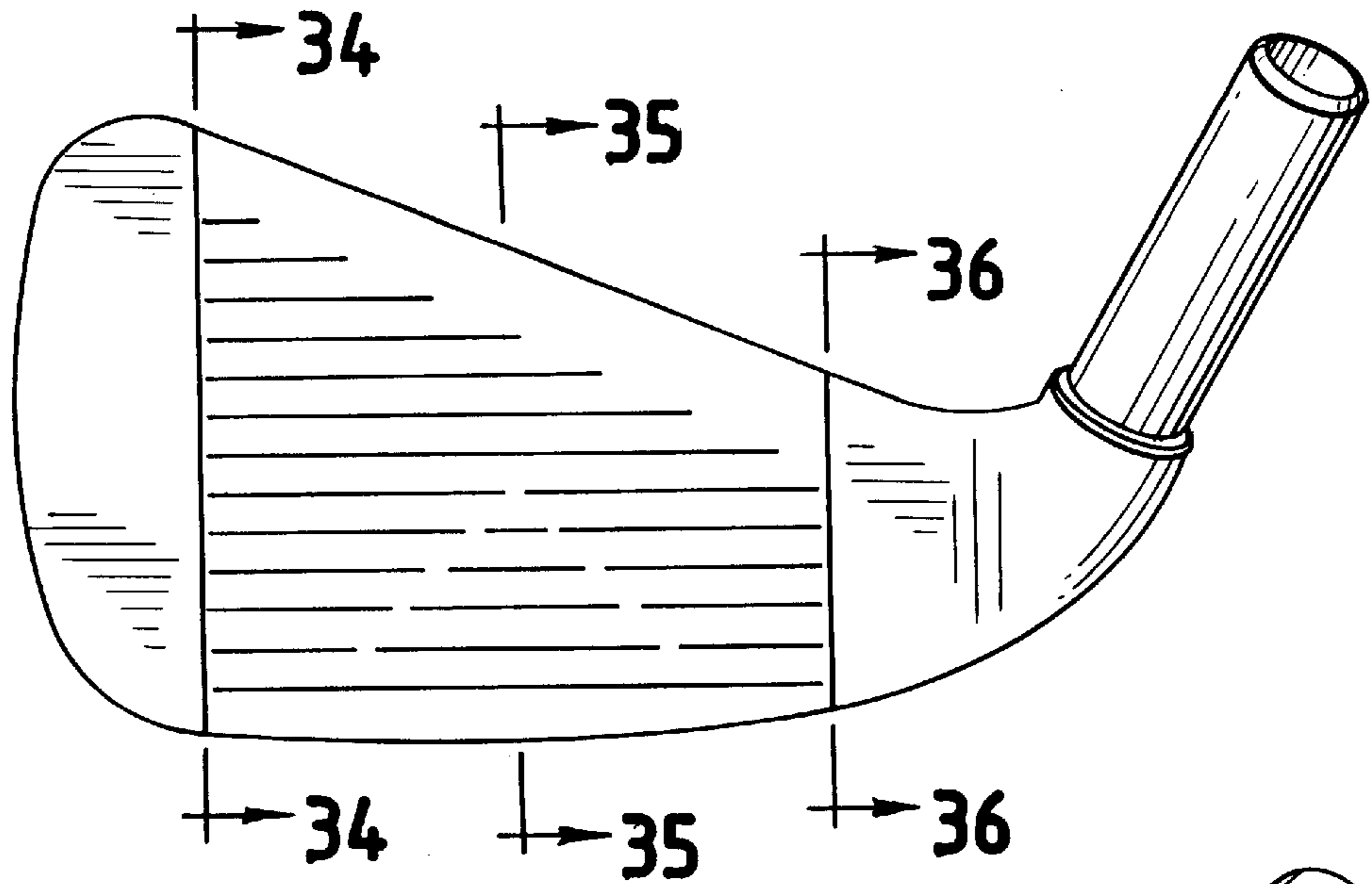

FIG. 30

FIG. 31

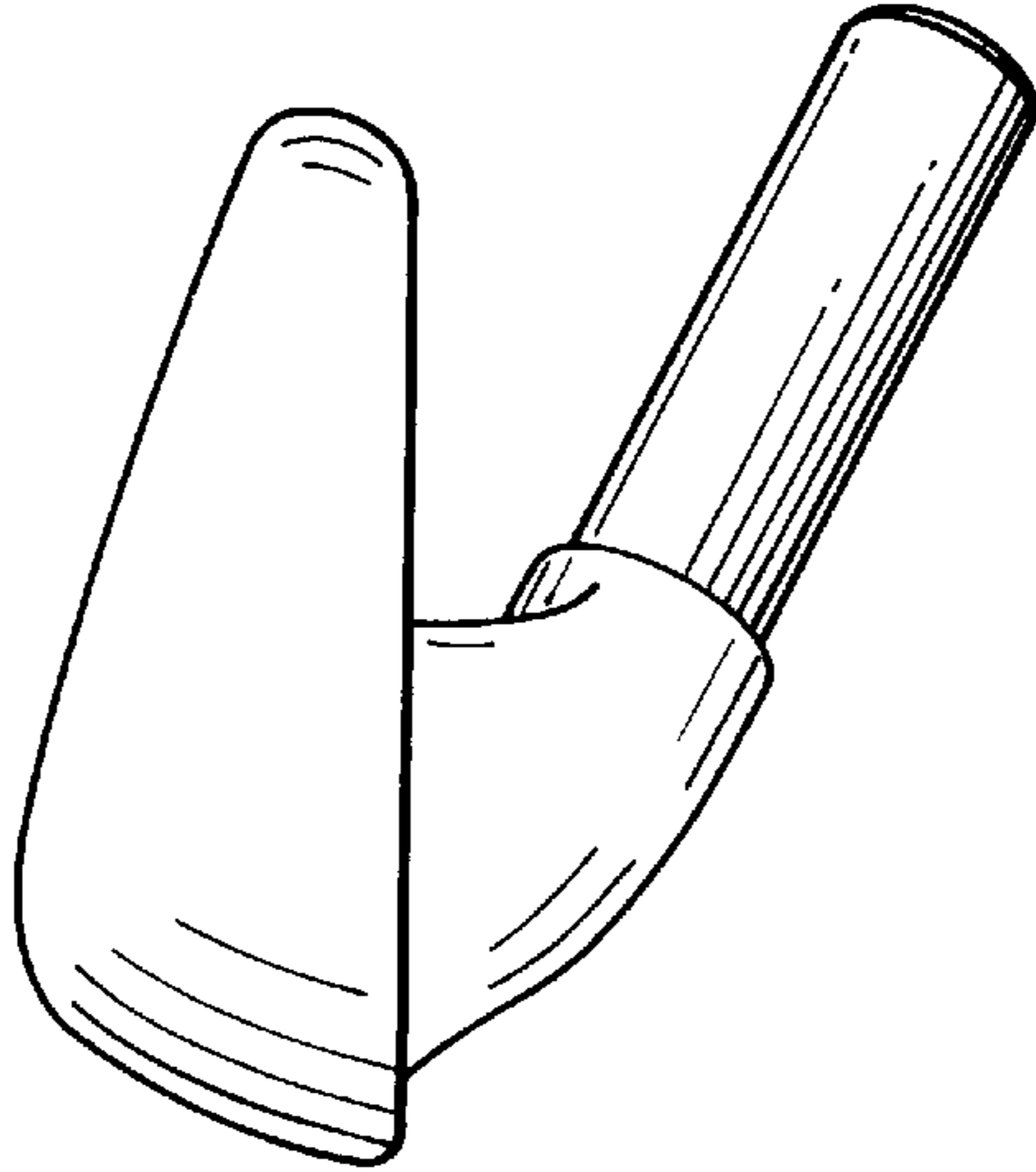

FIG. 32

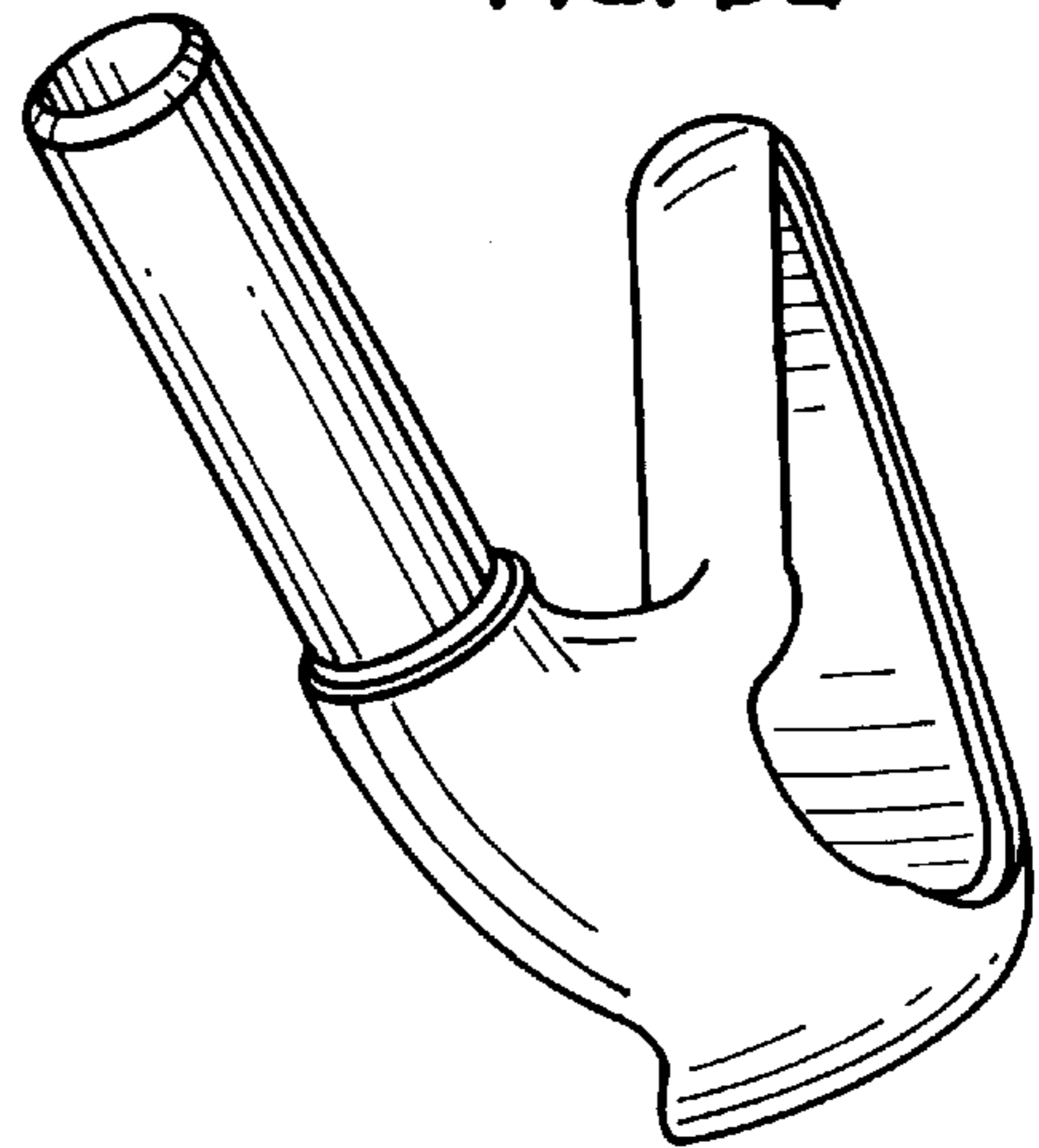

FIG. 33

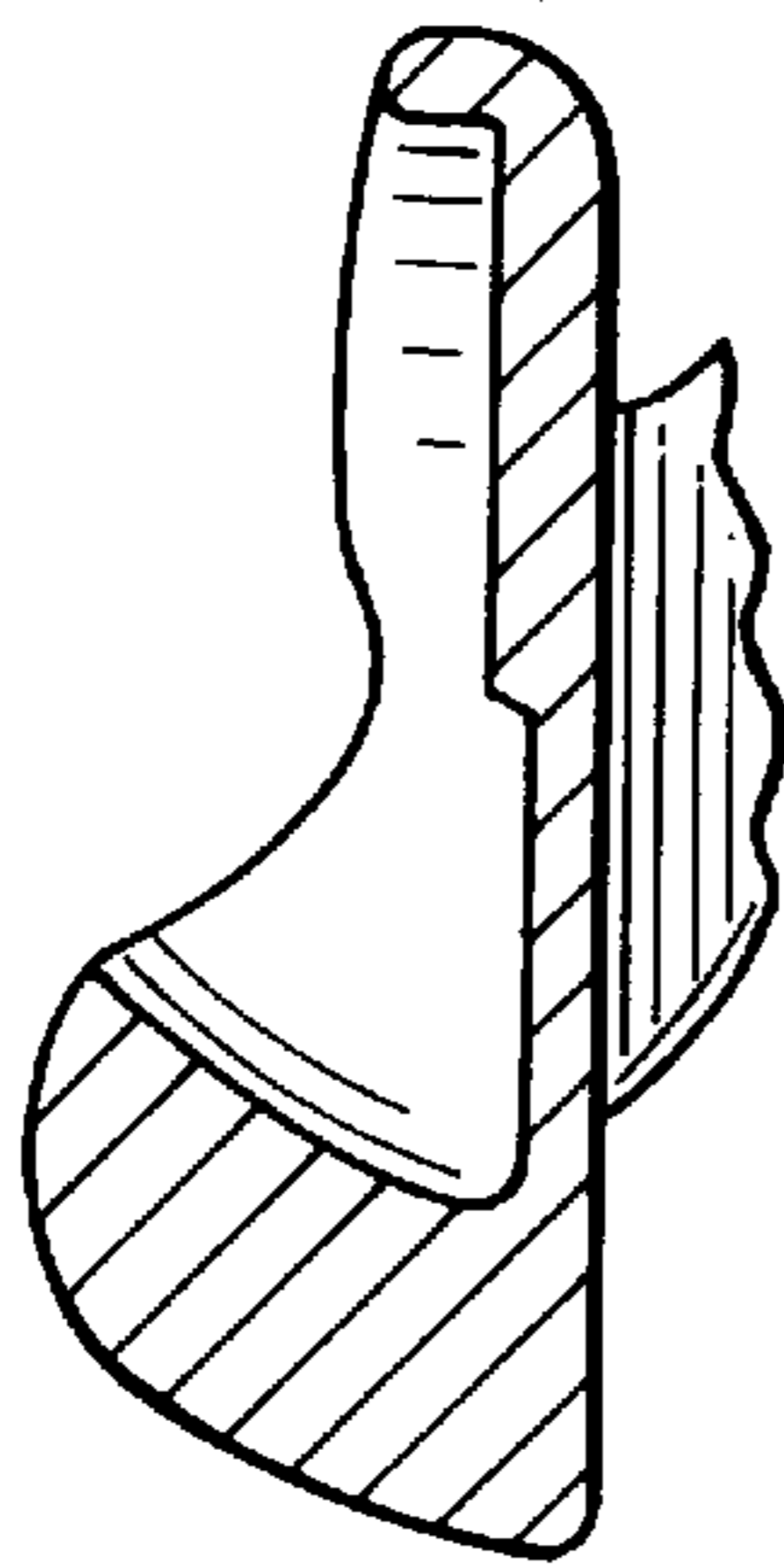

FIG. 34

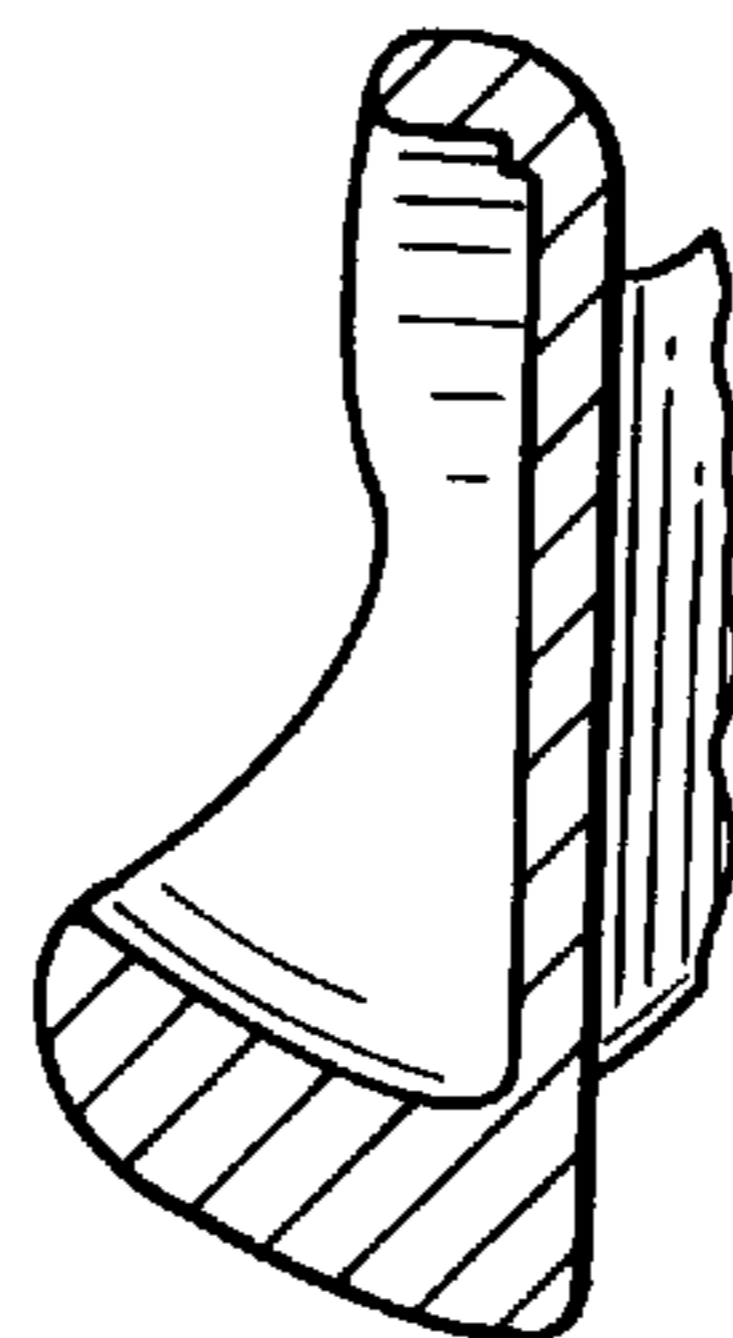

FIG. 35

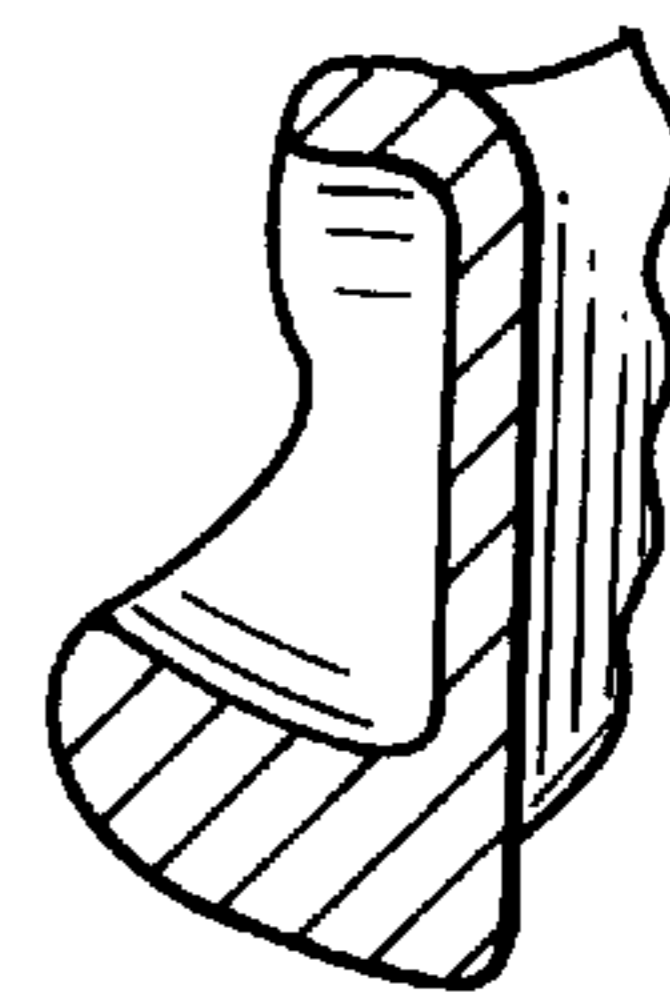

FIG. 36