



US00D404418S

United States Patent [19] Takeuchi

[11] **Patent Number: Des. 404,418**

[45] **Date of Patent: **Jan. 19, 1999**

[54] **PHOTOCOPIER**

D. 358,412 5/1995 Momose et al. D18/38 X

[75] Inventor: **Motoaki Takeuchi**, Tokyo, Japan

Primary Examiner—Caron D. Veynar
Attorney, Agent, or Firm—Fitzpatrick, Cella, Harper & Scinto

[73] Assignee: **Canon Kabushiki Kaisha**, Tokyo, Japan

[**] Term: **14 Years**

[57] **CLAIM**

[21] Appl. No.: **85,113**

The ornamental design for a photocopier, as shown and described.

[22] Filed: **Mar. 17, 1998**

DESCRIPTION

[30] **Foreign Application Priority Data**

FIG. 1 is a front view of a photocopier showing my new design;
FIG. 2 is a rear view thereof;
FIG. 3 is a top plan view thereof;
FIG. 4 is a bottom plan view thereof;
FIG. 5 is a left side view thereof;
FIG. 6 is a right side view thereof; and,
FIG. 7 is a perspective view thereof.

Sep. 22, 1997 [JP] Japan 9-68695

[51] **LOC (6) Cl.** **16-03**

[52] **U.S. Cl.** **D18/39**

[58] **Field of Search** D18/36-39; 399/1-7,
399/161, 130

[56] **References Cited**

U.S. PATENT DOCUMENTS

D. 320,409 10/1991 Kosako et al. D18/39

1 Claim, 7 Drawing Sheets

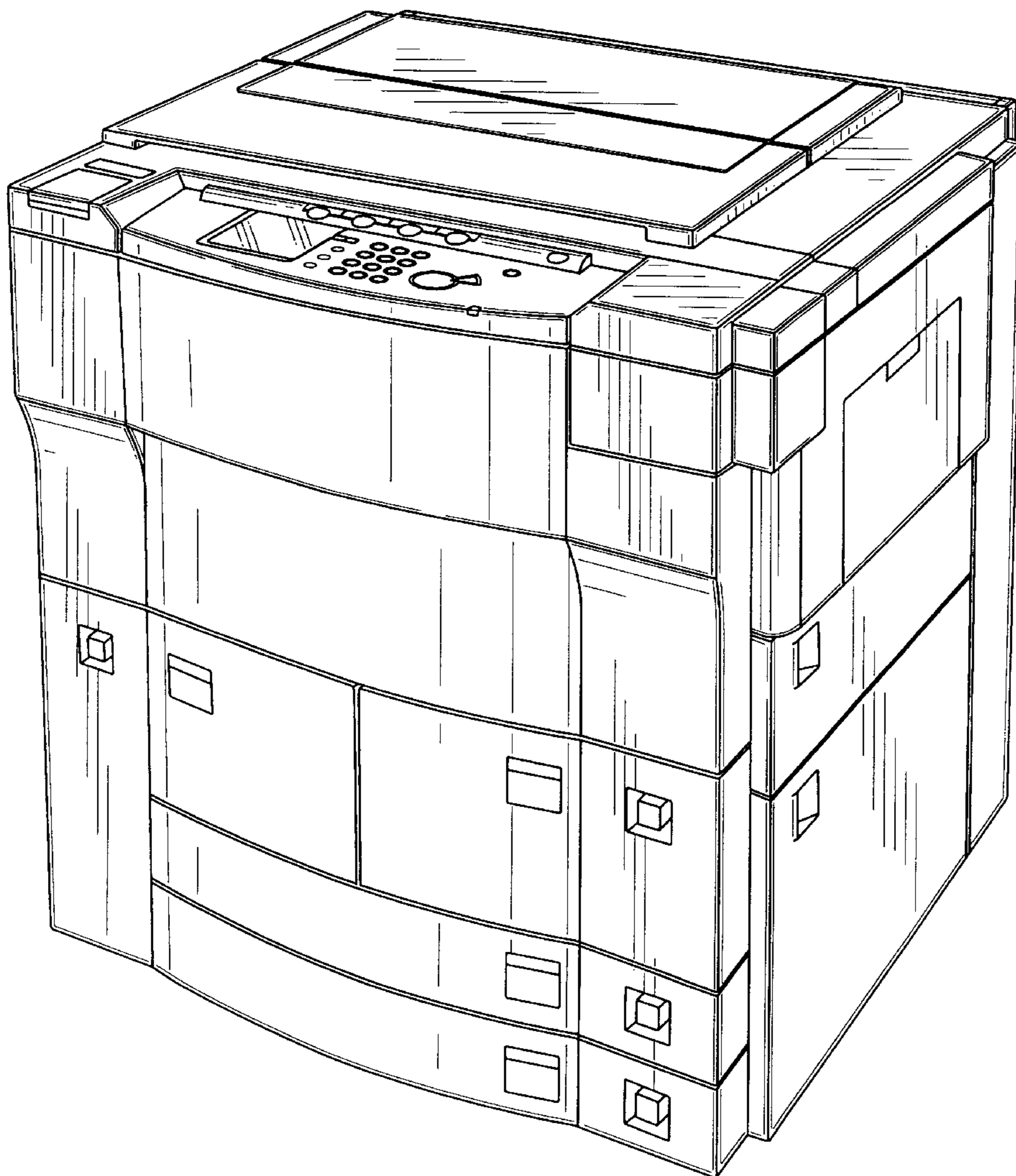

FIG. 1

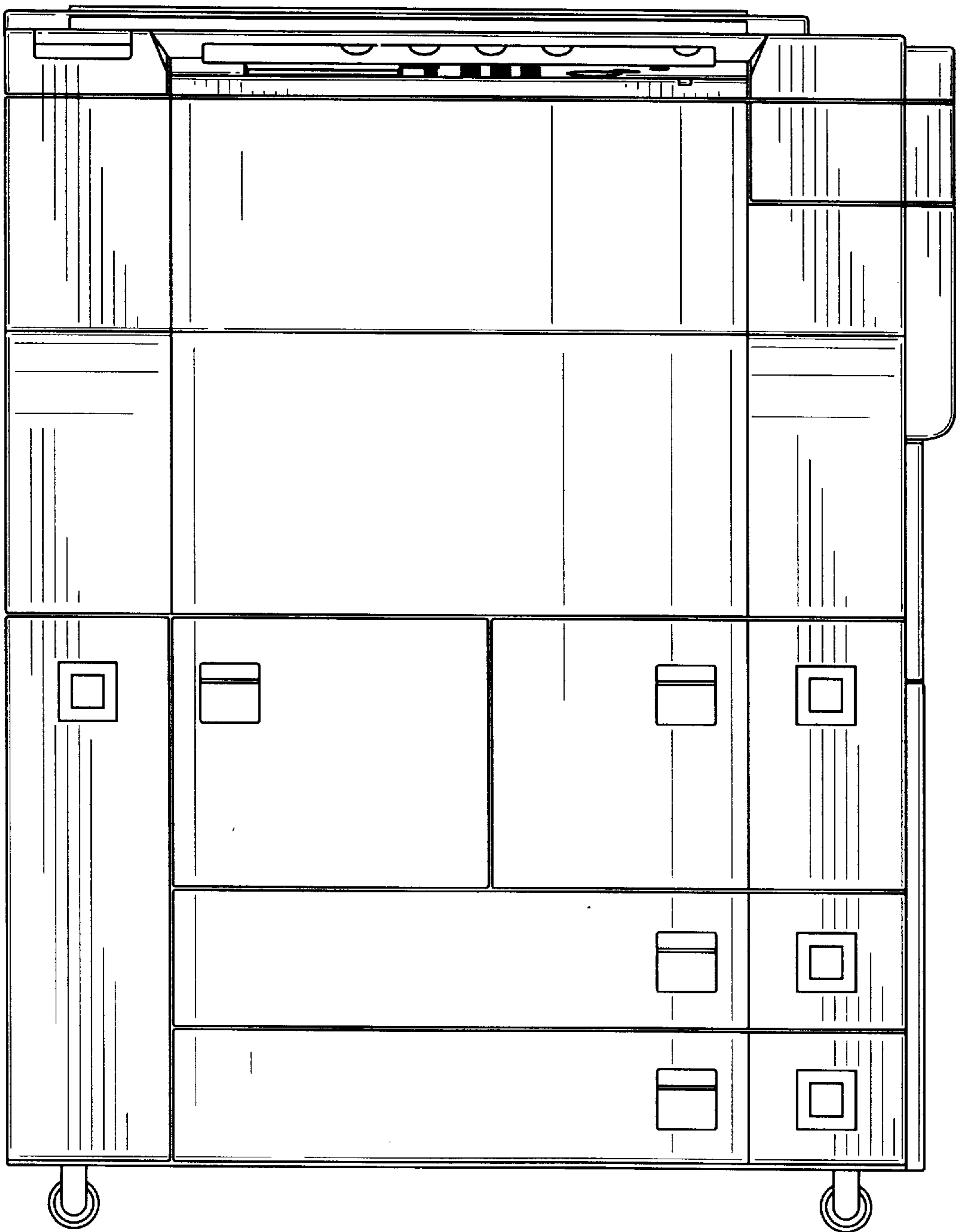

FIG. 2

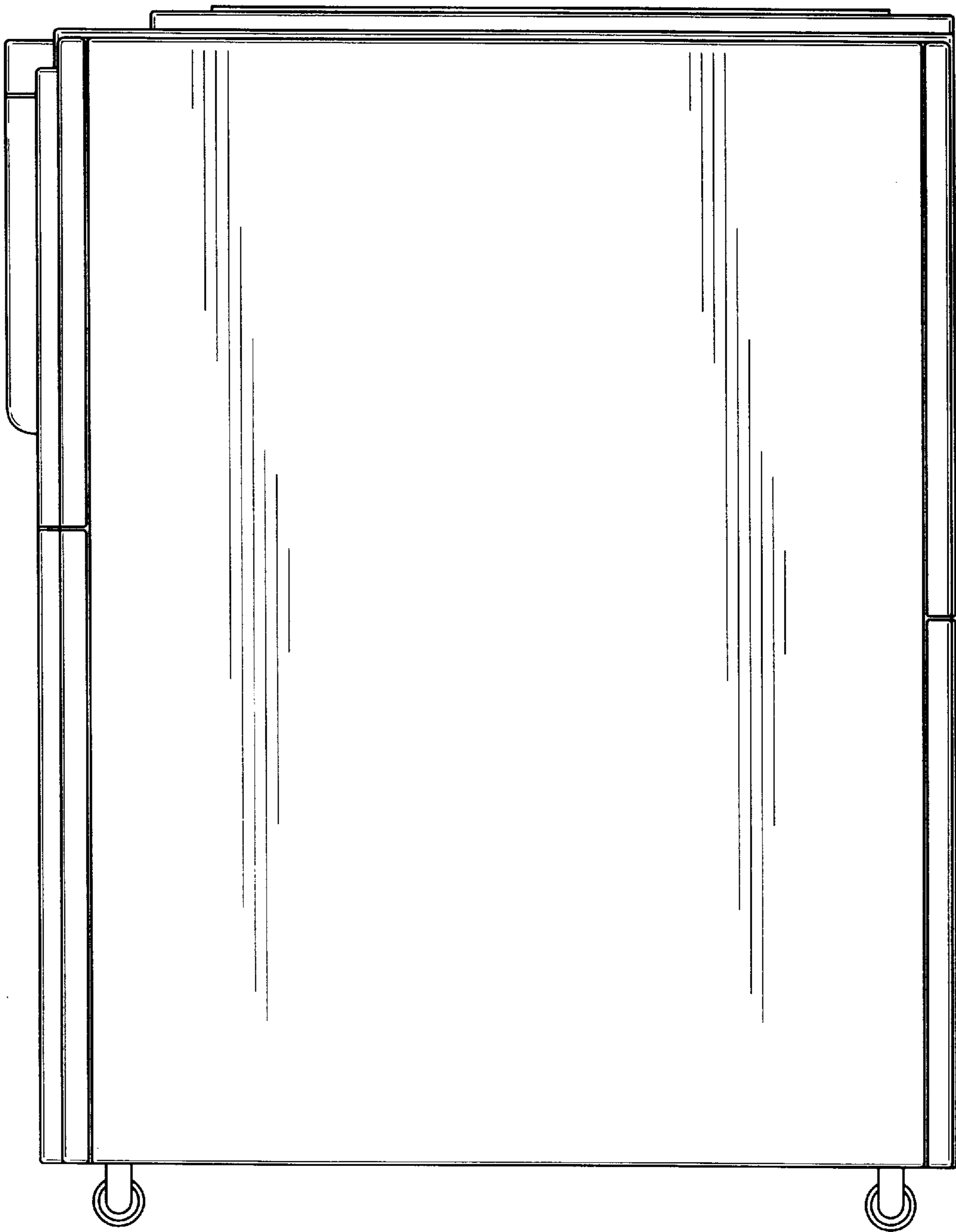

FIG. 3

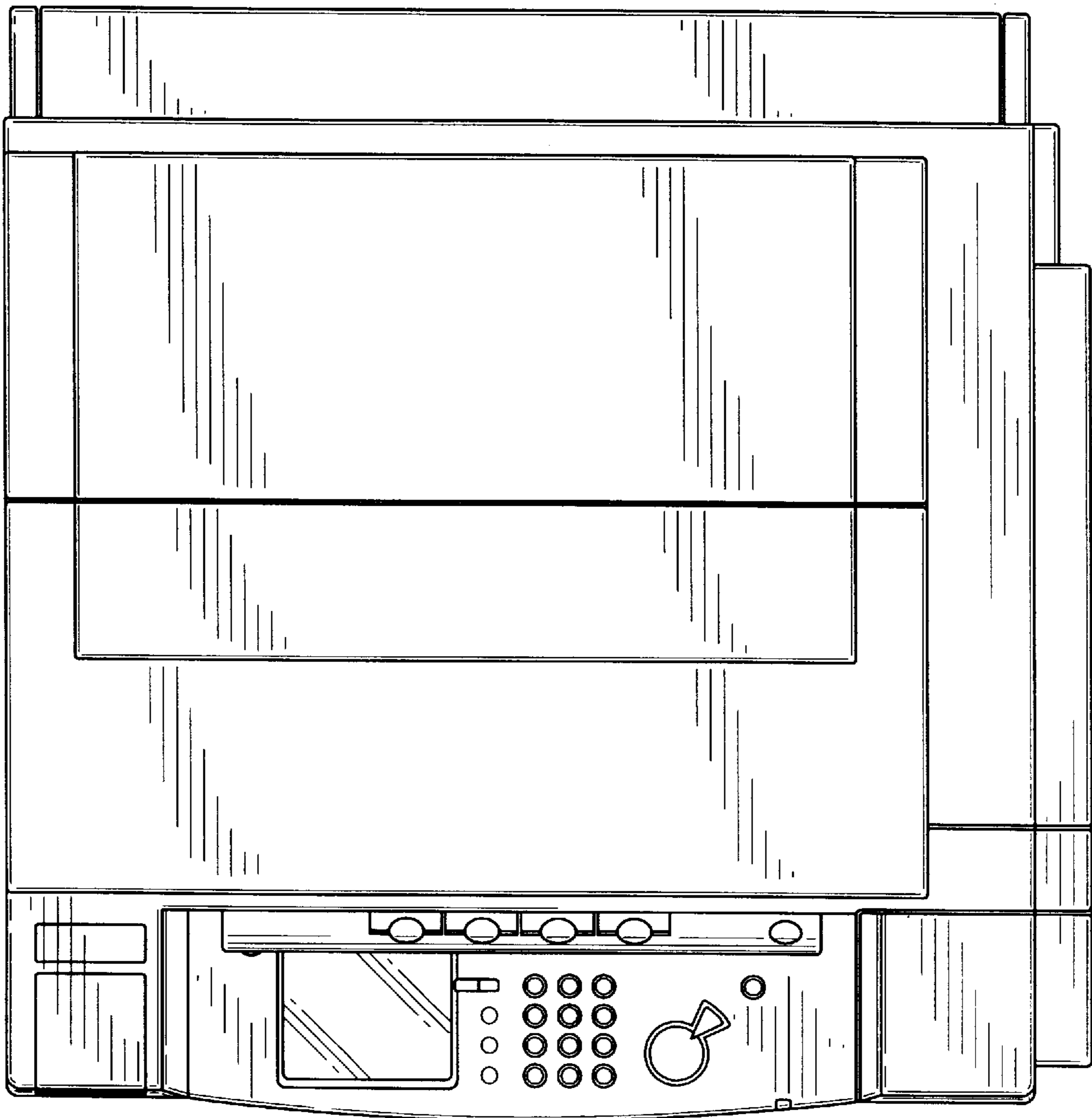

FIG. 4

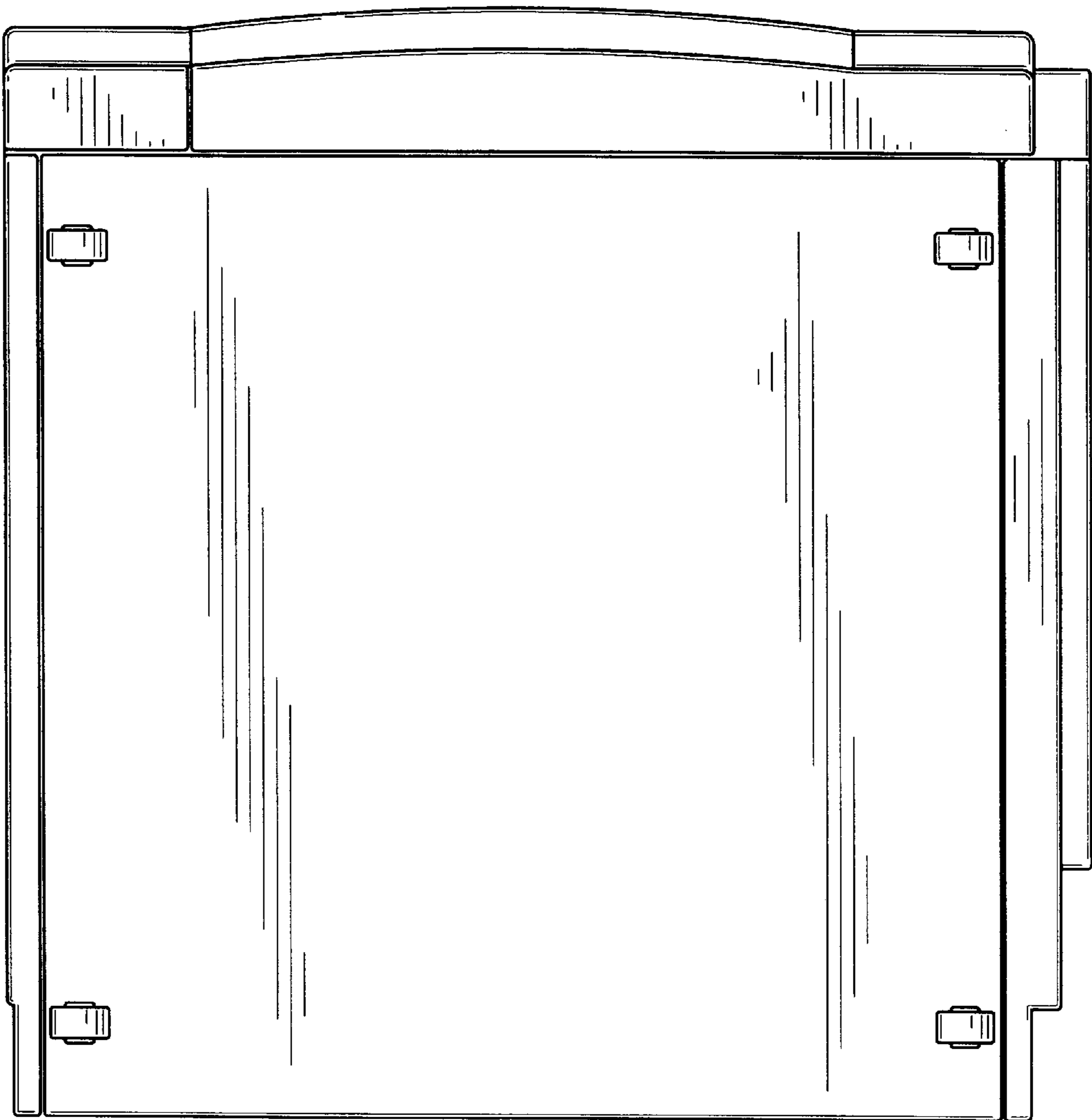

FIG. 5

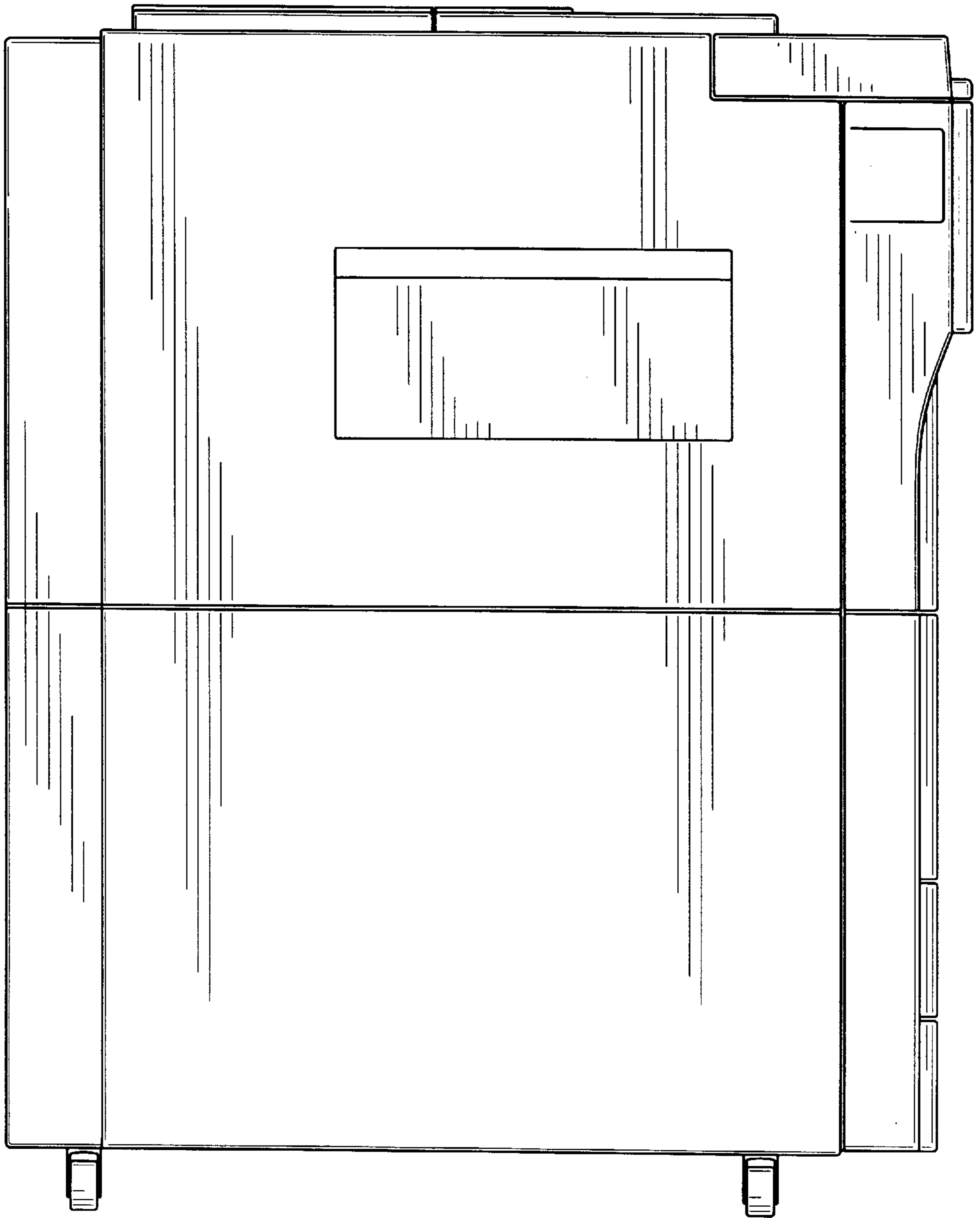

FIG. 6

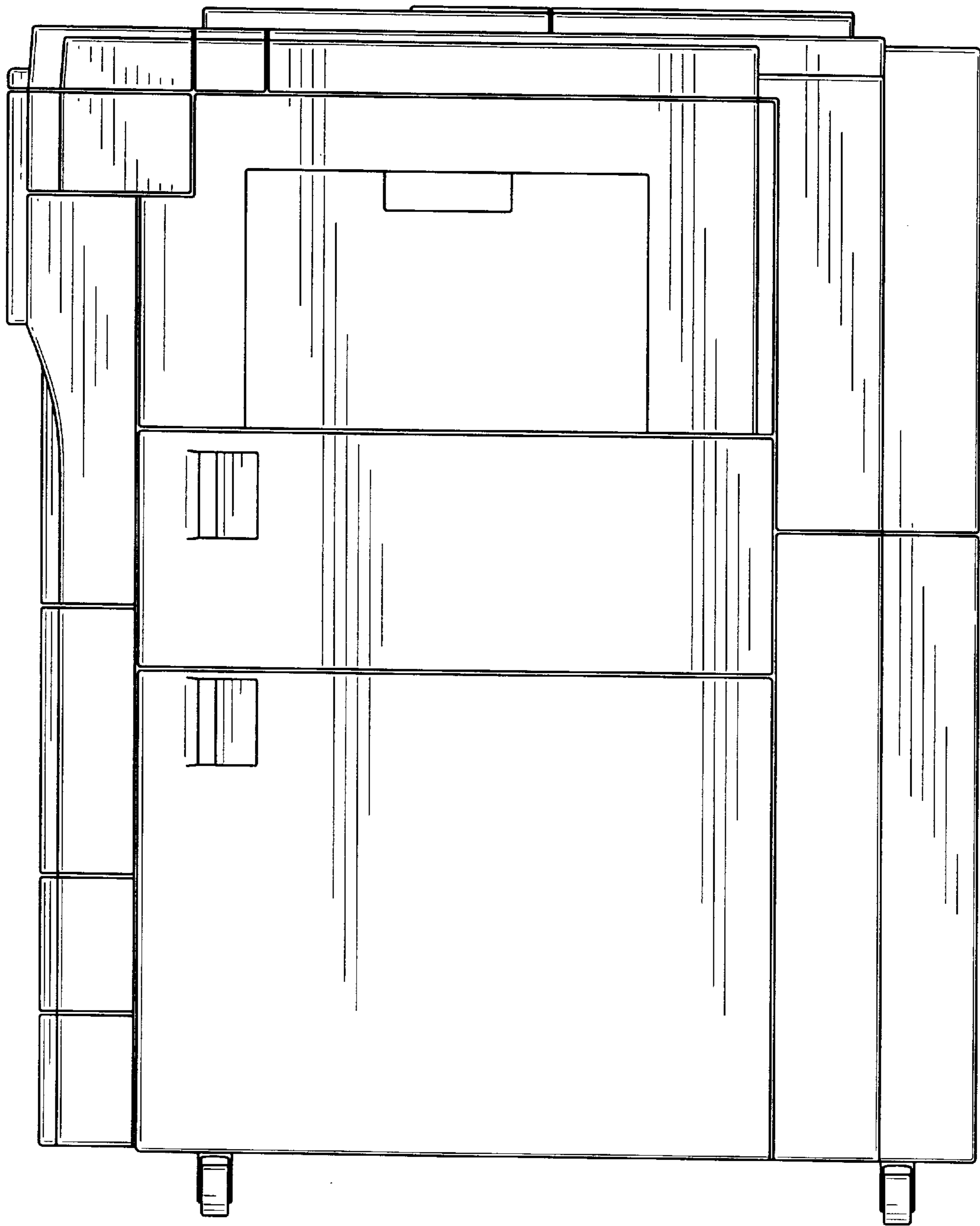

FIG. 7

