



US00D404407S

United States Patent [19]

[11] **Patent Number: Des. 404,407**

Arfele et al.

[45] **Date of Patent: **Jan. 19, 1999**

[54] **EIGHT BLADE DRILL BIT**

[75] Inventors: **Robert W. Arfele; George A. Espiritu,** both of Houston; **Ed R. Martin, Jr.,** Spring, all of Tex.

[73] Assignee: **Dresser Industries, Inc.,** Dallas, Tex.

[**] Term: **14 Years**

[21] Appl. No.: **84,561**

[22] Filed: **Mar. 5, 1998**

[51] **LOC (6) Cl. 15-09**

[52] **U.S. Cl. D15/139**

[58] **Field of Search** D15/139; 175/379, 175/385, 393, 418, 420.1, 421, 427, 430-432; 299/29

[56] **References Cited**

U.S. PATENT DOCUMENTS

D. 340,248	10/1993	Brady	D15/139
D. 351,174	10/1994	Brady	D15/139
4,373,593	2/1983	Phaal et al.	.	
5,007,493	4/1991	Coolidge et al.	175/421 X
5,111,895	5/1992	Griffin	.	
5,159,857	11/1992	Jurewicz	.	
5,443,565	8/1995	Strange, Jr.	.	
5,549,171	8/1996	Mensa-Wilmot et al.	.	
5,551,522	9/1996	Keith et al.	175/420.2
5,582,261	12/1996	Keith et al.	175/431
5,651,421	7/1997	Newton et al.	.	

OTHER PUBLICATIONS

Catalogue/Brochure pages: "DP6 PDC Drill Bit." Admitted prior art.

Catalogue/Brochure pages: "Diamond Drill Bits." Cristal Profor. Tarbes, France. Admitted prior art.

Catalogue/Brochure pages: "A Strong Line of Natural Diamond and PDC Bits." Smith Diamond. Admitted prior art.

Catalogue/Brochure pages: IADC S946, et al. Smith Diamond. Admitted prior art.

Catalogue/Brochure pages: "Cut Drilling Costs 40 Percent or More with a Strata Bit PDC Bit Tailored to the Formation." Strata Bit. Admitted prior art.

Catalogue/Brochure page: "The Fast Track to the Bottom Line," p. 8. Strata Bit. Admitted prior art.

Catalogue/Brochure pages: "Standard PDC Bits; Standard Ringcutter PDC Bits; Gold Series Bits." Admitted prior art.

Catalogue/Brochure page: "Hycalog Introduces the Hybrid-Fishtail." Hycalog. Admitted prior art.

Catalogue/Brochure page: "Longer Bit Life and Superior Downhole Performance." Hycalog. Admitted Prior Art.

Catalogue/Brochure pages: 6 3/4 in. DS42H, et al. Hycalog. Admitted prior art.

Catalogue/Brochure pages: "Nortrak Navigation Drilling Systems," pp. 4-5. Nortrak. Admitted prior art.

Catalogue/Brochure pages: "VIII. Diamond Drilling & Coring Bits," pp. 47-48. Eastman Christensen. Admitted prior art.

Catalogue/Brochure pages: "Technical Data." Eastman Christensen. Admitted prior art.

Catalogue/Brochure pages: Rock Digger 15, et al. Admitted prior art.

Catalogue/Brochure pages: "Diamond Products." Smith International, pp. 12-13. Admitted prior art.

Catalogue/Brochure page: "PD-7 Rotary and Motor Bit; PD-11 Rotary Bit; PD-11X2 Rotary Bit." Admitted prior art.

(List continued on next page.)

Primary Examiner—Antoine Duval Davis
Attorney, Agent, or Firm—Browning Bushman

[57] **CLAIM**

The ornamental design for an eight blade drill bit, as shown and described.

DESCRIPTION

FIG. 1 is a top plan view of a eight blade drill bit showing our new design;

FIG. 2 is a front perspective view thereof;

FIG. 3 is a front elevational view thereof;

FIG. 4 is a left side elevational view thereof;

FIG. 5 is a rear elevational view thereof;

FIG. 6 is a right side elevational view thereof; and,

FIG. 7 is a bottom plan perspective view thereof.

1 Claim, 7 Drawing Sheets

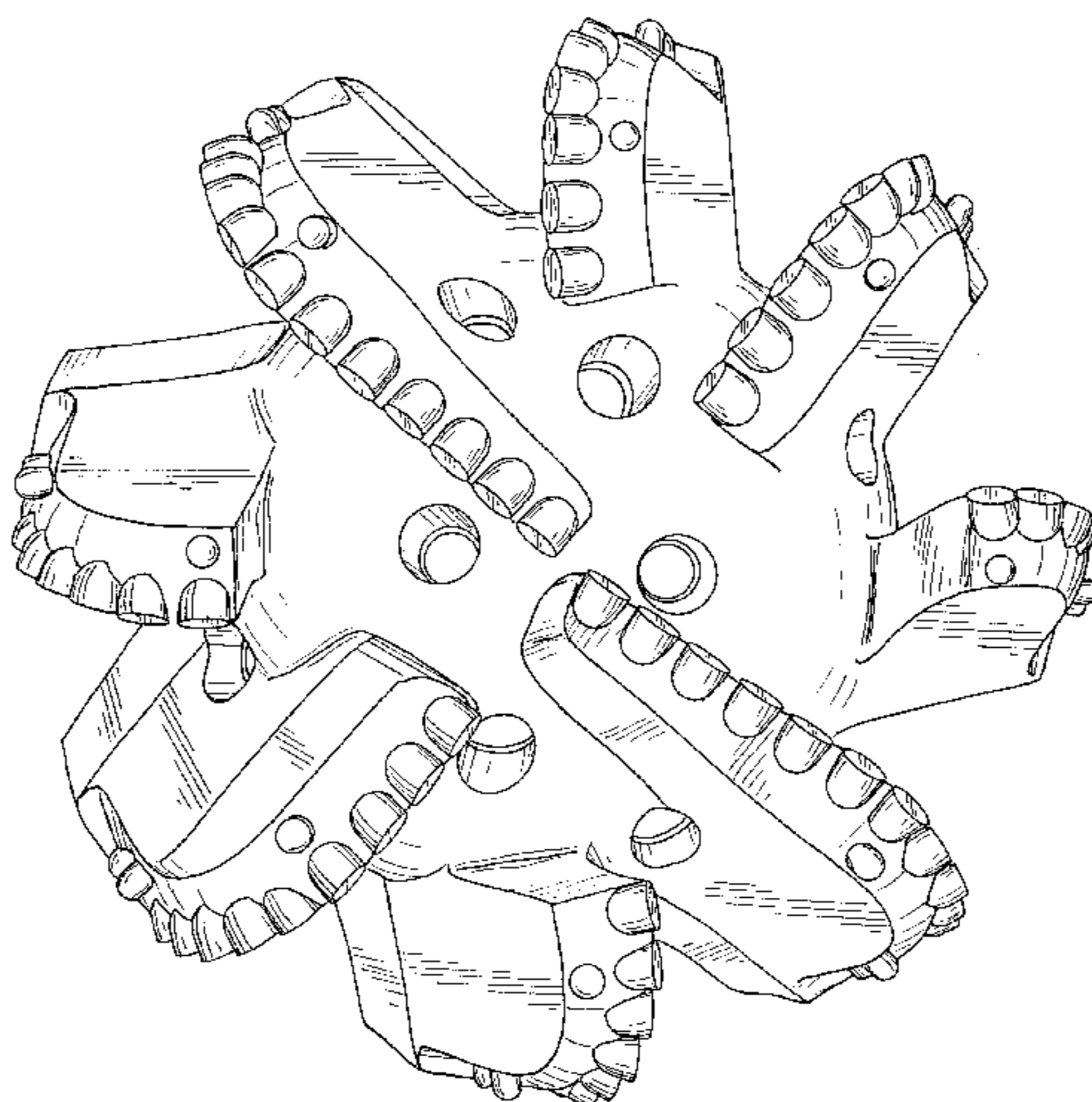

OTHER PUBLICATIONS

Catalogue/Brochure page: "Strata-Cut Drilling-Bits." Admitted prior art.

Catalogue/Brochure pages: "TD 2000 Series Drill Bits; TD Drill Bits; PD Steel Body Drill Bits." Diamont Boart Strat-bit. Admitted prior art.

Catalogue/Brochure pages: "Diamond Compact Bits (R-Series)." Norton Christensen Drilling Products. Admitted prior art.

Catalogue/Brochure pages: "Bit Description" Admitted prior art.

Catalogue/Brochure page: "Put the Best on the Bottom." BiTech. Admitted prior art.

Catalogue/Brochure pages: 8½ in Hornet 4, et al. Reed Tool Company. Admitted prior art.

Catalogue/Brochure pages: "Diamond Compact Bits (R-Series)," pp. 11-12. Eastman Christensen. Admitted prior art.

Catalogue/Brochure page: "Smith Diamond's New S-95: The Right Direction in Soft Formations." Smith International. Admitted prior art.

Catalogue/Brochure pages: "Drilling Bits." Petroleum Diamond Products. Admitted prior art.

Catalogue/Brochure page: "Diataq DS." Admitted prior art.

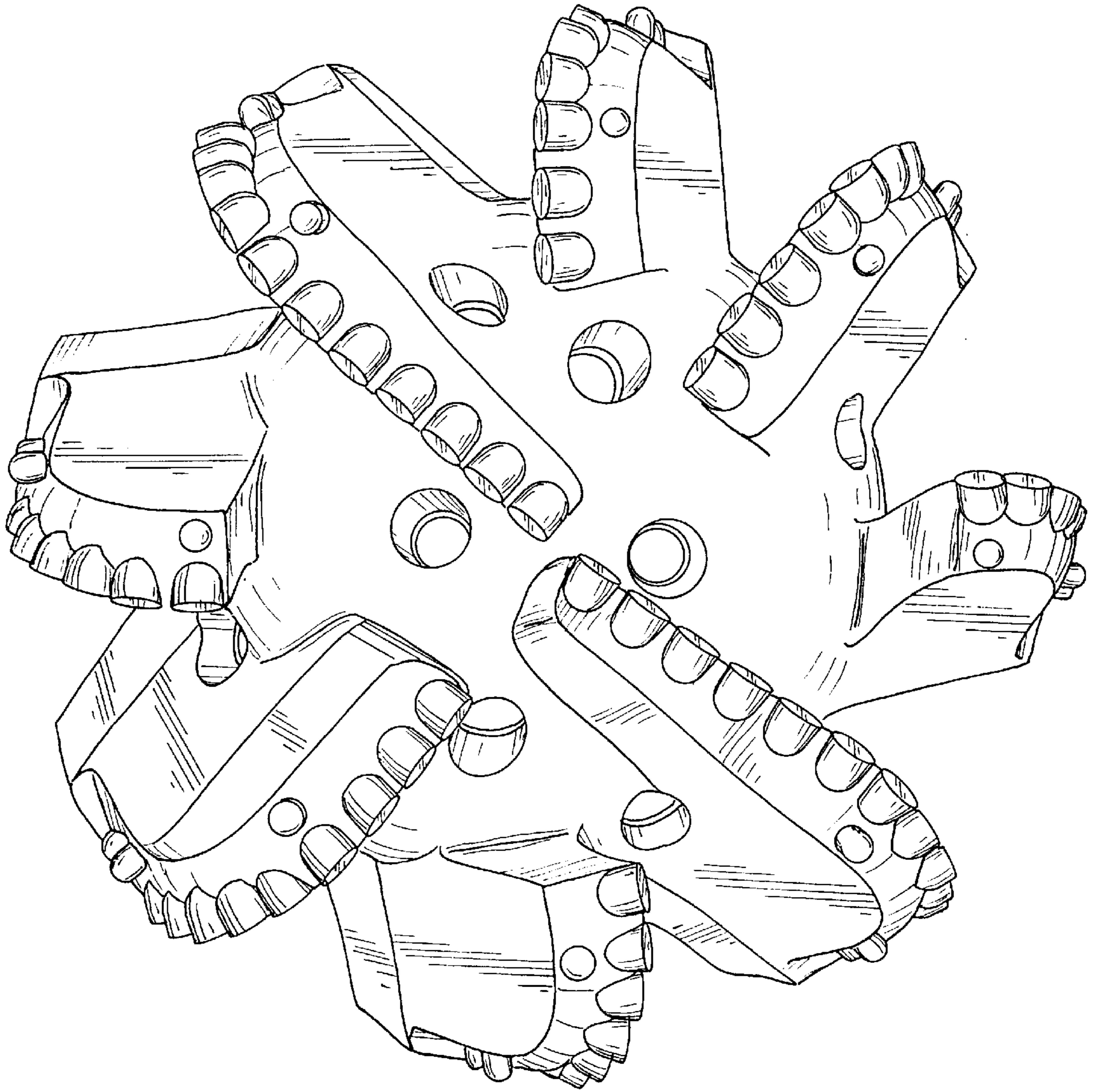

FIG. 1

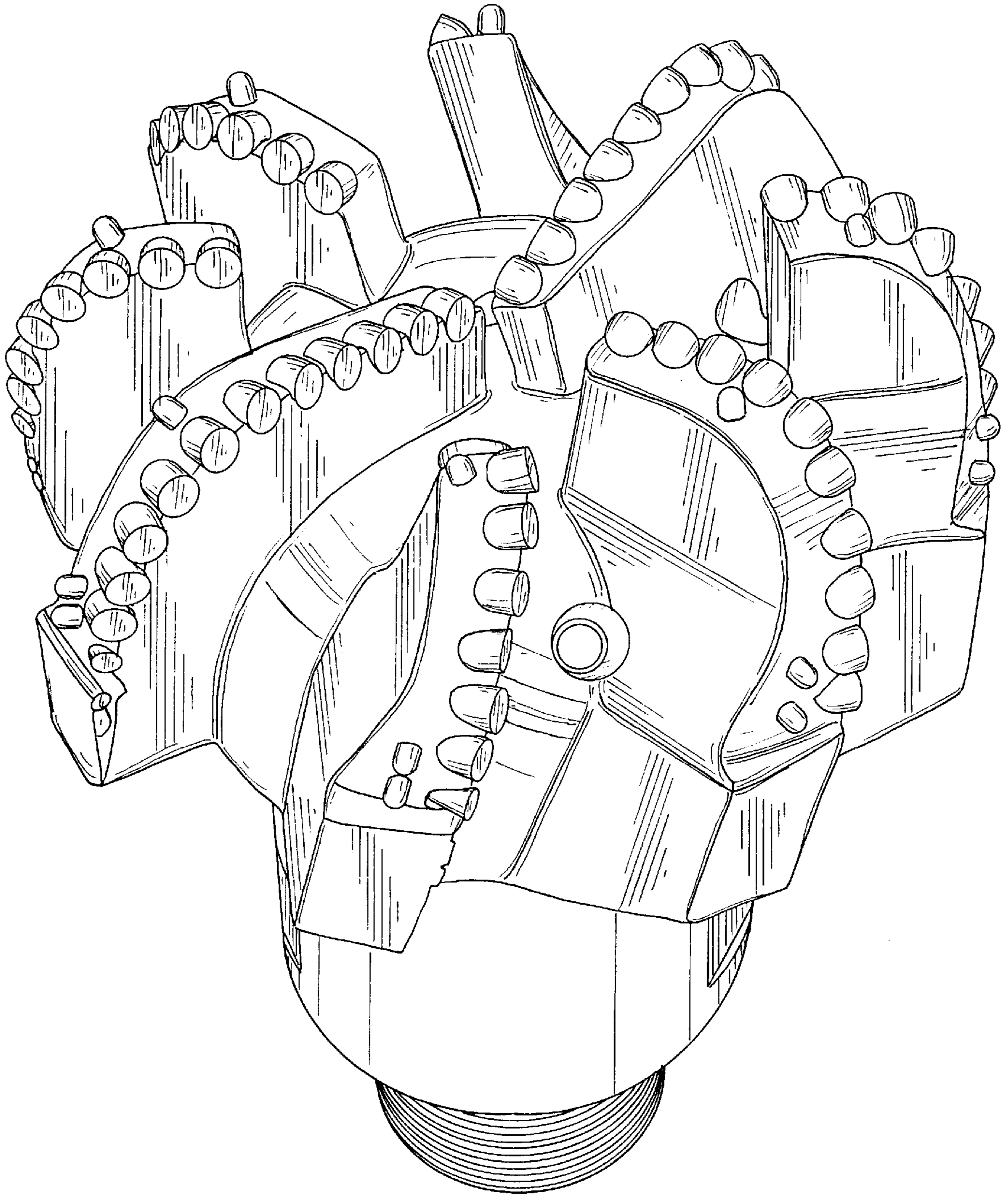

FIG. 2

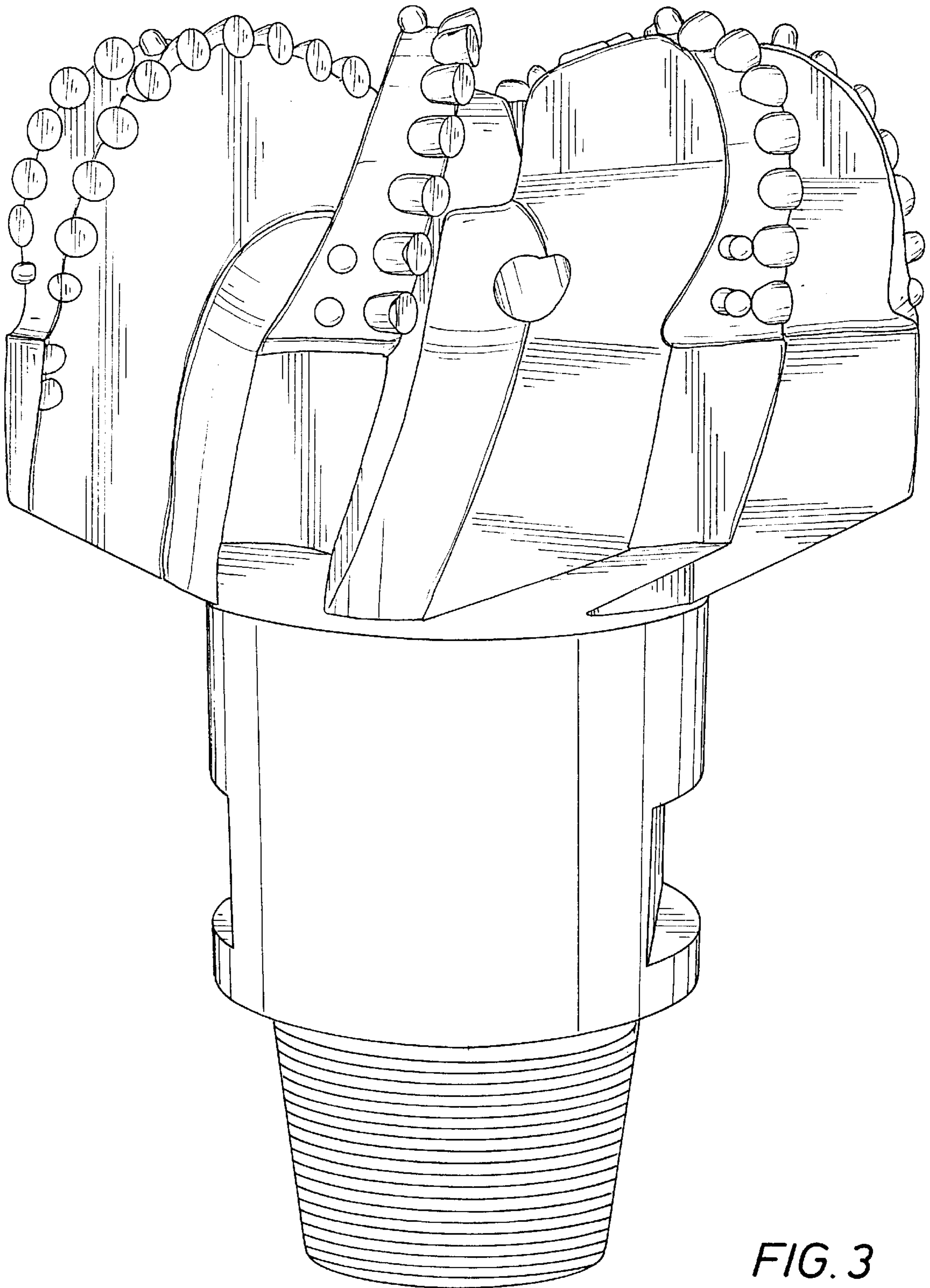

FIG. 3

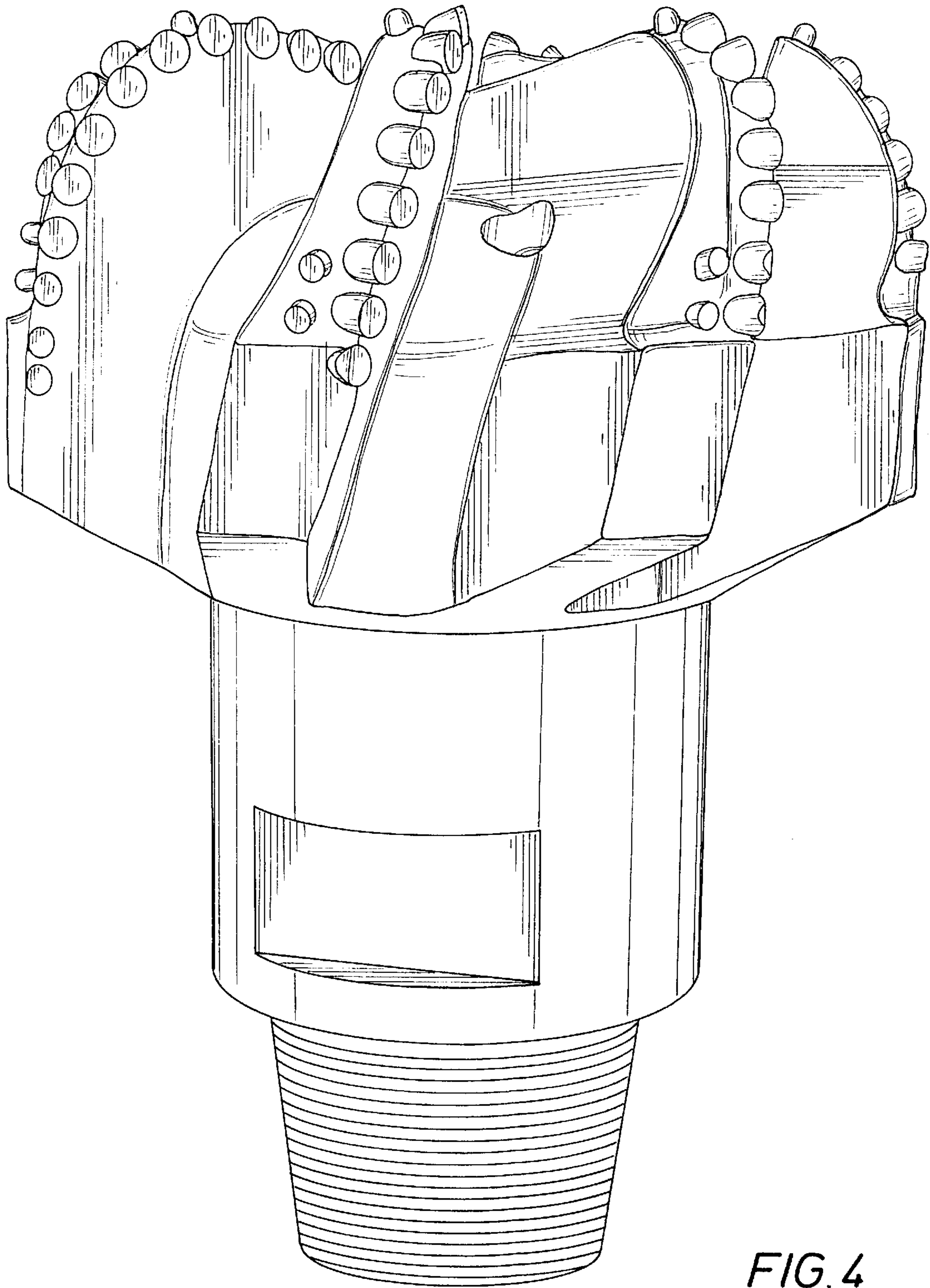

FIG. 4

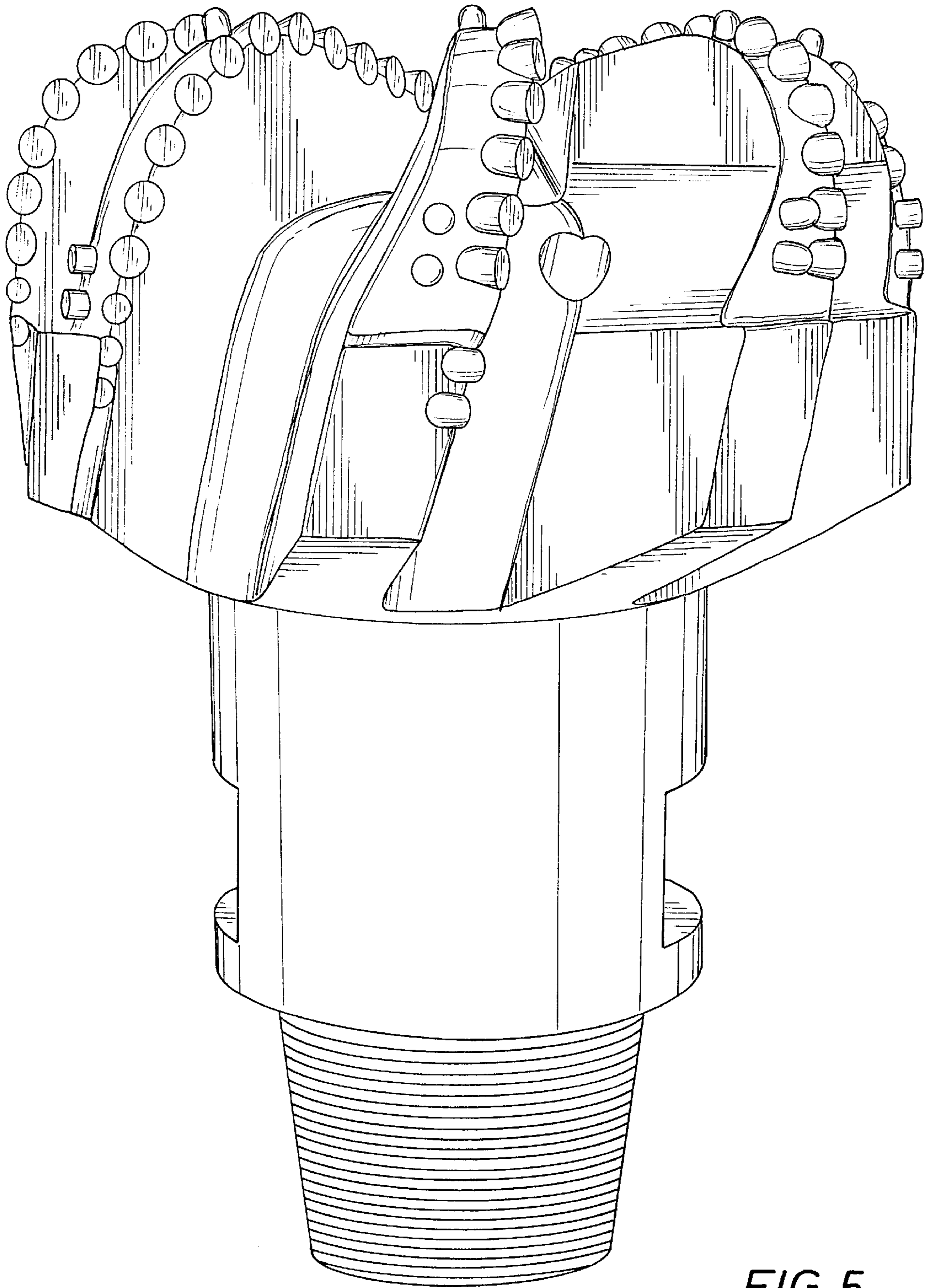

FIG. 5

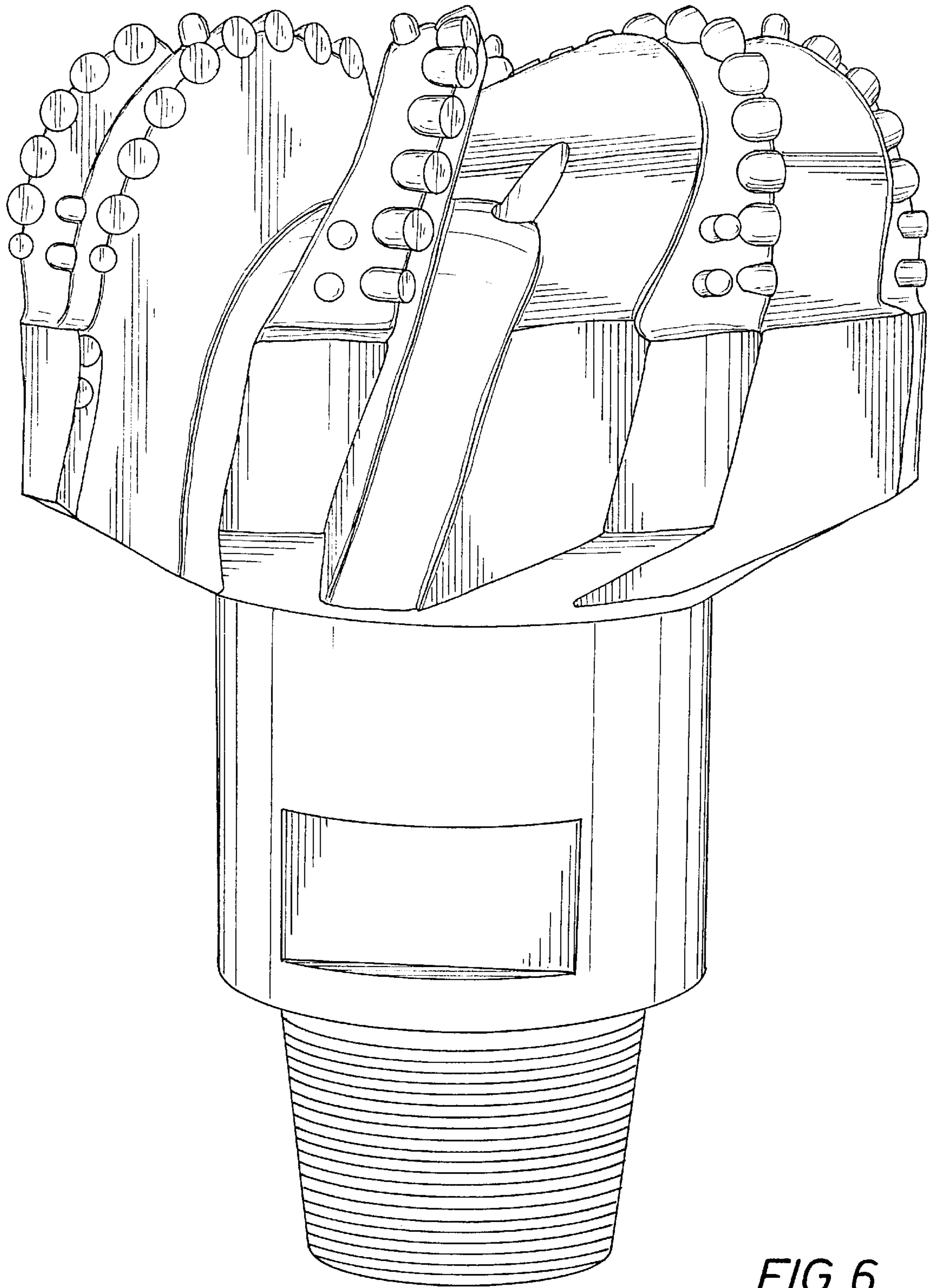

FIG. 6

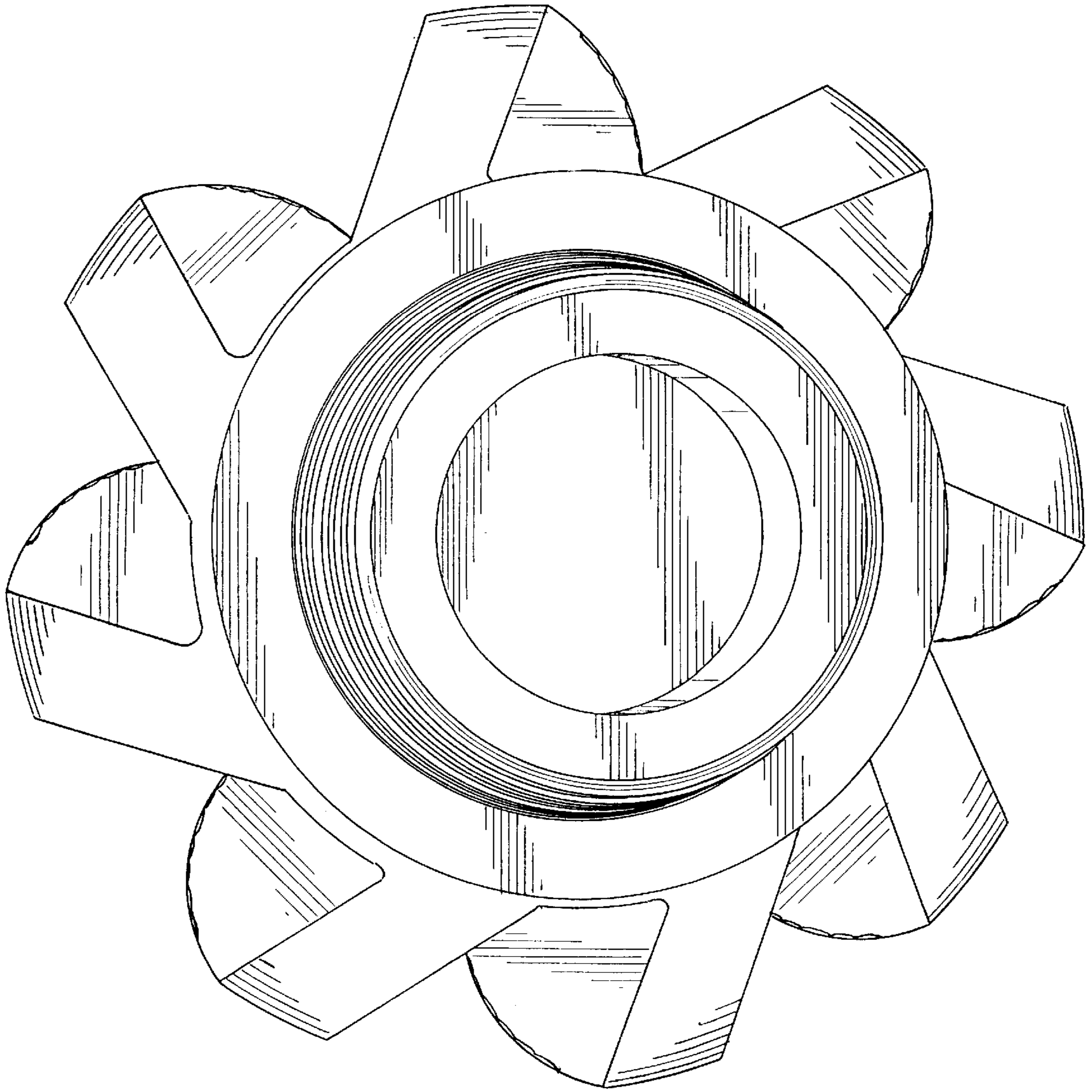

FIG. 7