



US00D404383S

United States Patent [19] Chang

[11] Patent Number: **Des. 404,383**

[45] Date of Patent: ****Jan. 19, 1999**

[54] **COMBINED REMOVABLE HARD DISK DRIVE HOLDER AND CASSETTE**

[75] Inventor: **Dean Chang**, Taipei, Taiwan

[73] Assignee: **Sailing Strong International Co., Ltd.**, Taiwan

[**] Term: **14 Years**

[21] Appl. No.: **74,932**

[22] Filed: **Aug. 13, 1997**

[51] **LOC (6) Cl.** **14-02**

[52] **U.S. Cl.** **D14/114**

[58] **Field of Search** D14/100, 107, D14/109, 114; D13/162, 184, 199; 312/292; 360/99.01-99.12; 369/36; 361/679-87, 729-34; 379/93.01

[56] **References Cited**

U.S. PATENT DOCUMENTS

D. 287,726	1/1987	Itoh et al.	D14/109
D. 308,052	5/1990	Darden et al.	D14/109
D. 358,141	5/1995	Pecone et al.	D14/109
D. 374,216	10/1996	Paul	D14/107
D. 383,736	9/1997	Corrington et al.	D14/109
D. 387,742	12/1997	Lain	D14/109
D. 389,470	1/1998	Schick et al.	D14/114
D. 391,938	3/1998	D'Agaro et al.	D14/114

OTHER PUBLICATIONS

P.C. Week—Buyers Guide—Jan. 15, 1985, Hard Disk Storage Kamerman Labs.

Primary Examiner—M. H. Tung

Attorney, Agent, or Firm—Claude A. S. Hamrick; Chien-Wei Chris Chou; Oppenheimer W. Donnelly

[57] **CLAIM**

The ornamental design for a removable combined hard disk drive holder and cassette, as shown and described.

DESCRIPTION

FIG. 1 is a front, right, top perspective view of a combined removable hard disk drive holder and cassette showing my new design;

FIG. 2 is a front, right, top perspective view thereof, the removable hard disk drive holder is shown separately for clarity of illustration;

FIG. 3 is a right side elevation view thereof;

FIG. 4 is a left side elevation view thereof;

FIG. 5 is a front elevation view thereof;

FIG. 6 is a rear elevation view thereof;

FIG. 7 is a top view thereof;

FIG. 8 is a bottom view thereof;

FIG. 9 is a front, right, top perspective view thereof, the cassette is shown separately for clarity of illustration;

FIG. 10 is a right side elevation view thereof;

FIG. 11 is a left side elevation view thereof;

FIG. 12 is a front elevation view thereof;

FIG. 13 is a rear elevation view thereof;

FIG. 14 is a top view thereof; and,

FIG. 15 is a bottom view thereof.

1 Claim, 4 Drawing Sheets

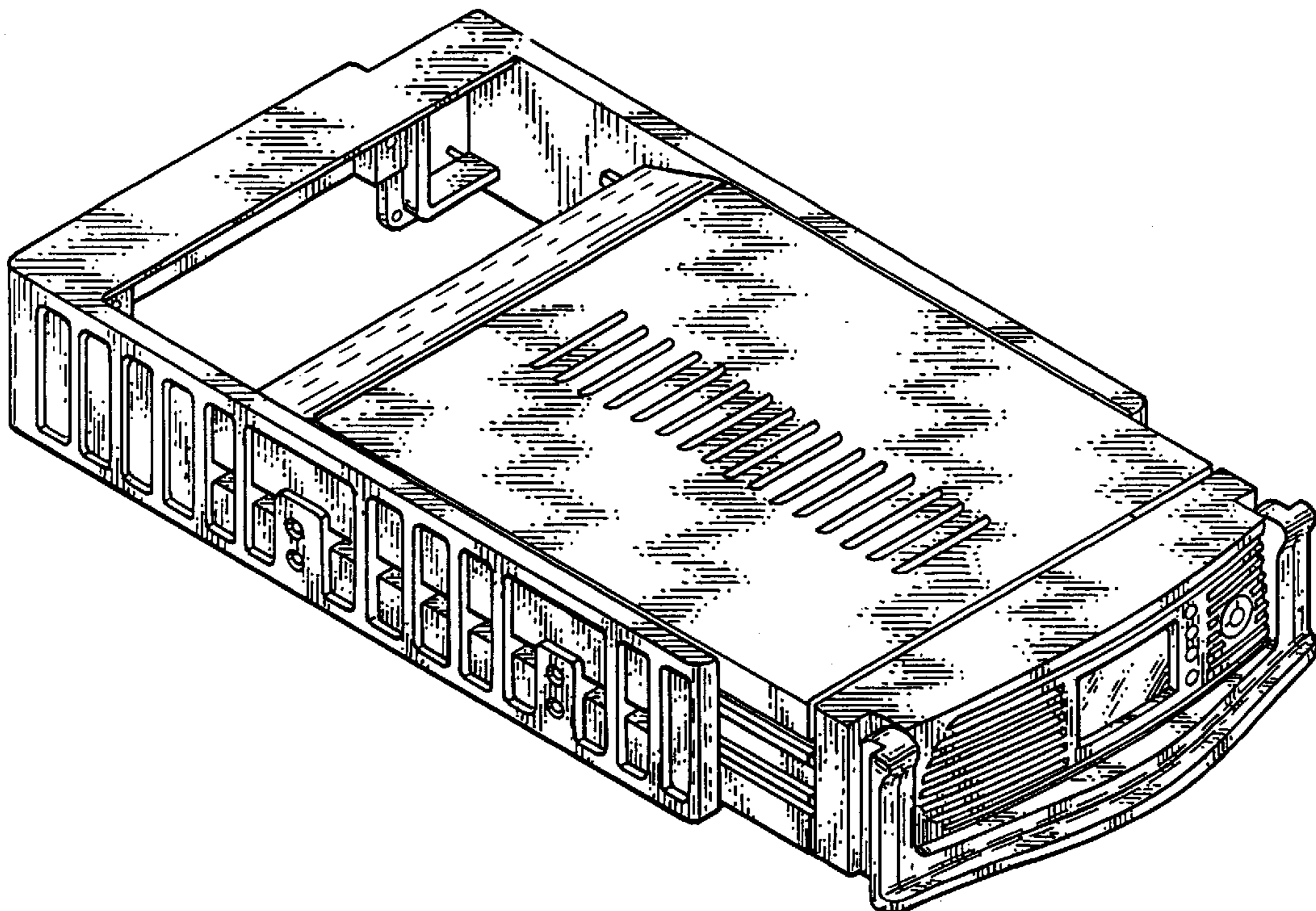

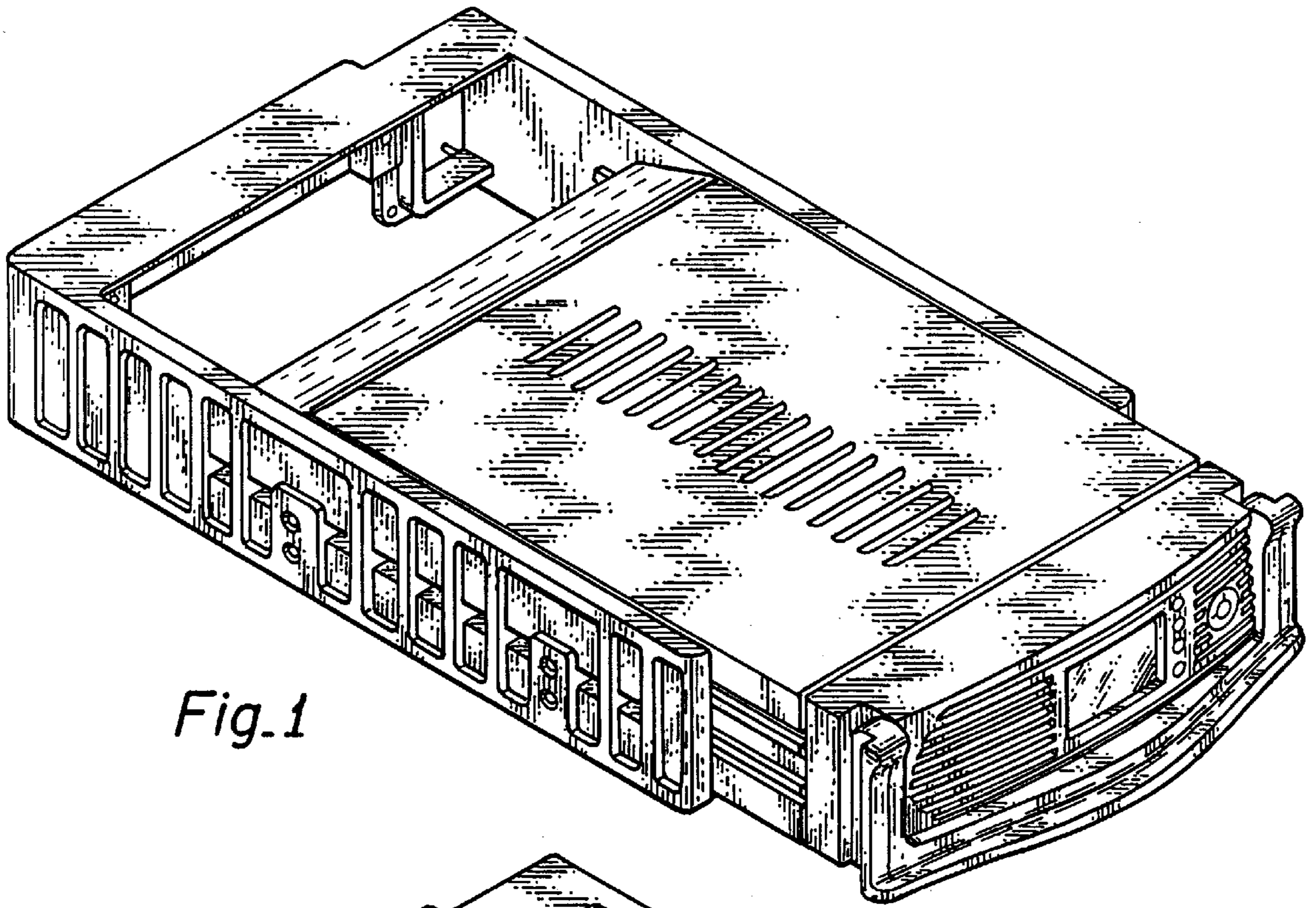

Fig. 1

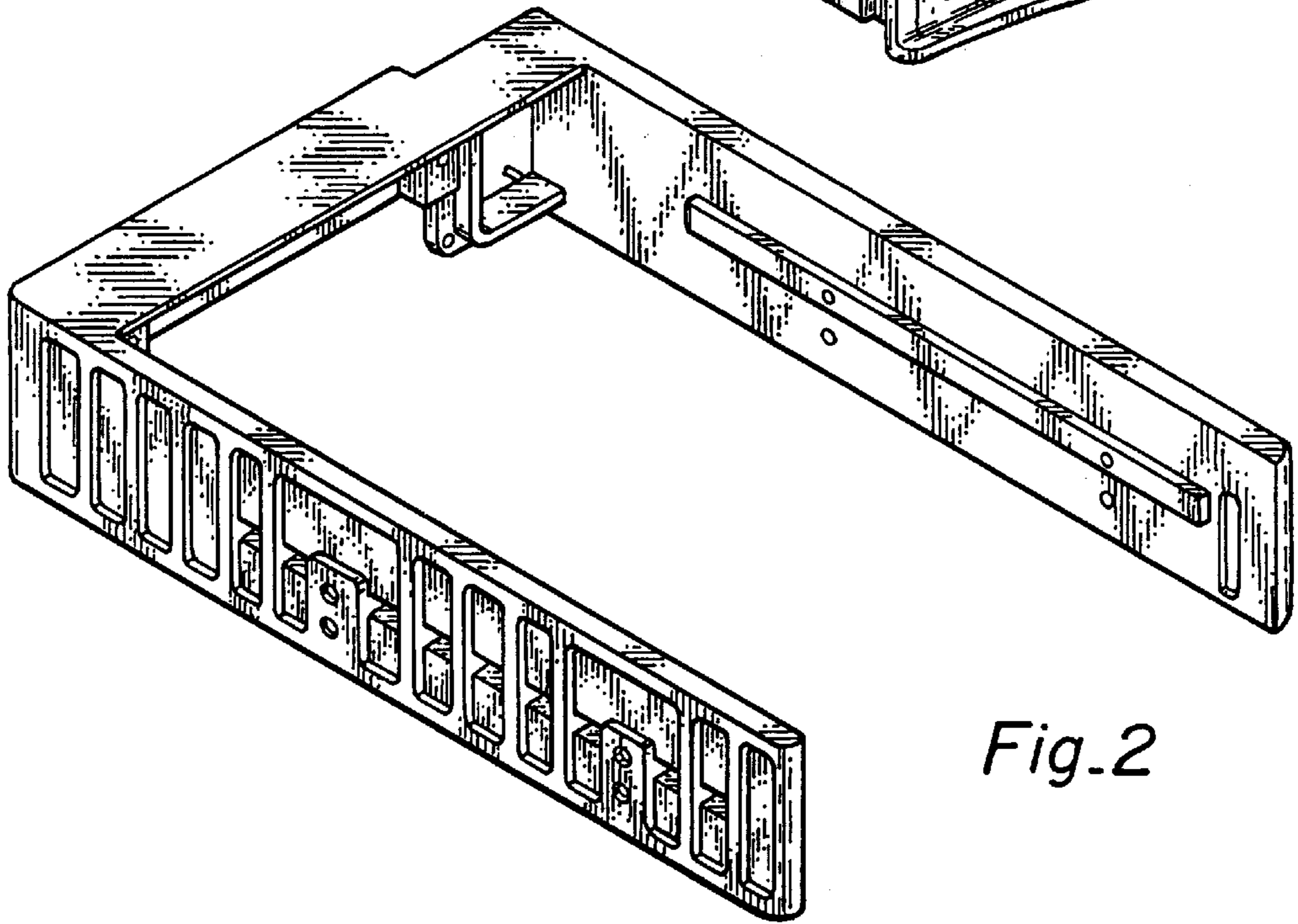

Fig. 2

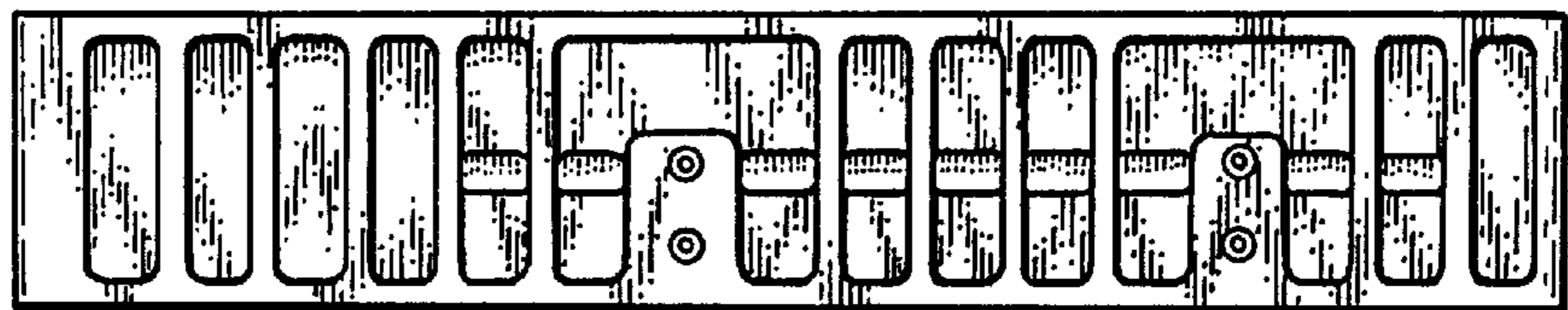

Fig. 3

Fig.4

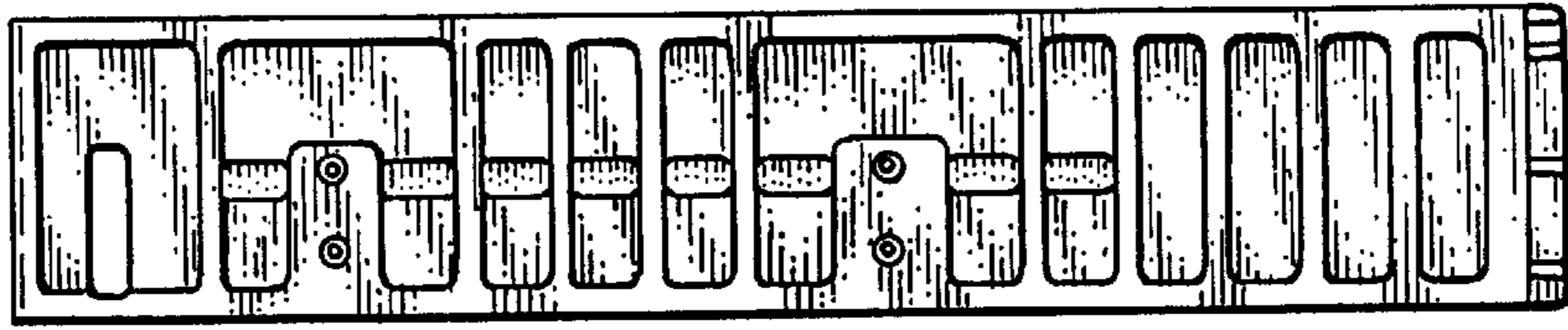

Fig.5

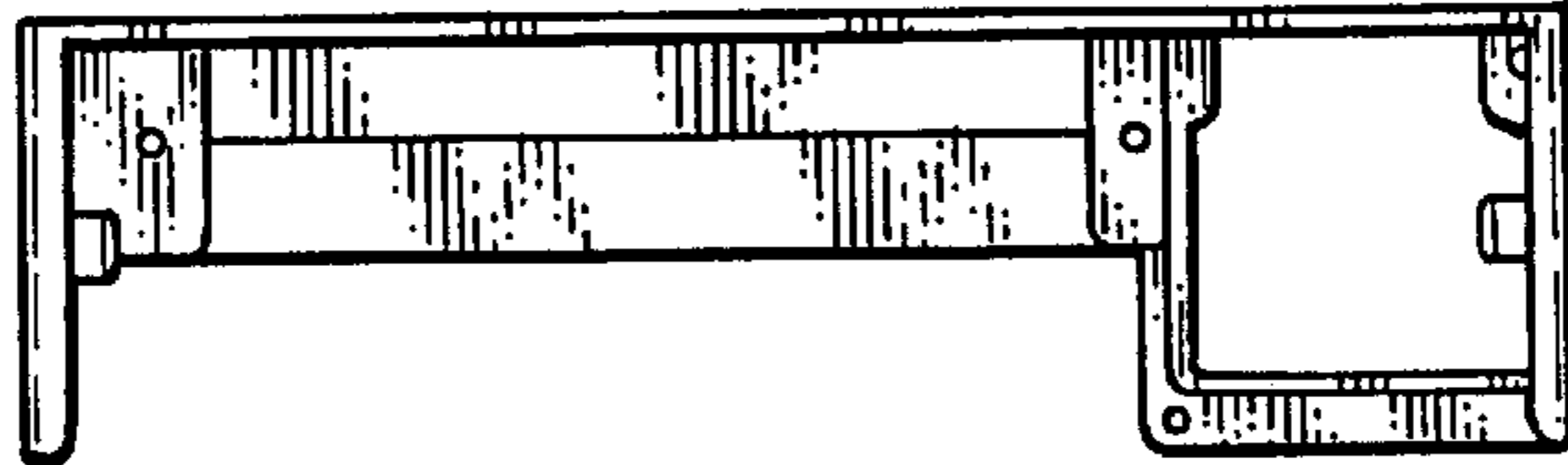

Fig.6

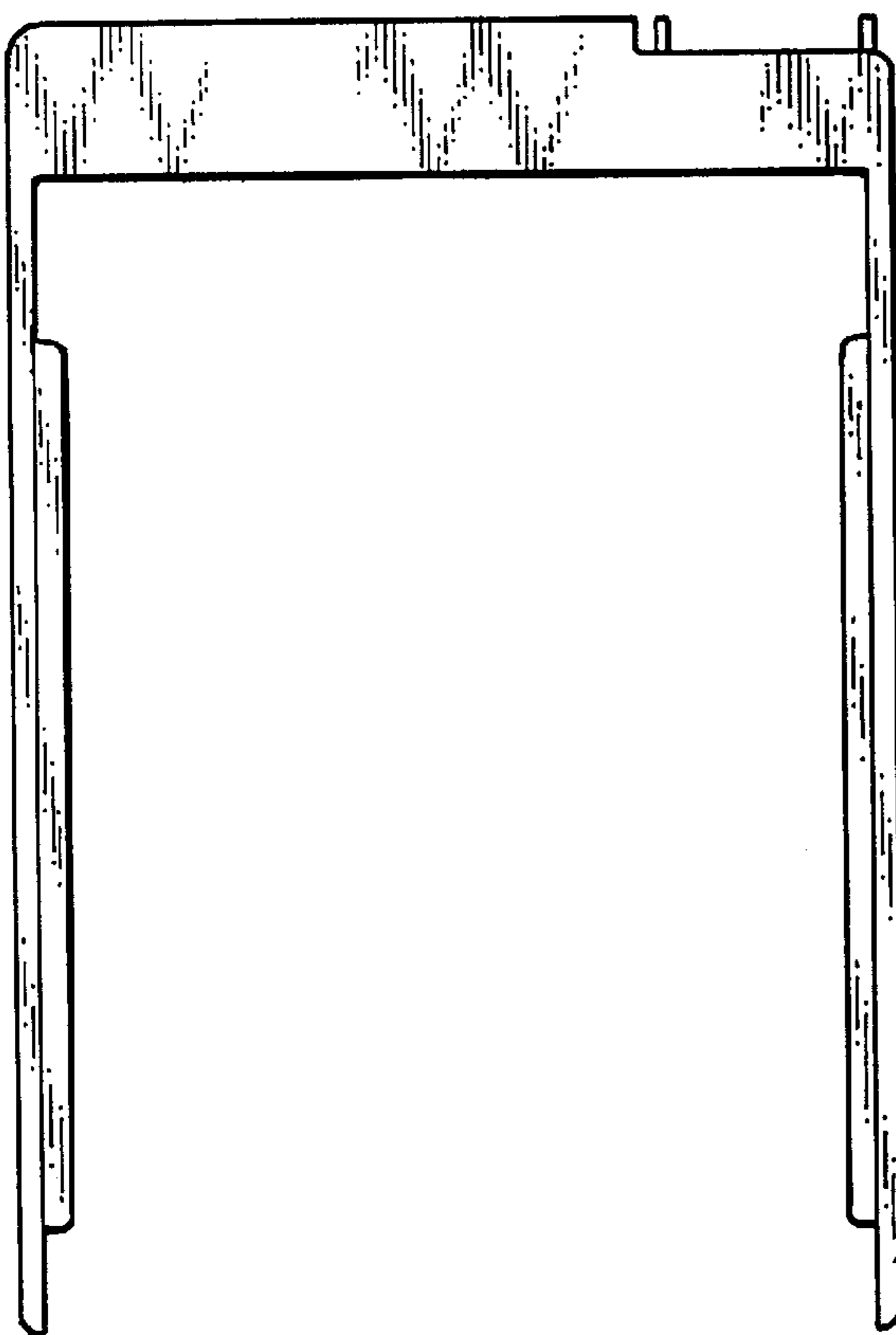

Fig.7

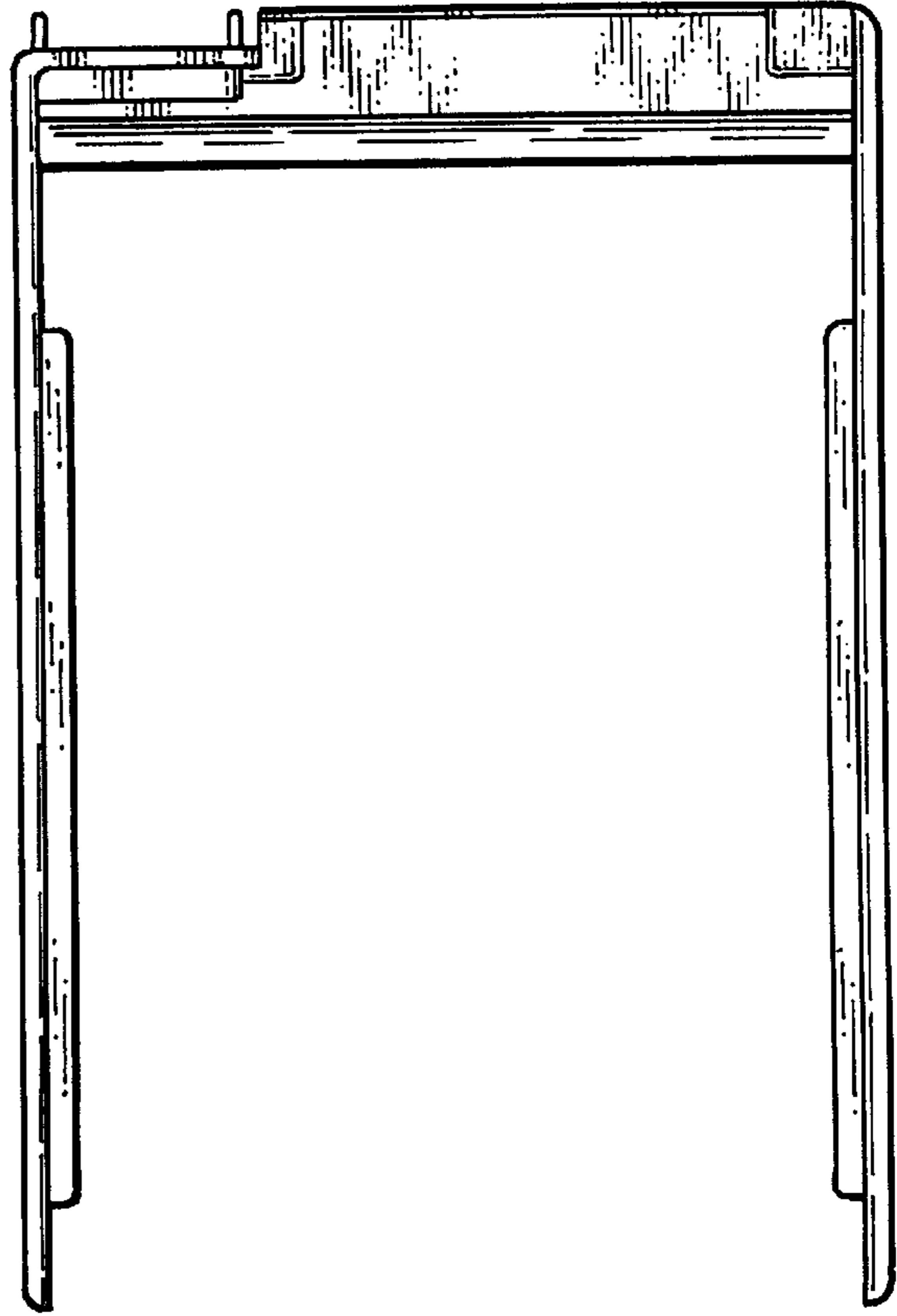

Fig.8

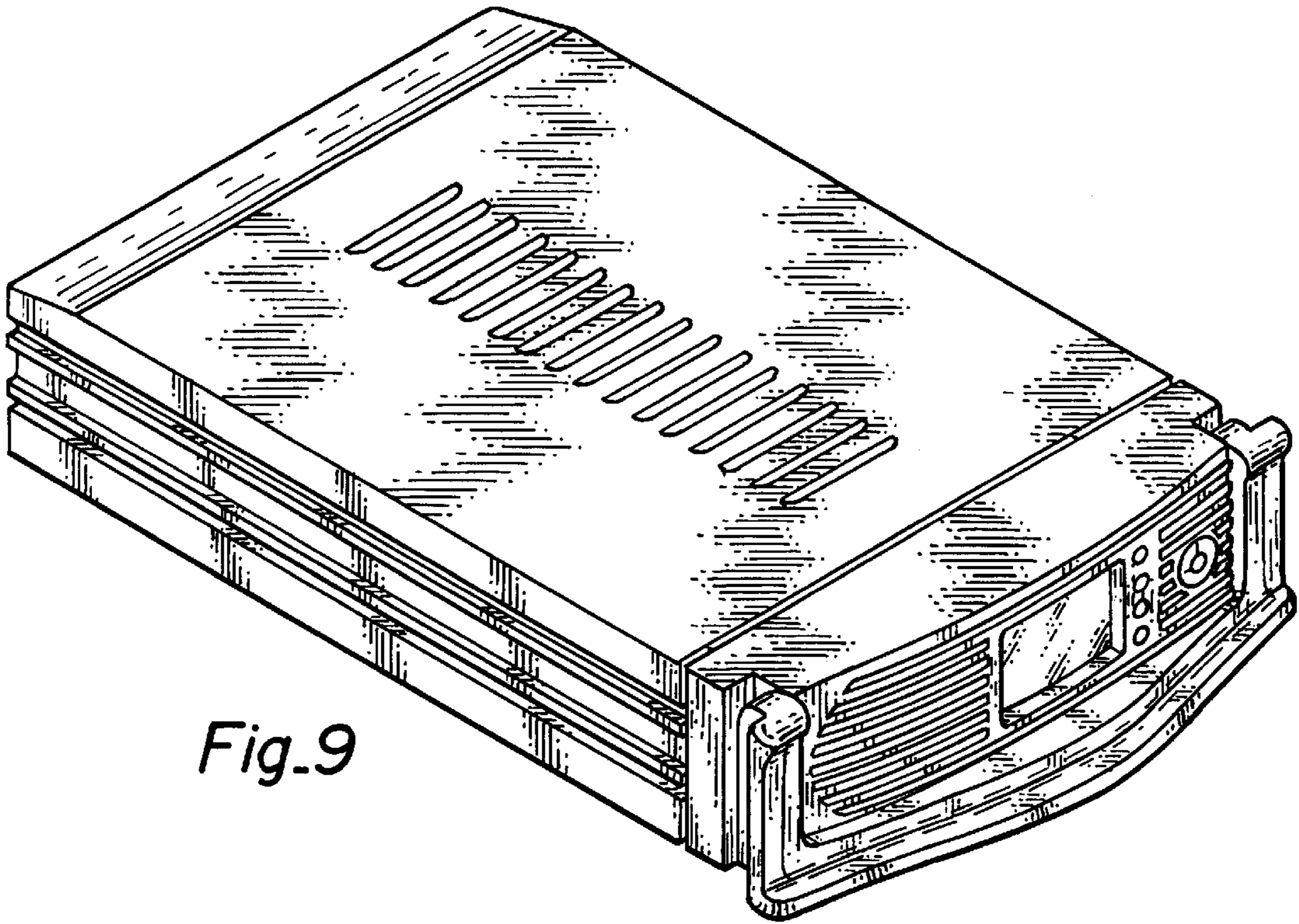

Fig.9

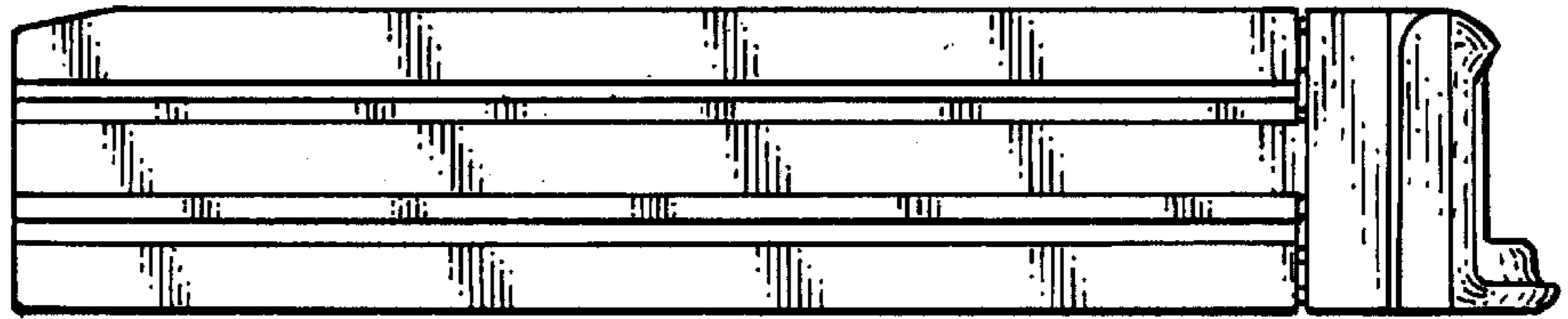

Fig.10

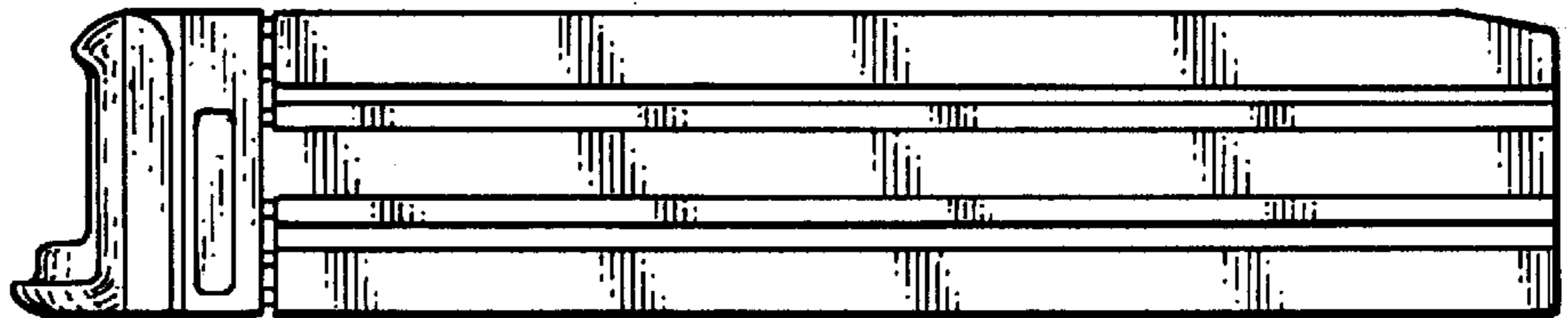

Fig.11

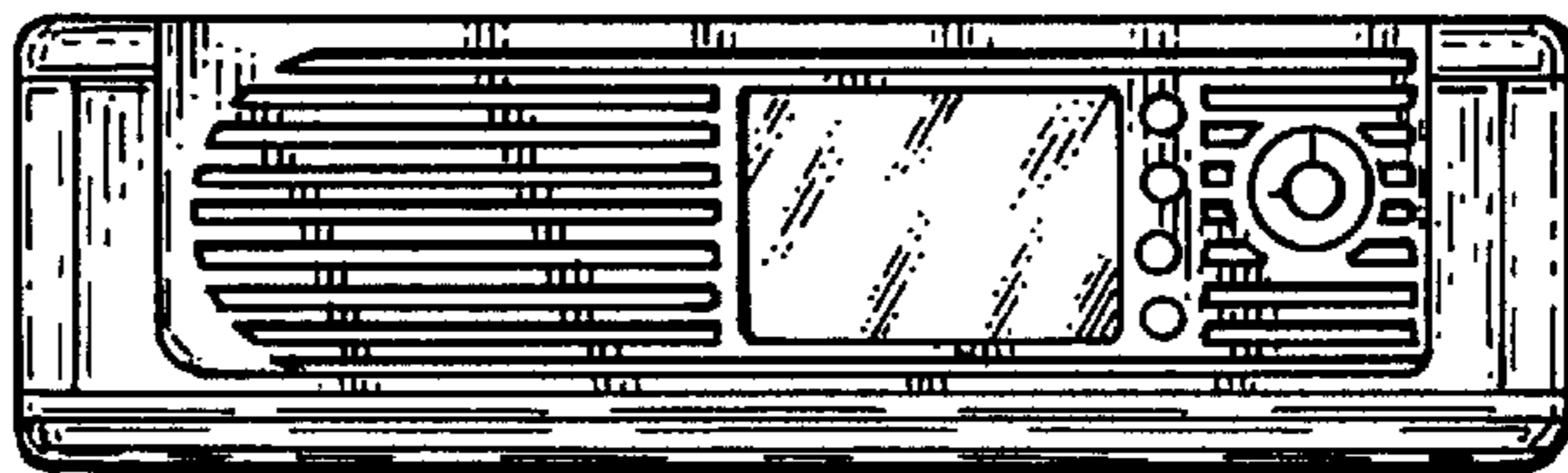

Fig.12

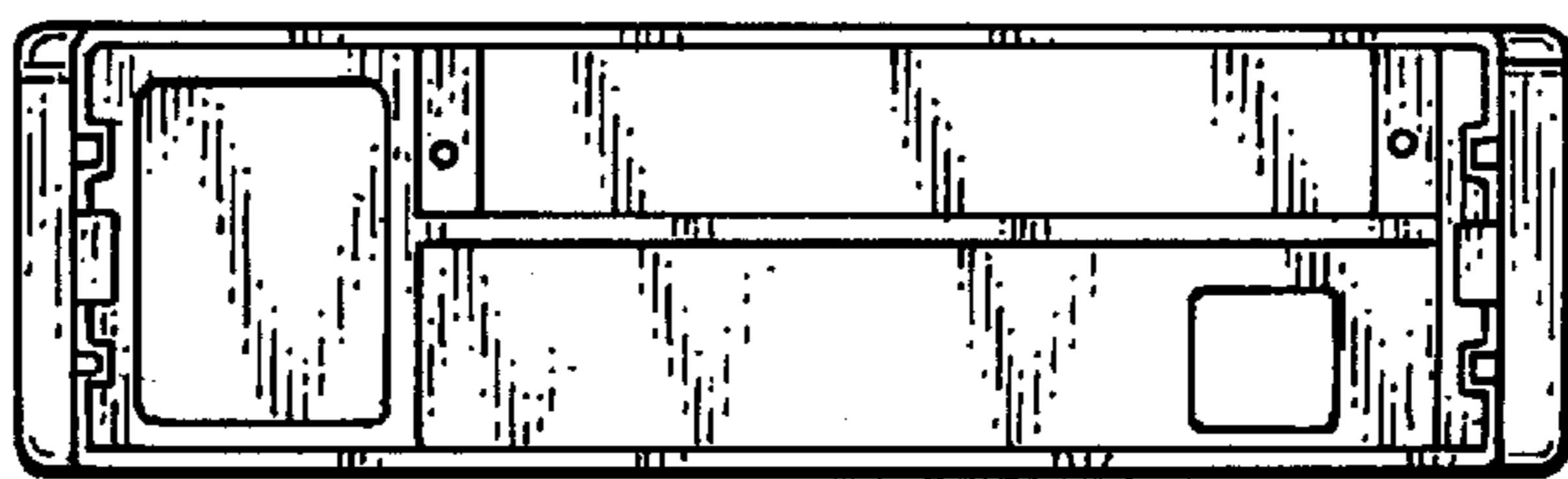

Fig.13

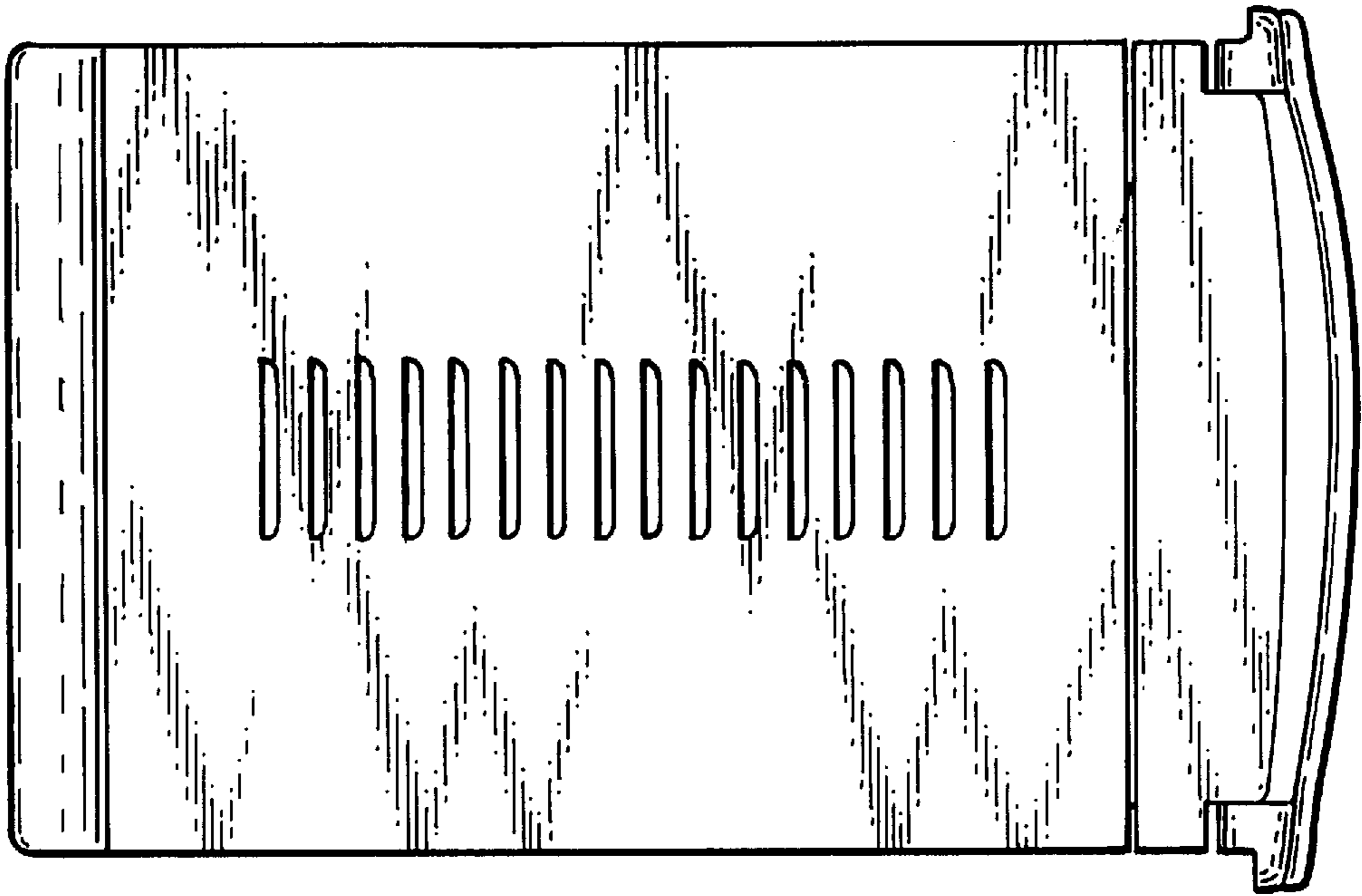

Fig. 14

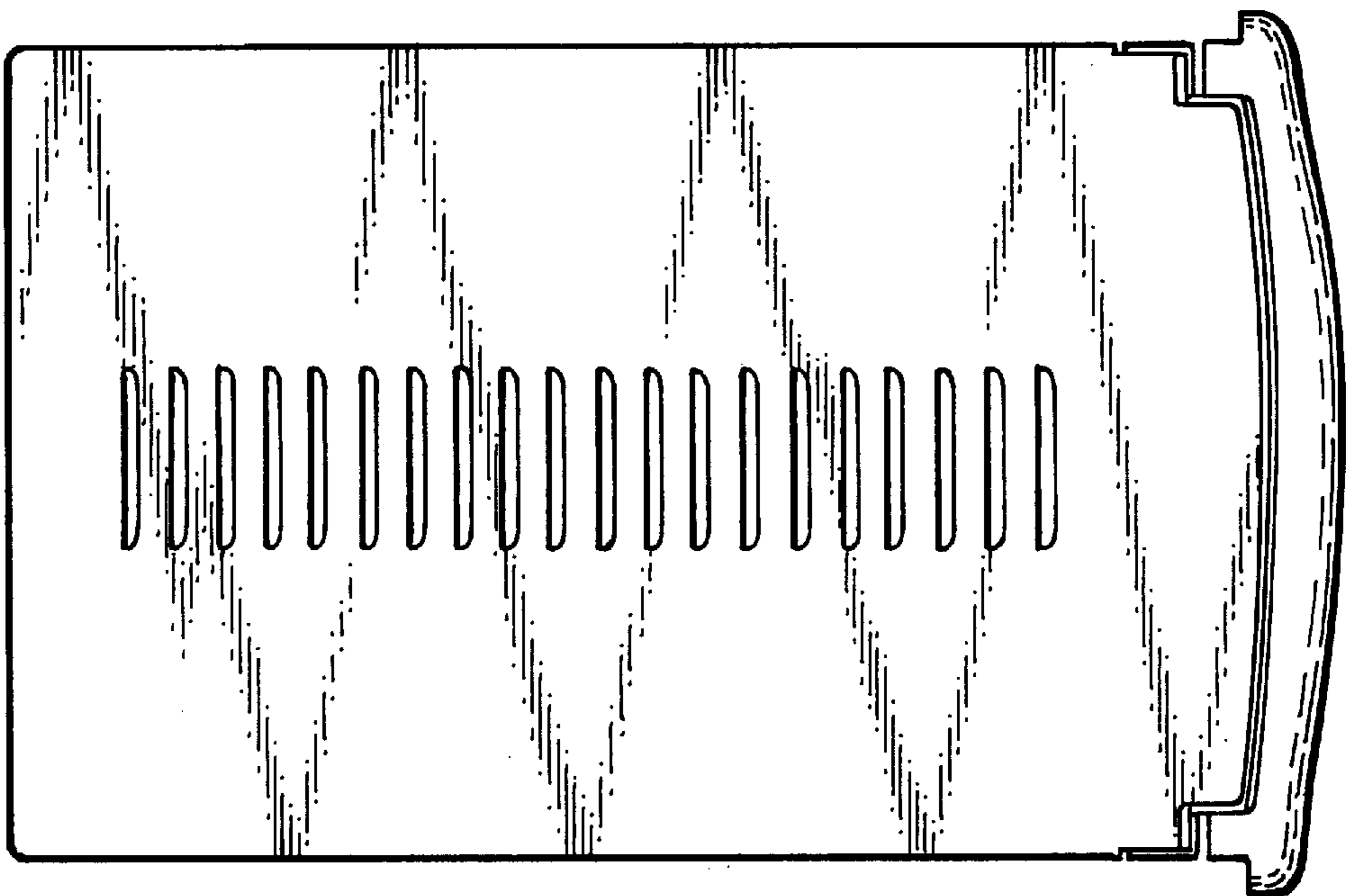

Fig. 15