



US00D404345S

United States Patent [19]

[11] **Patent Number: Des. 404,345**

Donets

[45] **Date of Patent: **Jan. 19, 1999**

[54] **WALKER FRAME WITH BOTTOM SLIDE MEMBERS**

[76] Inventor: **Vladimir L. Donets**, 2905 Covert Rd., Glenview, Ill. 60025

[**] Term: **14 Years**

[21] Appl. No.: **67,862**

[22] Filed: **Apr. 7, 1997**

[51] **LOC (6) Cl.** **12-12**

[52] **U.S. Cl.** **D12/130**

[58] **Field of Search** D12/128-133;
135/67, 68, 69, 72, 73, 84; 297/6

[56] **References Cited**

U.S. PATENT DOCUMENTS

D. 246,036	10/1977	Thomas	D12/130
D. 246,302	11/1977	Thomas	D12/130
4,800,910	1/1989	Gamm	135/67
5,649,558	7/1997	Richard	135/67

Primary Examiner—Kay H. Chin

Attorney, Agent, or Firm—Robert A. Brown

[57] **CLAIM**

The ornamental design for a walker frame with bottom slide members, as shown and described.

DESCRIPTION

FIG. 1 is a perspective view of a walker frame with bottom slide members showing my new design;

FIG. 2 is a top plan view of a second embodiment of the walker frame with bottom slide members;

FIG. 3 is a left side elevational view of FIG. 2;

FIG. 4 is a front elevational view of FIG. 2;

FIG. 5 is a right side elevational view of FIG. 2;

FIG. 6 is an enlarged view of a bottom slide member of the walker frame;

FIG. 7 is a bottom plan view of FIG. 2;

FIG. 8 is a rear elevational view of FIG. 2;

FIG. 9 is a top plan view of FIG. 1;

FIG. 10 is a left side elevational view of FIG. 1;

FIG. 11 is a front elevational view of FIG. 1;

FIG. 12 is a right side elevational view of FIG. 1;

FIG. 13 is a bottom plan view of FIG. 1;

FIG. 14 is a rear elevational view of FIG. 1;

FIG. 15 is a top plan view of a third embodiment of the walker frame with bottom slide members;

FIG. 16 is a left side elevational view of FIG. 15;

FIG. 17 is a front elevational view of FIG. 15;

FIG. 18 is a right elevational view of FIG. 15;

FIG. 19 is a bottom plan view of FIG. 15; and,

FIG. 20 is a rear elevational view of FIG. 15.

1 Claim, 4 Drawing Sheets

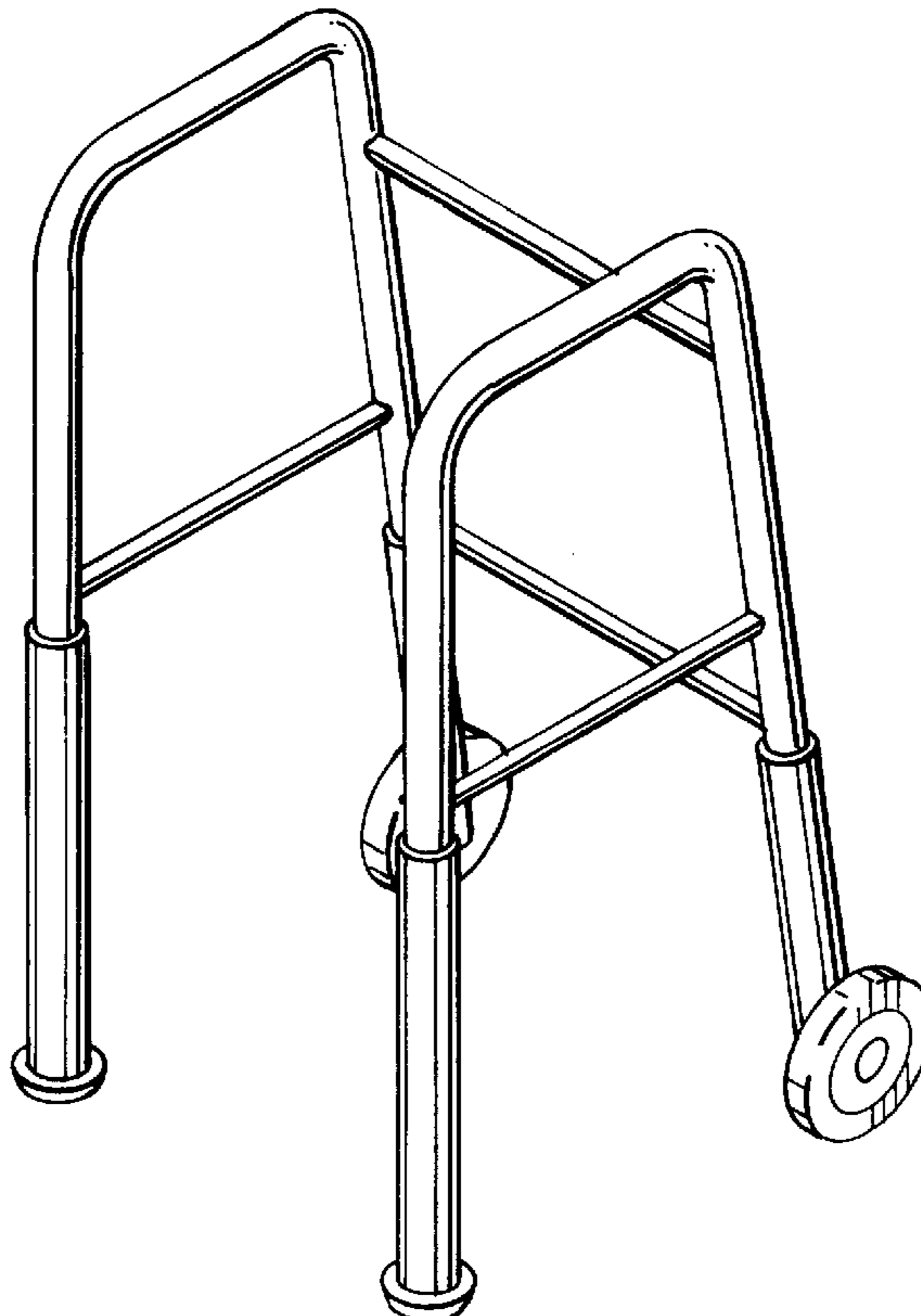

FIG. 1

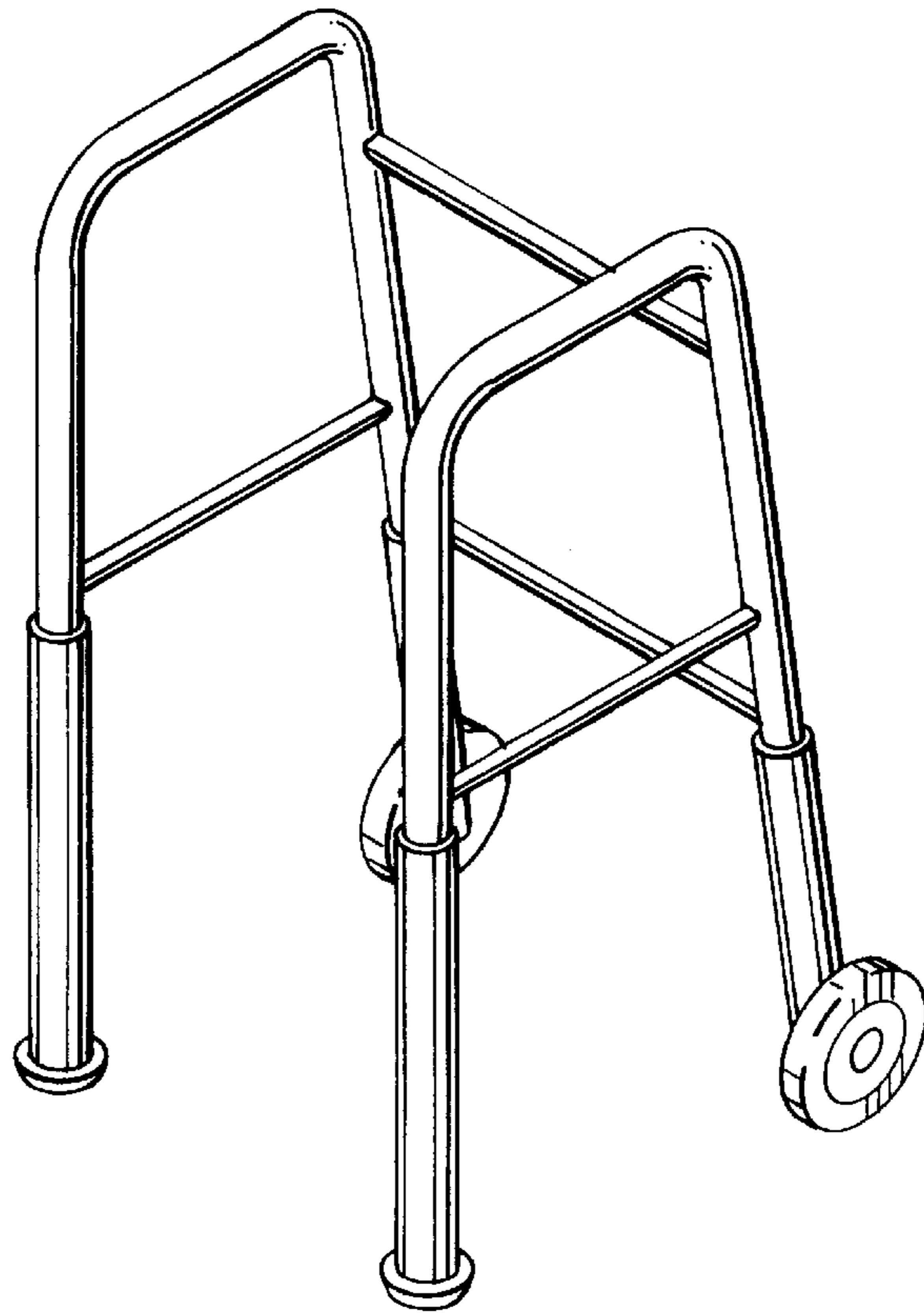

FIG. 2

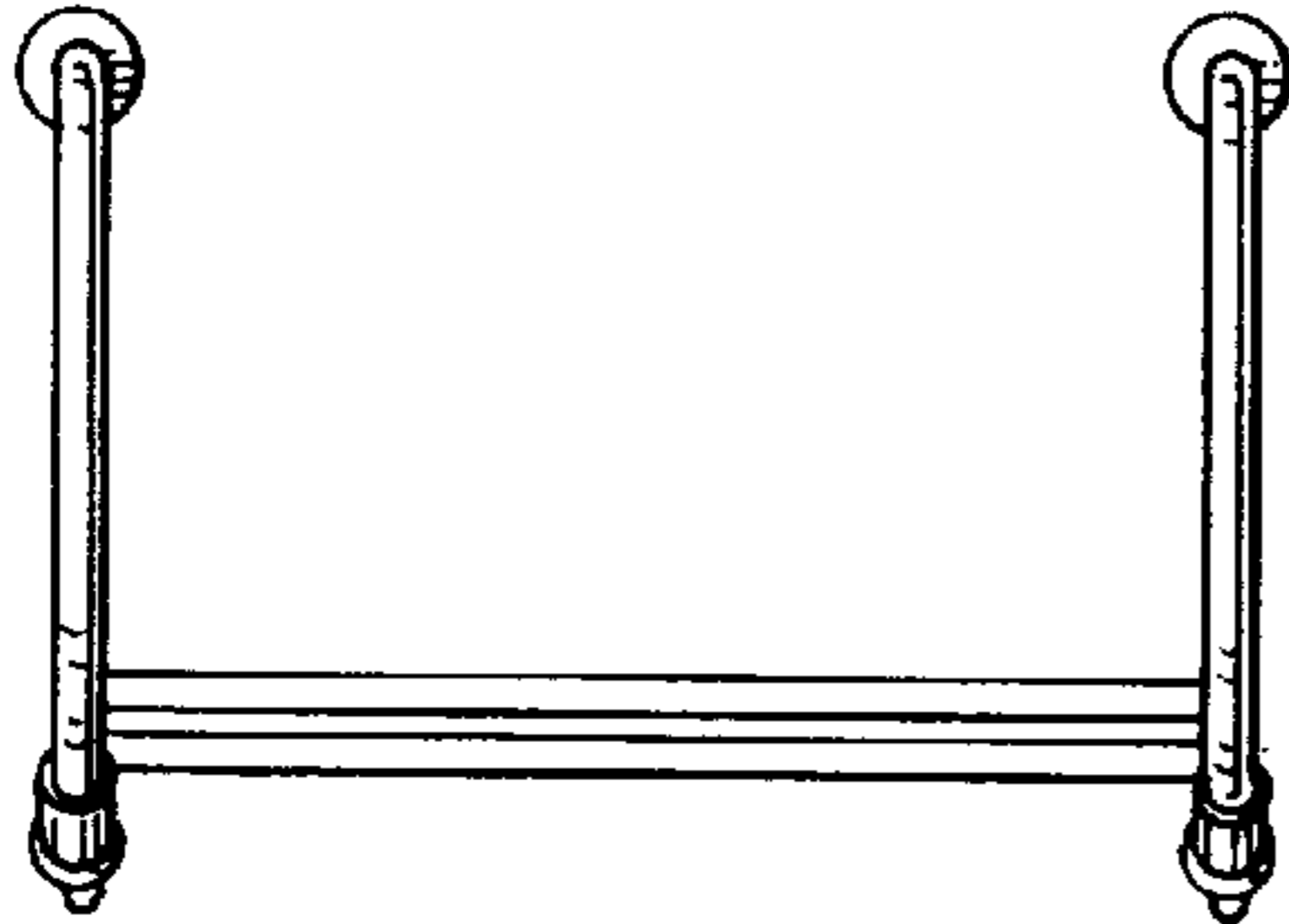

FIG. 3

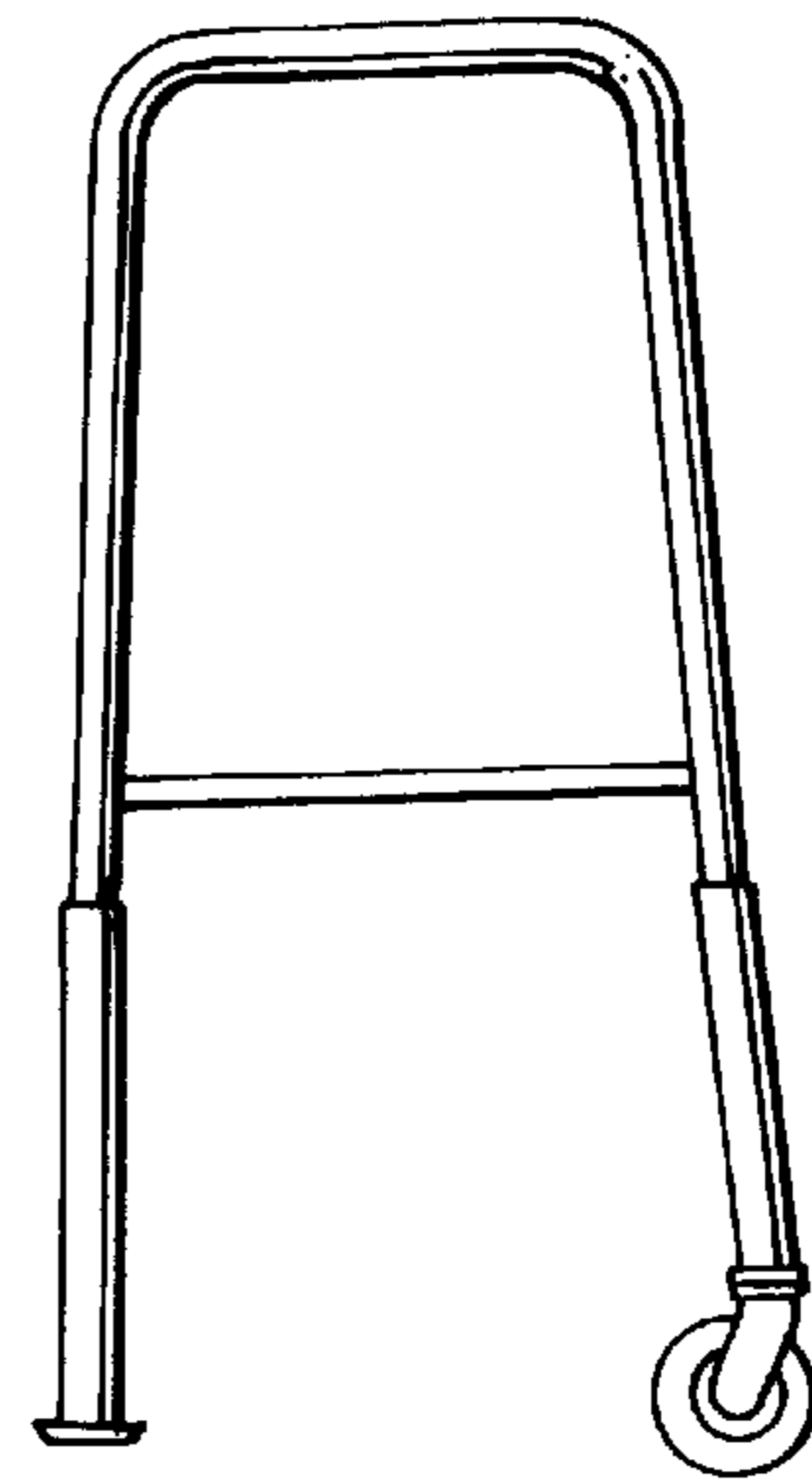

FIG. 4

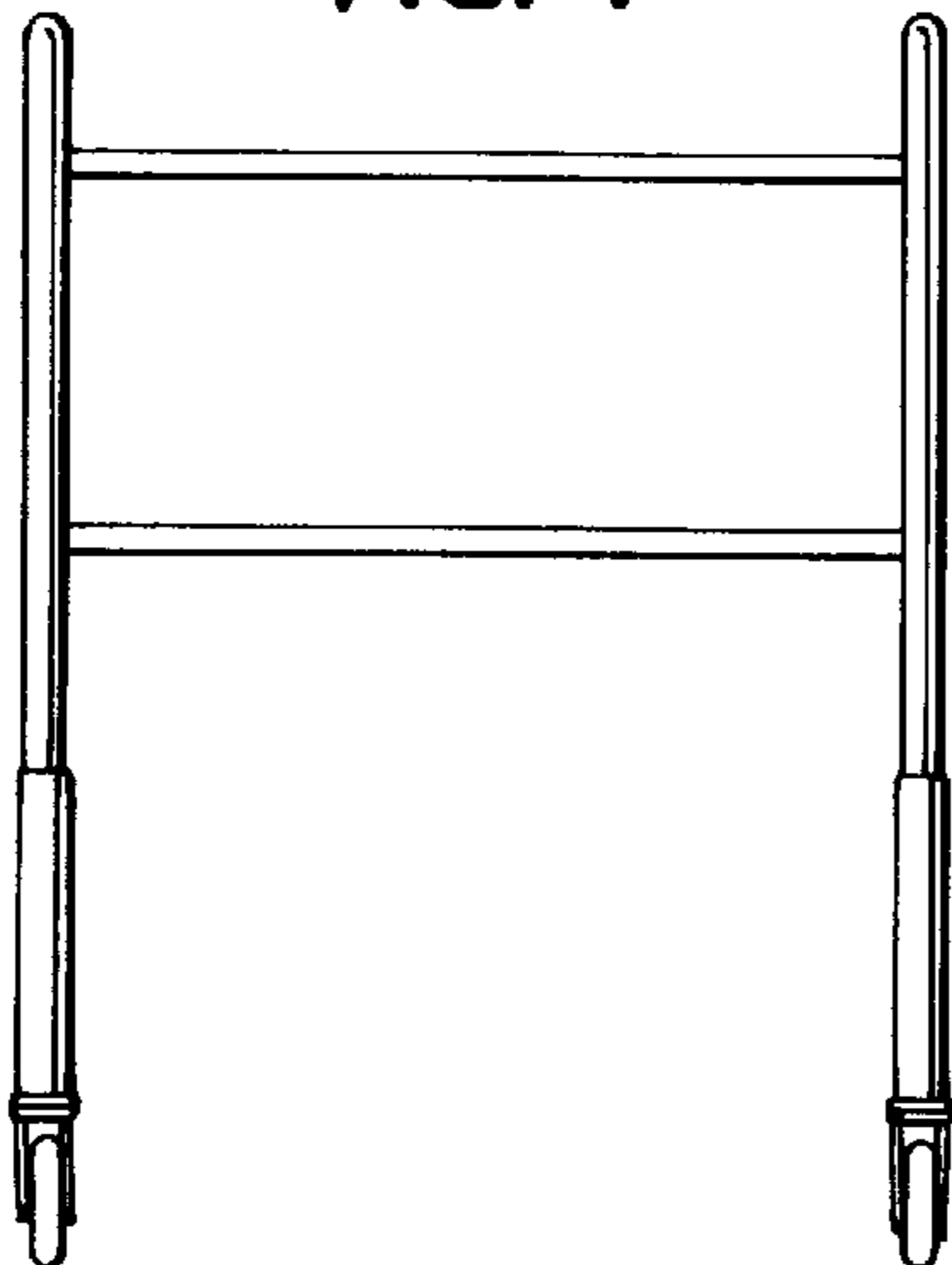

FIG. 5

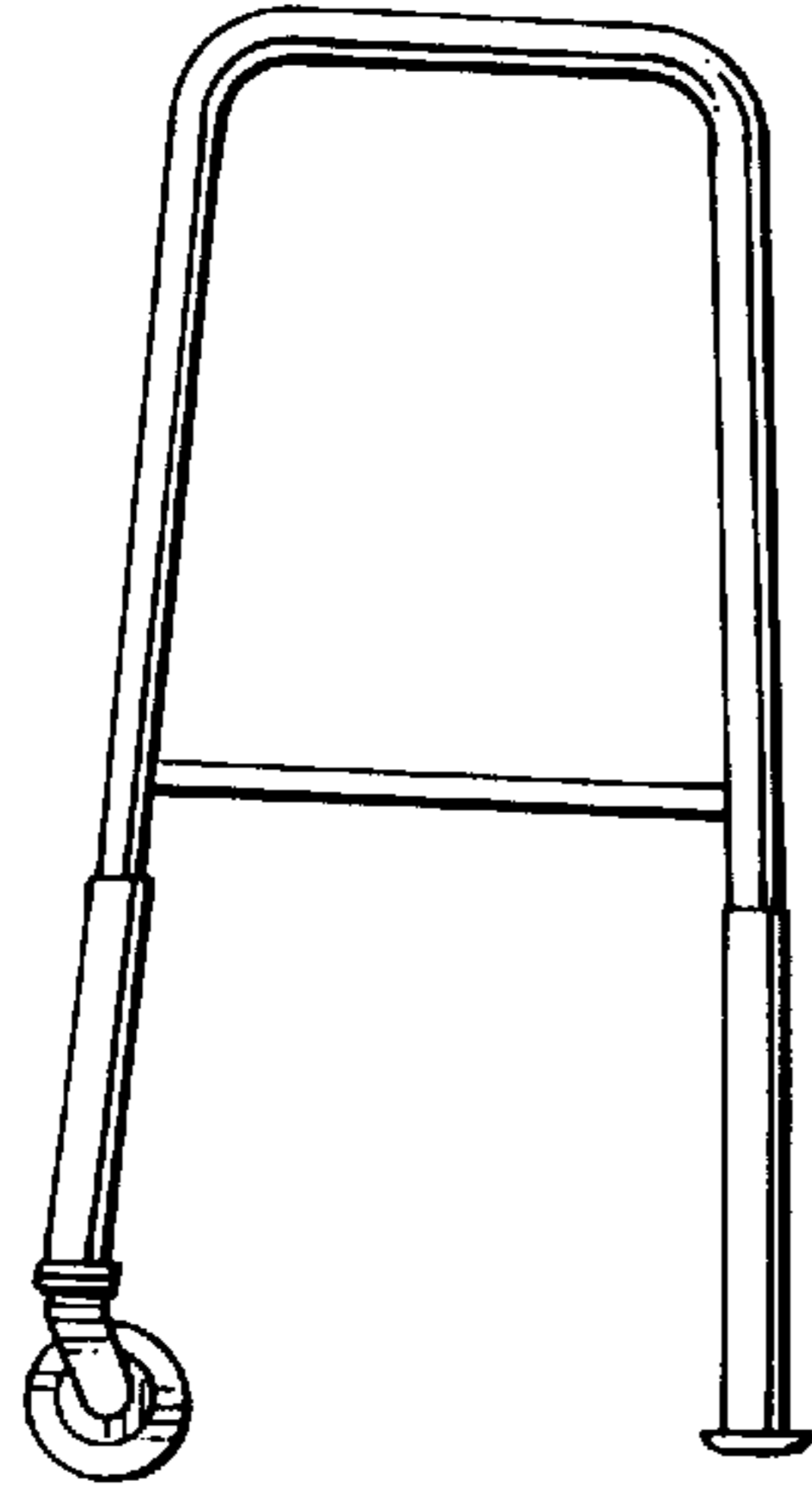

FIG. 6

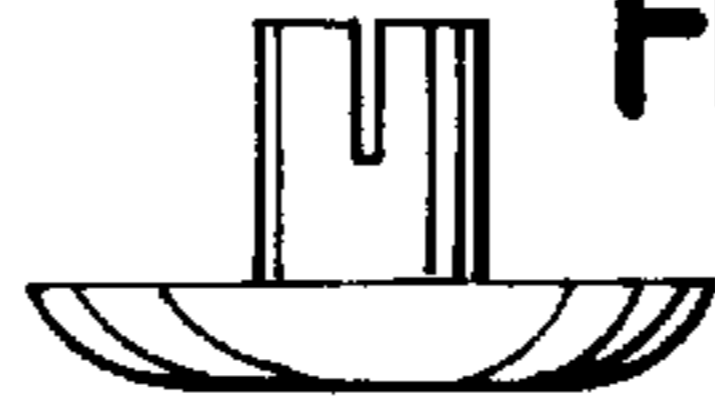

FIG. 7

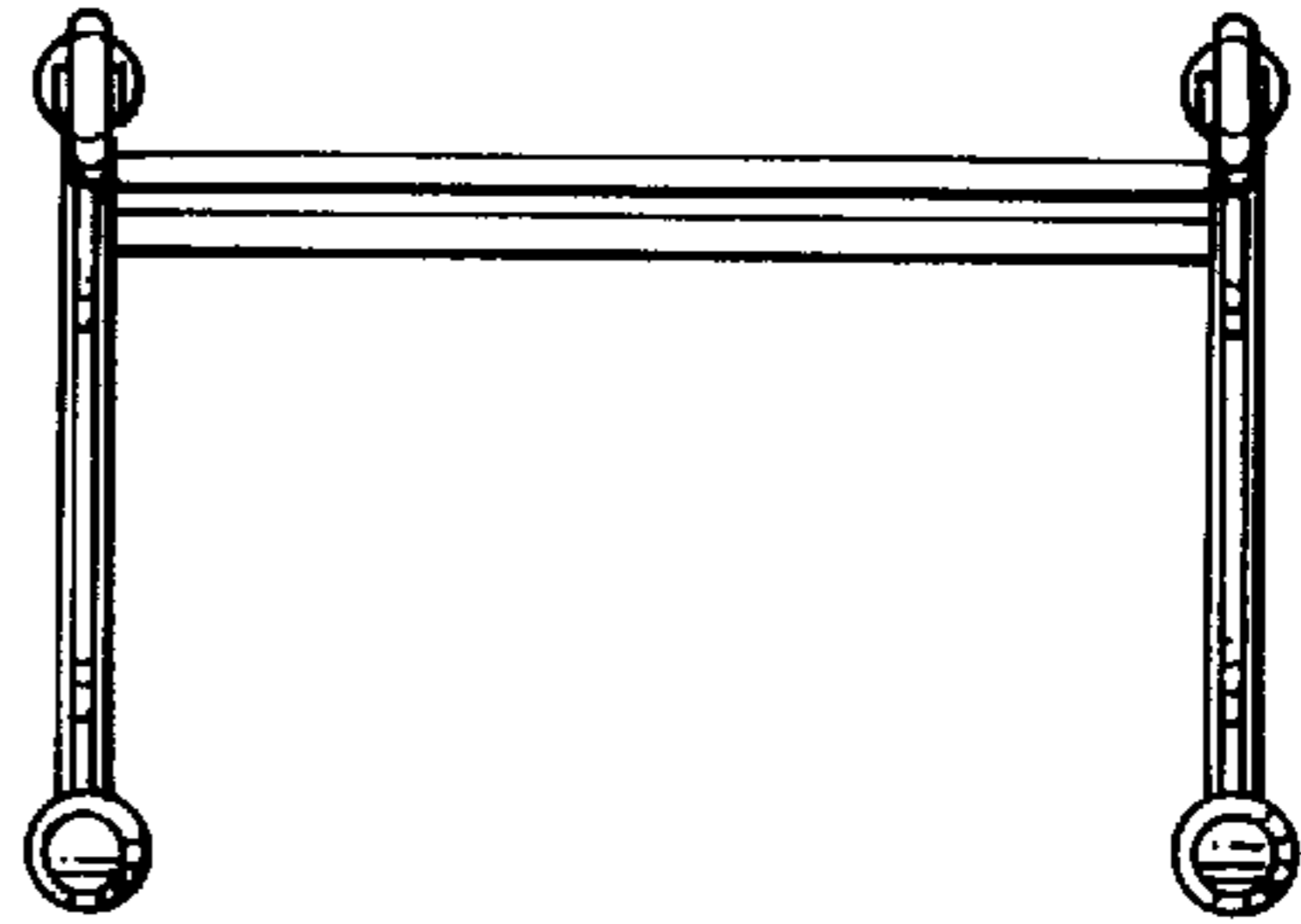

FIG. 8

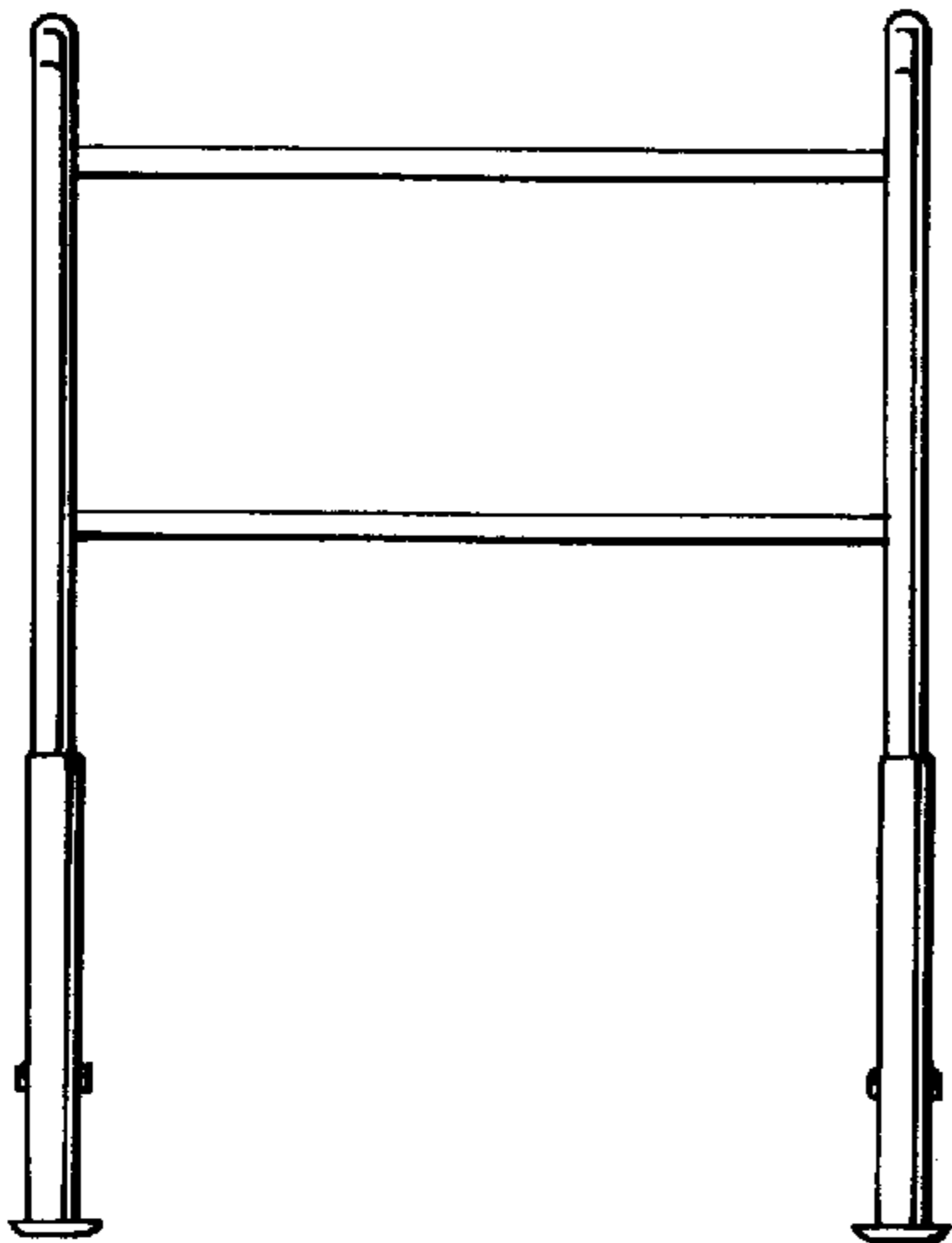

FIG. 9



FIG. 10

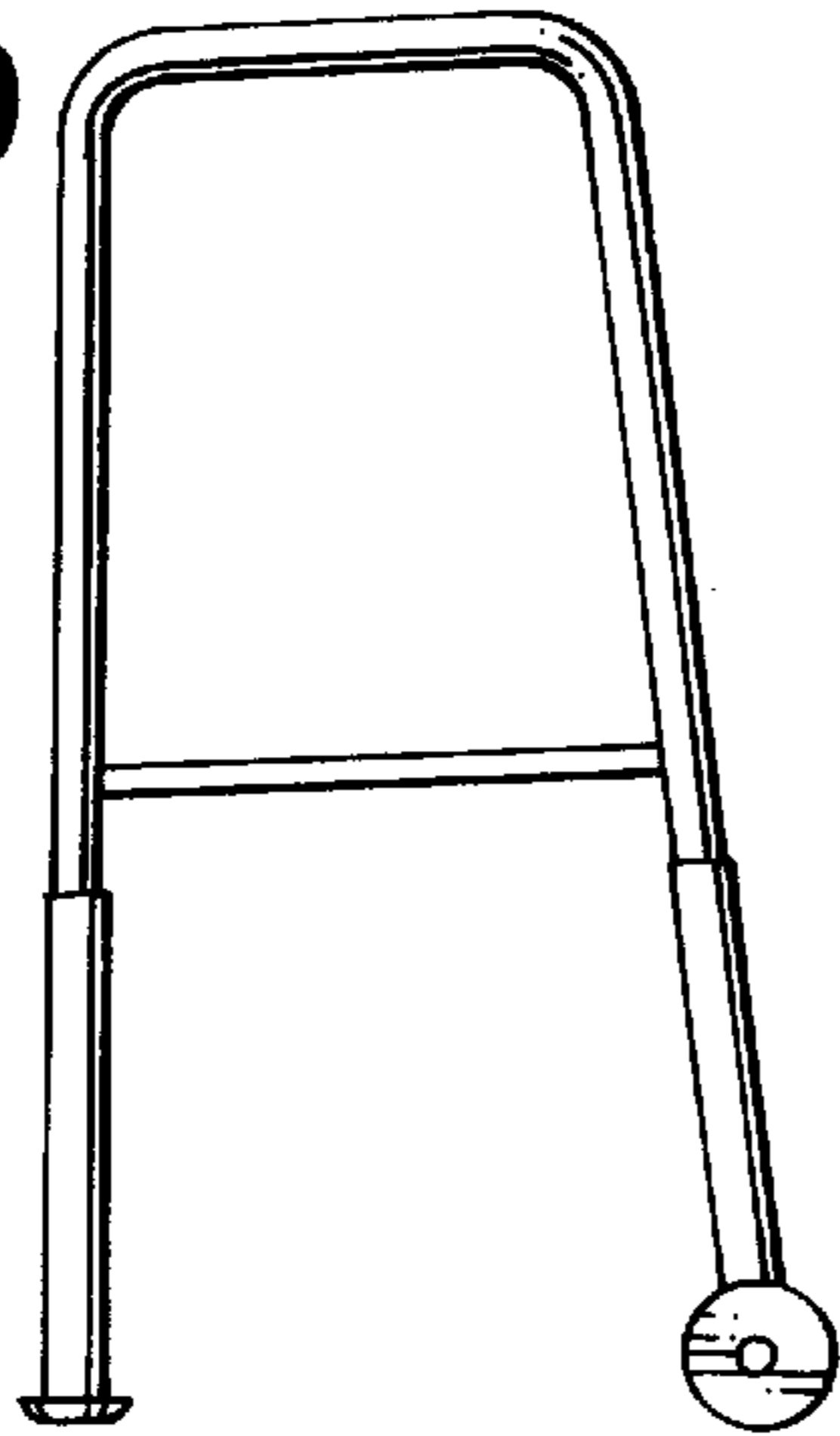

FIG. 11

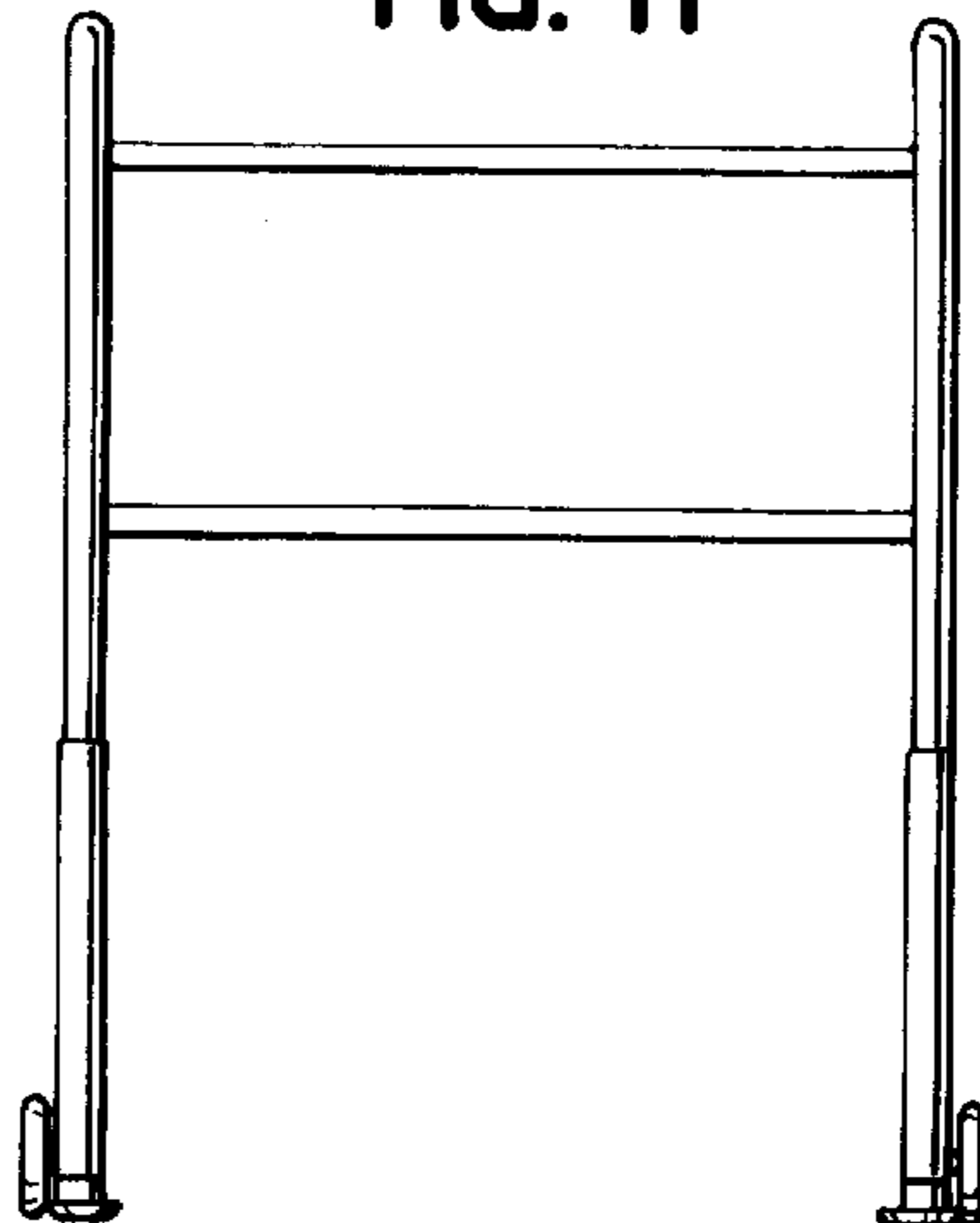

FIG. 12

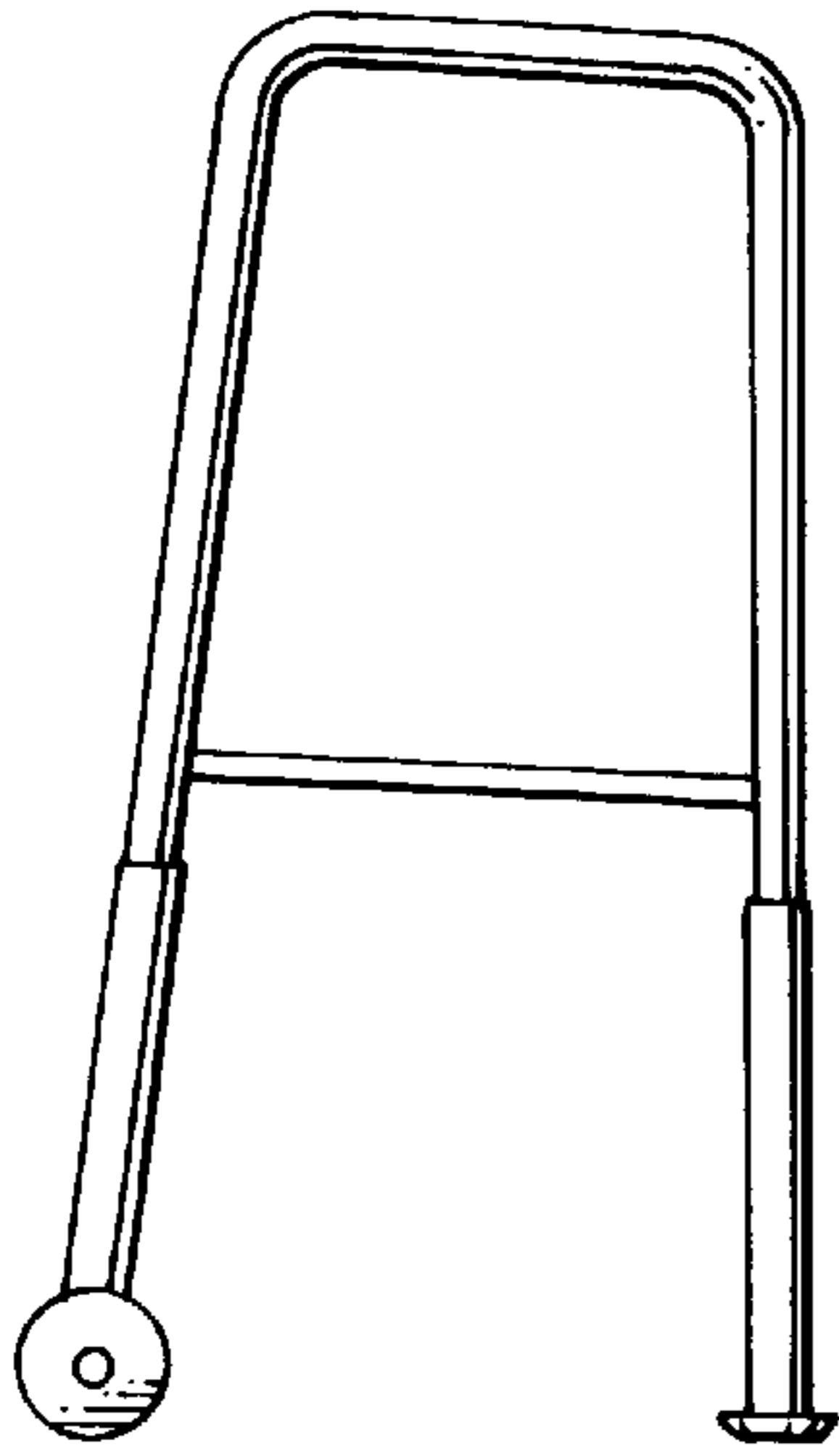

FIG. 13

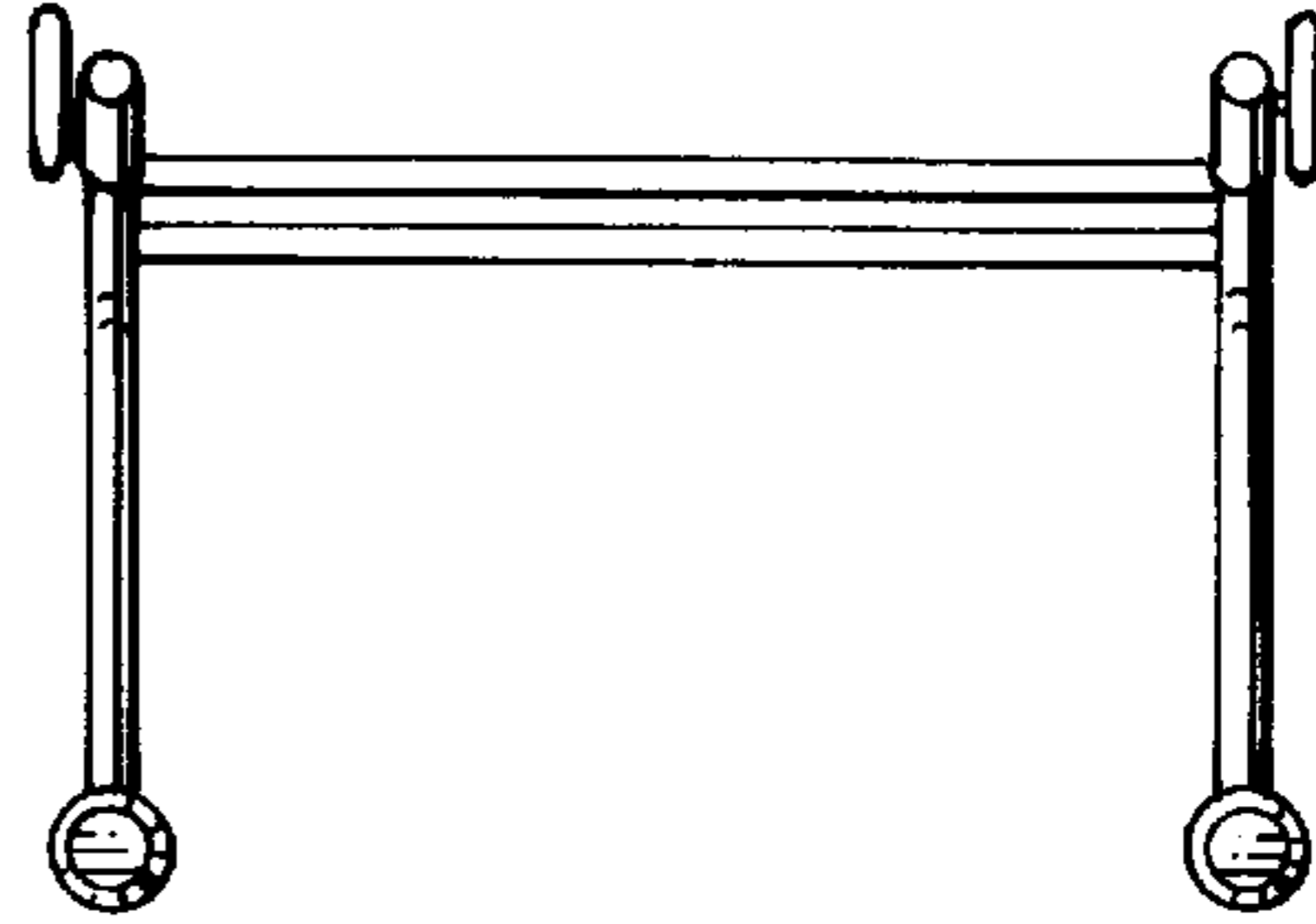

FIG. 14

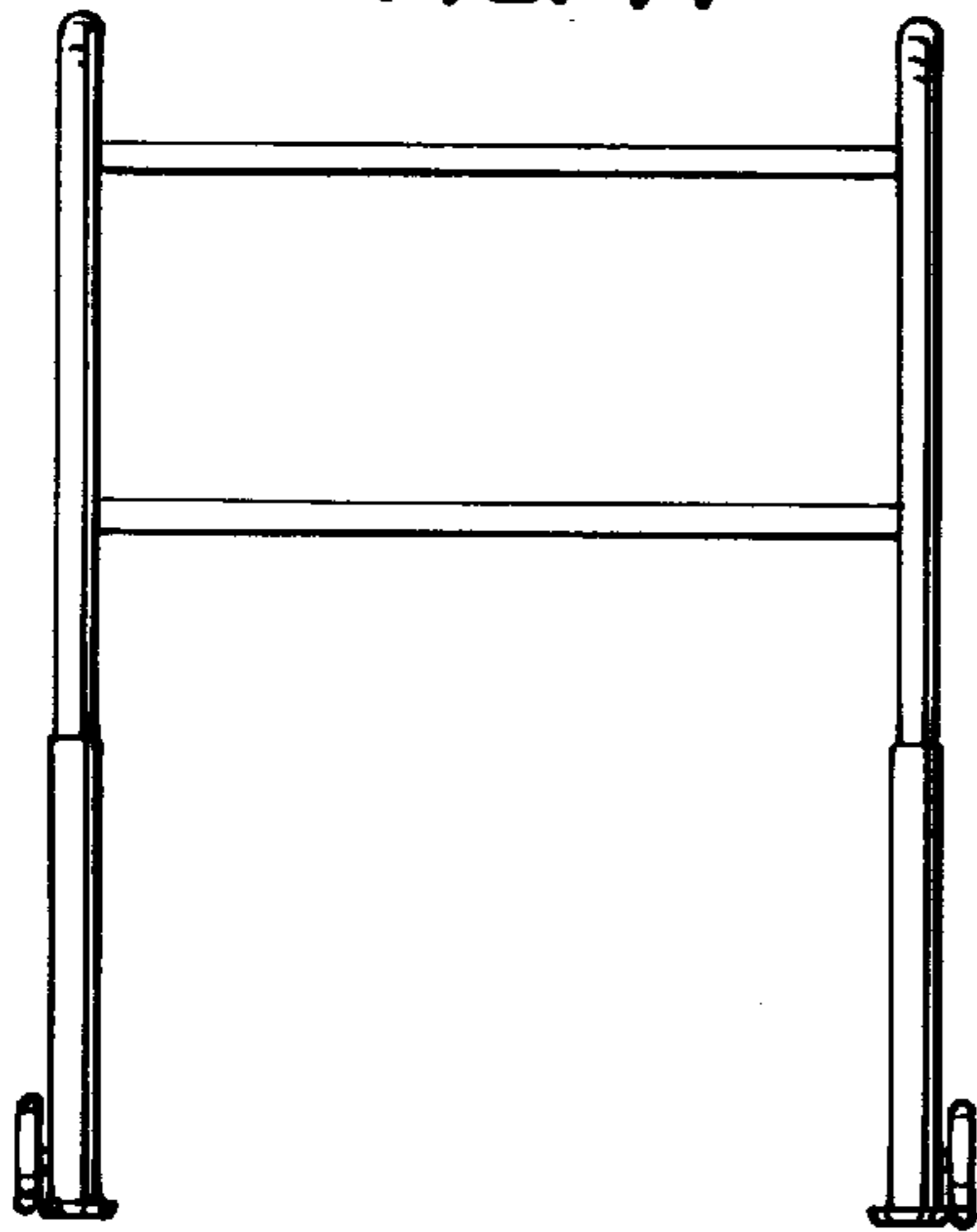

FIG. 15



FIG. 16

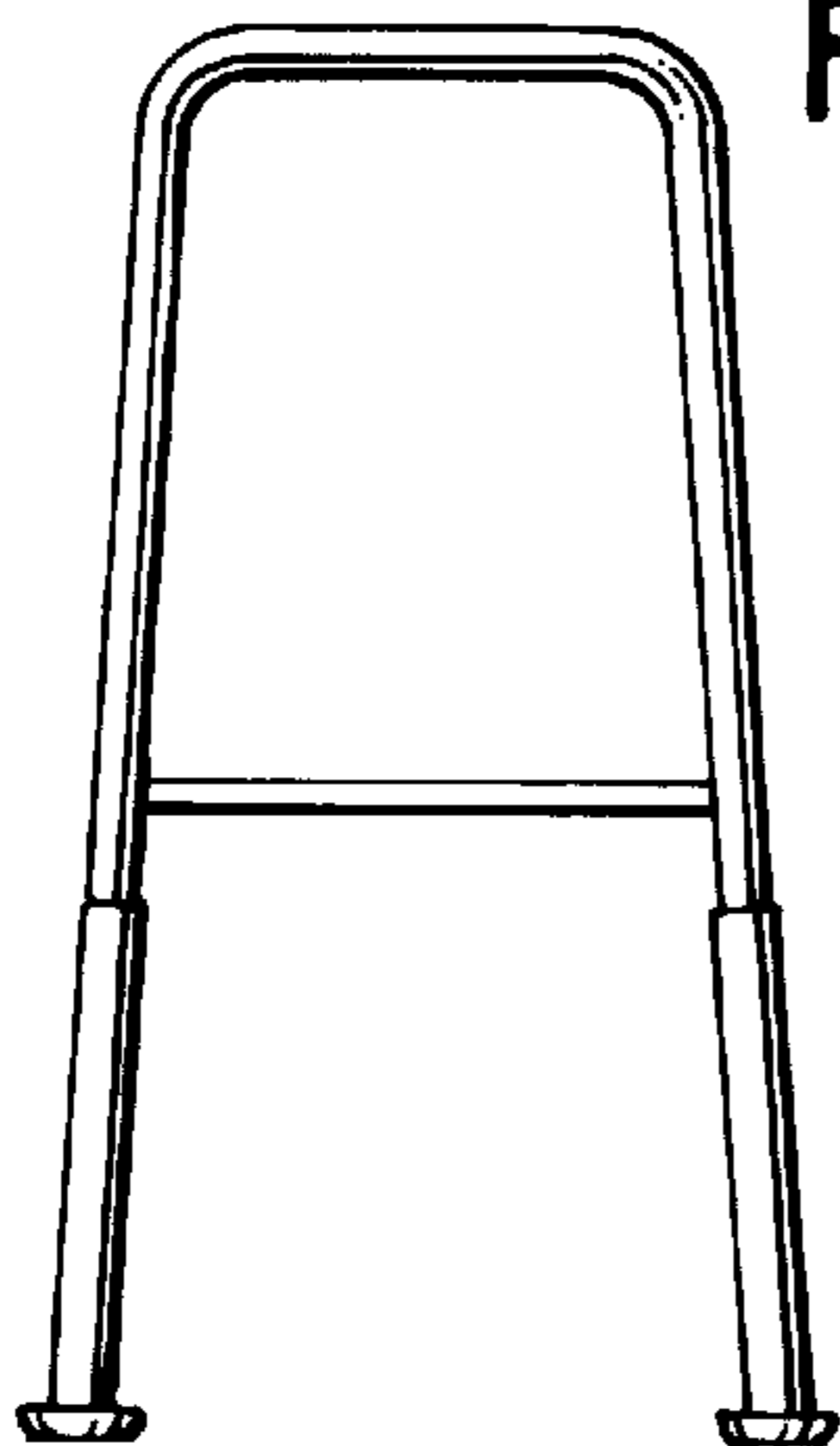

FIG. 17

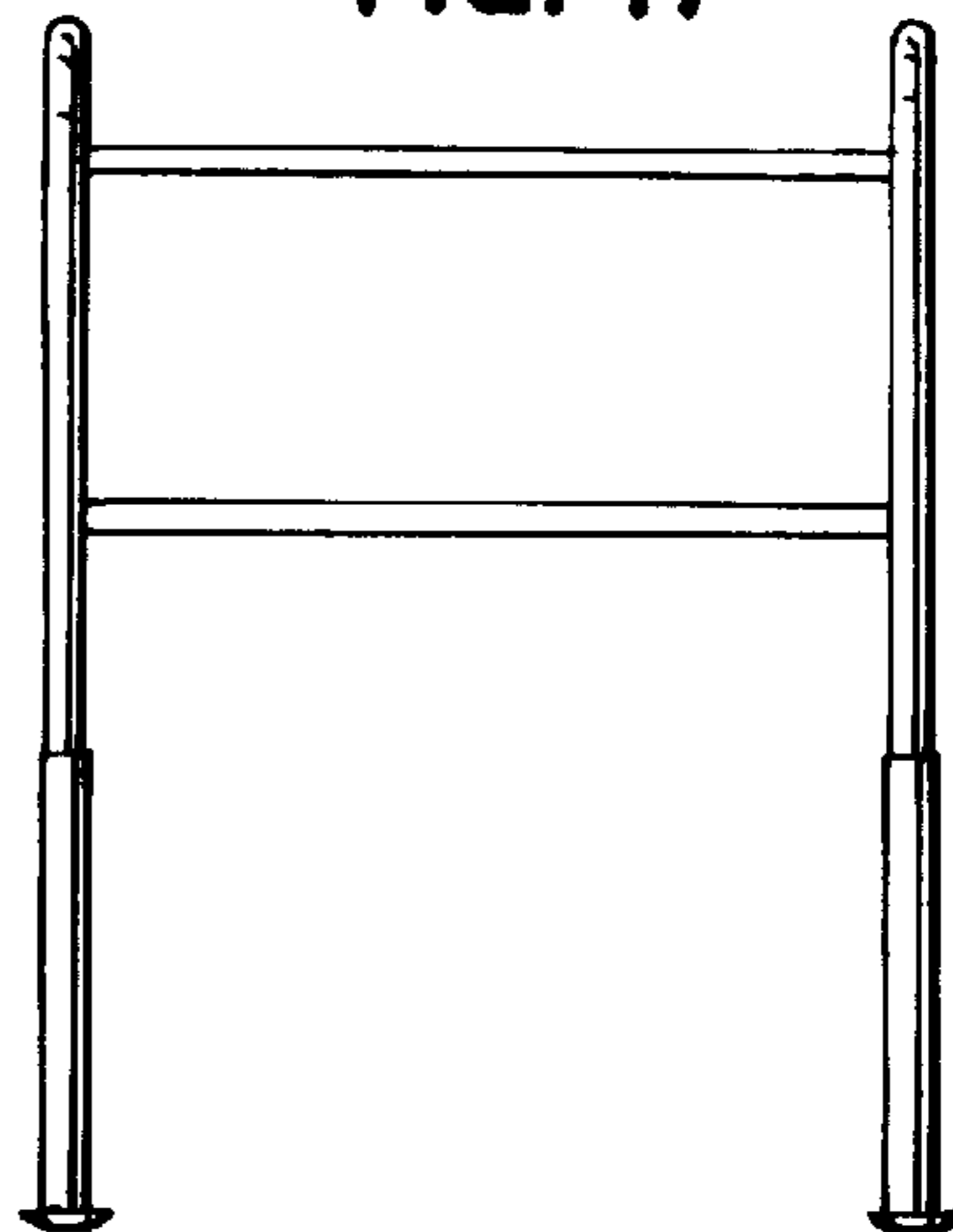

FIG. 18

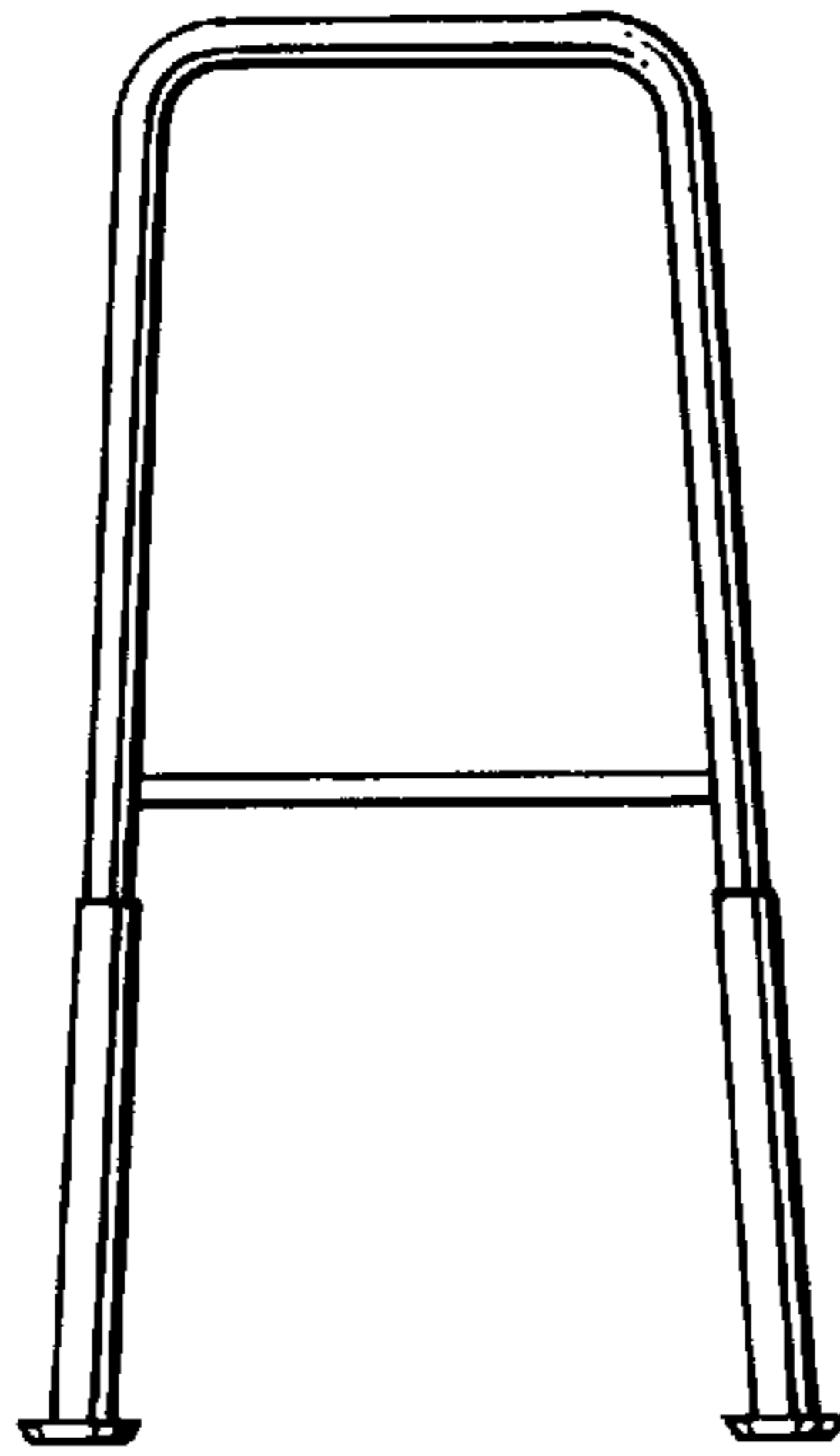

FIG. 19

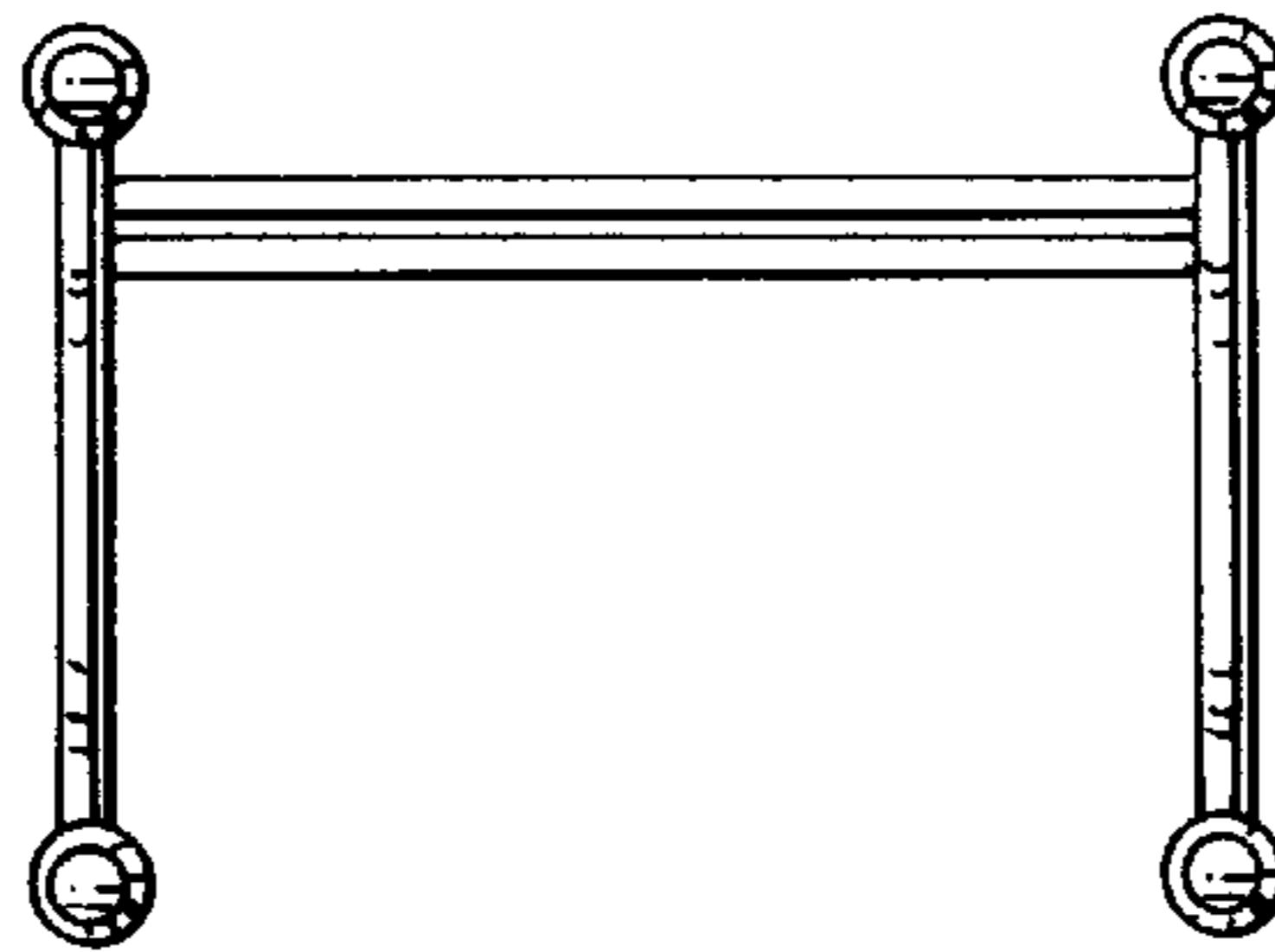

FIG. 20

