



US00D404312S

**United States Patent** [19]  
**Granai**

[11] **Patent Number: Des. 404,312**

[45] **Date of Patent: \*\*Jan. 19, 1999**

[54] **COMBINED BOTTLE AND CLOSURE**

[75] Inventor: **Robert Granai**, Paris, France

[73] Assignee: **Guerlain S.A.**, Paris, France

[\*\*] Term: **14 Years**

[21] Appl. No.: **86,443**

[22] Filed: **Apr. 13, 1998**

[51] **LOC (6) Cl.** ..... **09-01**

[52] **U.S. Cl.** ..... **D9/558; D9/449; D9/545**

[58] **Field of Search** ..... D9/500, 503, 529,  
D9/545, 556, 449, 454, 443, 539, 540,  
558, 549, 337, 517; 215/382, 383, 384,  
237, 244, 293, 306

[56] **References Cited**

**U.S. PATENT DOCUMENTS**

D. 196,149	8/1963	Knies	.....	D9/545
D. 293,534	1/1988	Bolich	.....	D7/511
D. 318,421	7/1991	Bertholon	.....	D9/545
D. 342,452	12/1993	Monaghan	.....	D9/454
D. 384,887	10/1997	Rafflin	.....	D9/500

D. 390,470	2/1998	Mahlmann et al.	.....	D9/545
4,534,483	8/1985	Kassis et al.	.....	215/306
5,582,314	12/1996	Quinn et al.	.....	215/237

*Primary Examiner*—Lucy Lieberman  
*Attorney, Agent, or Firm*—Lawrence E. Apolzon, Esq.;  
Fross Zelnick Lehrman and Zissu, P.C.

[57] **CLAIM**

The ornamental design for a combined bottle and closure, as shown and described.

**DESCRIPTION**

FIG. 1 is a perspective view of a combined bottle and closure showing my new design with the closure closed;  
FIG. 2 is a side view;  
FIG. 3 is a front elevation, the rear elevation is a mirror image thereto;  
FIG. 4 is the other side view;  
FIG. 5 is a top view;  
FIG. 6 is a bottom view;  
FIG. 7 is a top view with the closure open; and,  
FIG. 8 is a perspective view with the closure open.

**1 Claim, 3 Drawing Sheets**

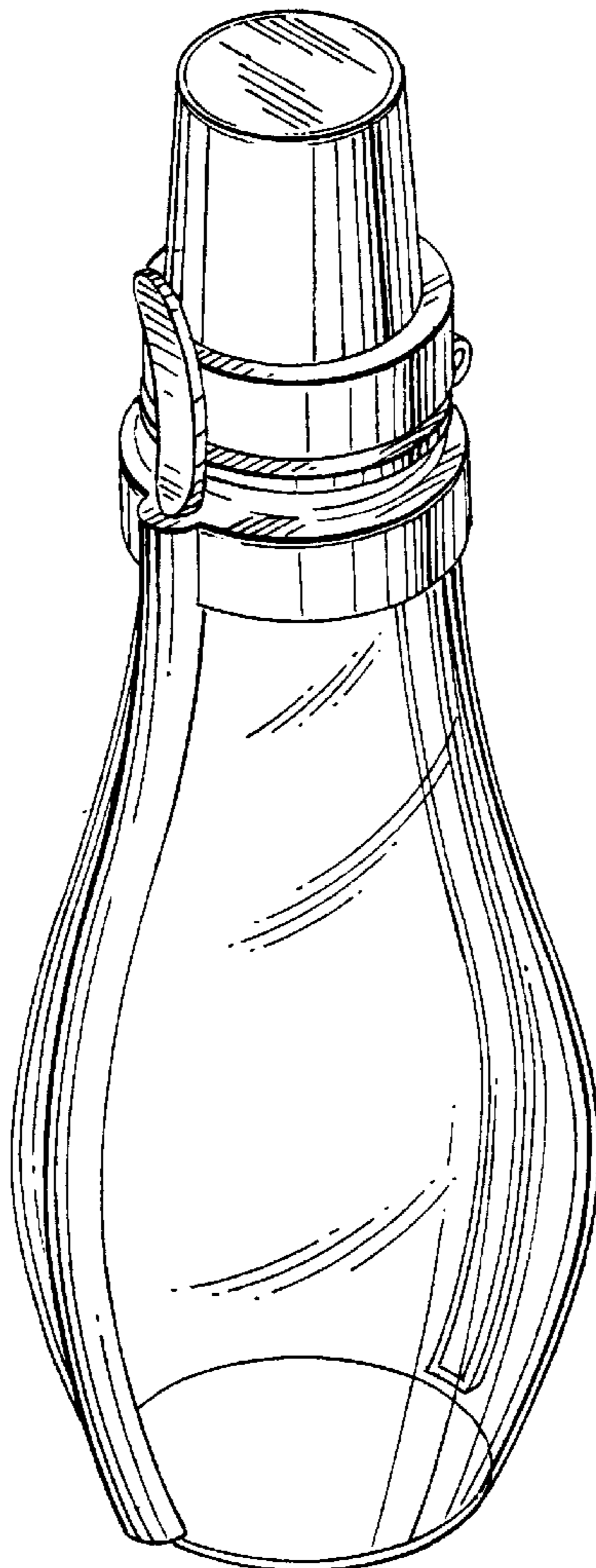

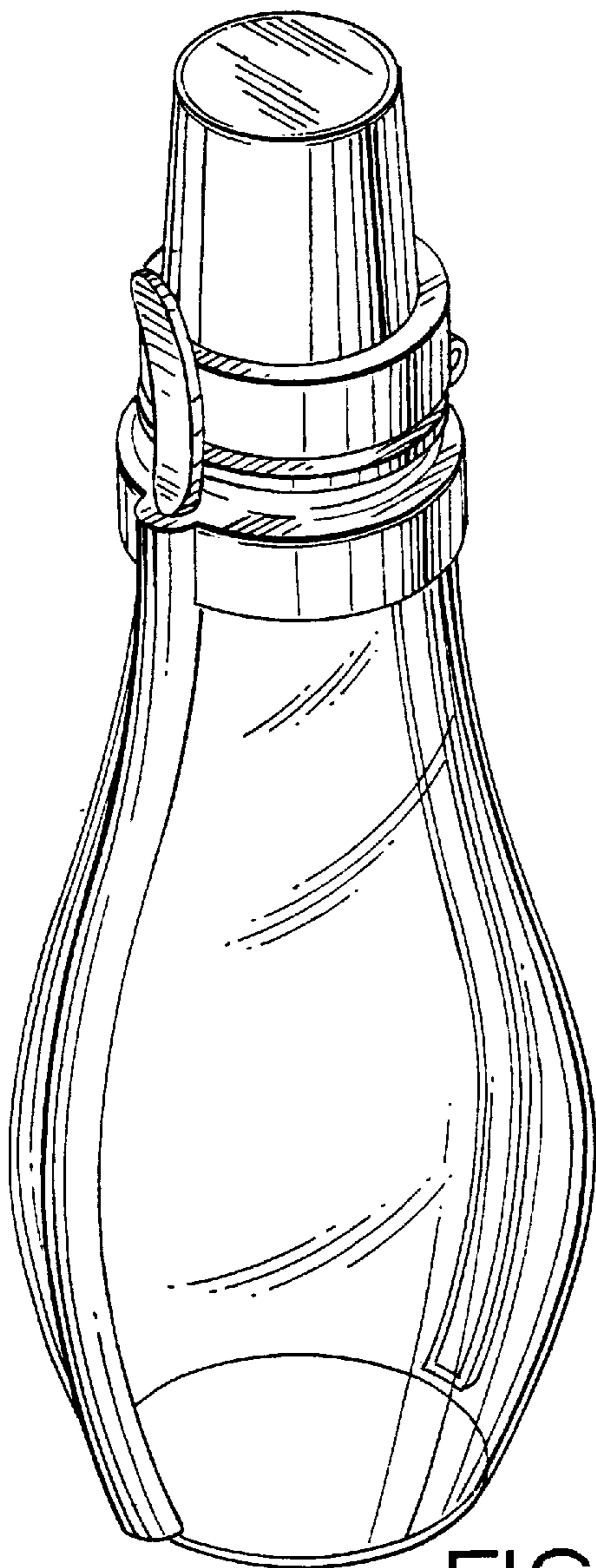

FIG. 1

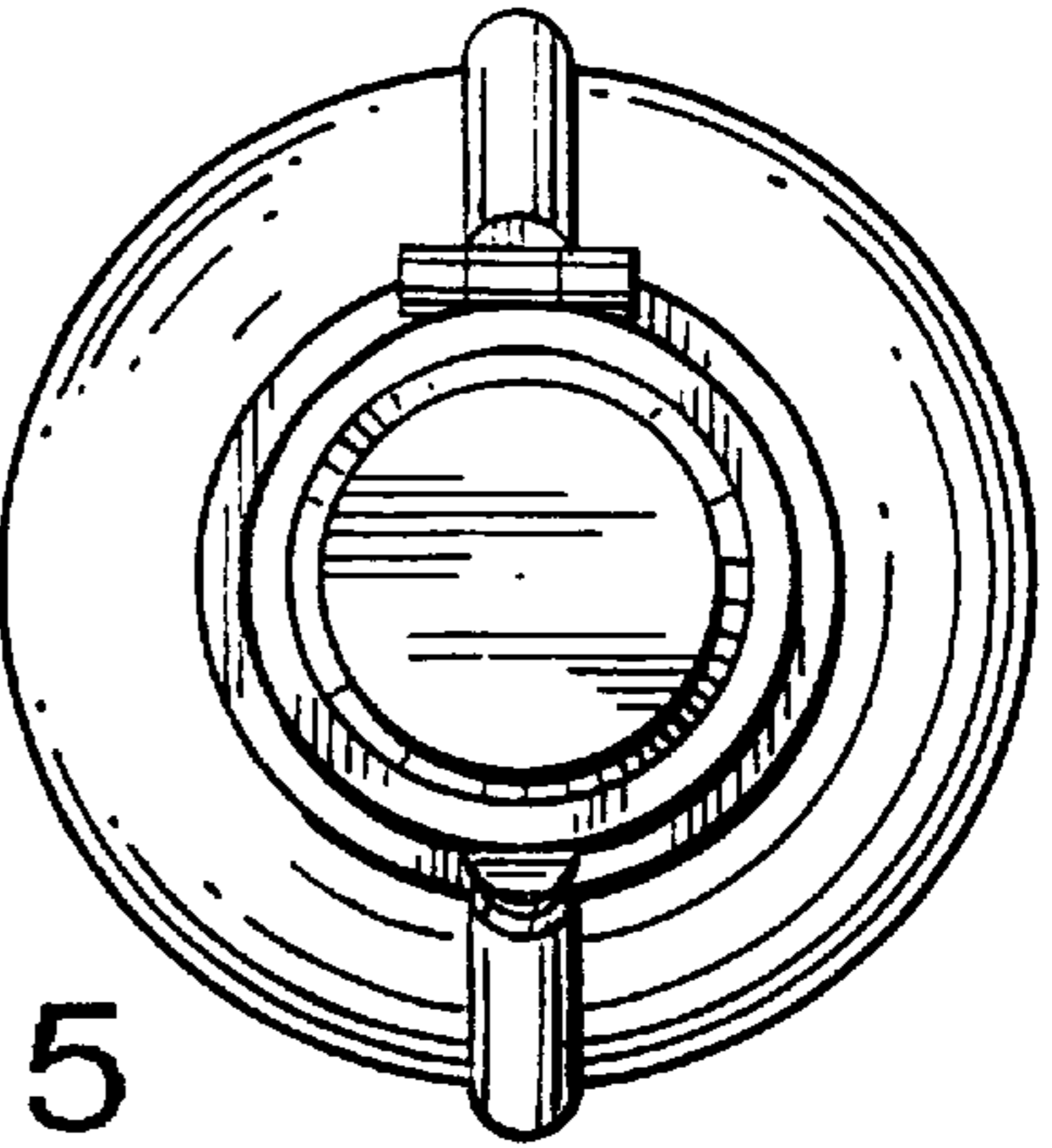

FIG. 5

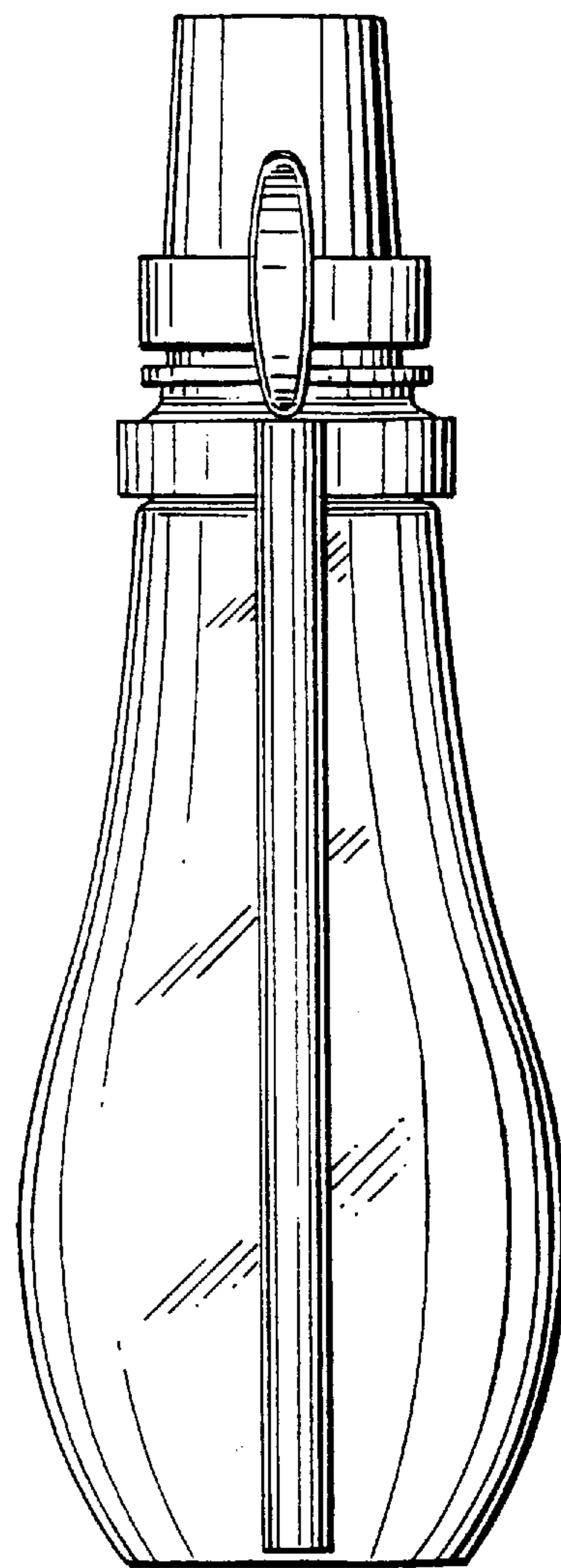

FIG. 2

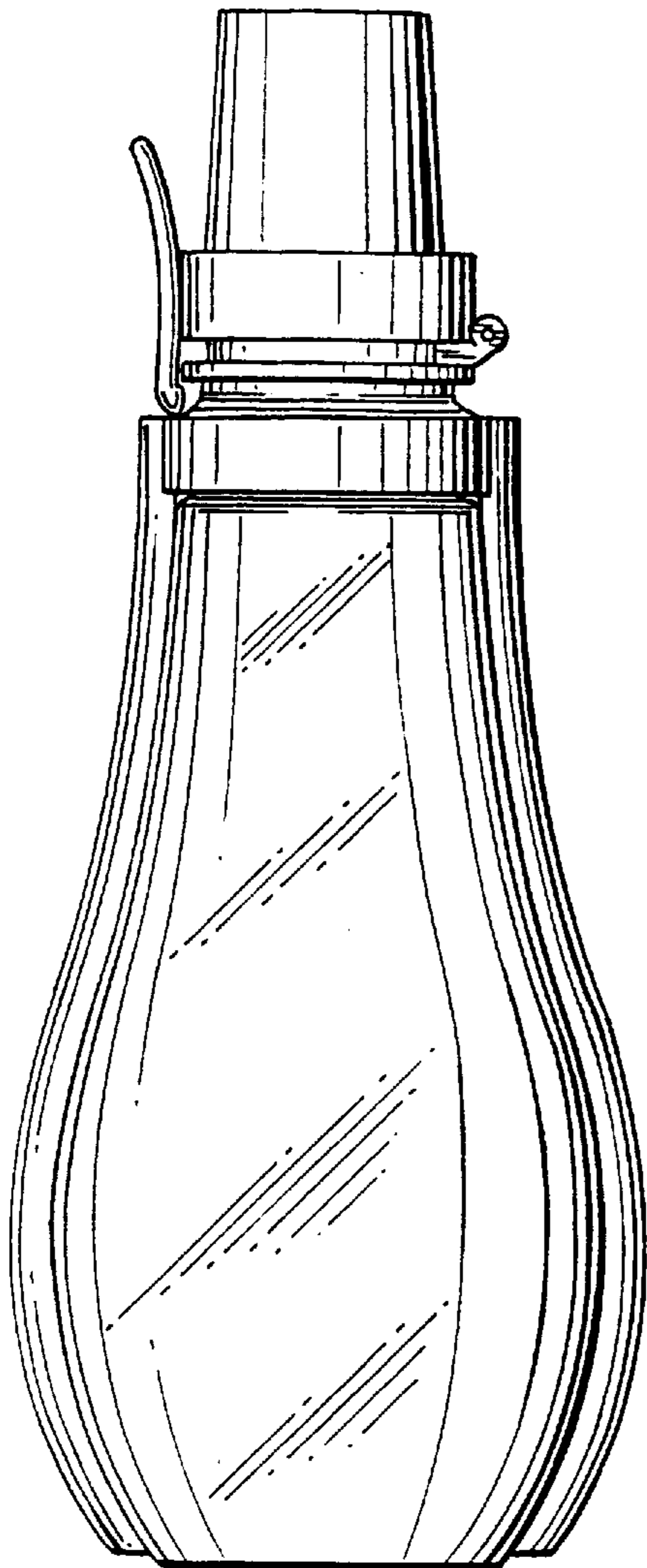

FIG. 3

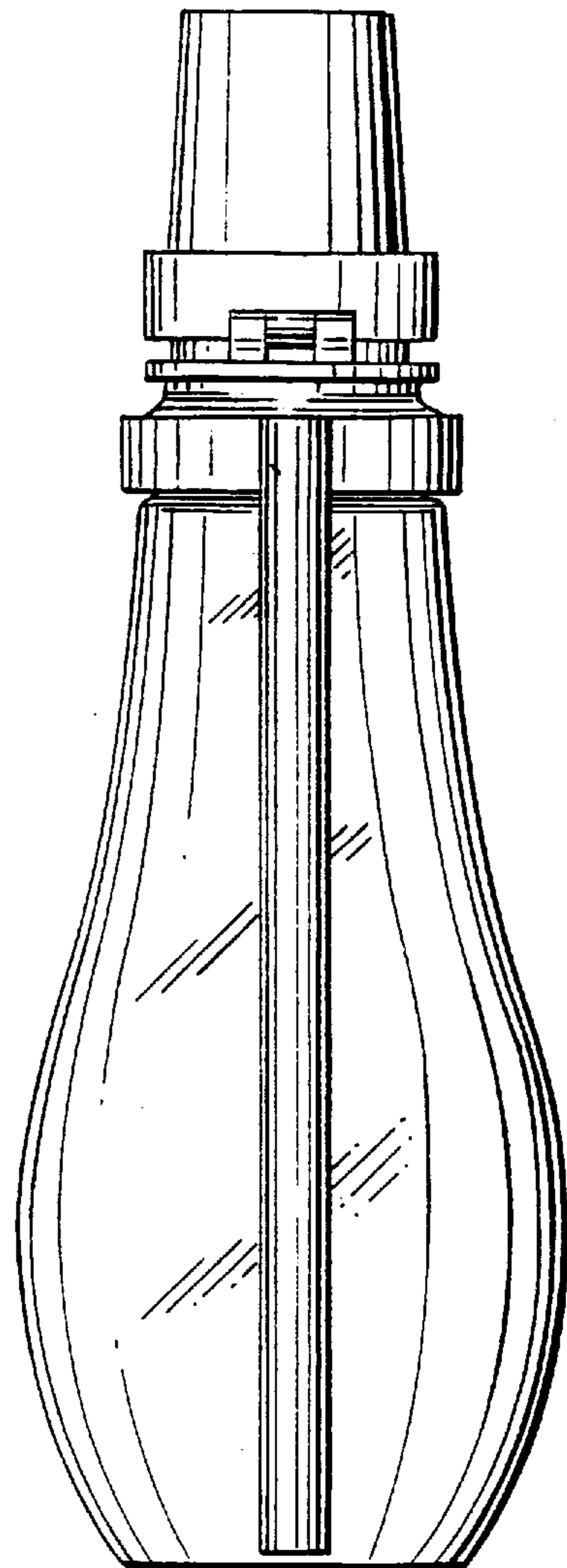

FIG. 4

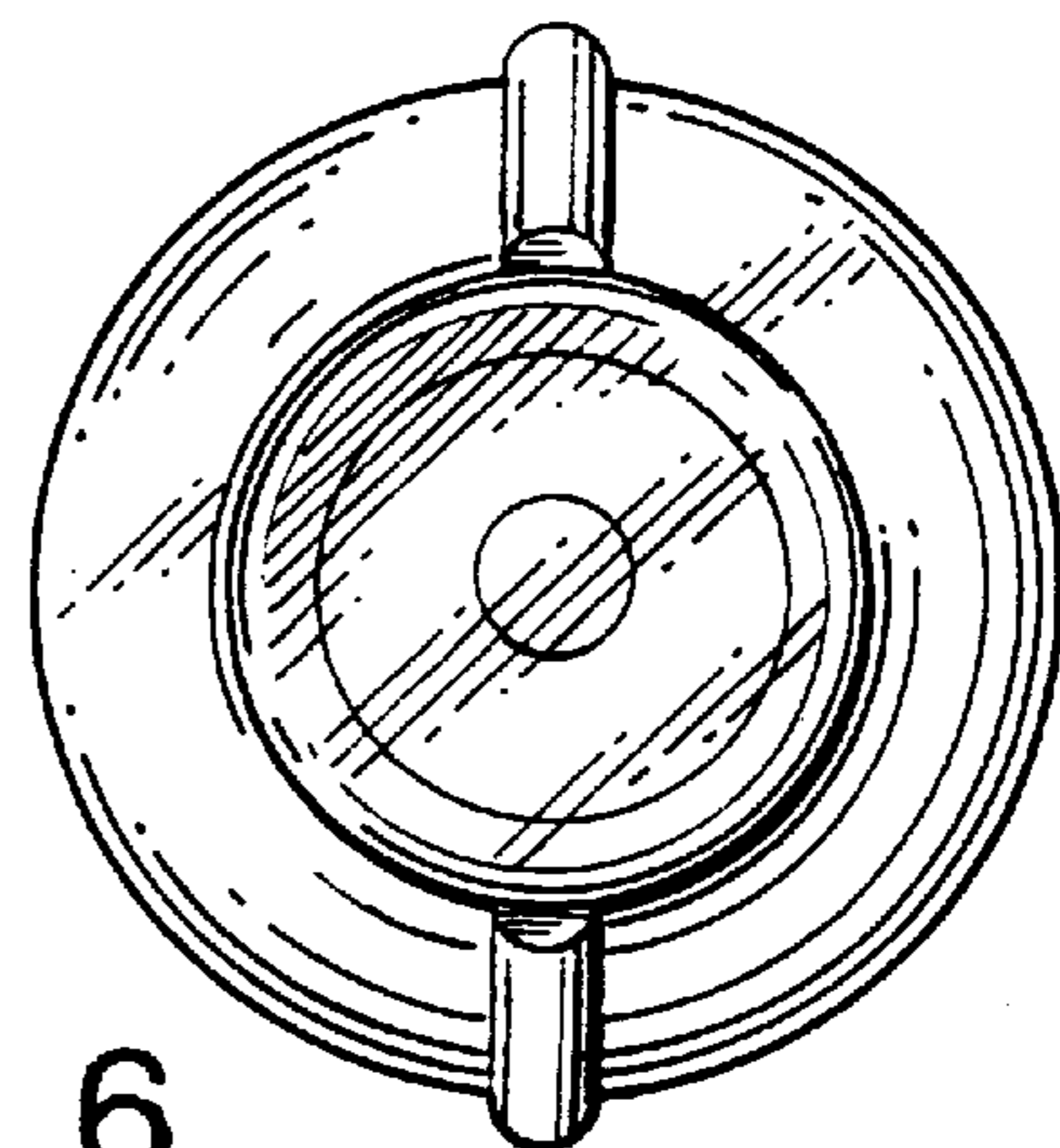

FIG. 6

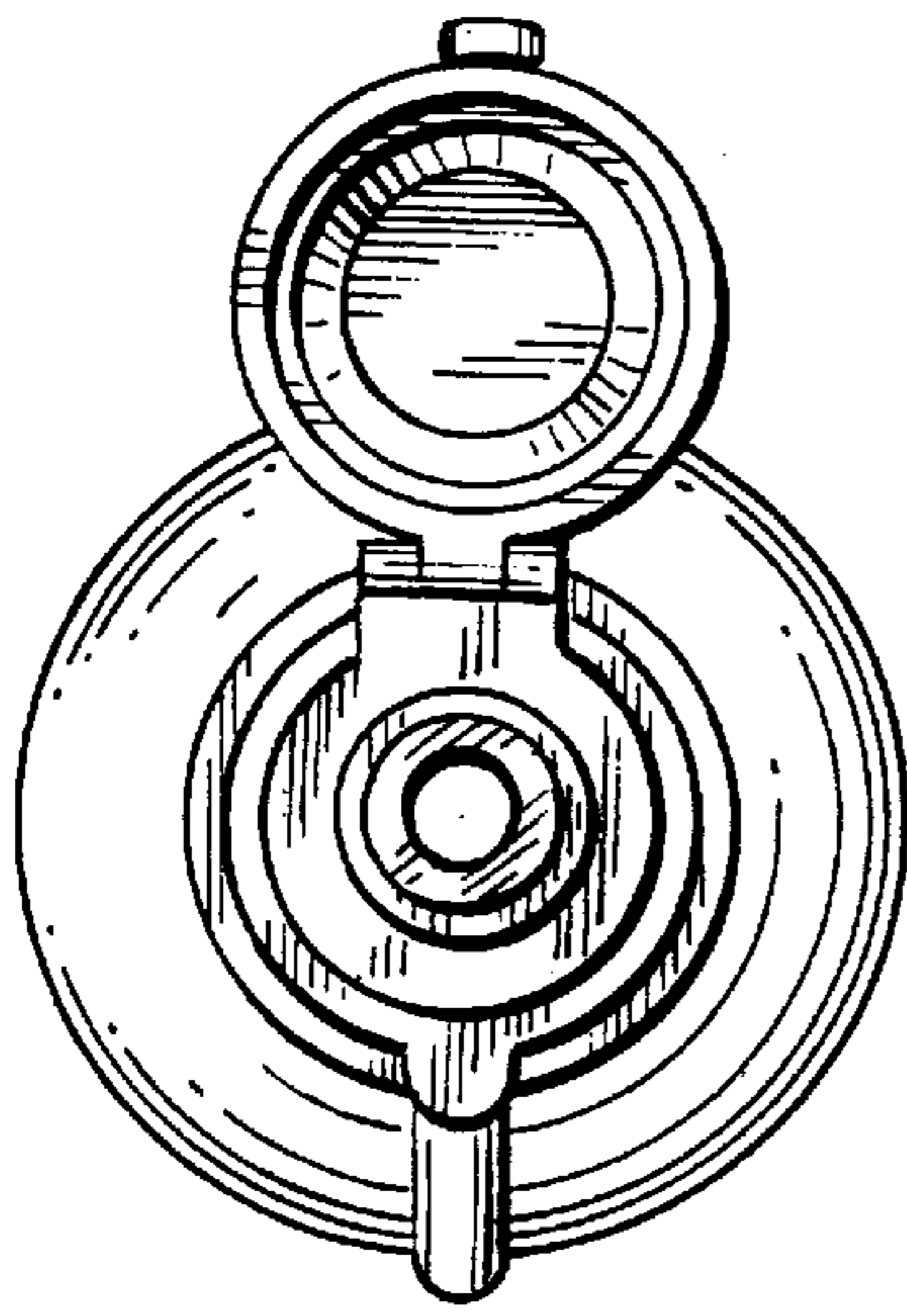

FIG. 7

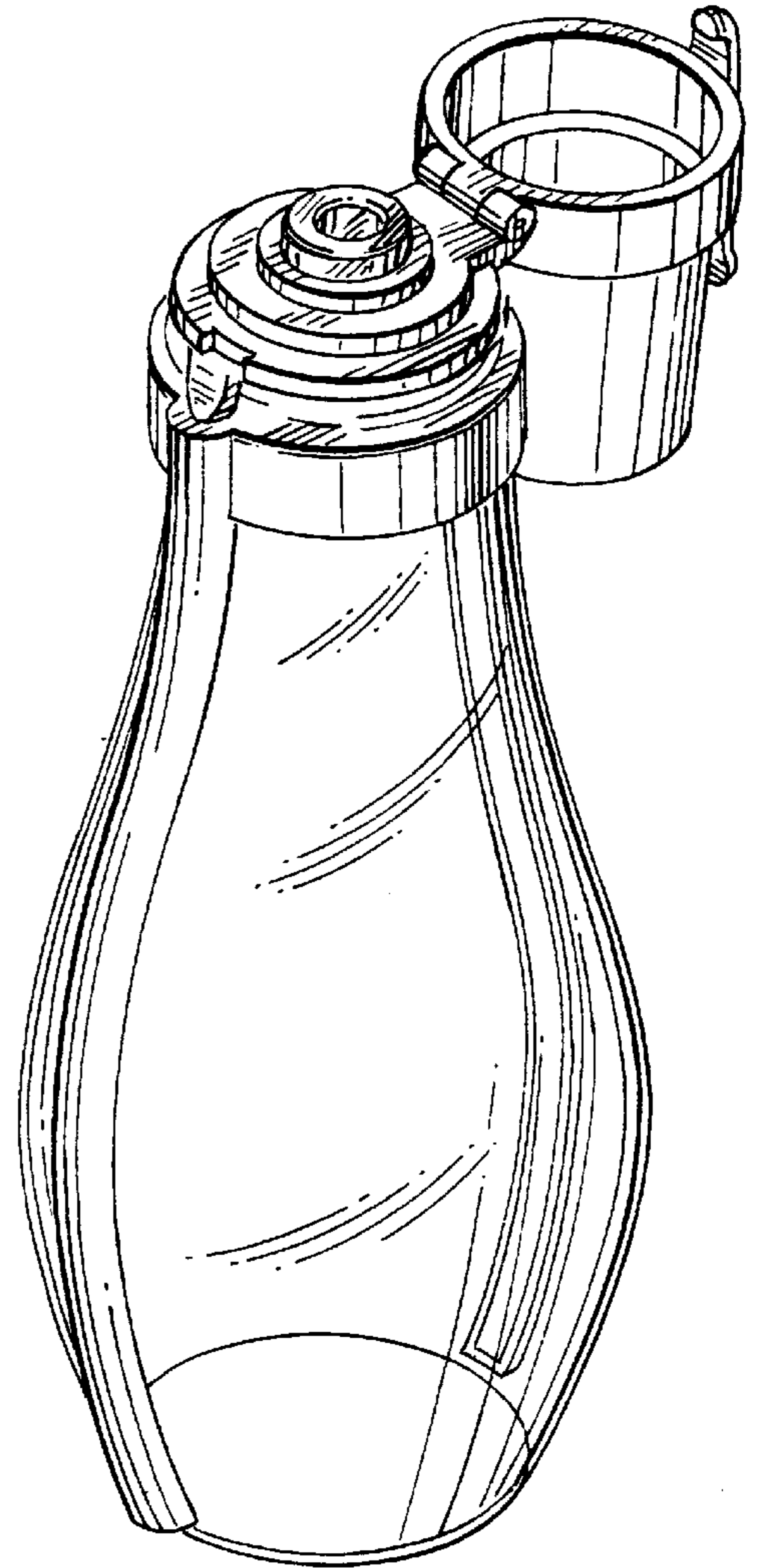

FIG. 8