

US00D404246S

United States Patent [19]

Arita et al.

[11] Patent Number: Des. 404,246

[45] Date of Patent: **Jan. 19, 1999

[54] DRY MILL

[75] Inventors: Toyomi Arita, Osaka; Shigehiro Uemura, Kyoto; Kazuo Takada, Nara, all of Japan

[73] Assignee: Sanyo Electric Co., Ltd., Osaka, Japan

[**] Term: 14 Years

[21] Appl. No.: 74,318

[22] Filed: Jul. 8, 1997

[30] Foreign Application Priority Data

Jan. 8, 1997 [JP] Japan 9-273

[51] LOC (6) Cl. 07-02

[52] U.S. Cl. D7/372

[58] Field of Search D7/372-374, 383-384; 241/DIG. 17, 152.1, 95, 274, 82.1, 83, 277, 285.1

[56] References Cited

U.S. PATENT DOCUMENTS

- D. 242,892 1/1977 Brown et al. D7/155
- D. 269,489 6/1983 Akita .
- D. 352,422 11/1994 Bigelow D7/372

- D. 386,648 11/1997 Kibbe D7/372
- D. 391,441 3/1998 Tanaka et al. D7/372
- D. 394,183 5/1998 Arita et al. D7/384

FOREIGN PATENT DOCUMENTS

886073 9/1993 Japan .

Primary Examiner—Ruth McInroy
Attorney, Agent, or Firm—Loeb & Loeb LLP

[57] CLAIM

The ornamental design for a dry mill, as shown and described.

DESCRIPTION

FIG. 1 is a front perspective view of a dry mill showing our new design, the dry mill includes a battery that is fragmentarily shown in broken lines for illustrative purposes only and forms no part of the claimed design; FIG. 2 is a front view of FIG. 1, a rear view is omitted since it is symmetrical with the front view; FIG. 3 is a top view thereof; FIG. 4 is a bottom view thereof; FIG. 5 is a left side view thereof; and, FIG. 6 is a right side view thereof.

1 Claim, 5 Drawing Sheets

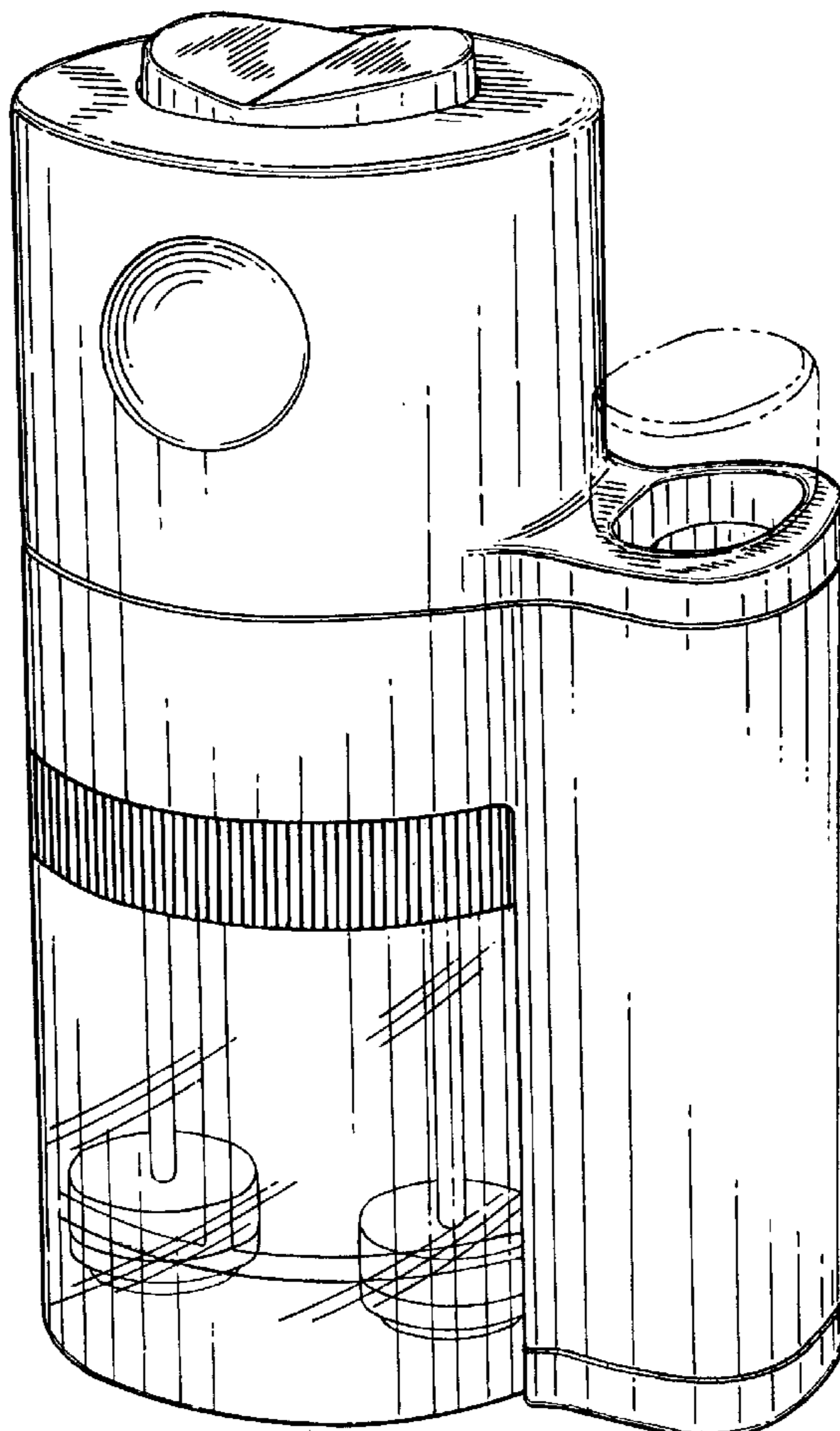

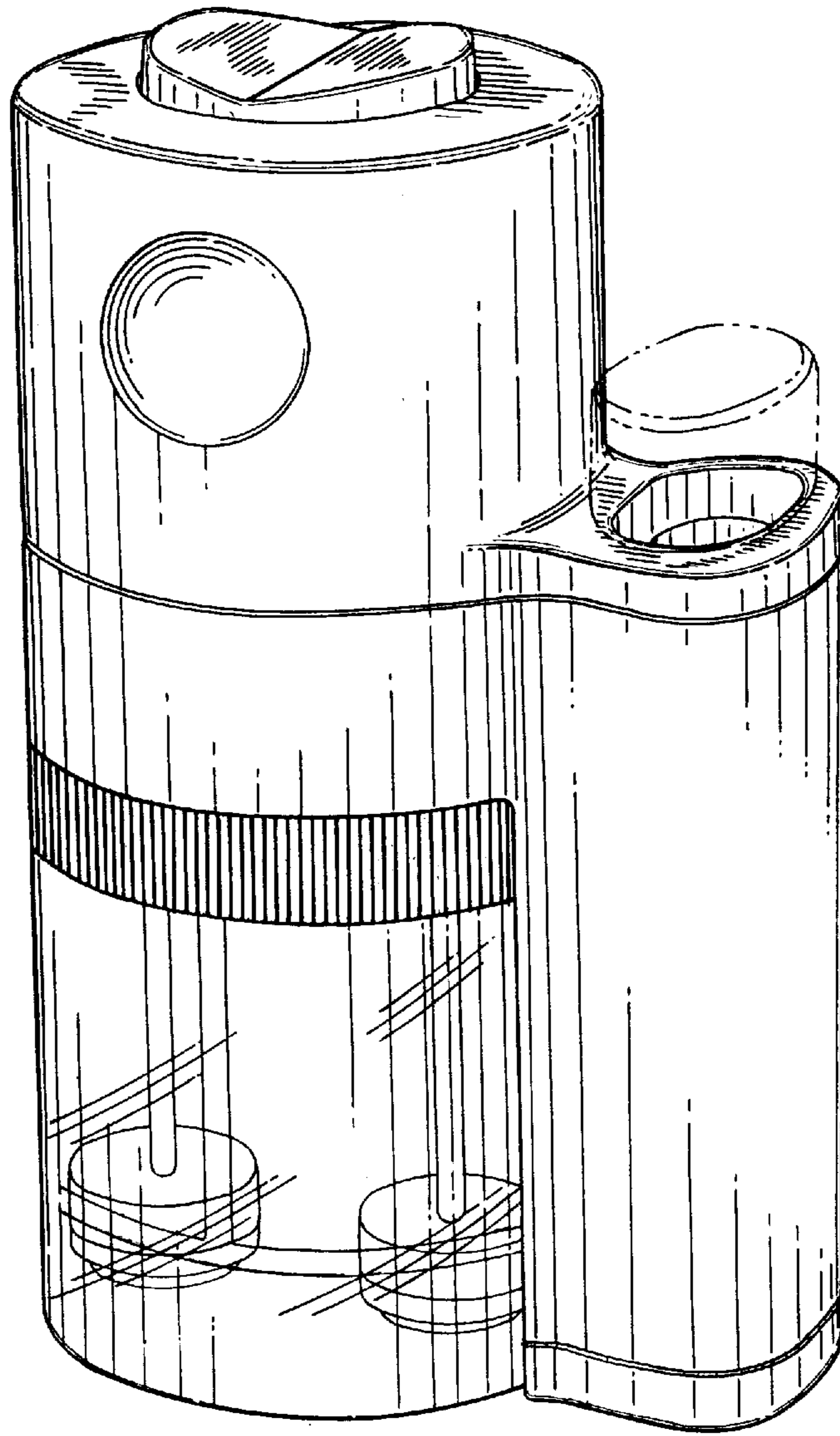

FIG. 1

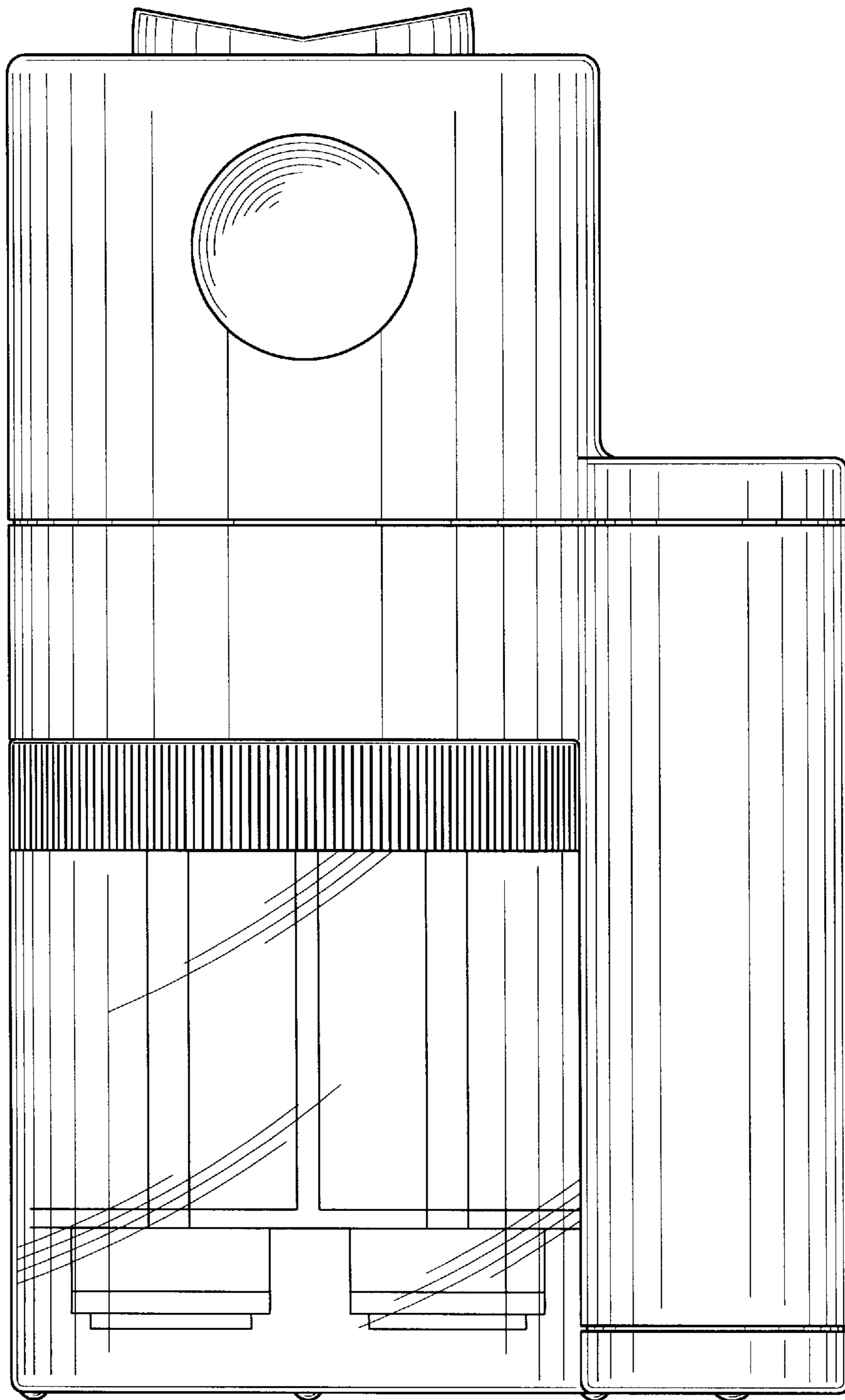

FIG. 2

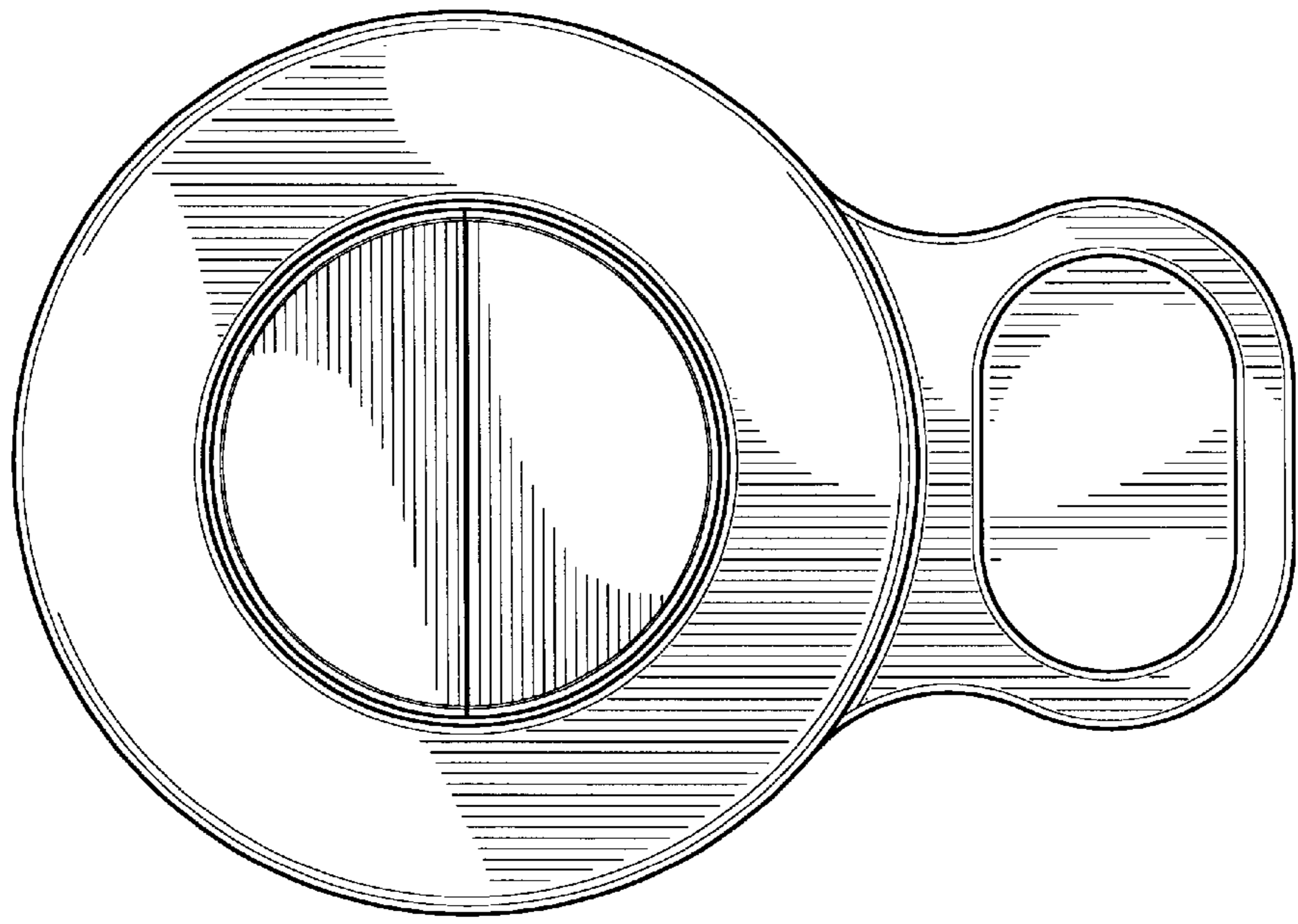

FIG. 3

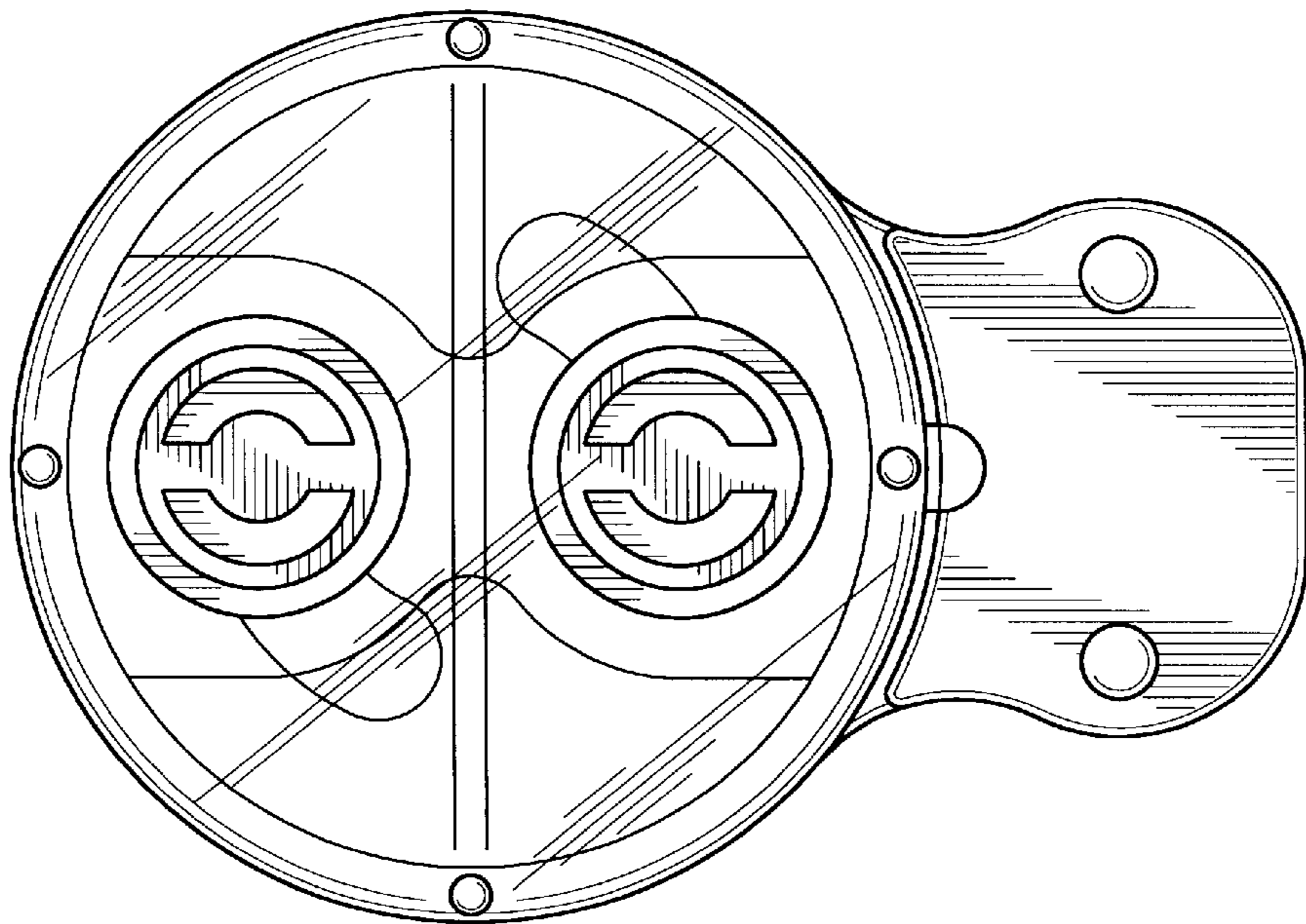

FIG. 4

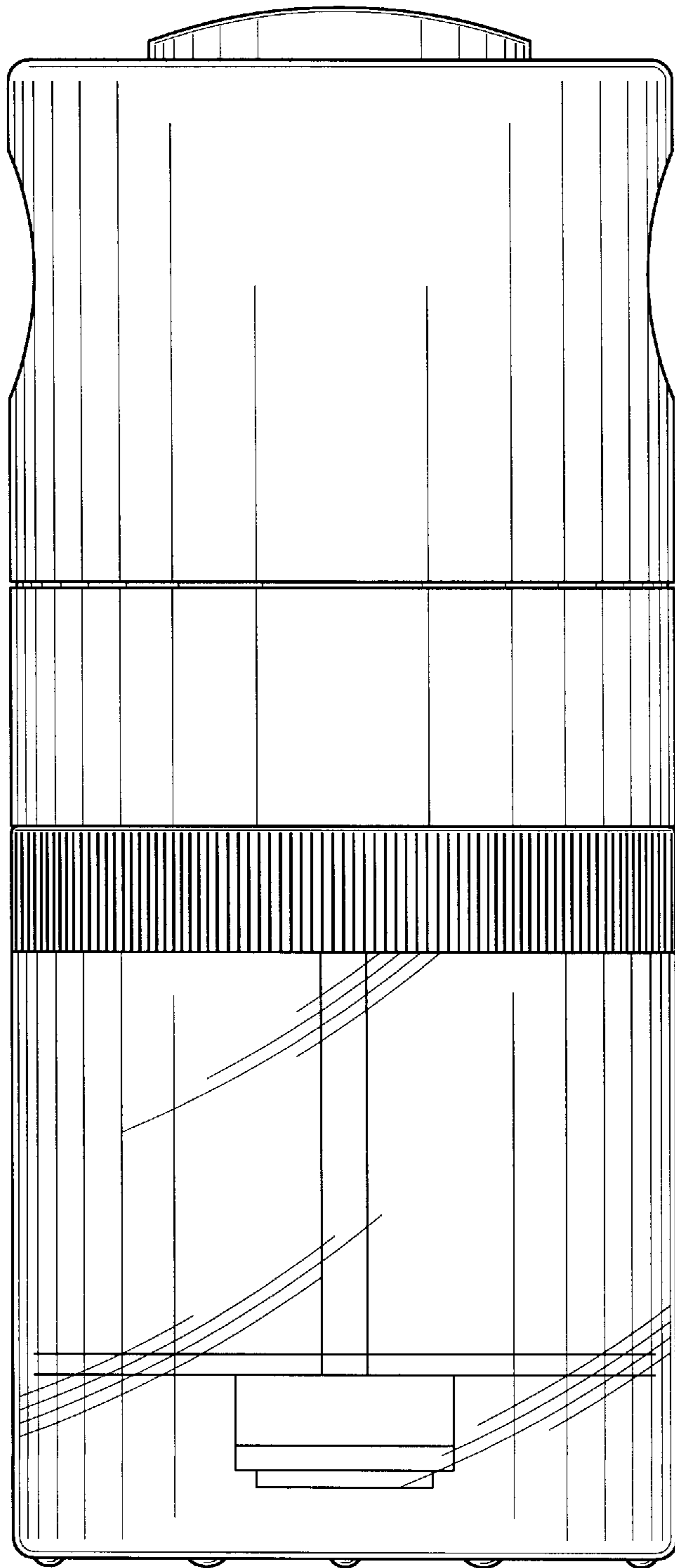

FIG. 5

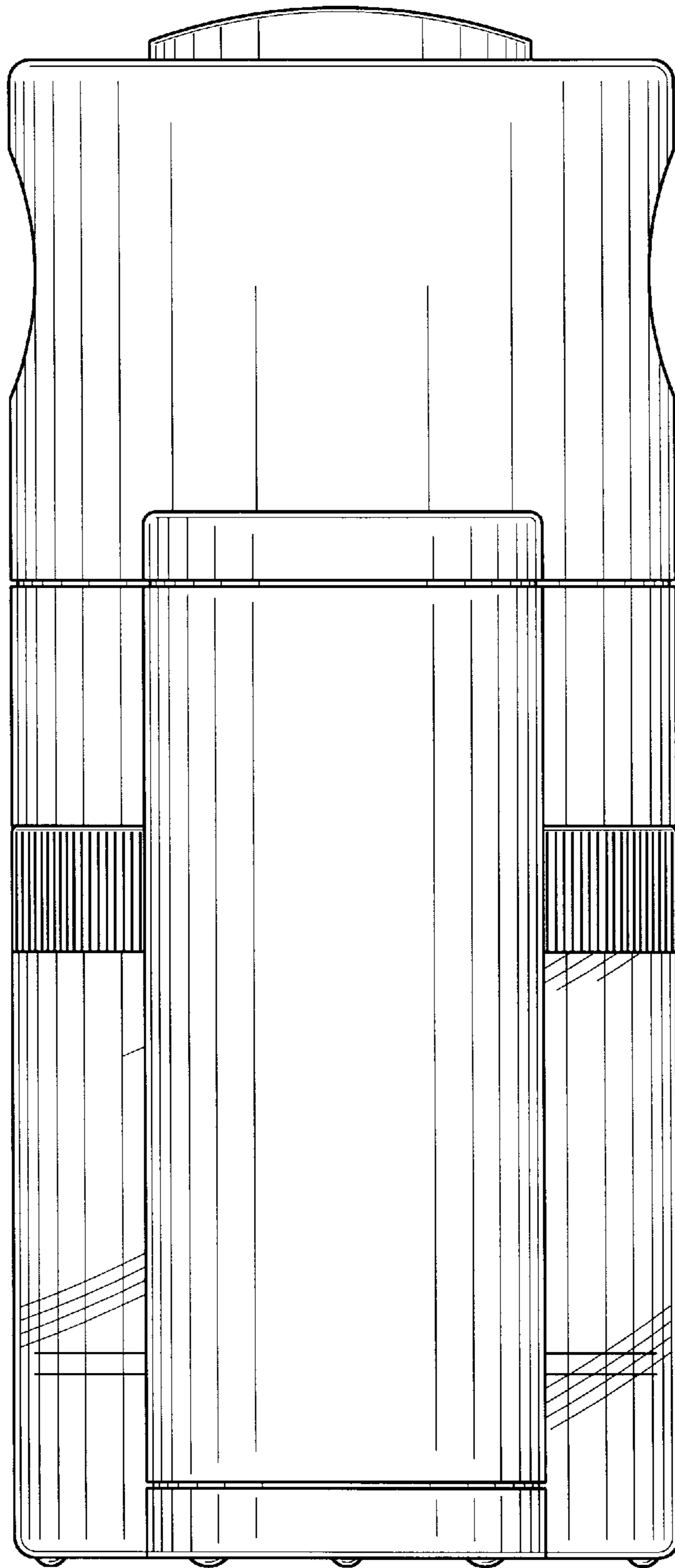

FIG. 6