



US00D404229S

United States Patent [19]
Dammermann et al.

[11] **Patent Number: Des. 404,229**

[45] **Date of Patent: **Jan. 19, 1999**

[54] **SEATING UNIT**

[75] Inventors: **Arnold B. Dammermann**, Grand Rapids, Mich.; **Michael L. Deimen**, Burluson, Tex.

[73] Assignee: **Steelcase Inc.**, Grand Rapids, Mich.

[**] Term: **14 Years**

[21] Appl. No.: **60,535**

[22] Filed: **Sep. 30, 1996**

Related U.S. Application Data

[62] Division of Ser. No. 35,345, Feb. 17, 1995, Pat. No. Des. 383,323.

[51] **LOC (6) Cl.** **06-06**

[52] **U.S. Cl.** **D6/500; D6/366; D6/502**

[58] **Field of Search** **D6/334, 364, 365, D6/366, 367, 379, 380, 500, 501, 502; 297/411.2, DIG. 1**

[56] **References Cited**

U.S. PATENT DOCUMENTS

- D. 185,849 8/1959 Christenson et al. .
- D. 236,173 8/1975 Ruf .
- D. 296,624 7/1988 Bellini .
- D. 299,799 2/1989 Muller-Deisig et al. .
- D. 306,531 3/1990 Snodgrass .
- D. 309,383 7/1990 Muller-Deisig et al. .
- D. 311,286 10/1990 Muller-Deisig et al. .
- D. 312,003 11/1990 Muller-Deisig et al. .
- D. 312,536 12/1990 Muller-Deisig et al. .
- D. 315,066 3/1991 Adams et al. .
- D. 315,836 4/1991 Kaiser .
- D. 318,184 7/1991 Muller-Deisig et al. .
- D. 320,507 10/1991 Shields .
- D. 322,363 12/1991 Narita .

(List continued on next page.)

OTHER PUBLICATIONS

Exhibit A is a product brochure entitled "Relax Armrest," publication date unknown, published by RH Form AB, Bodafors, Sweden, disclosing an armrest.

Exhibit B is a product brochure entitled "The Chair Works," publication date unknown, published by The Chair Works, Inc., College Station, Texas, disclosing chairs having armrests.

Exhibit C is a product brochure entitled "Comforto®," publication date unknown, published by Haworth, Europe, disclosing various chairs with arms.

Exhibit D is a product brochure entitled "Office Views," publication date unknown, published by Sitag International, Irvine, California, disclosing various chairs with arms.

Exhibit E is coassigned, copending application Ser. No. 29/035,048, filed Feb. 17, 1995, entitled "Seating Unit," which illustrates a seating unit shown in Jun., 1995 at a trade show.

Exhibit F is coassigned, copending application Ser. No. 29/035,345, filed Feb. 17, 1995, entitled "Seating Unit," which illustrates a seating unit shown in Jun., 1995 at a trade show.

Primary Examiner—Gary D. Watson
Attorney, Agent, or Firm—Price, Heneveld, Cooper, DeWitt & Litton

[57] **CLAIM**

The ornamental design for a seating unit, as shown and described.

DESCRIPTION

FIG. 1 is a front perspective view of a seating unit of the present invention;

FIG. 2 is a left side elevational view thereof, the right side being a mirror image;

FIG. 3 is a front elevational view thereof;

FIG. 4 is a top plan view thereof;

FIG. 5 is a rear elevational view thereof; and,

FIG. 6 is a perspective view of the embodiment shown in FIG. 1 .

The broken line showing of a pedestal base in FIG. 6 is for environmental purposes only and forms no part of the claimed design.

1 Claim, 3 Drawing Sheets

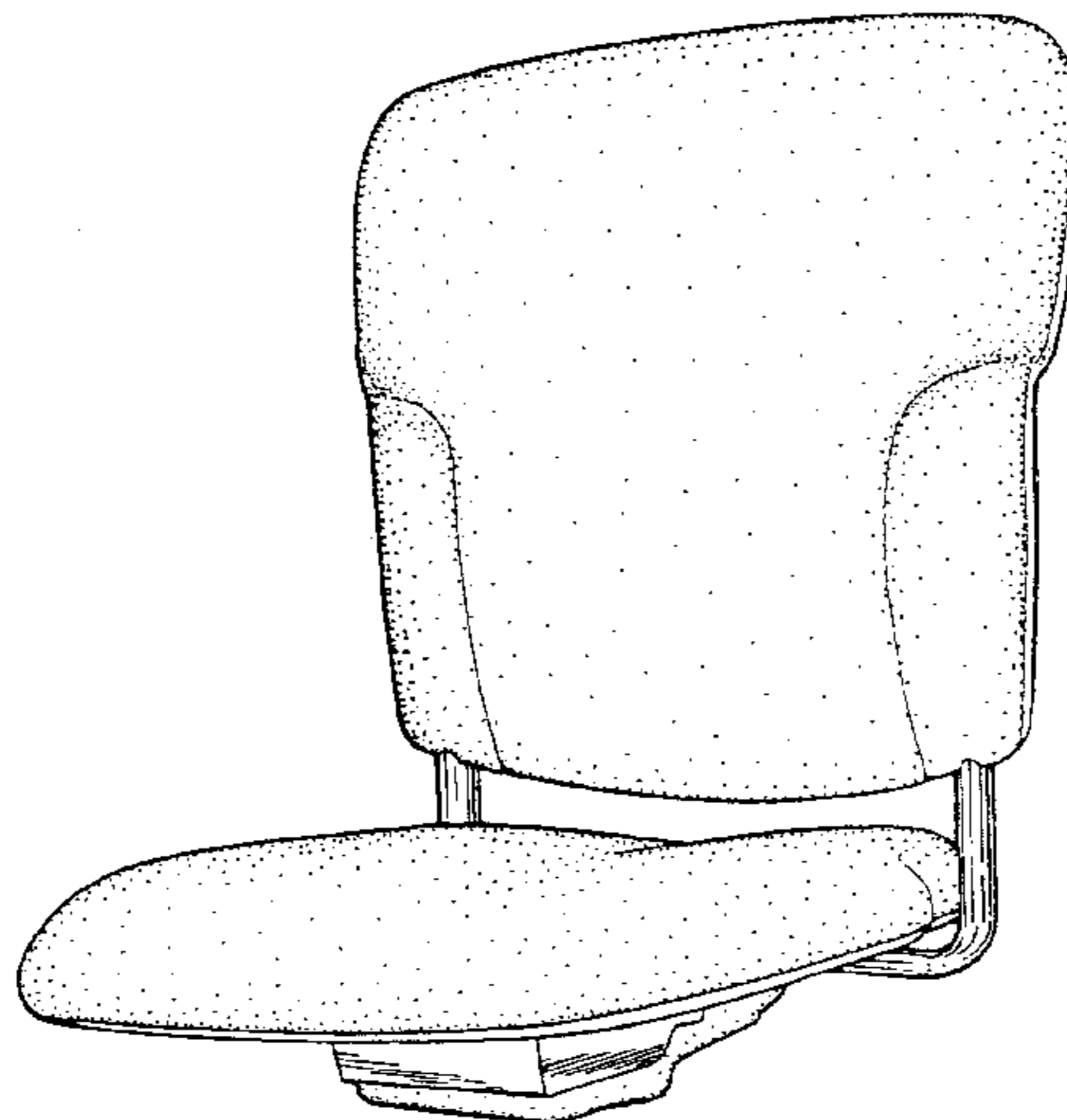

U.S. PATENT DOCUMENTS

D. 326,369	5/1992	Buchacz .	3,704,911	12/1972	Milakovich .
D. 327,585	7/1992	Hollington .	4,720,142	1/1988	Holdredge et al. .
D. 345,470	3/1994	Narita .	4,744,603	5/1988	Knoblock .
D. 346,909	5/1994	Obata et al. .	4,911,501	3/1990	Decker et al. .
D. 354,178	1/1995	Ochsner .	4,966,412	10/1990	Dauphin .
D. 358,064	5/1995	Larkin .	5,029,940	7/1991	Golynsky et al. .
D. 368,172	3/1996	Locher .	5,035,466	7/1991	Mathews et al. .
D. 372,595	8/1996	Schultz et al. .	5,046,780	9/1991	Decker et al. .
D. 383,323	9/1997	Dammermann et al. D6/366	5,106,157	4/1992	Nagelkirk et al. .
D. 388,258	12/1997	Ambasz D6/366	5,288,138	2/1994	Stulik et al. .
D. 390,384	2/1998	Schultz et al. D6/500	5,318,345	6/1994	Olson .
			5,385,388	1/1995	Faiks et al. .

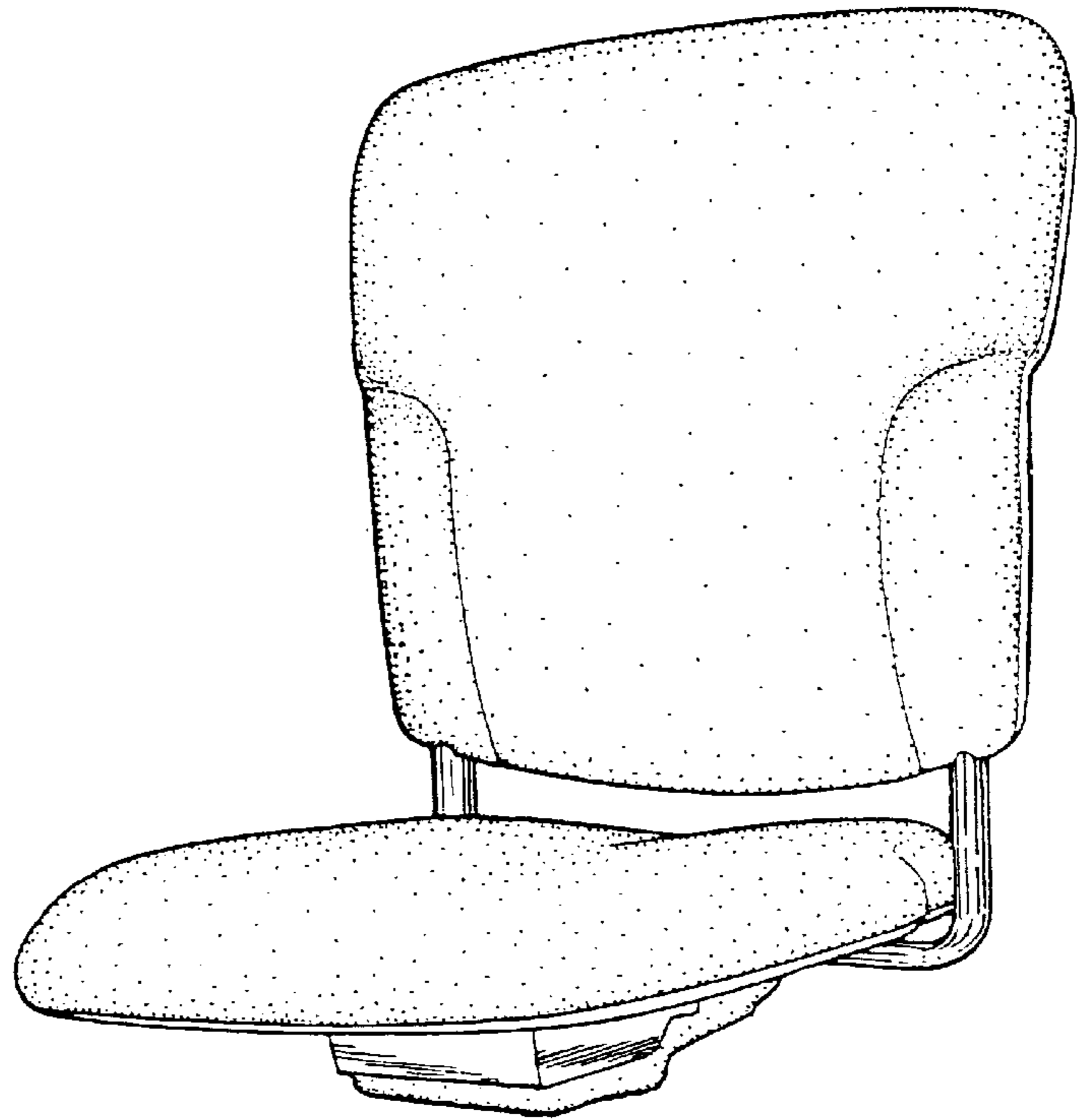

Fig. 1

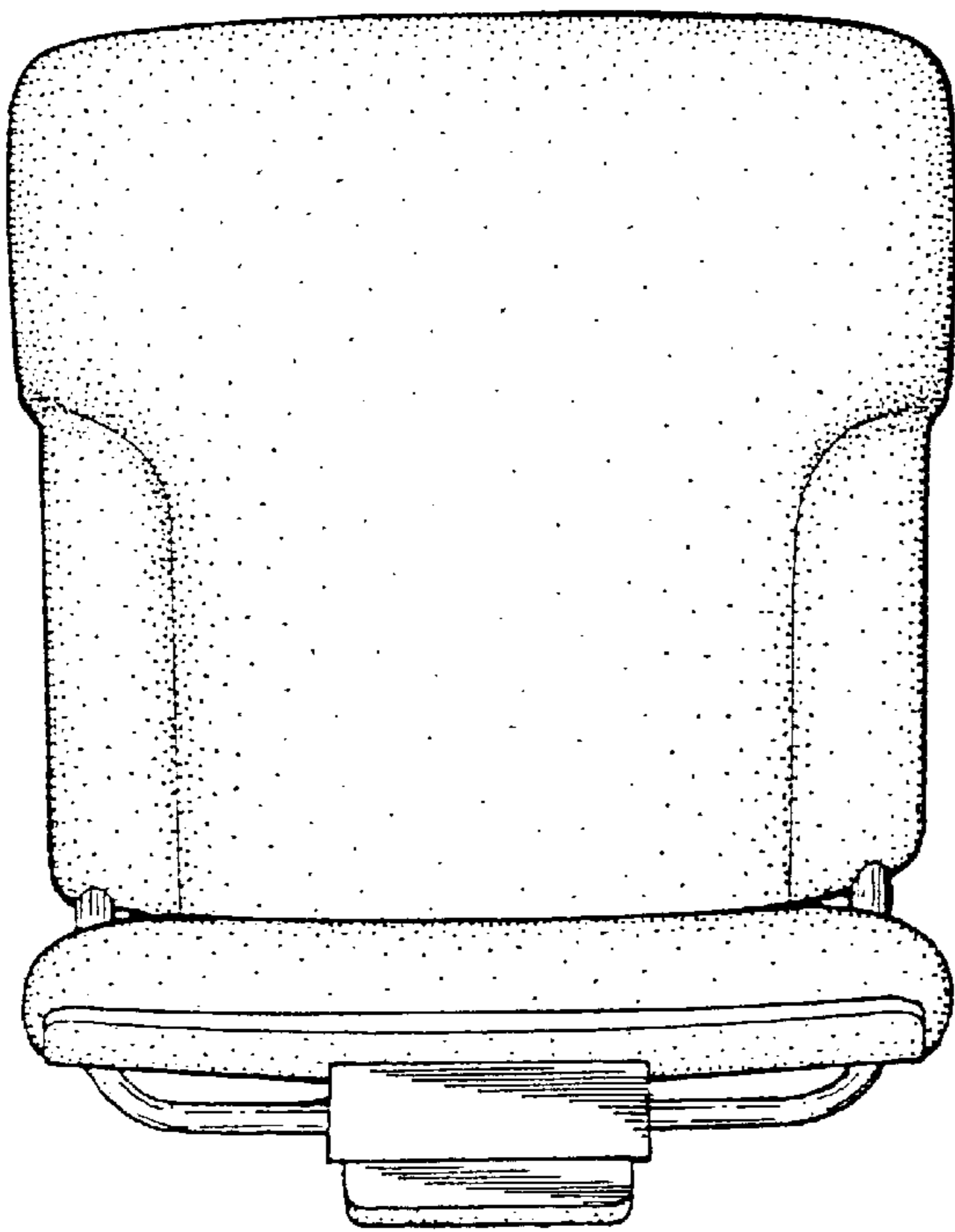

Fig. 3

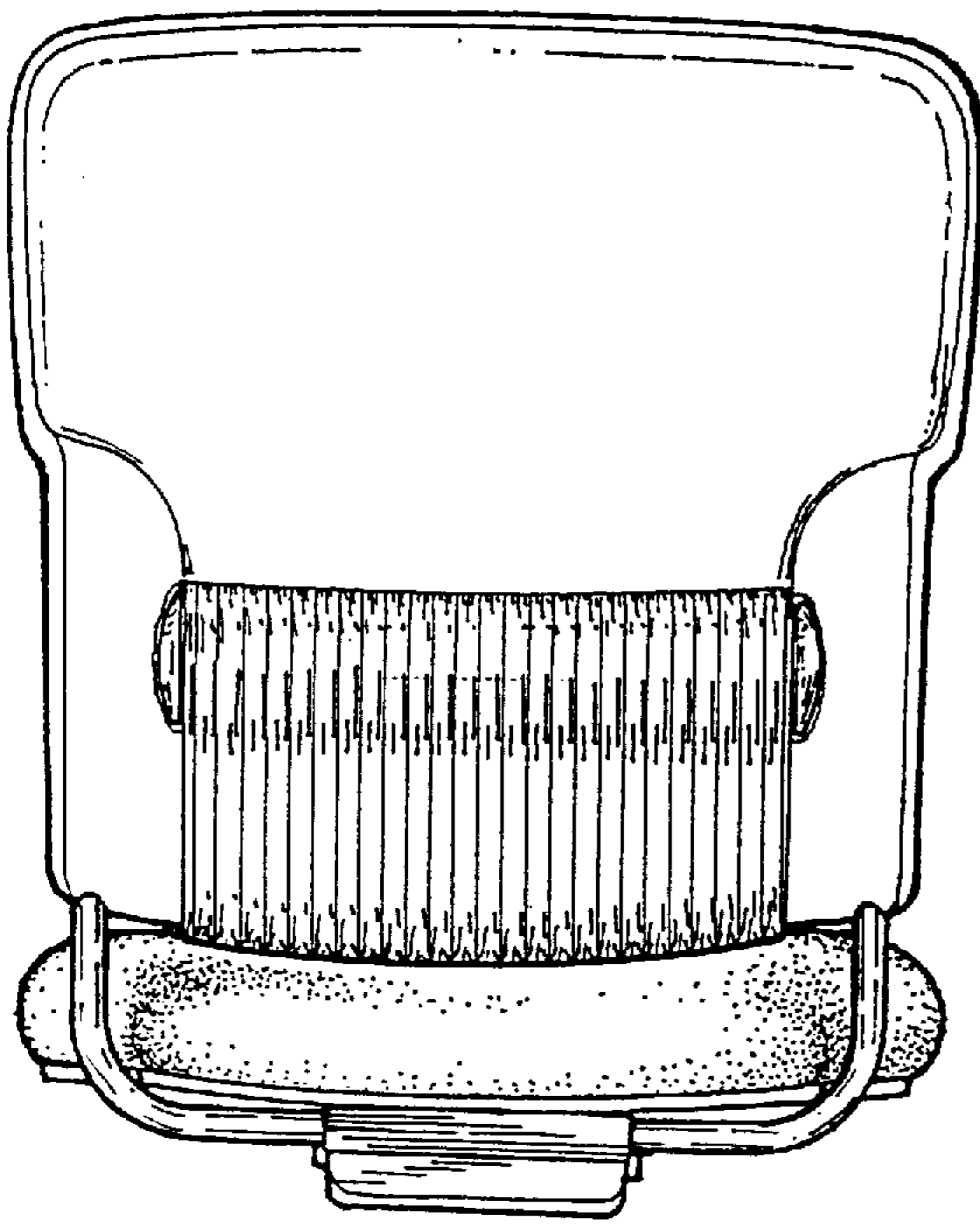

Fig. 5

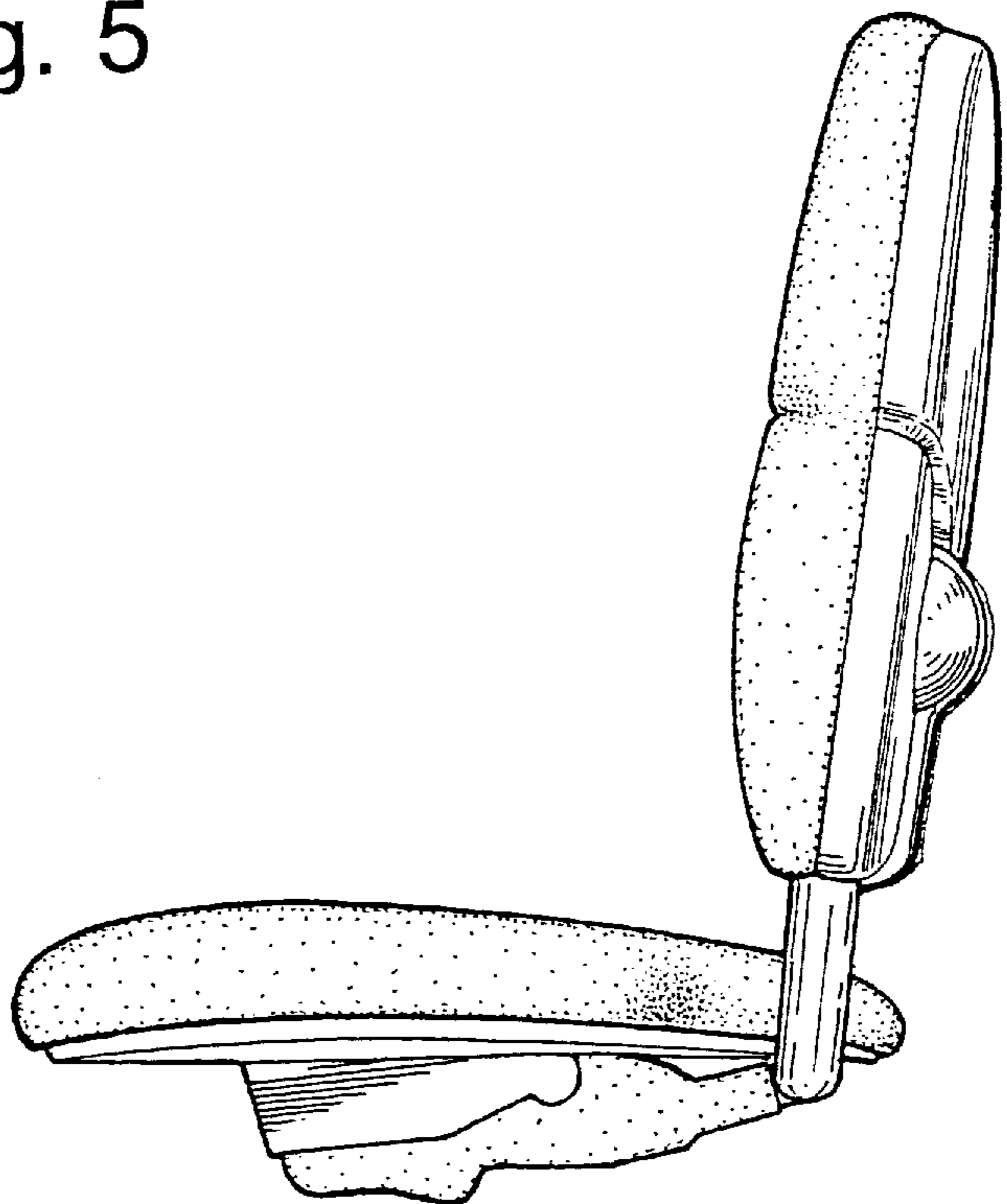

Fig. 2

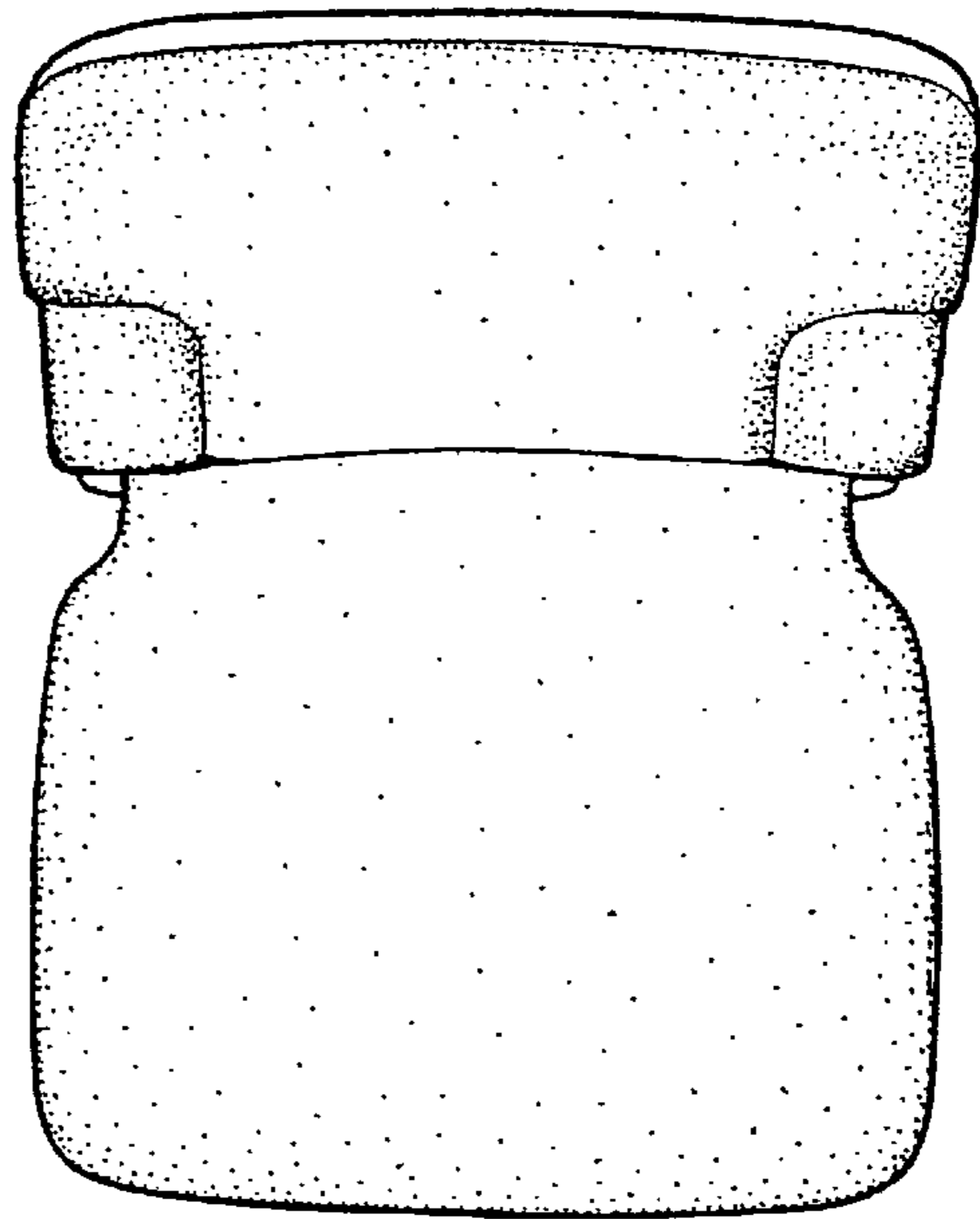

Fig. 4

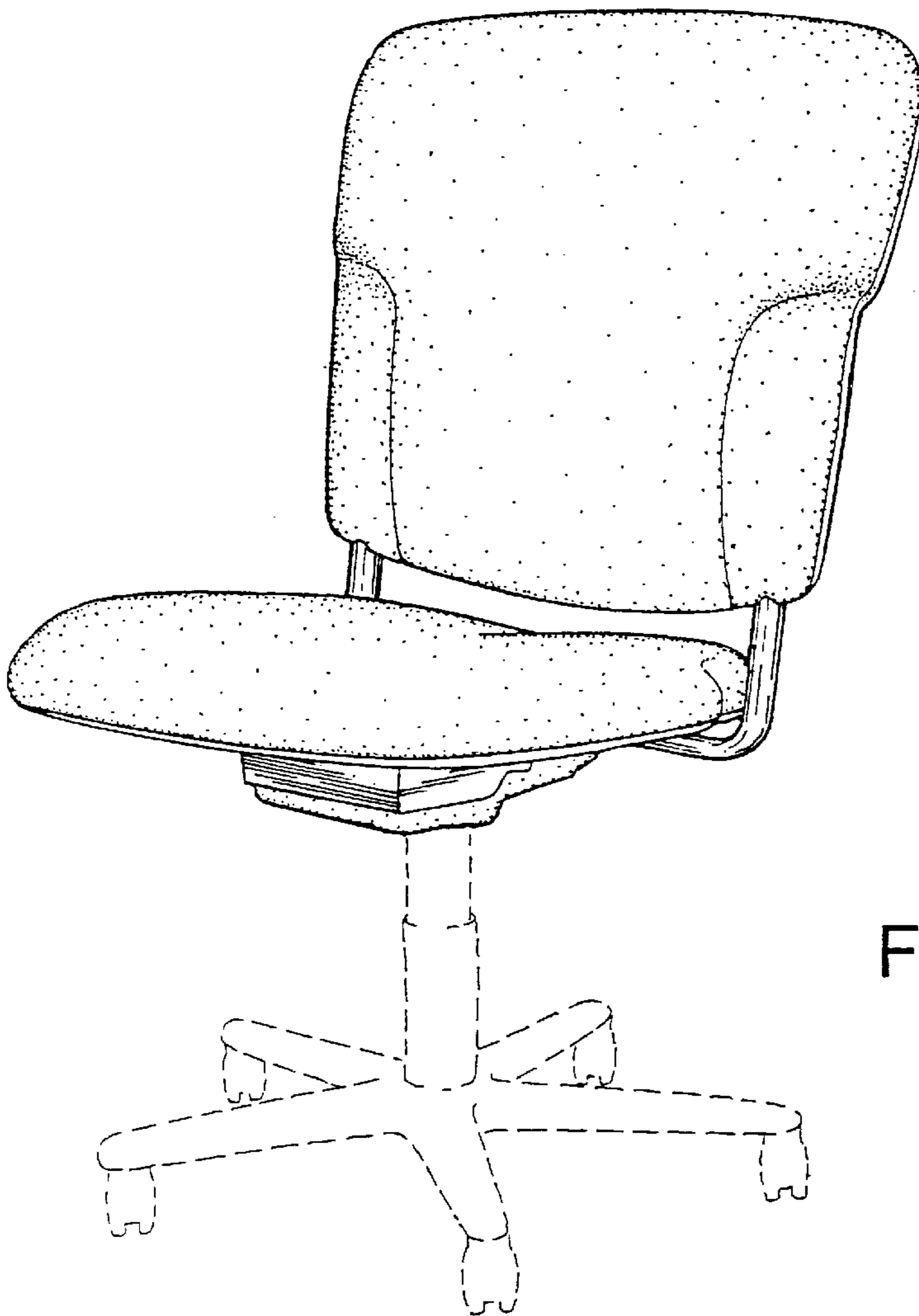

Fig. 6