



US00D404199S

# United States Patent [19]

Letson

[11] **Patent Number: Des. 404,199**

[45] **Date of Patent: \*\*Jan. 19, 1999**

[54] **COIL NAIL HOLDER**

[76] Inventor: **Robert H. Letson**, 2321 E. Pine Tree Ct., Milton, Wis. 53563

[\*\*] Term: **14 Years**

[21] Appl. No.: **75,037**

[22] Filed: **Jul. 22, 1997**

[51] **LOC (6) Cl.** ..... **03-01**

[52] **U.S. Cl.** ..... **D3/228**

[58] **Field of Search** ..... D3/215, 220, 219, D3/224, 226, 228, 229, 303; 224/904, 901, 240, 241, 245, 197, 666; D22/147; 48/373; D8/373, 80

[56] **References Cited**

**U.S. PATENT DOCUMENTS**

- D. 280,466 9/1985 Seltzer et al. .... D3/303 X
- D. 332,351 1/1993 Smith ..... D3/228
- D. 344,630 3/1994 Doerksen ..... D3/230

- D. 350,849 9/1994 Dancyger ..... D3/228
- 3,294,298 12/1966 Danielson ..... 224/666
- 4,821,933 4/1989 Seber ..... 224/904
- 5,547,115 8/1996 Ambrosius et al. .... 224/904 X

*Primary Examiner*—Doris V. Coles  
*Assistant Examiner*—Catherine R. Oliver

[57] **CLAIM**

The ornamental design for a coil nail holder, as shown.

**DESCRIPTION**

FIG. 1 is a front elevational view of a coil nail holder showing my new design;  
 FIG. 2 is a right side elevational view, with the left side elevational view being a mirror image thereof;  
 FIG. 3 is a top plan view thereof;  
 FIG. 4 is a rear elevational view thereof;  
 FIG. 5 is a bottom view thereof; and,  
 FIG. 6 is a perspective view thereof.

**1 Claim, 2 Drawing Sheets**

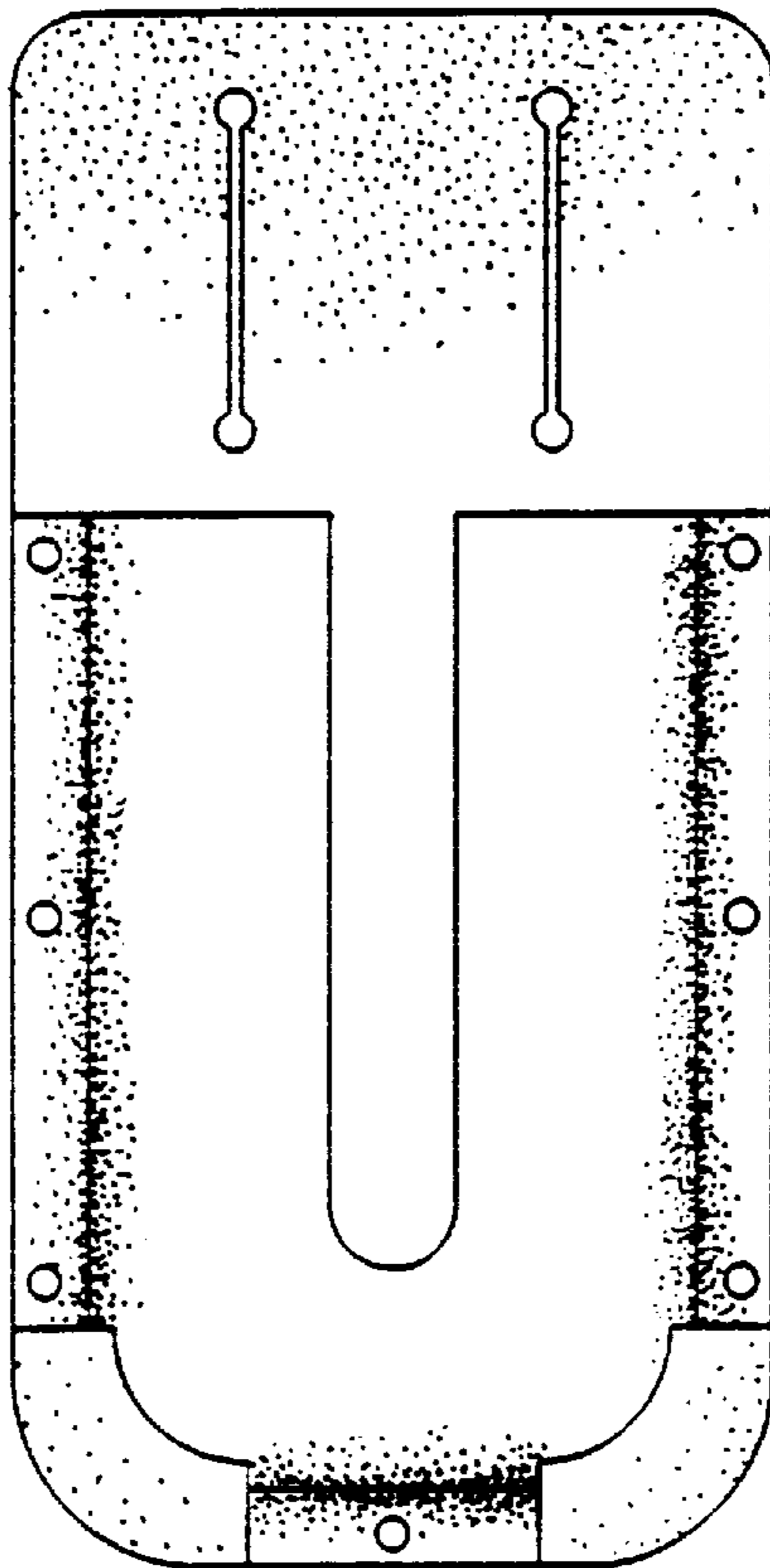

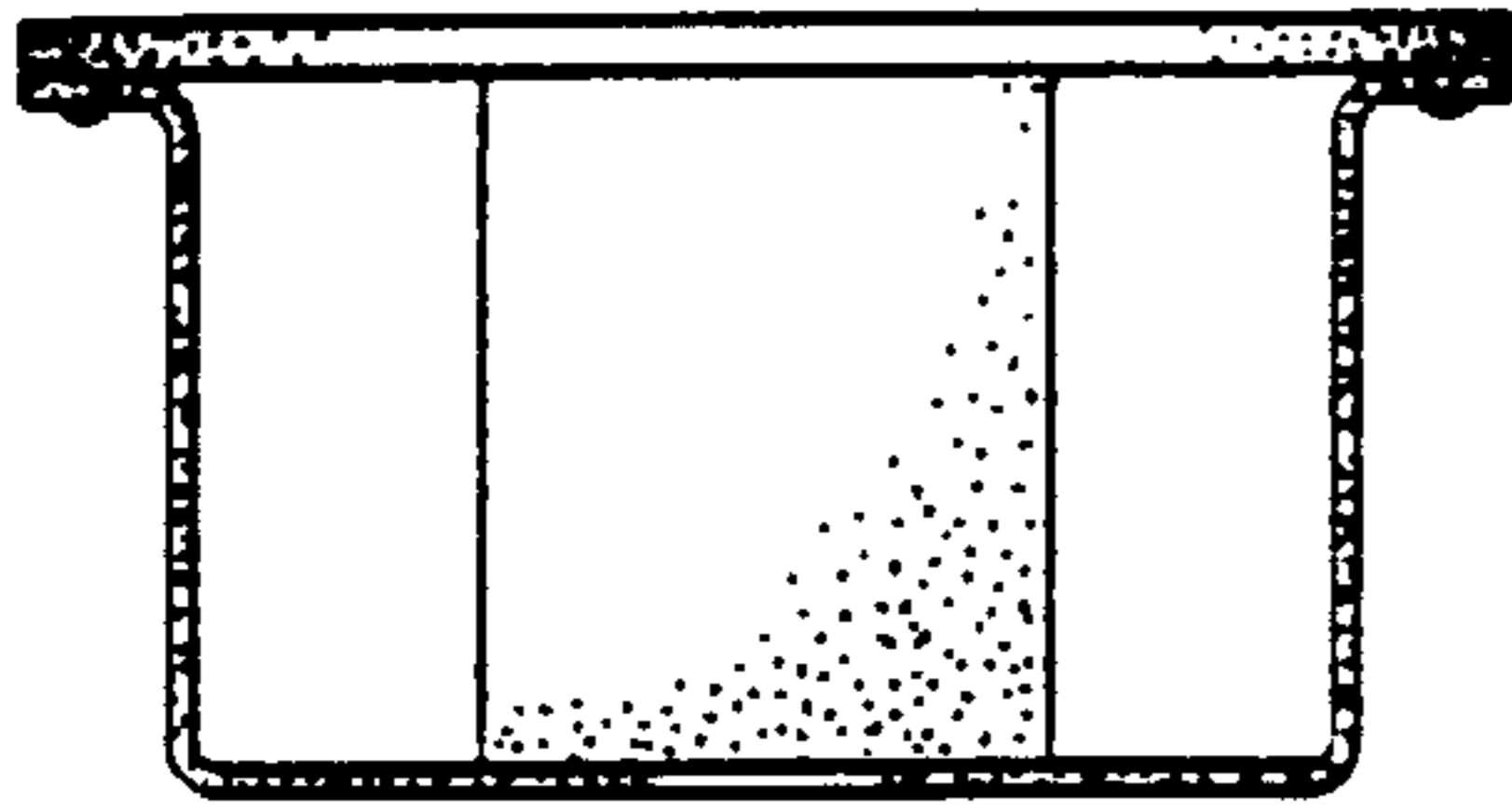

FIGURE 3

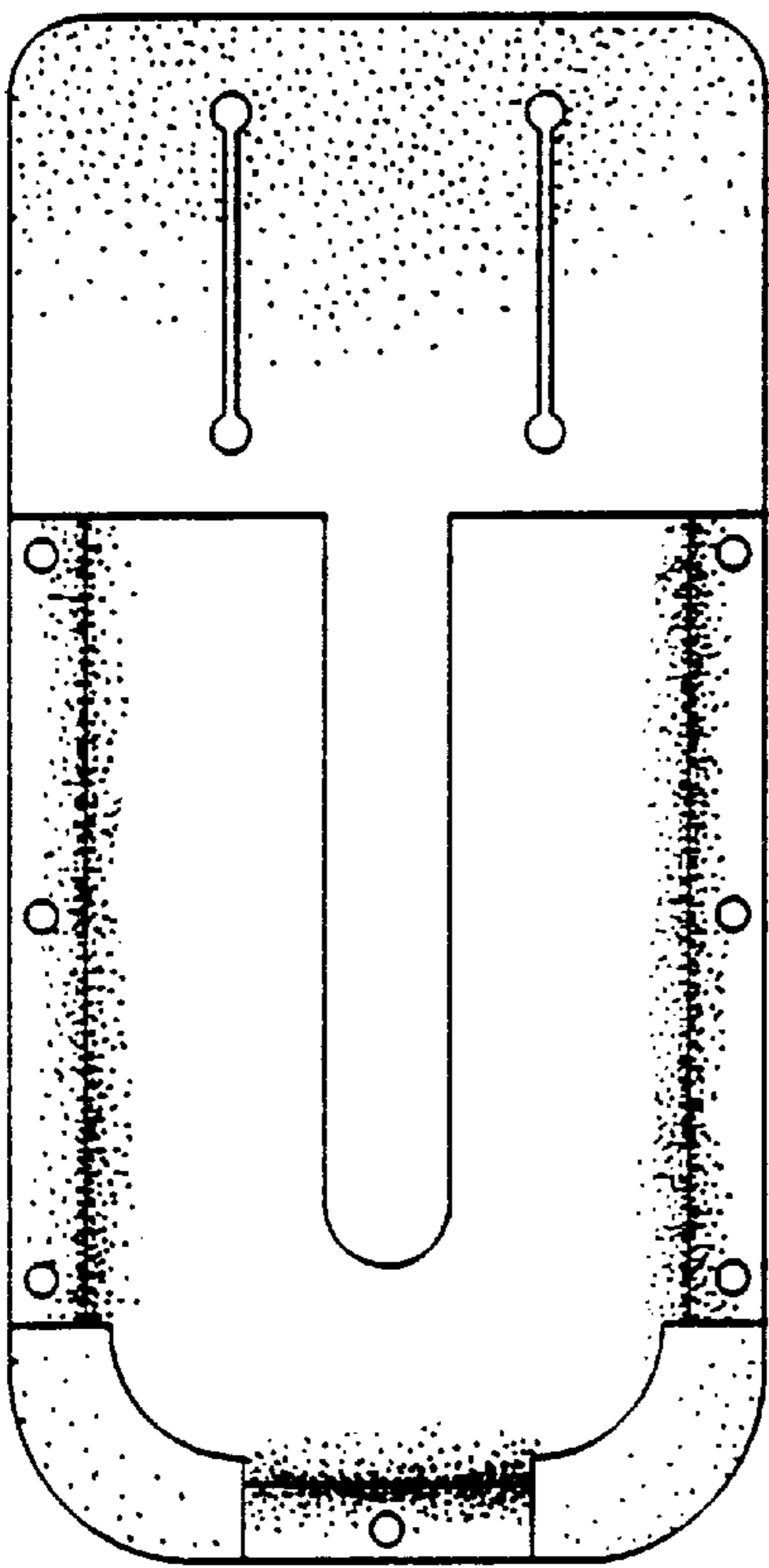

FIGURE 1

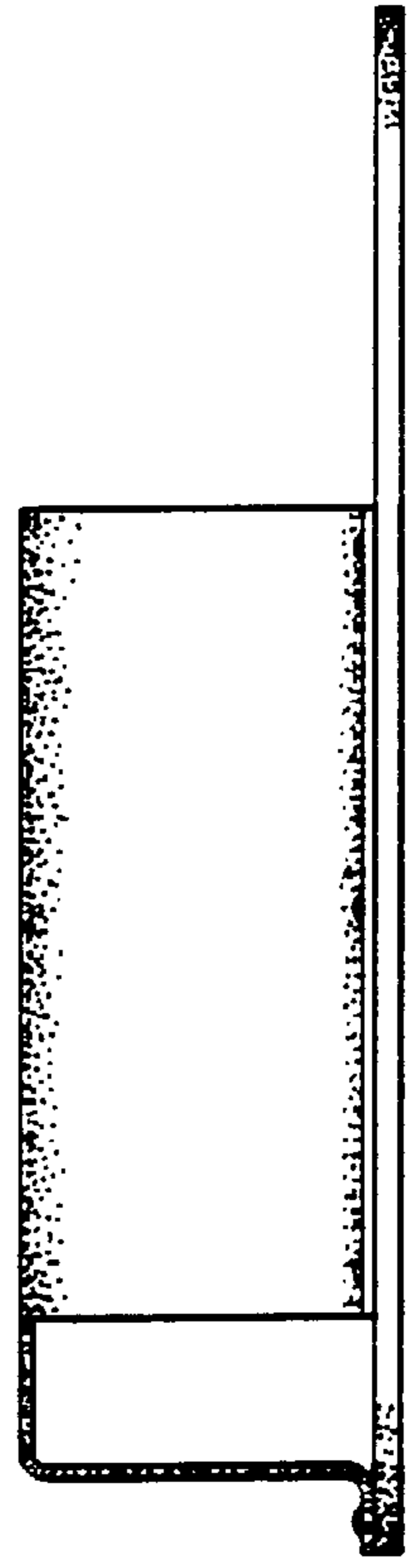

FIGURE 2

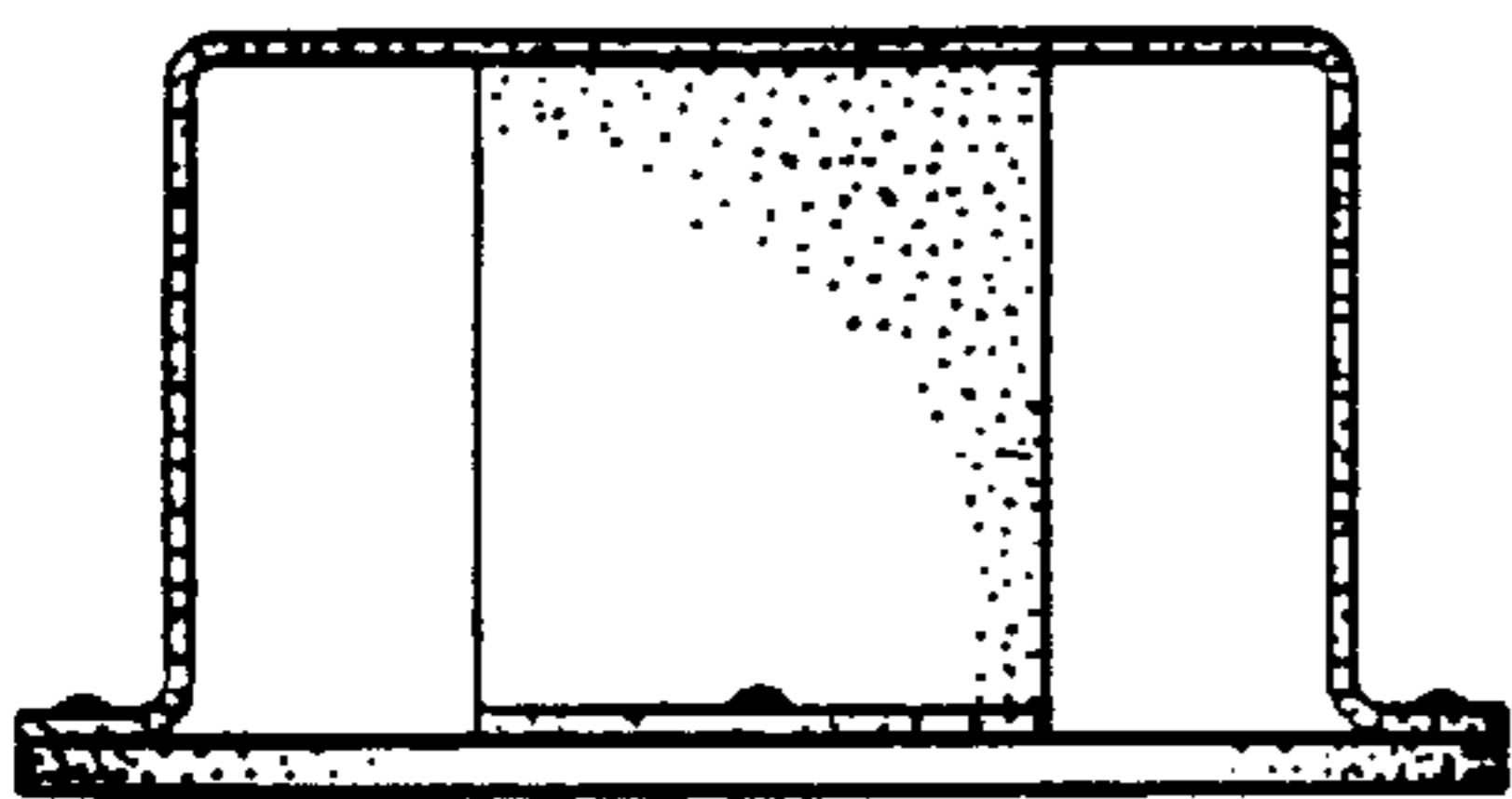

FIGURE 5

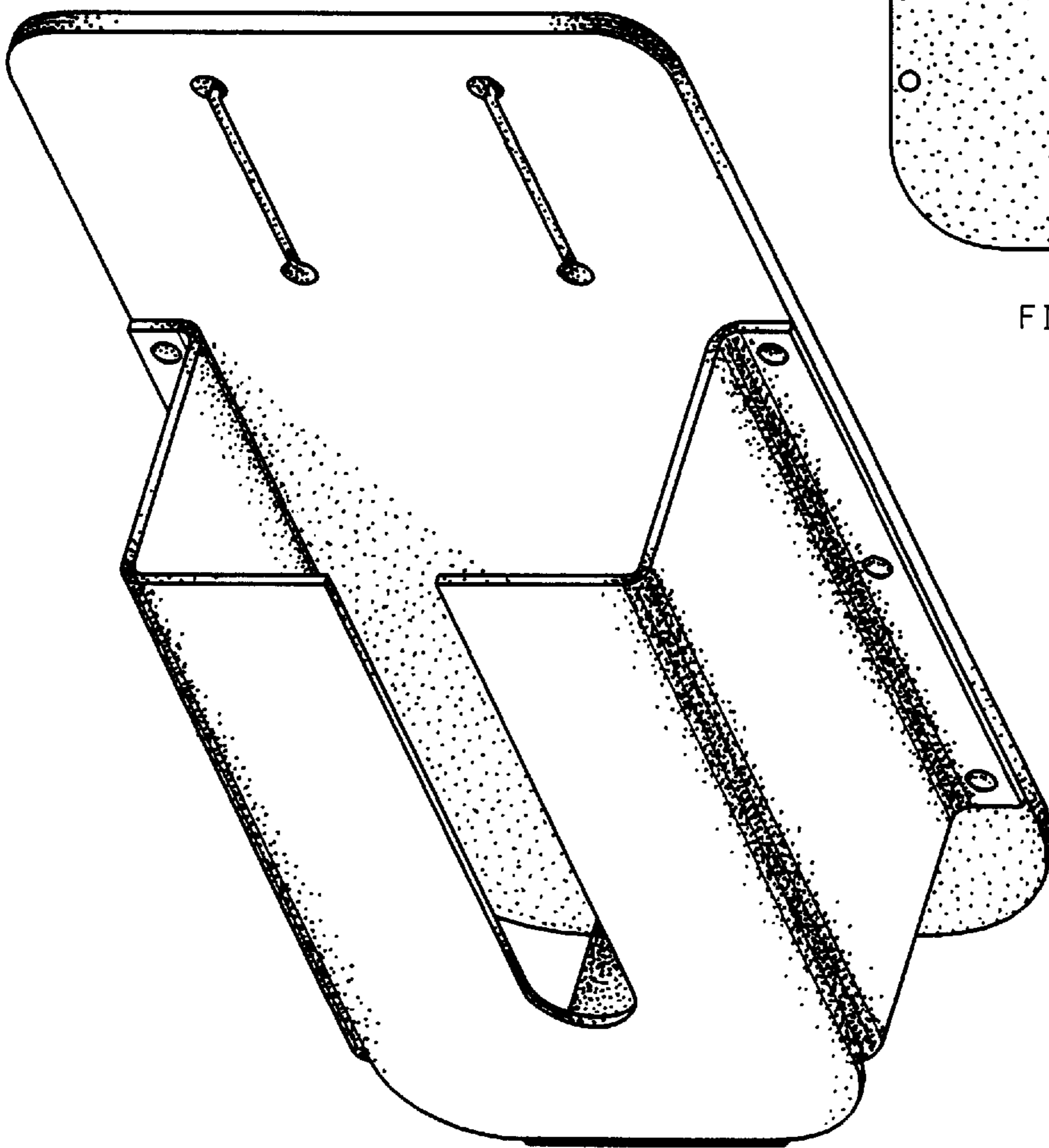

FIGURE 6

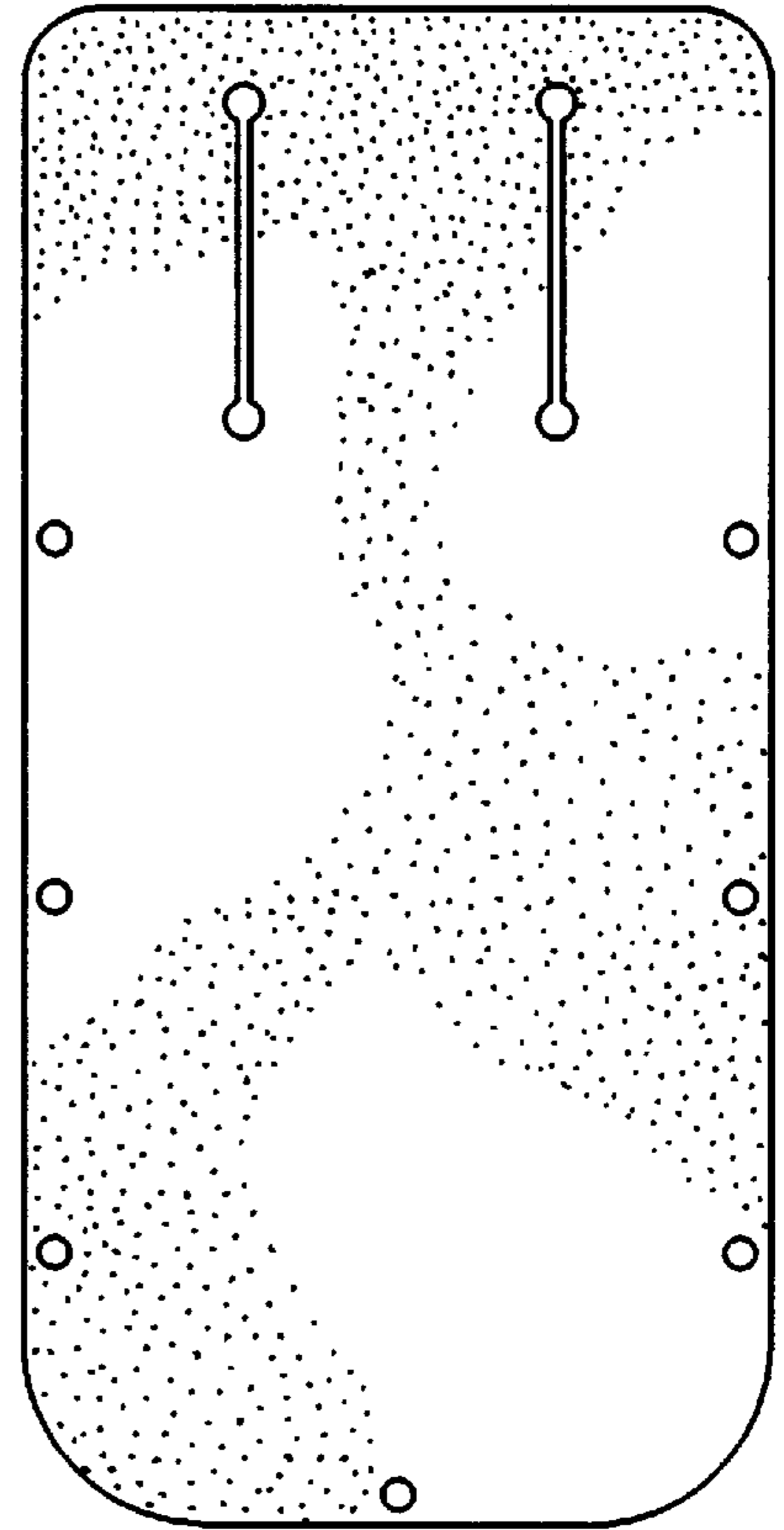

FIGURE 4