



US00D404091S

# United States Patent [19]

Nizza

[11] **Patent Number: Des. 404,091**

[45] **Date of Patent: \*\*Jan. 12, 1999**

[54] **BUILDING BLOCK**

[76] Inventor: **Robert Nizza**, 20 Grant Ave., Islip, N.Y. 11751

[\*\*] Term: **14 Years**

[21] Appl. No.: **60,451**

[22] Filed: **Sep. 30, 1996**

[51] **LOC (6) Cl. .... 21-01**

[52] **U.S. Cl. .... D21/505**

[58] **Field of Search** ..... D21/108, 109, D21/59, 104-107; 446/85, 93-96, 103, 105, 108, 111, 120, 122, 124-125, 128; 273/153 R, 157 R, 156, 160

[56] **References Cited**

**U.S. PATENT DOCUMENTS**

524,212	8/1894	Porter	.....	D21/108
735,079	8/1903	Fisher	.	
1,471,943	10/1923	Chambers	.....	273/157 R
2,216,915	10/1940	Johnson	.....	273/157
2,992,829	7/1961	Hopkins	.....	434/403
3,303,604	2/1967	Mote	.....	446/125
3,590,499	7/1971	Rinehuls	.....	D21/108
3,659,360	5/1972	Zeischegg	.....	35/72
3,662,486	5/1972	Preedman	.....	446/120
4,021,939	5/1977	May	.....	446/118
4,121,831	10/1978	Greene	.....	273/160
4,133,538	1/1979	Ambrose	.....	273/276
4,323,244	4/1982	Busing	.....	273/155
4,323,245	4/1982	Beaman	.....	273/157 R
4,334,871	6/1982	Roane	.....	434/211
4,753,622	6/1988	Nakama	.....	446/85
4,778,392	10/1988	Mitchell	.....	434/403
4,796,888	1/1989	Louez	.....	273/58 R

5,169,352	12/1992	Petersen	.....	446/85
5,221,223	6/1993	Kao	.....	446/85
5,306,198	4/1994	Forman	.....	446/120
5,417,694	5/1995	Rafelman	.....	446/124

**FOREIGN PATENT DOCUMENTS**

25272220	12/1996	Germany	.....	446/117
8135	of 1839	United Kingdom	.....	52/608

*Primary Examiner*—Raphael Barkai  
*Attorney, Agent, or Firm*—Alfred Walker

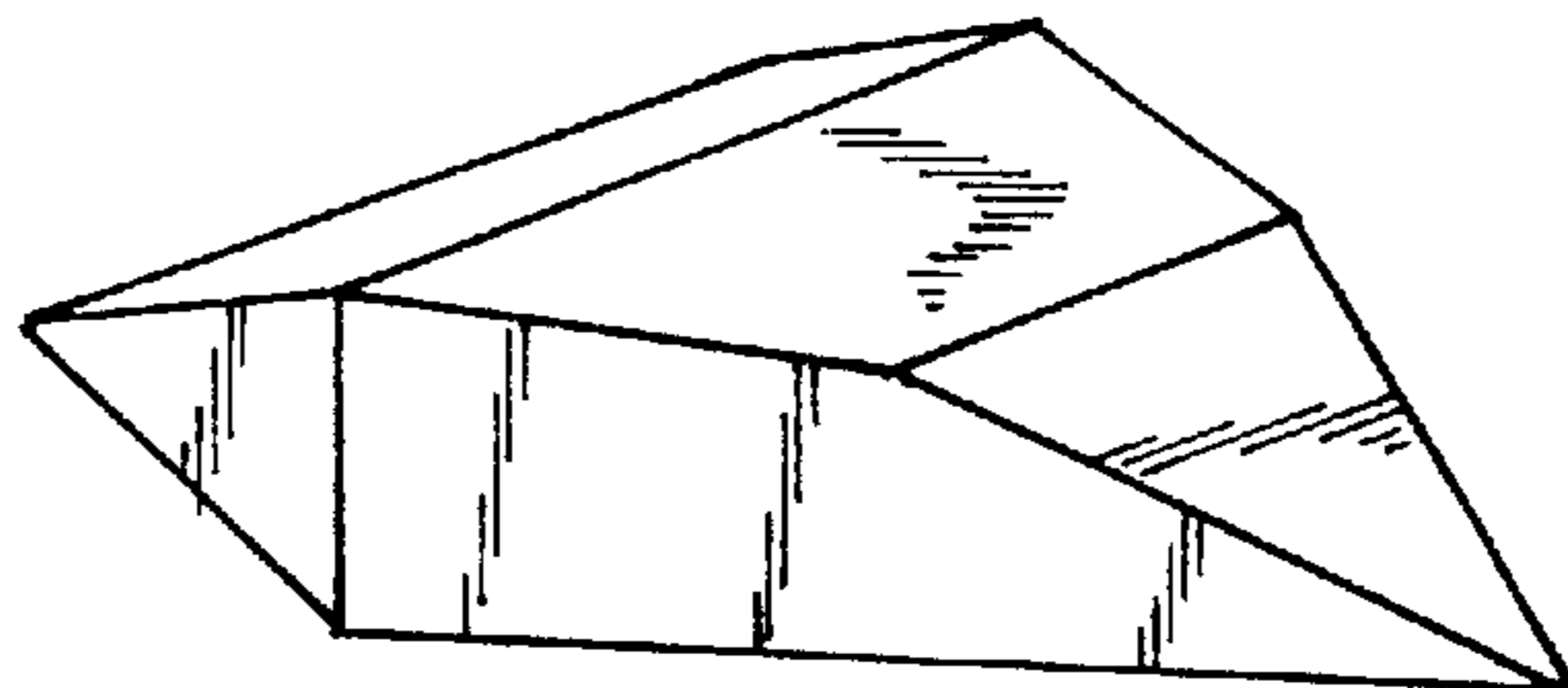
[57] **CLAIM**

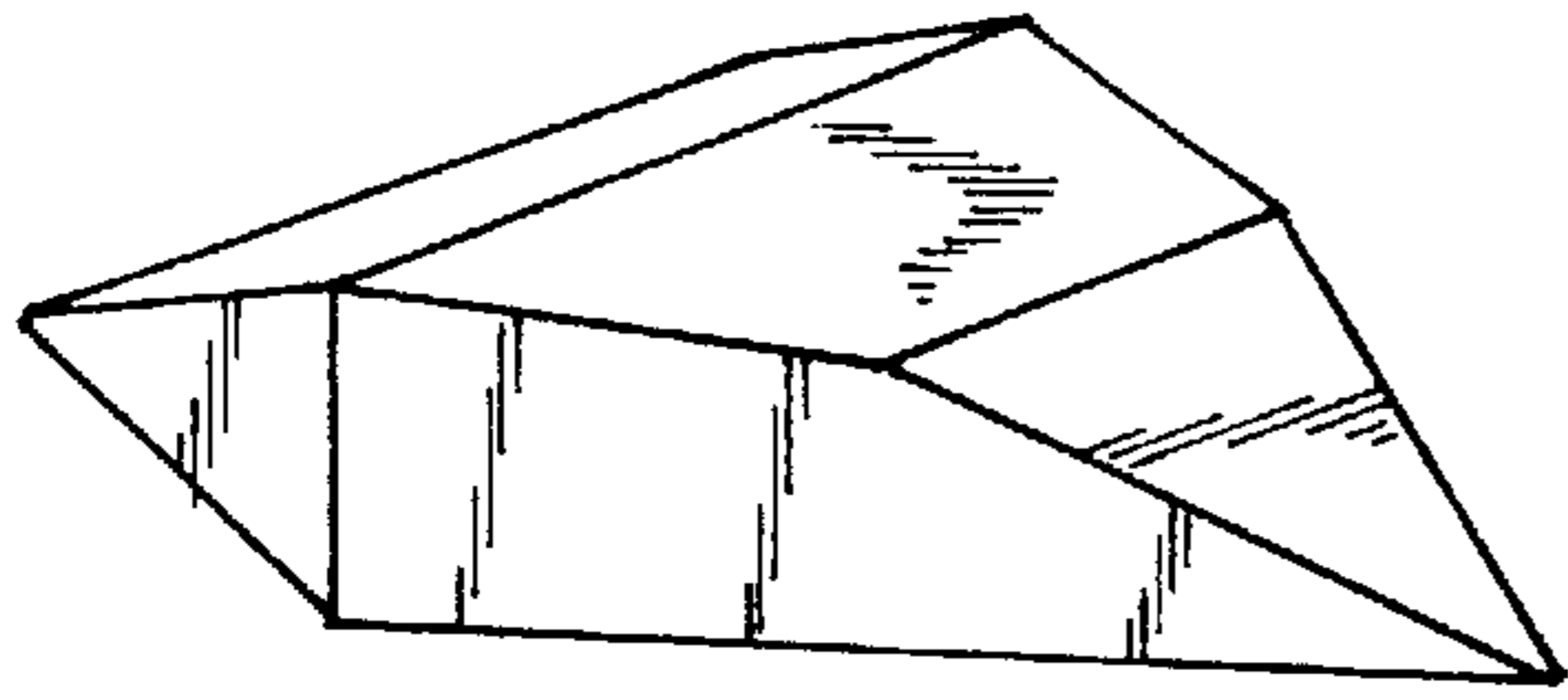
The ornamental design for a building block, as shown and described.

**DESCRIPTION**

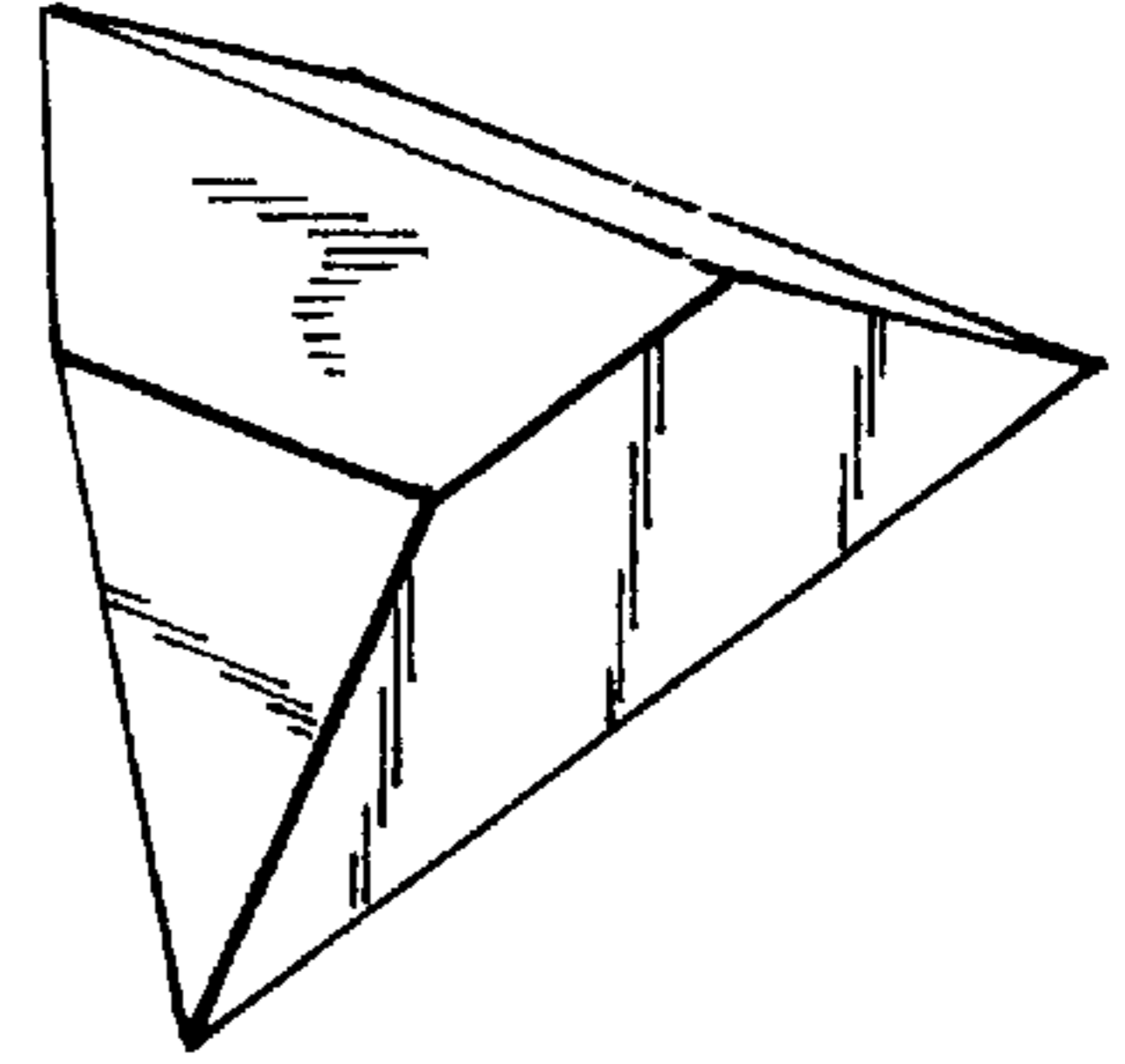
FIG. 1 is a right side perspective of the building block of the design of the present invention;  
 FIG. 2 is a left side perspective view thereof;  
 FIG. 3 is a front elevational view thereof;  
 FIG. 4 is a rear elevational view thereof;  
 FIG. 5 is a right side elevational view thereof;  
 FIG. 6 is a left side elevational view thereof;  
 FIG. 7 is a top plan view thereof;  
 FIG. 8 is a bottom view thereof;  
 FIG. 9 is a right side perspective of a modified embodiment of the building block of the design of the present invention;  
 FIG. 10 is a left side perspective view thereof;  
 FIG. 11 is a front elevational view thereof;  
 FIG. 12 is a rear elevational view thereof;  
 FIG. 13 is a right side elevational view thereof;  
 FIG. 14 is a left side elevational view thereof;  
 FIG. 15 is a top plan view thereof; and,  
 FIG. 16 is a bottom view thereof.

**1 Claim, 2 Drawing Sheets**

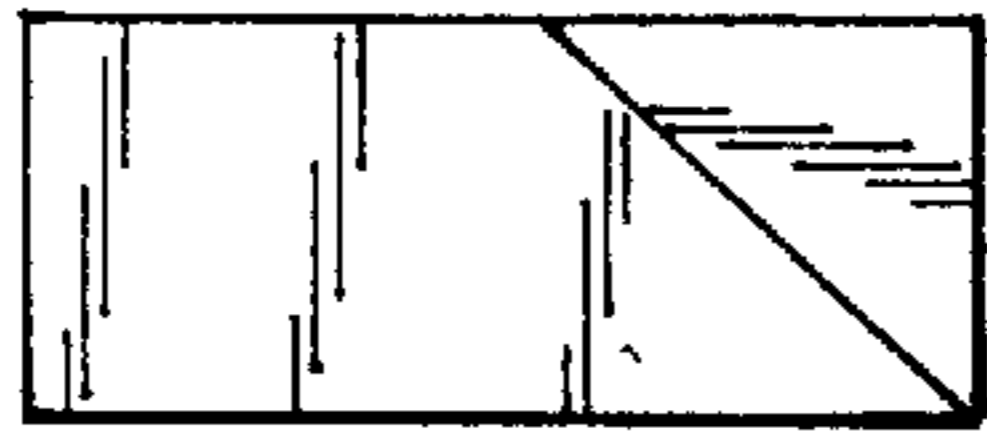




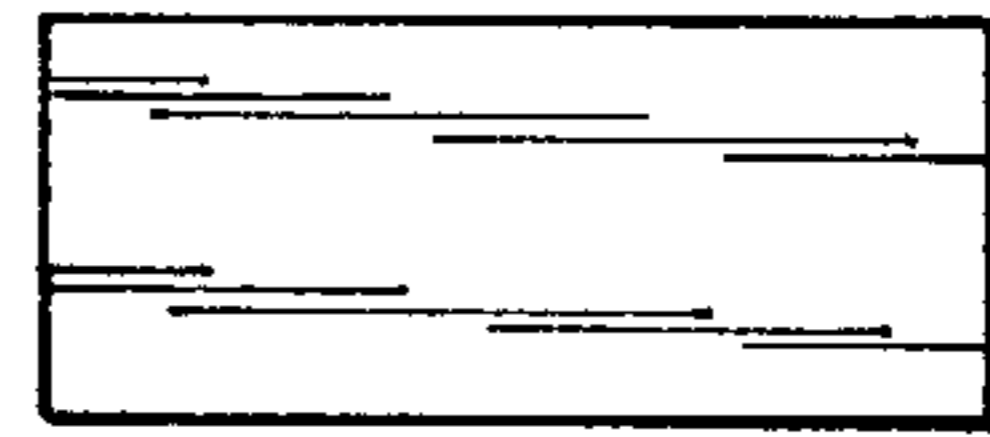
**Fig. 1**



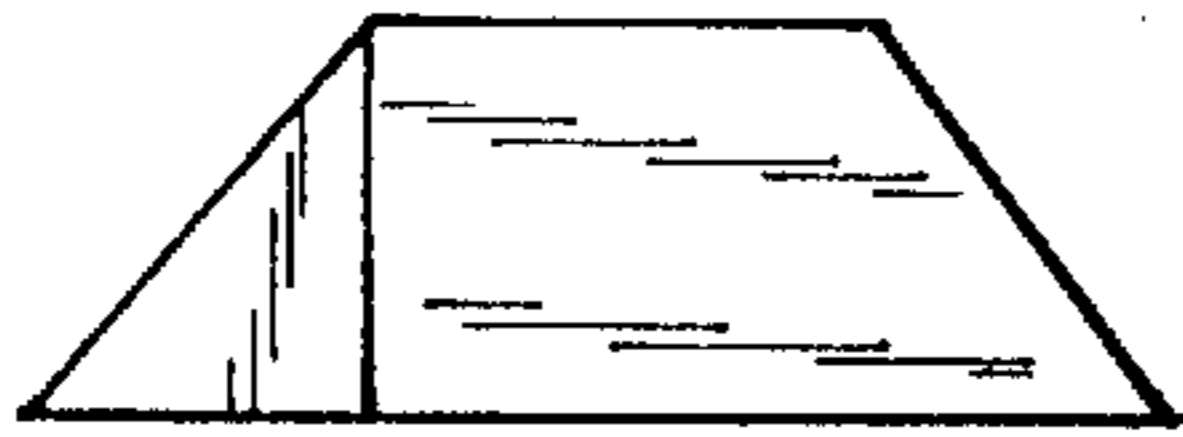
**Fig. 2**



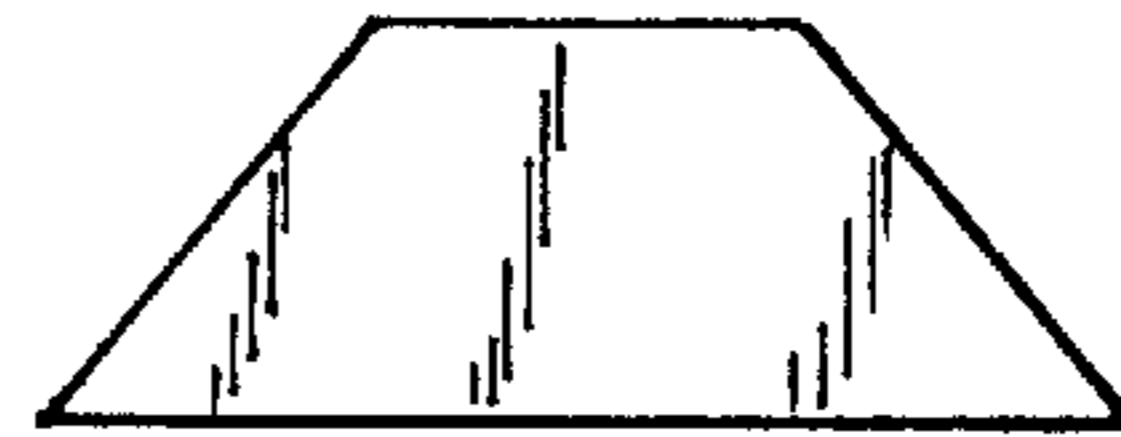
**Fig. 3**



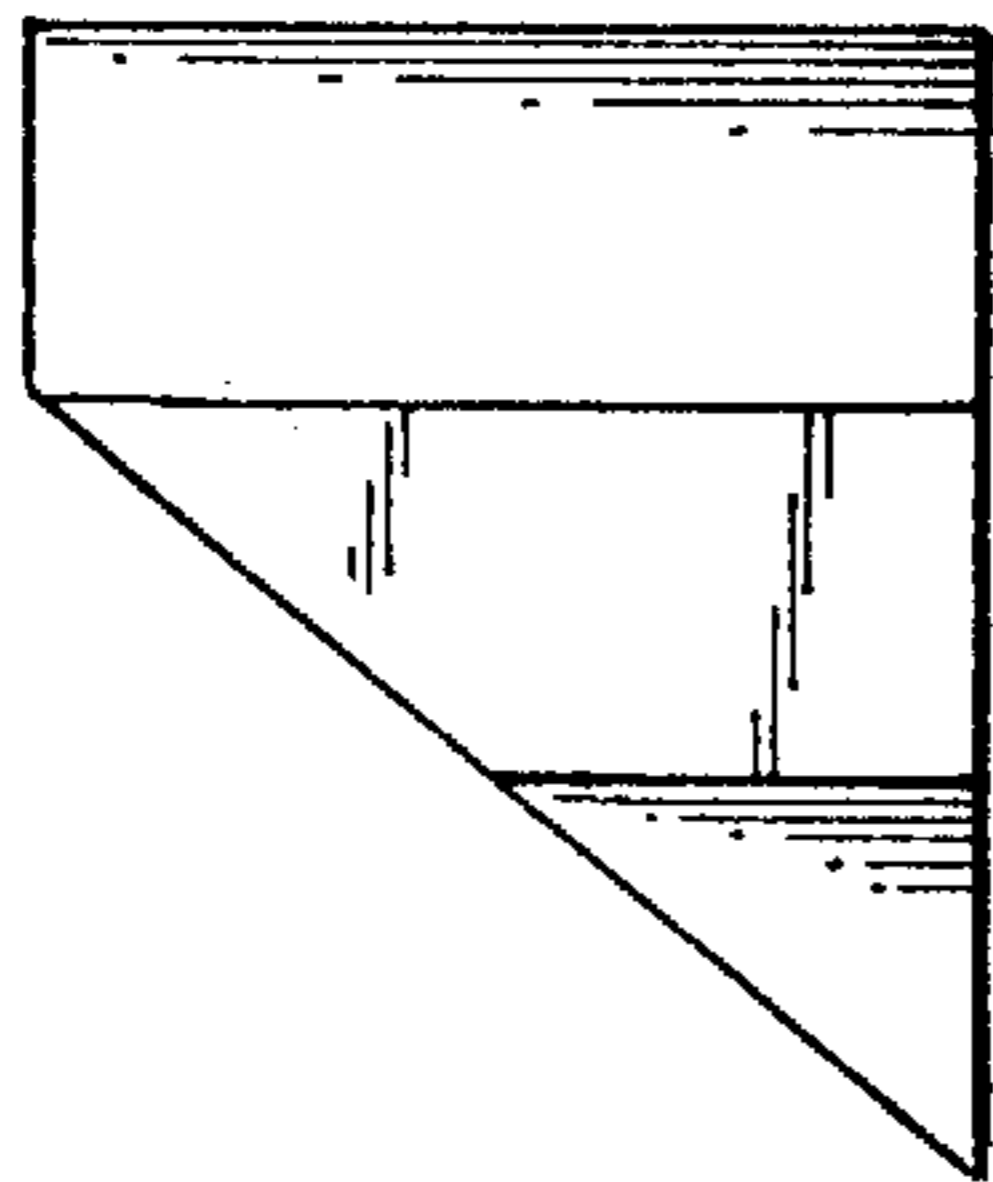
**Fig. 4**



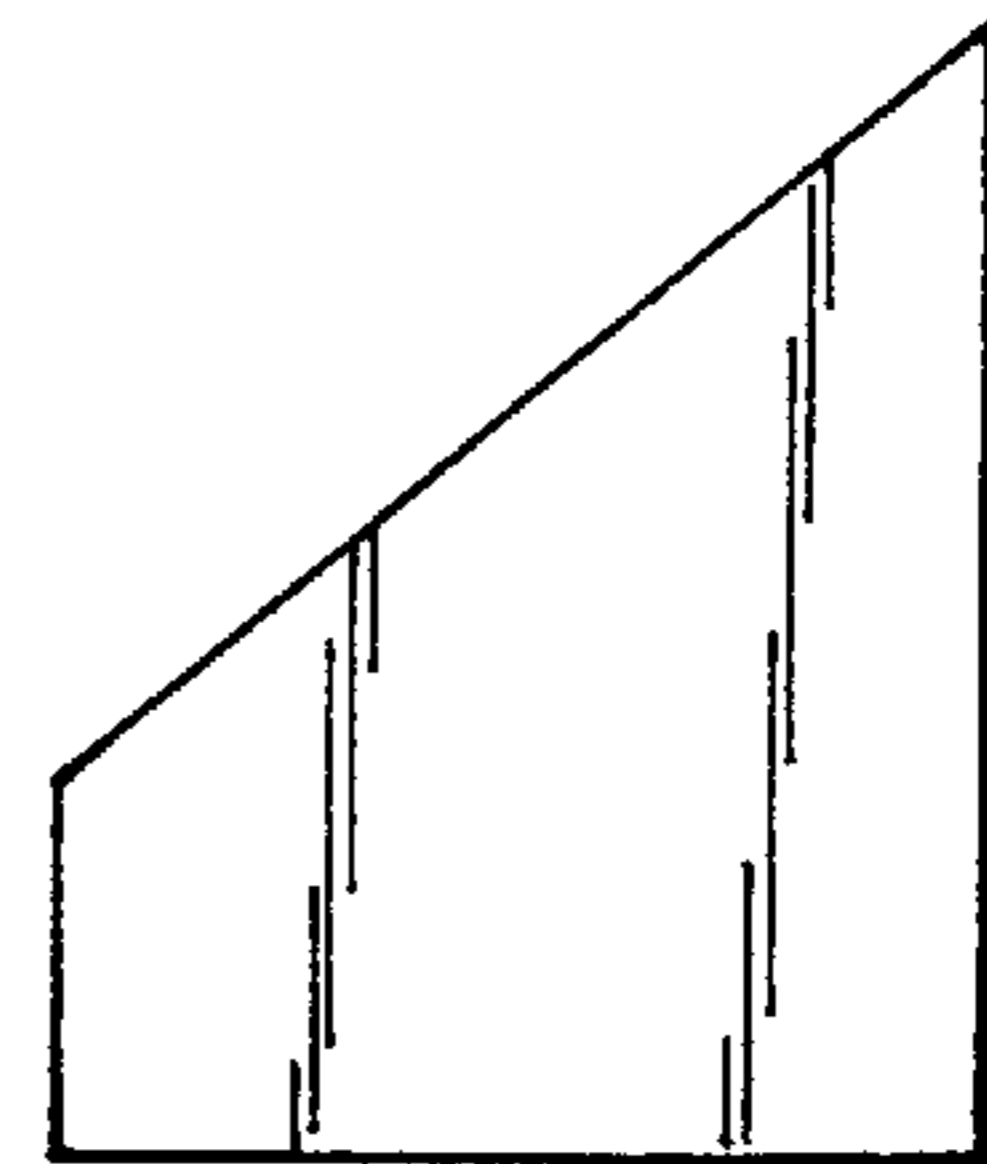
**Fig. 5**



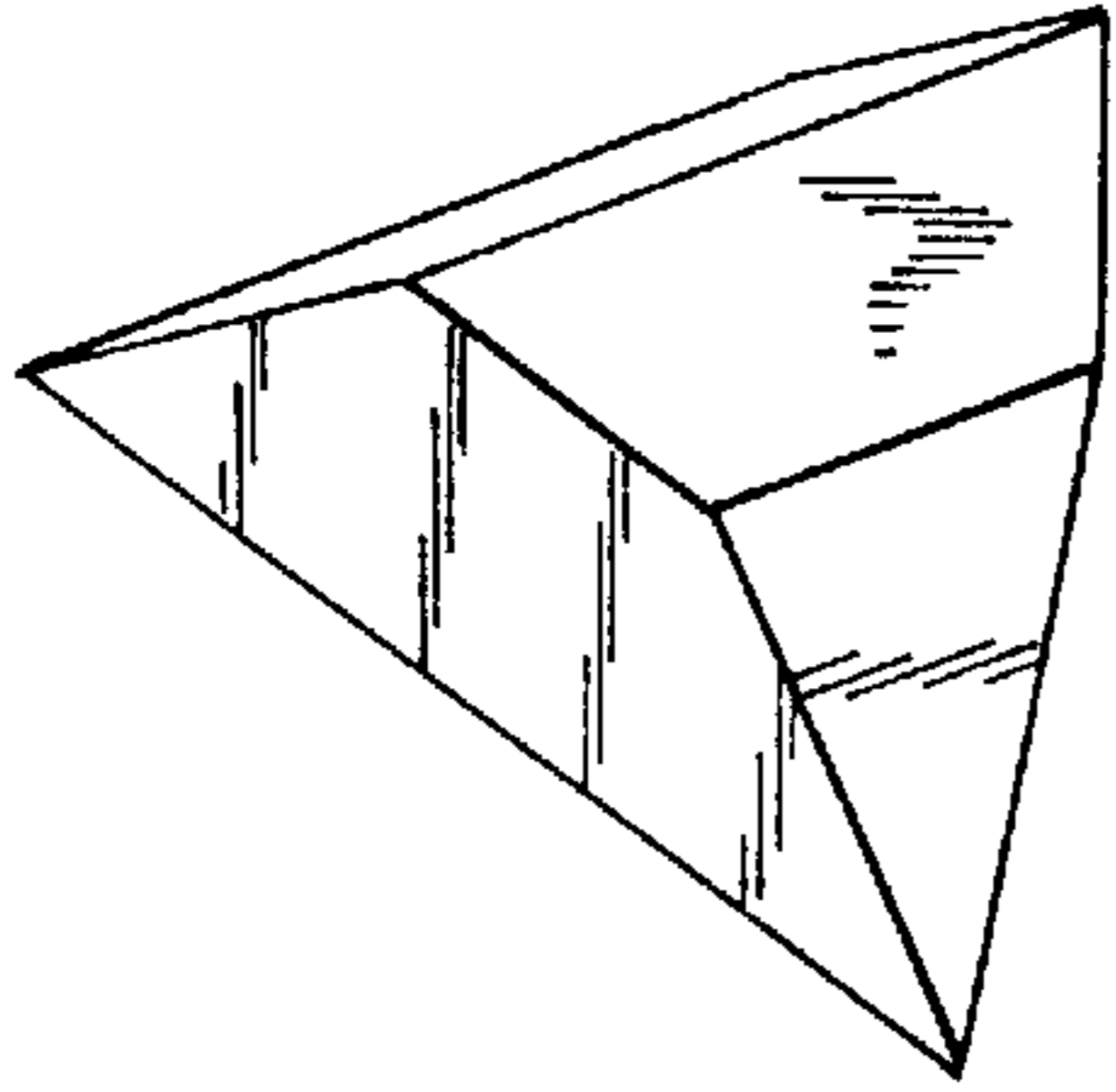
**Fig. 6**



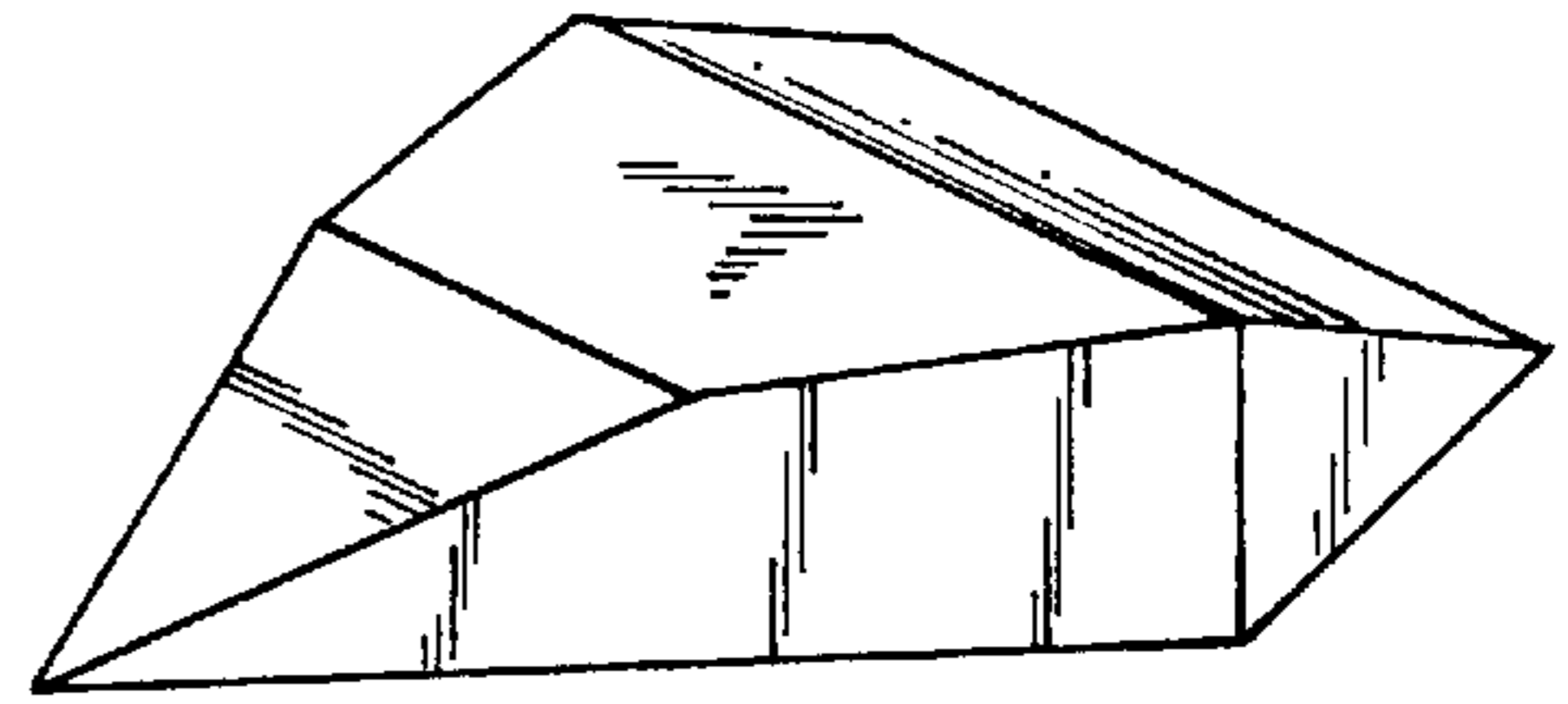
**Fig. 7**



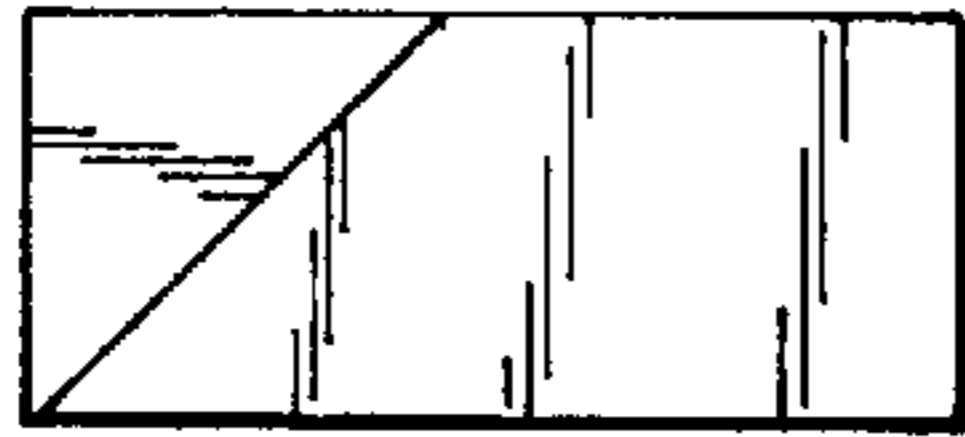
**Fig. 8**



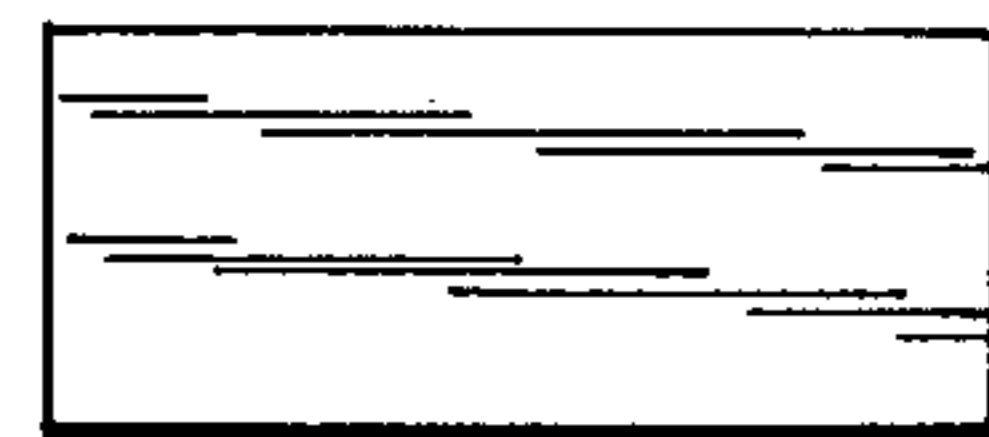
**Fig. 9**



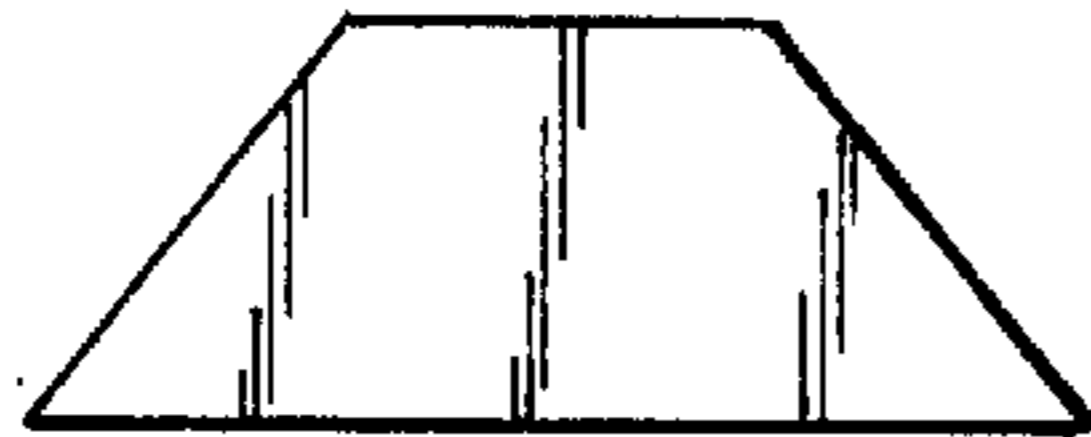
**Fig. 10**



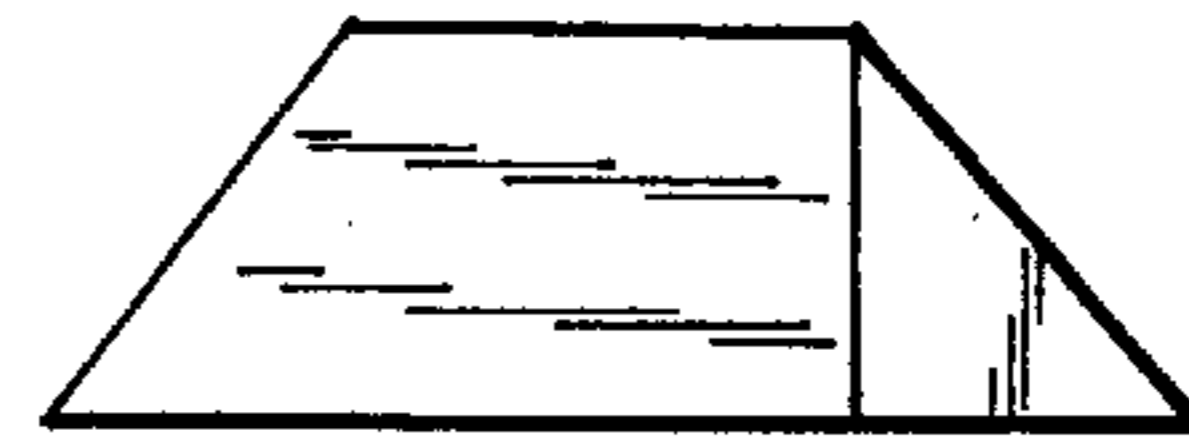
**Fig. 11**



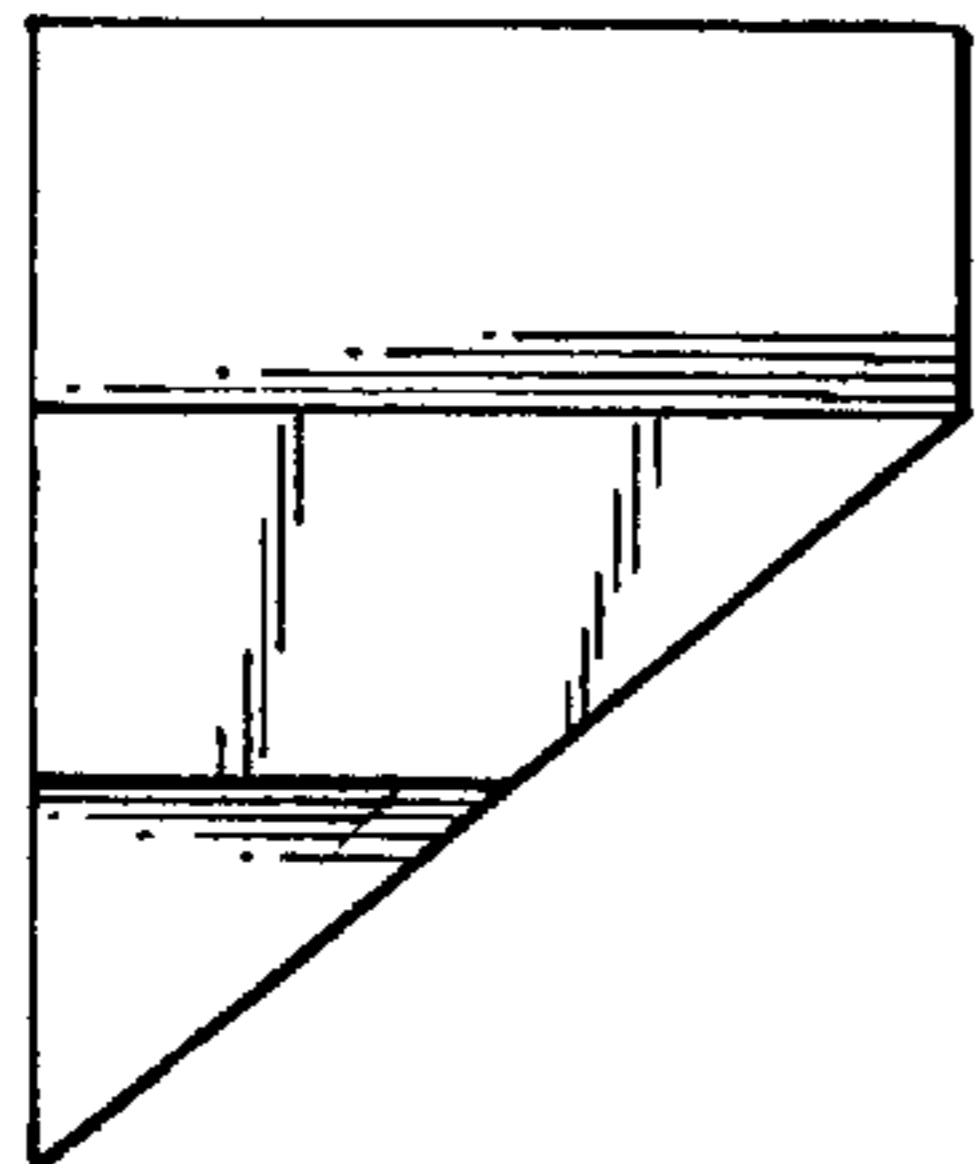
**Fig. 12**



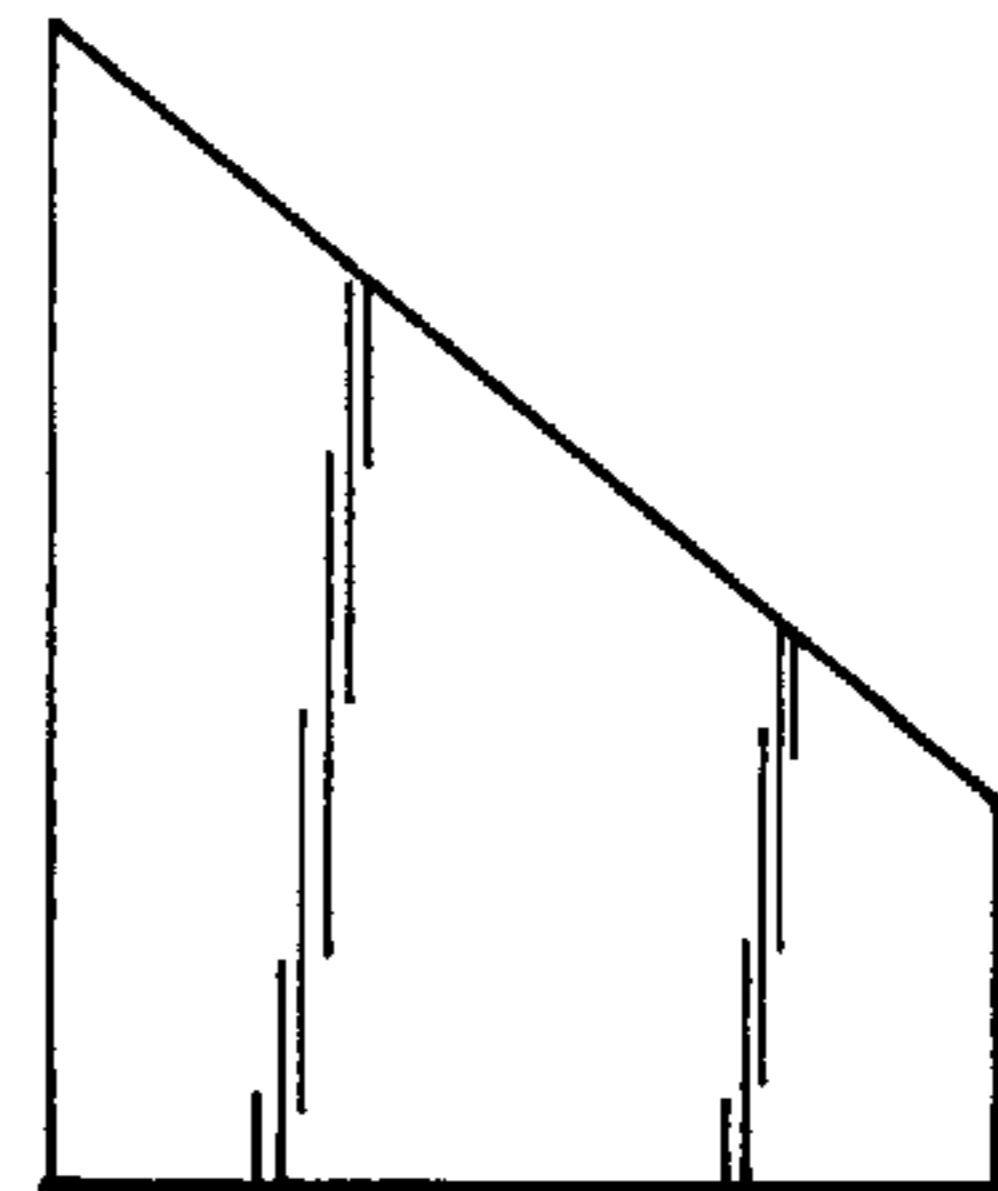
**Fig. 13**



**Fig. 14**



**Fig. 15**



**Fig. 16**