



US00D404068S

# United States Patent [19]

Sekine et al.

[11] Patent Number: **Des. 404,068**

[45] Date of Patent: **\*\*\*Jan. 12, 1999**

[54] **INK TANK FOR PRINTER**

[75] Inventors: **Tetsuya Sekine; Hiroyuki Tokuda,**  
both of Yokohama; **Hiroyuki Ishinaga,**  
Tokyo; **Yuji Kamiyama,** Fujisawa, all  
of Japan

[73] Assignee: **Canon Kabushiki Kaisha,** Tokyo,  
Japan

[\*] Notice: The portion of the term of this patent  
subsequent to Feb. 28, 2009, has been  
disclaimed.

[\*\*] Term: **14 Years**

[21] Appl. No.: **51,621**

[22] Filed: **Mar. 14, 1996**

### [30] Foreign Application Priority Data

Sep. 20, 1995 [JP] Japan ..... 7-27797

[51] **LOC (6) Cl.** ..... **18-02**

[52] **U.S. Cl.** ..... **D18/56; 347/86**

[58] **Field of Search** ..... **D18/43, 56; 347/86-87**

### [56] References Cited

#### U.S. PATENT DOCUMENTS

- D. 355,928 2/1995 Tokuda et al. .... D18/56
- D. 355,930 2/1995 Tokuda et al. .... D18/56
- D. 356,110 3/1995 Tokuda et al. .... D18/56

- D. 359,755 6/1995 Tokuda et al. .... D18/56
- D. 360,895 8/1995 Tokuda et al. .... D18/56
- D. 361,591 8/1995 Tokuda et al. .... D18/56
- D. 367,884 3/1996 Taneya et al. .... D18/56
- D. 371,389 7/1996 Taneya et al. .... D18/56
- 4,771,295 9/1988 Baker et al. .... 347/87
- 5,025,271 6/1991 Baker et al. .... 347/87

#### FOREIGN PATENT DOCUMENTS

- 000419189 3/1991 European Pat. Off. .... 347/87
- 000639461 2/1995 European Pat. Off. .... 347/86
- 36329062 10/1988 Japan ..... 347/87

*Primary Examiner*—Cathy Anne MacCormac  
*Attorney, Agent, or Firm*—Fitzpatrick, Cella, Harper &  
Scinto

### [57] CLAIM

The ornamental design for an ink tank for printer, as shown  
and described.

### DESCRIPTION

FIG. 1 is a front view of an ink tank for printer showing our  
new design;  
FIG. 2 is a rear view thereof;  
FIG. 3 is a top plan view thereof;  
FIG. 4 is a bottom plan view thereof;  
FIG. 5 is a left side view thereof;  
FIG. 6 is a right side view thereof; and,  
FIG. 7 is a perspective view thereof.

**1 Claim, 3 Drawing Sheets**

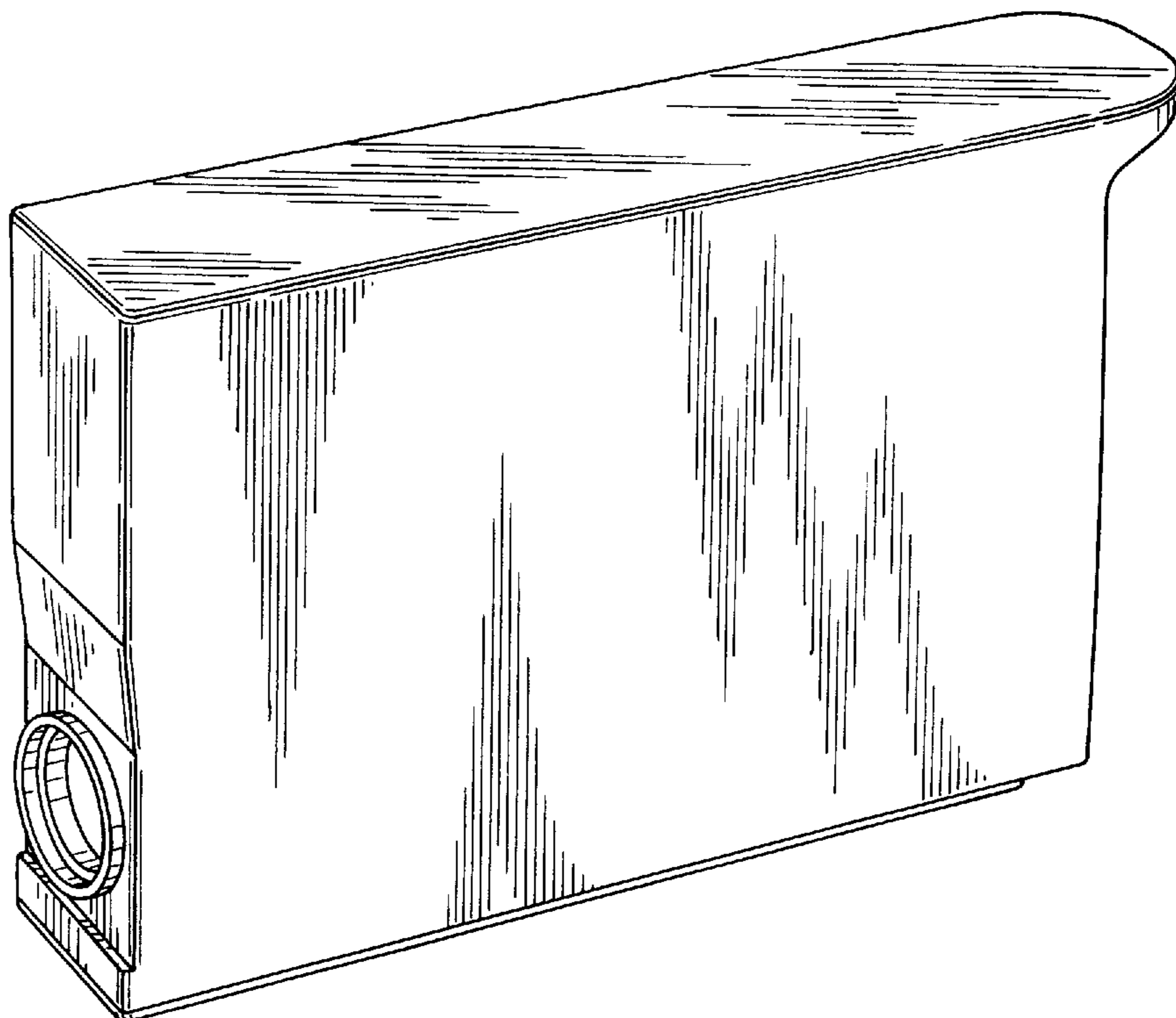

FIG. 1

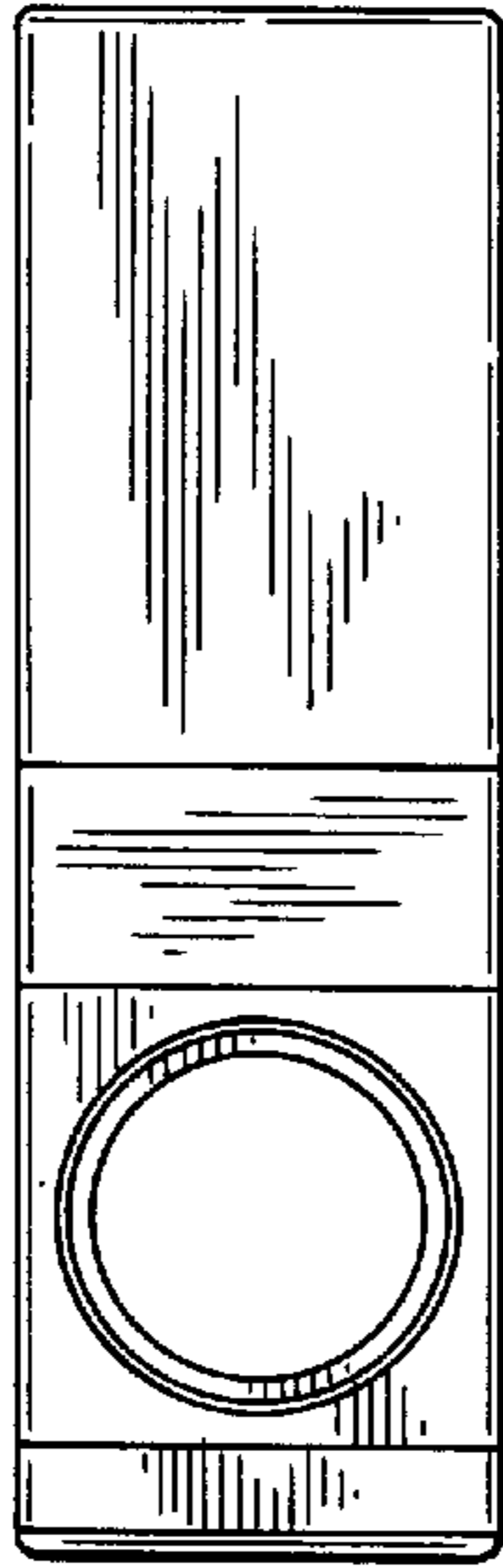

FIG. 2

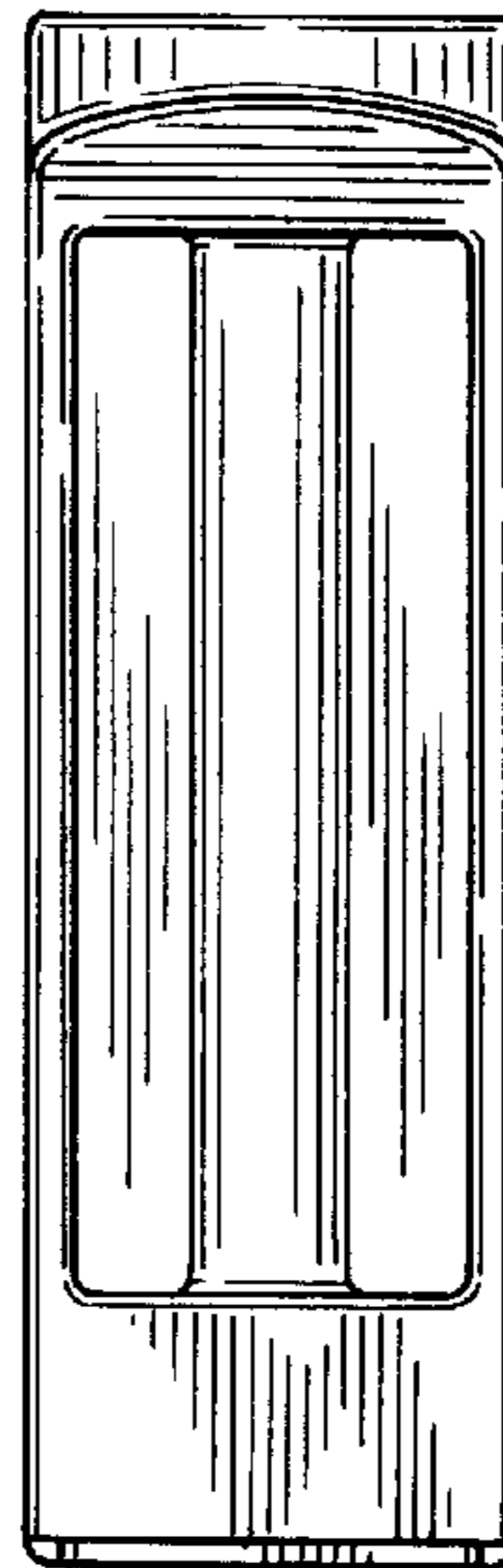

FIG. 3

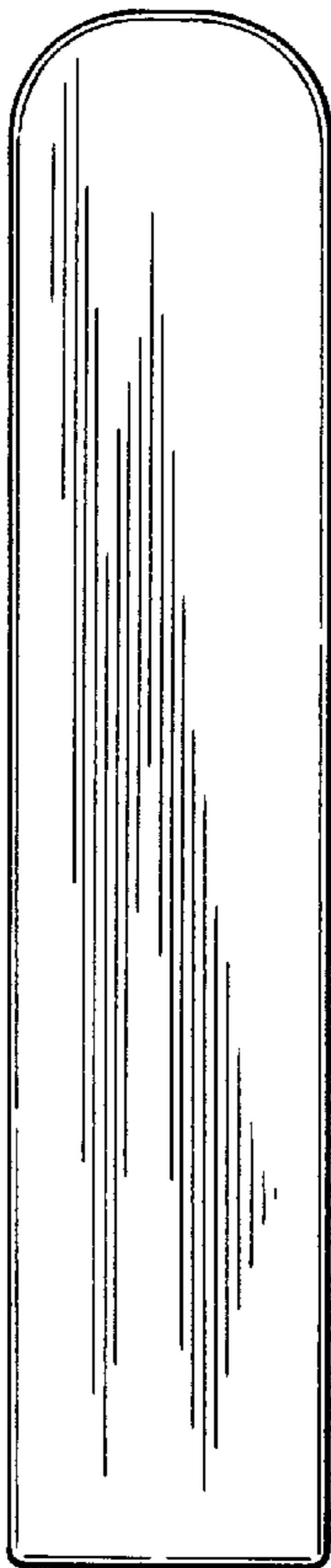
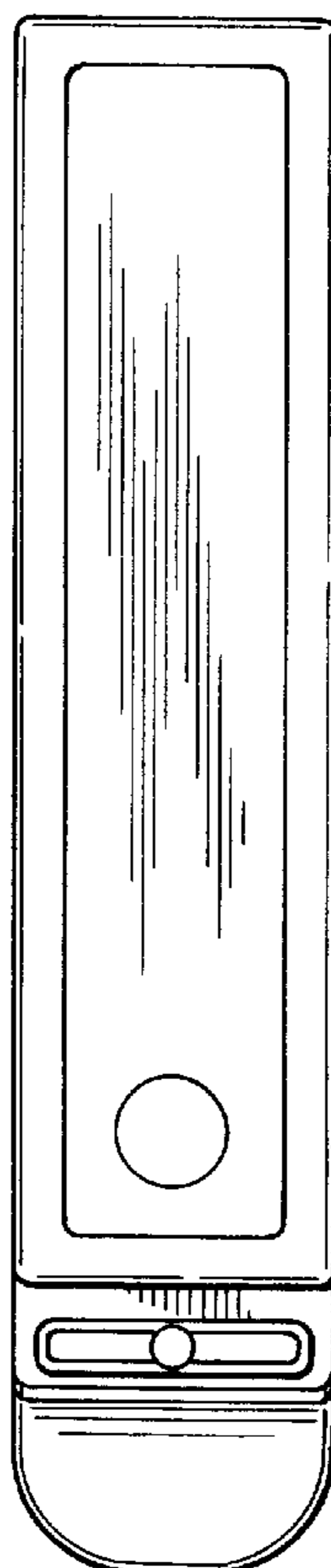
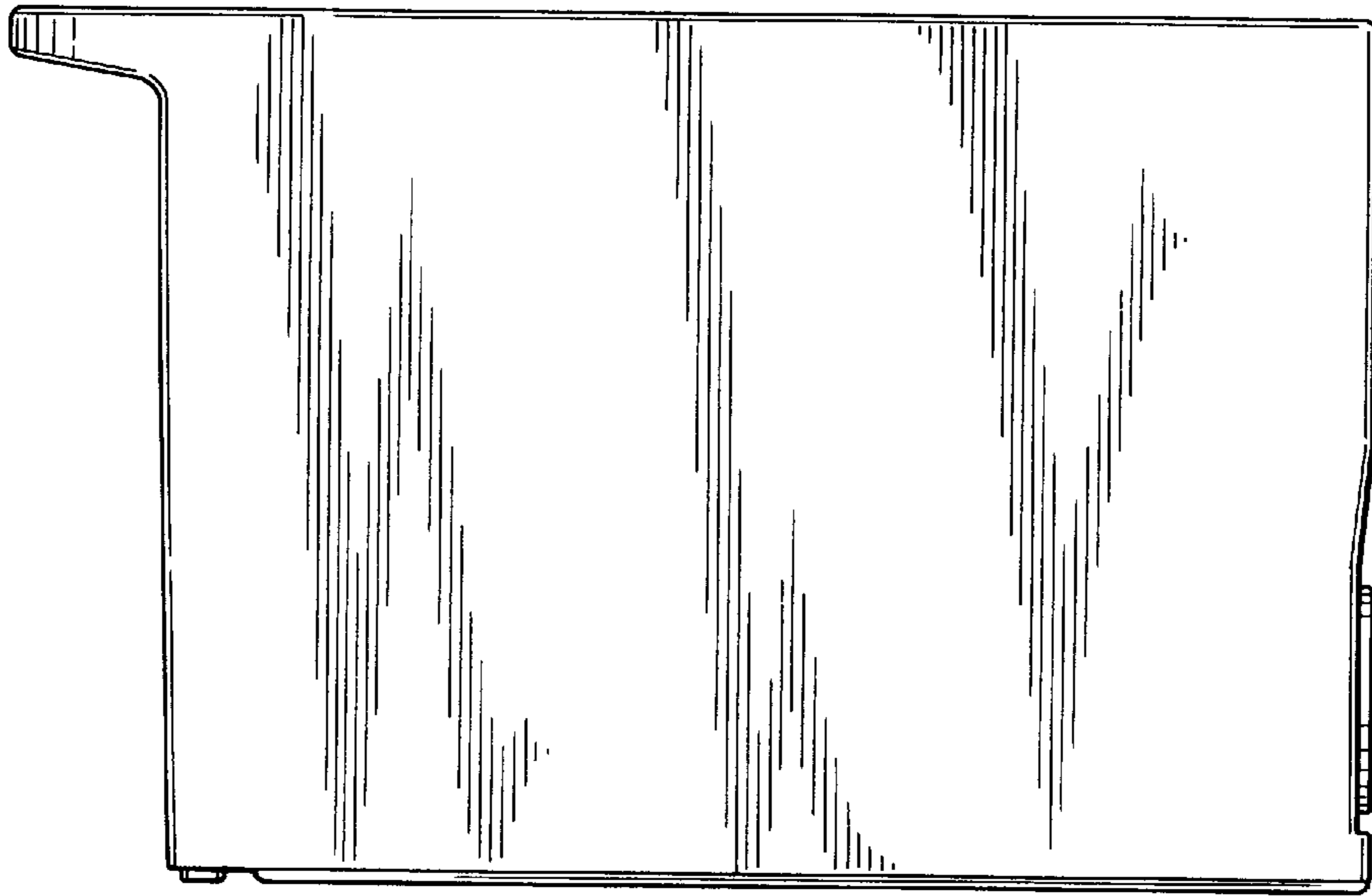

FIG. 4



*FIG. 5*



*FIG. 6*

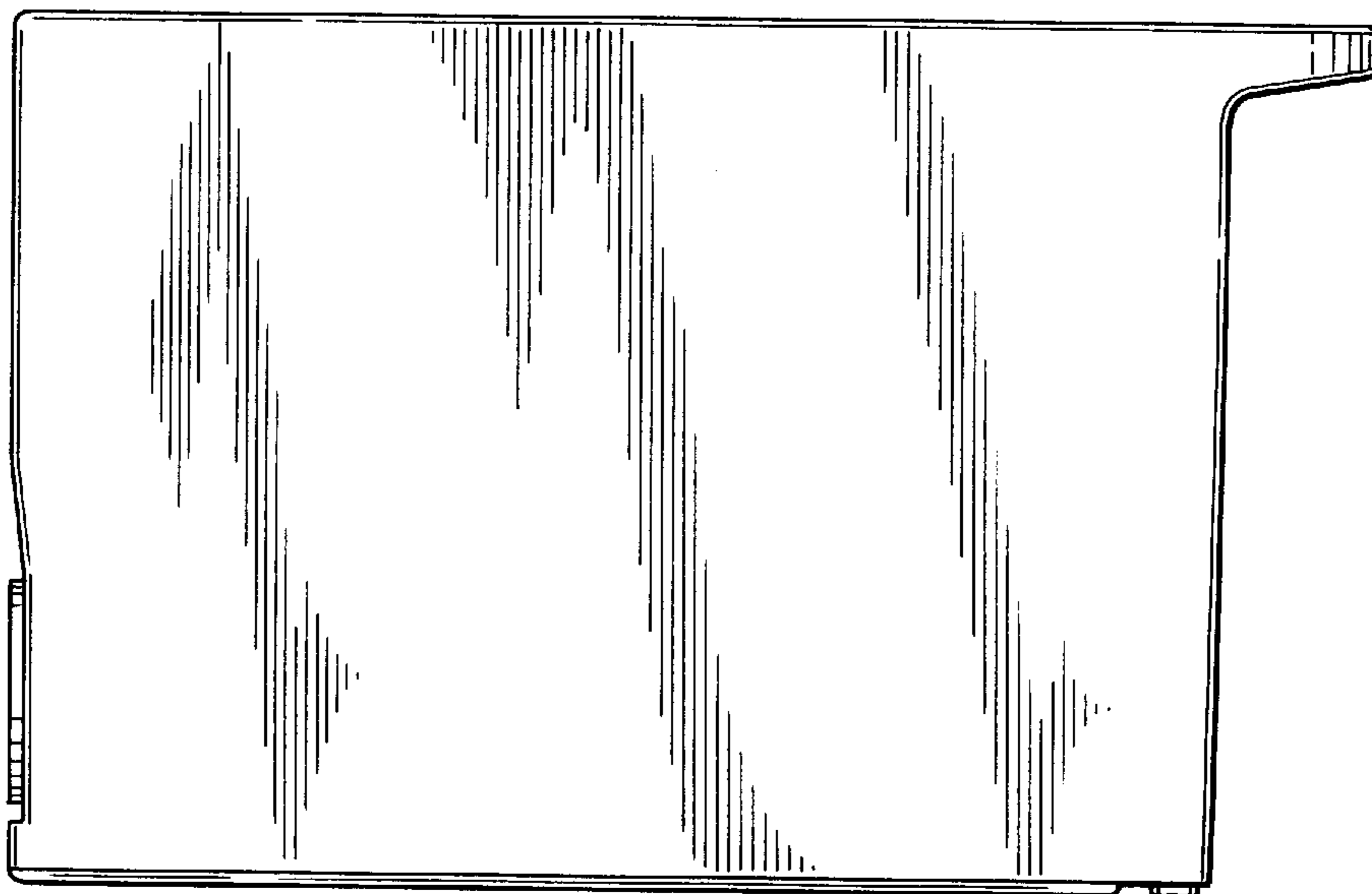

*FIG. 7*

