



US00D404066S

United States Patent [19] Sakata

[11] Patent Number: **Des. 404,066**

[45] Date of Patent: ****Jan. 12, 1999**

[54] **COMPUTER PRINTER**

[75] Inventor: **Osamu Sakata**, Tokyo, Japan

[73] Assignee: **Canon Kabushiki Kaisha**, Tokyo, Japan

[**] Term: **14 Years**

[21] Appl. No.: **74,441**

[22] Filed: **Aug. 4, 1997**

[30] **Foreign Application Priority Data**

Feb. 19, 1997 [JP] Japan 9-4721

[51] **LOC (6) Cl.** **14-02**

[52] **U.S. Cl.** **D18/54; D18/36**

[58] **Field of Search** D18/50, 54-55,
D18/36-37; 400/690-694, 613, 613.1-613.4,
690.1-690.4

[56] **References Cited**

U.S. PATENT DOCUMENTS

- D. 265,656 8/1982 Matsushima D18/36
- D. 320,808 10/1991 Ishida D18/37
- D. 328,609 8/1992 Isida D18/36

- D. 343,413 1/1994 Arakaki et al. D18/55
- D. 350,978 9/1994 Minakawa D18/50
- D. 352,054 11/1994 Yomo et al. D18/36
- D. 352,307 11/1994 Gassett et al. D18/55
- D. 374,454 10/1996 Naraki et al. D19/36
- D. 376,171 12/1996 Senshiki D18/55
- D. 380,204 6/1997 Kogoh et al. D18/50
- D. 384,370 9/1997 Kobayashi D18/55

Primary Examiner—Cathy Anne MacCormac
Attorney, Agent, or Firm—Fitzpatrick, Cella, Harper & Scinto

[57] **CLAIM**

The ornamental design for a computer printer, as shown and described.

DESCRIPTION

FIG. 1 is a front view of a computer printer showing my new design;
FIG. 2 is a rear view thereof;
FIG. 3 is a top plan view thereof;
FIG. 4 is a bottom plan view thereof;
FIG. 5 is a left side view thereof;
FIG. 6 is a right side view thereof; and,
FIG. 7 is a perspective view thereof.

1 Claim, 4 Drawing Sheets

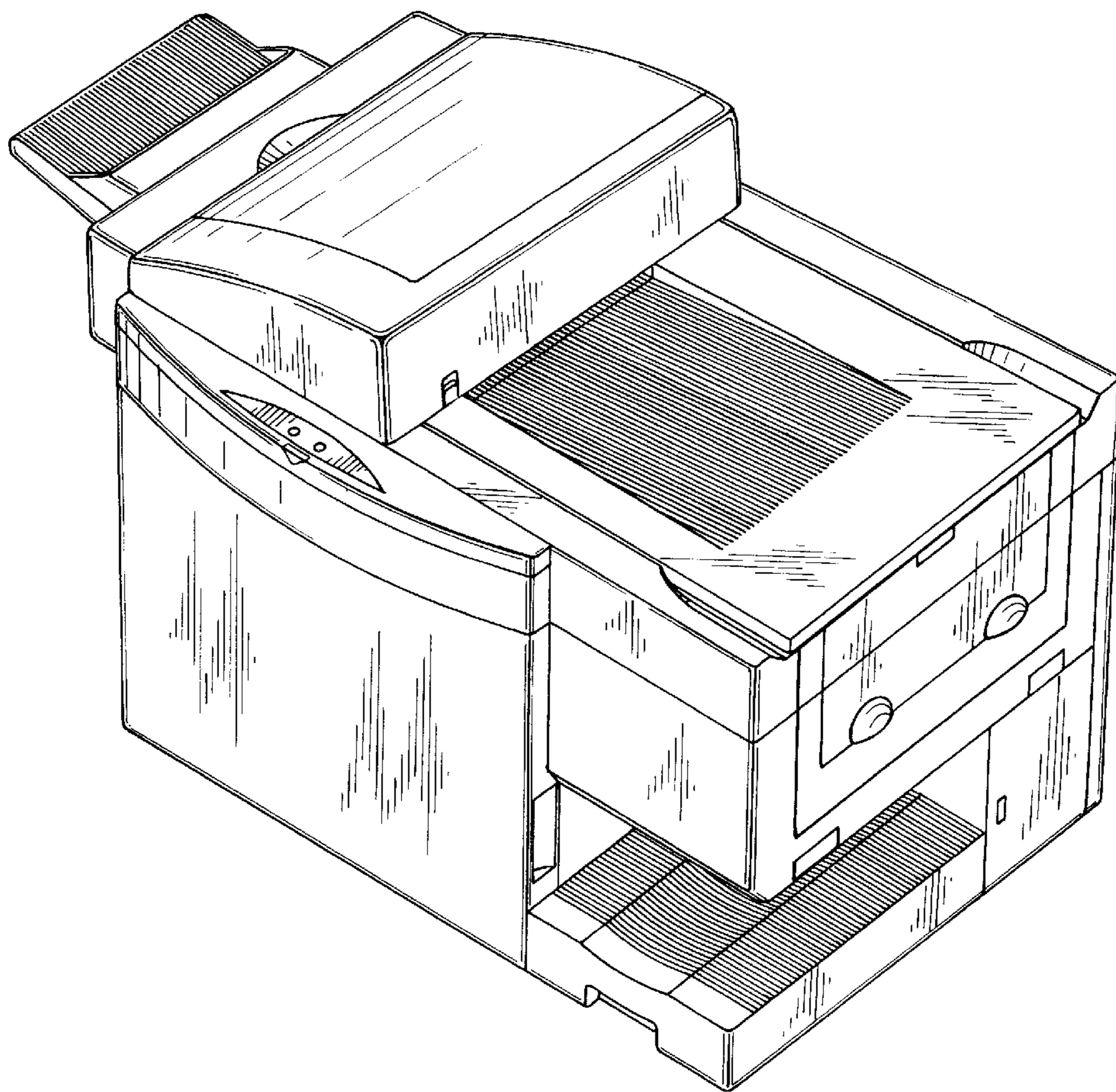

FIG. 1

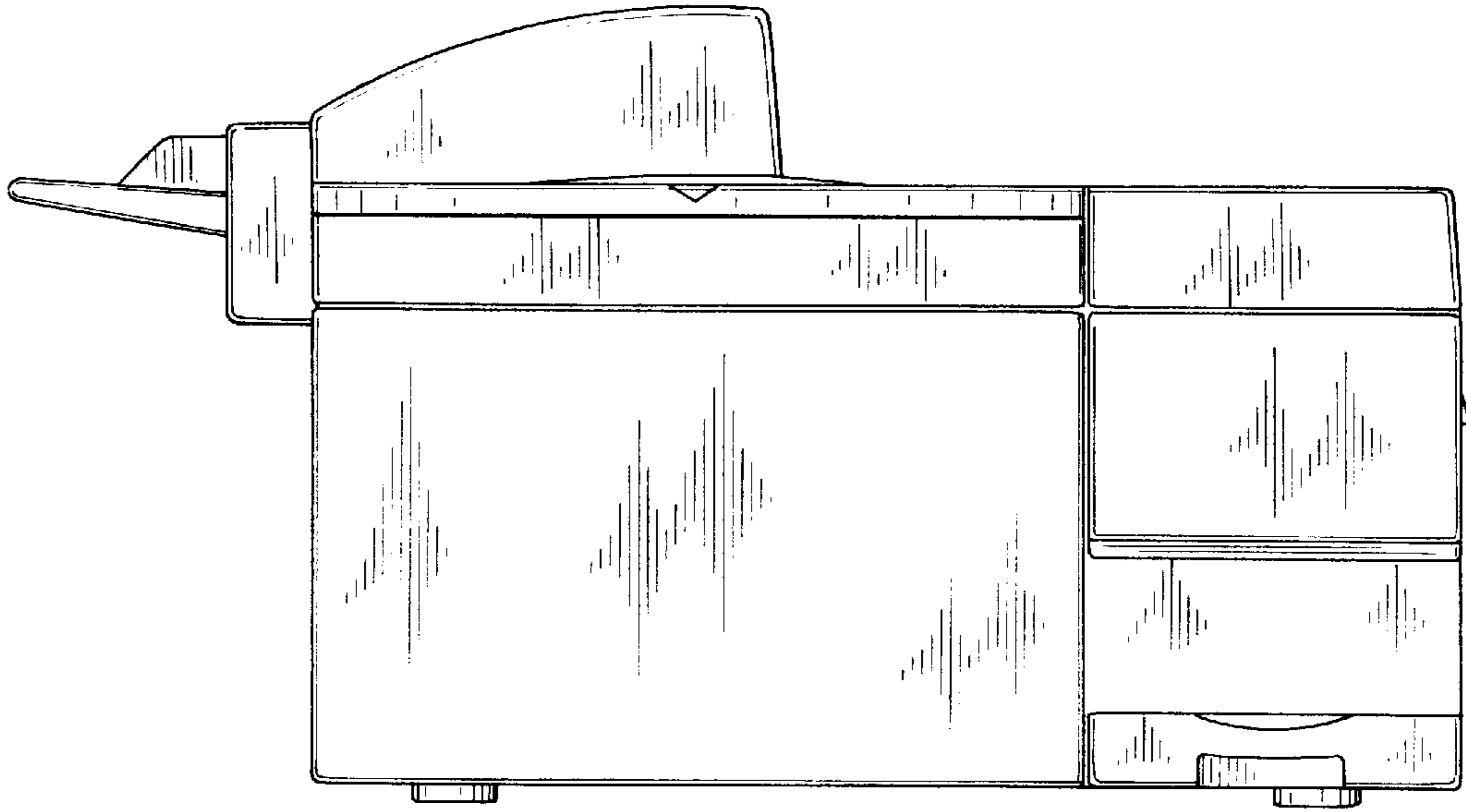

FIG. 2

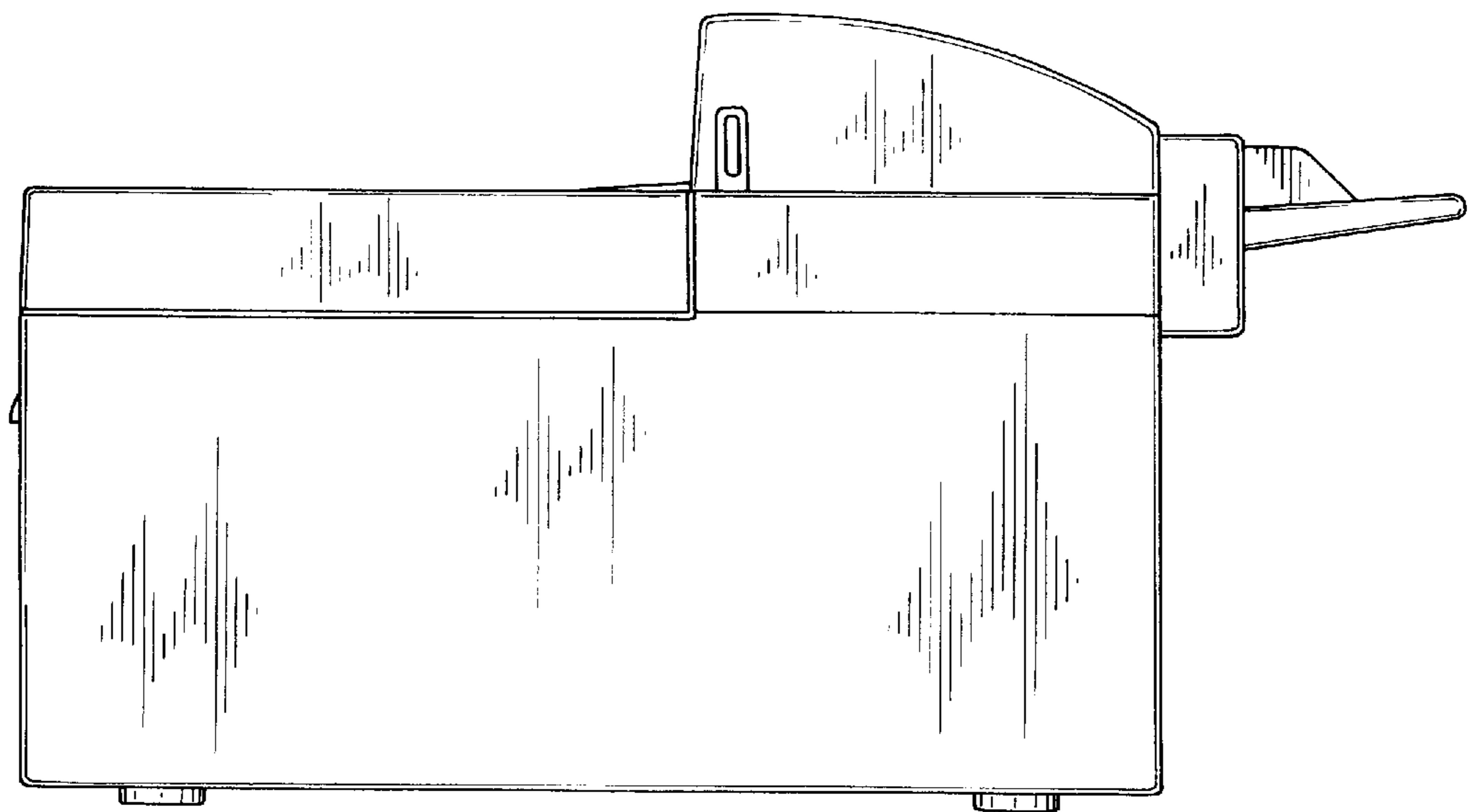

FIG. 3

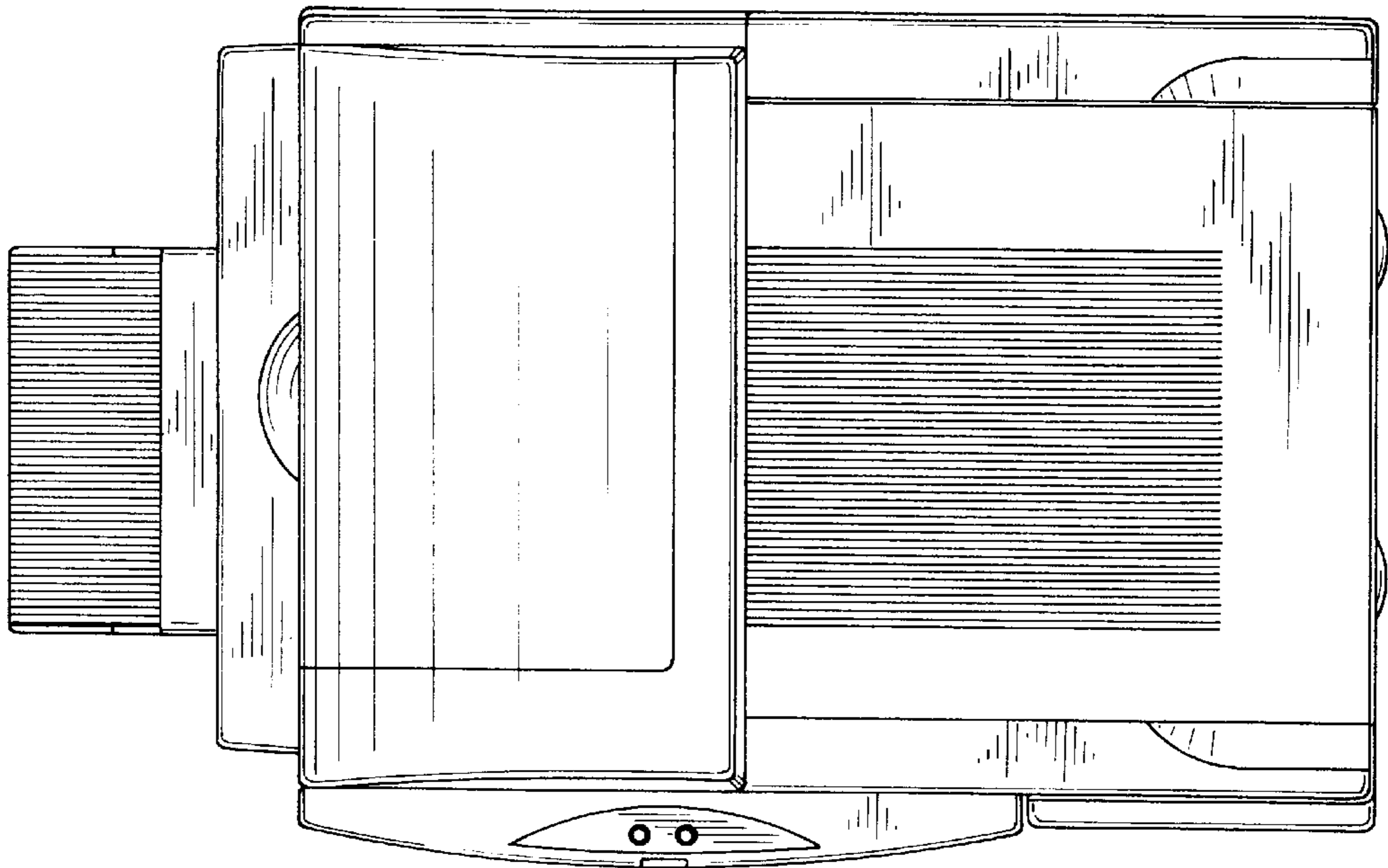

FIG. 4

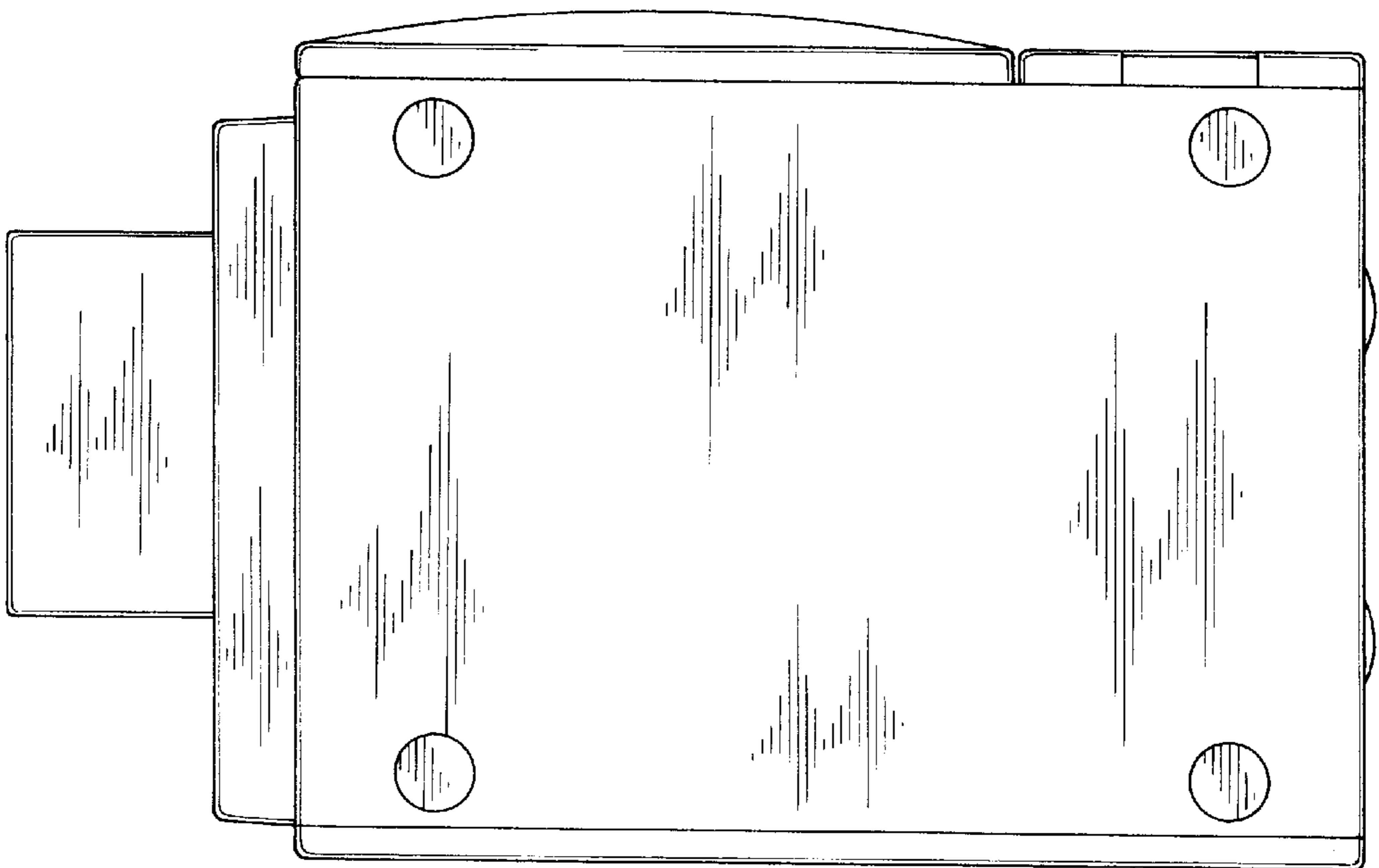

FIG. 5

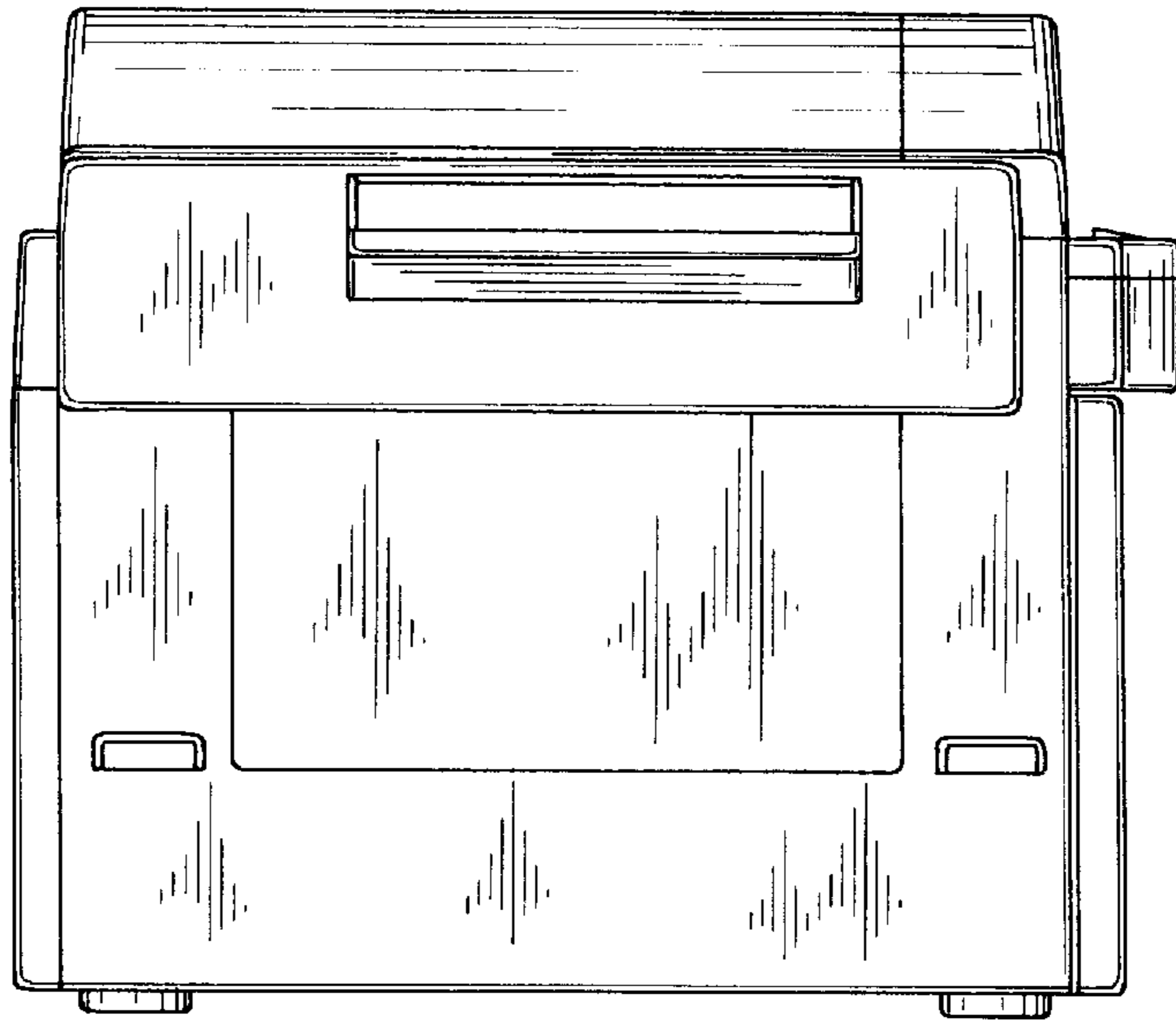

FIG. 6

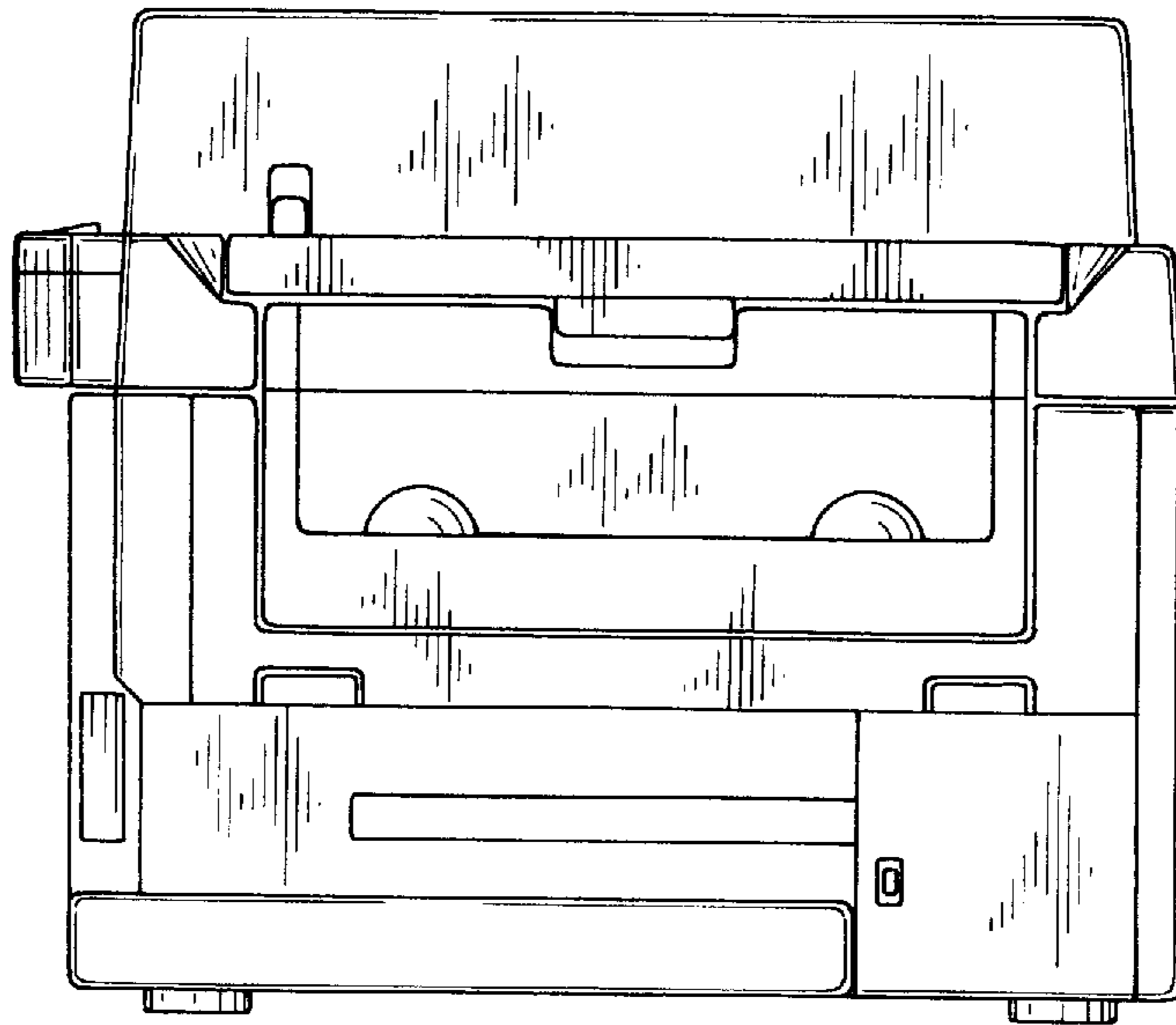

FIG. 7

