



US00D403983S

# United States Patent [19]

Weder et al.

[11] Patent Number: Des. 403,983

[45] Date of Patent: \*\*Jan. 12, 1999

[54] FLOWER POT COVER

[75] Inventors: Donald E. Weder; Joseph G. Straeter, both of Highland, Ill.

[73] Assignee: Southpac Trust International, Inc.

[\*\*] Term: 14 Years

[21] Appl. No.: 65,492

[22] Filed: Jan. 21, 1997

### Related U.S. Application Data

[62] Division of Ser. No. 46,628, Oct. 18, 1995, Pat. No. Des. 380,411, which is a division of Ser. No. 4,296, Feb. 1, 1993, Pat. No. Des. 363,898, which is a continuation-in-part of Ser. No. 782,237, Oct. 18, 1991, Pat. No. Des. 349,076, which is a continuation-in-part of Ser. No. 617,454, Nov. 21, 1990, abandoned, Ser. No. 411,249, Sep. 22, 1989, Pat. No. Des. 358,113, Ser. No. 411,247, Sep. 22, 1989, abandoned, and Ser. No. 411,245, Sep. 22, 1989, abandoned.

[51] LOC (6) Cl. .... 11-02

[52] U.S. Cl. .... D11/164

[58] Field of Search ..... D11/143, 149, D11/152-156, 164, 89, 90; 47/66, 72; 206/423; 215/100.5; 229/1.5 R, 1.5 B, 4.5, 108, 108.1, 109, 110, 87.01, 922, 930, 186, 189; 428/27, 35.1, 24, 542.6; 338/122; D9/346, 428-431; D27/102, 133; D26/128-136; D19/96; D7/540, 584, 586, 587, 354

### [56] References Cited

#### U.S. PATENT DOCUMENTS

D. 38,012	5/1906	Owens	.....	D11/153 X
D. 125,195	2/1941	Winsick	.....	D9/305
D. 239,192	3/1976	Wiles et al.	.....	D35/3 A
D. 254,659	4/1980	Karotseris	.....	D11/143
D. 292,182	10/1987	Weder et al.	.....	D11/164
D. 293,224	12/1987	Weder et al.	.....	D11/164
D. 293,774	1/1988	Weder et al.	.....	D11/164
D. 318,030	7/1991	Weder et al.	.....	D11/164
D. 318,635	7/1991	Weder et al.	.....	D11/164
D. 322,403	12/1991	Eaton	.....	D9/429
D. 324,659	3/1992	Stehouwer	.....	D11/143
D. 349,076	7/1994	Weder et al.	.....	D11/164
D. 355,392	2/1995	Weder et al.	.....	D11/164

D. 360,382	7/1995	Weder et al.	.....	D11/164
D. 361,293	8/1995	Weder et al.	.....	D11/164
D. 361,298	8/1995	Weder et al.	.....	D11/164
D. 361,961	9/1995	Weder et al.	.....	D11/164
D. 363,898	11/1995	Weder et al.	.....	D11/164
D. 364,119	11/1995	Weder et al.	.....	D11/164
1,520,647	12/1924	Hennegan	.....	47/72 X
1,794,212	2/1931	Snyder	.....	47/72
1,924,926	8/1933	Gray	.....	65/53
1,951,642	3/1934	Augustin et al.	.....	47/34
2,317,067	4/1943	Knaust	.....	229/117.12
2,355,559	8/1944	Renner	.....	229/8
2,827,217	3/1958	Clement	.....	229/1.5
3,443,741	5/1969	Stockdale	.....	229/51
4,043,077	8/1977	Stonehocker	.....	47/66
4,216,620	8/1980	Weder et al.	.....	47/72
4,300,312	11/1981	Weder et al.	.....	47/72
4,712,725	12/1987	Moore	.....	229/8
4,733,521	3/1988	Weder et al.	.....	53/580
5,076,011	12/1991	Stehouwer	.....	47/72

### FOREIGN PATENT DOCUMENTS

2489126	3/1982	France	.	
2603159	8/1986	France	.	
153402	of 1903	Germany	.....	47/72
1115	of 1887	Sweden	.....	47/72
17930	5/1899	Switzerland	.....	47/72
54263	7/1912	Switzerland	.....	47/72

### OTHER PUBLICATIONS

Exhibit A—"The Simple Solution For Those Peak Volume Periods", (4 pages), a brochure published by Highland Supply Corporation, 1111 Sixth St., Highland, Illinois 62249, ©1989.

Exhibit B—"The Glass of Frederick Carder", ©1971, by P. V. Gardner, showing various styles of glass basket-like vases or containers.

Primary Examiner—Jeffrey Asch  
Attorney, Agent, or Firm—Dunlap & Coddling, P.C.

### [57] CLAIM

The ornamental design for a flower pot cover, as shown and described.

### DESCRIPTION

FIG. 1 is a perspective view of our new flower pot cover design;

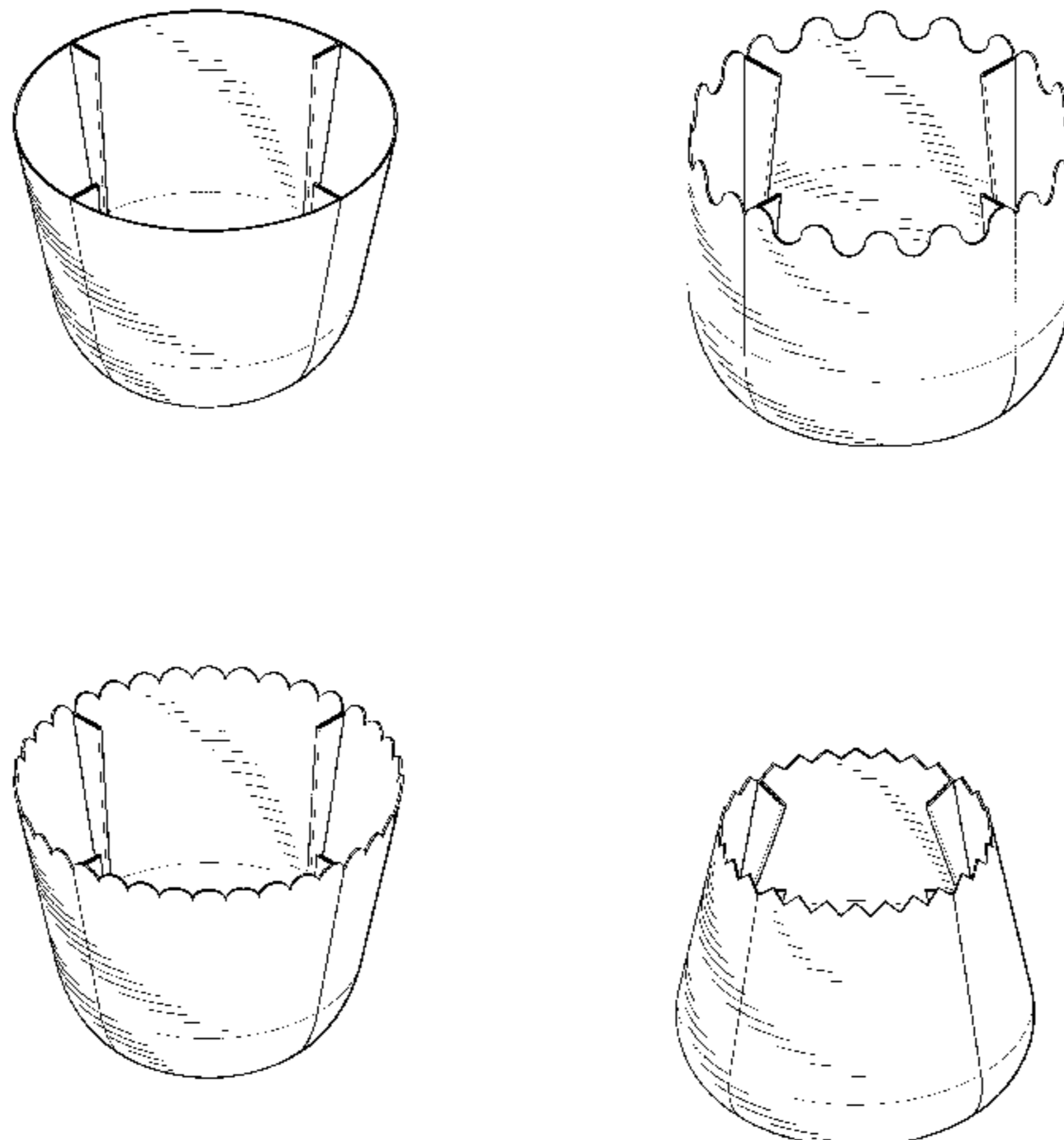

FIG. 2 is a side elevational view thereof;  
FIG. 3 is a top plan view thereof;  
FIG. 4 is a bottom plan view thereof;  
FIG. 5 is a perspective view of a second embodiment of our new flower pot cover design;  
FIG. 6 is a side elevational view thereof;  
FIG. 7 is a top plan view thereof;  
FIG. 8 is a bottom plan view thereof;  
FIG. 9 is a perspective view of a third embodiment of our new flower pot cover design;  
FIG. 10 is a side elevational view thereof;  
FIG. 11 is a top plan view thereof;  
FIG. 12 is a bottom plan view thereof;  
FIG. 13 is a perspective view of a fourth embodiment of our new flower pot cover design;  
FIG. 14 is a side elevational view thereof;  
FIG. 15 is a top plan view thereof;  
FIG. 16 is a bottom plan view thereof;  
FIG. 17 is a perspective view of a fifth embodiment of our new flower pot cover design;  
FIG. 18 is a side elevational view thereof;  
FIG. 19 is a top plan view thereof;  
FIG. 20 is a bottom plan view thereof;  
FIG. 21 is a perspective view of a sixth embodiment of our new flower pot cover design;  
FIG. 22 is a side elevational view thereof;  
FIG. 23 is a top plan view thereof;  
FIG. 24 is a bottom plan view thereof;  
FIG. 25 is a perspective view of a seventh embodiment of our new flower pot cover design;  
FIG. 26 is a side elevational view thereof;

FIG. 27 is a top plan view thereof;  
FIG. 28 is a bottom plan view thereof;  
FIG. 29 is a perspective view of a eighth embodiment of our new flower pot cover design;  
FIG. 30 is a side elevational view thereof;  
FIG. 31 is a top plan view thereof;  
FIG. 32 is a bottom plan view thereof;  
FIG. 33 is a perspective view of a ninth embodiment of our new flower pot cover design;  
FIG. 34 is a side elevational view thereof;  
FIG. 35 is a top plan view thereof;  
FIG. 36 is a bottom plan view thereof;  
FIG. 37 is a perspective view of a tenth embodiment of our new flower pot cover design;  
FIG. 38 is a side elevational view thereof;  
FIG. 39 is a top plan view thereof;  
FIG. 40 is a bottom plan view thereof;  
FIG. 41 is a perspective view of an eleventh embodiment of our new flower pot cover design;  
FIG. 42 is a side elevational view thereof;  
FIG. 43 is a top plan view thereof;  
FIG. 44 is a bottom plan view thereof;  
FIG. 45 is a perspective view of a twelfth embodiment of our new flower pot cover design;  
FIG. 46 is a side elevational view thereof;  
FIG. 47 is a top plan view thereof; and,  
FIG. 48 is a bottom plan view thereof.  
The flower pot cover has no substantial thickness.

**1 Claim, 12 Drawing Sheets**

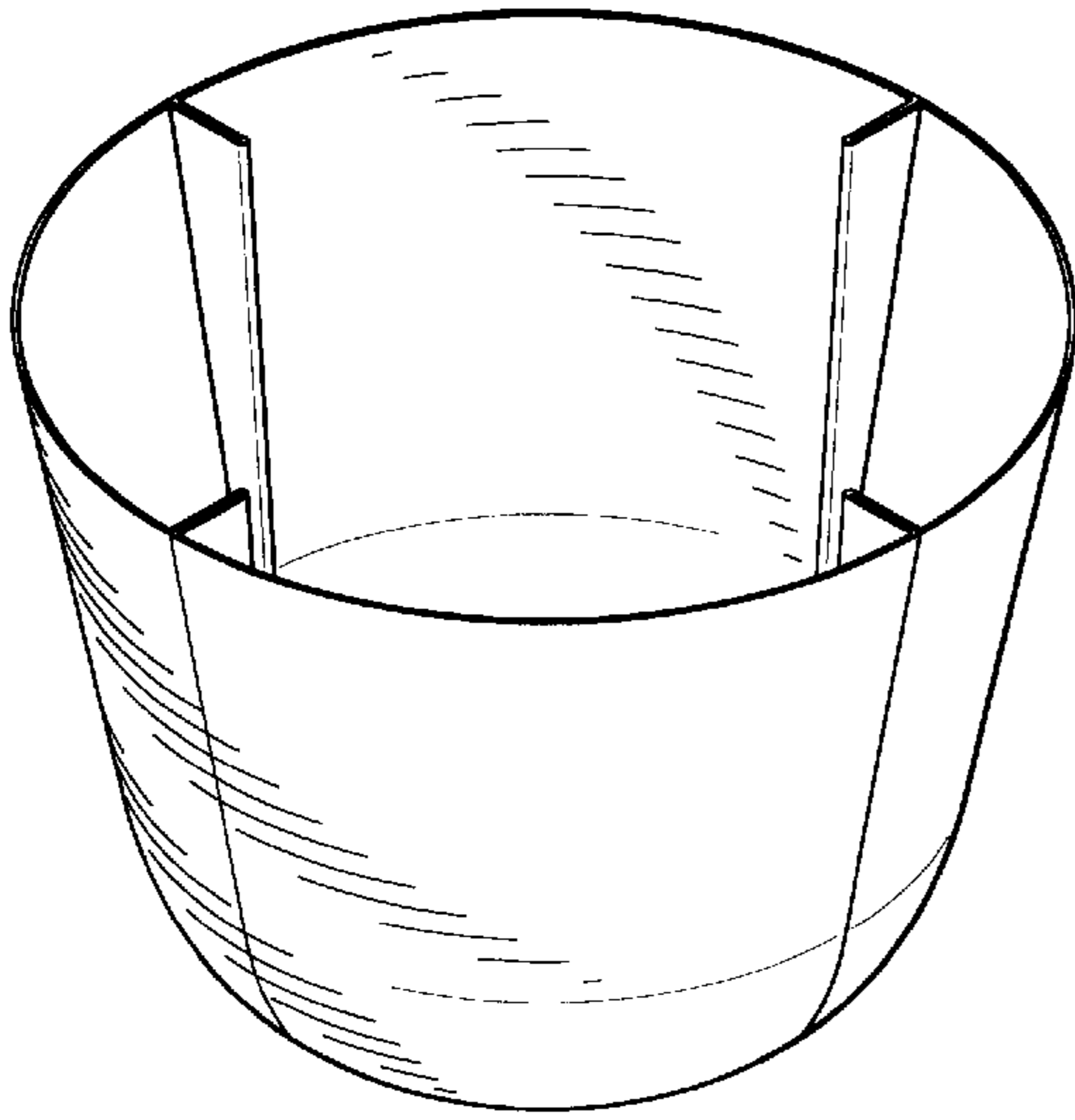

FIG. 1

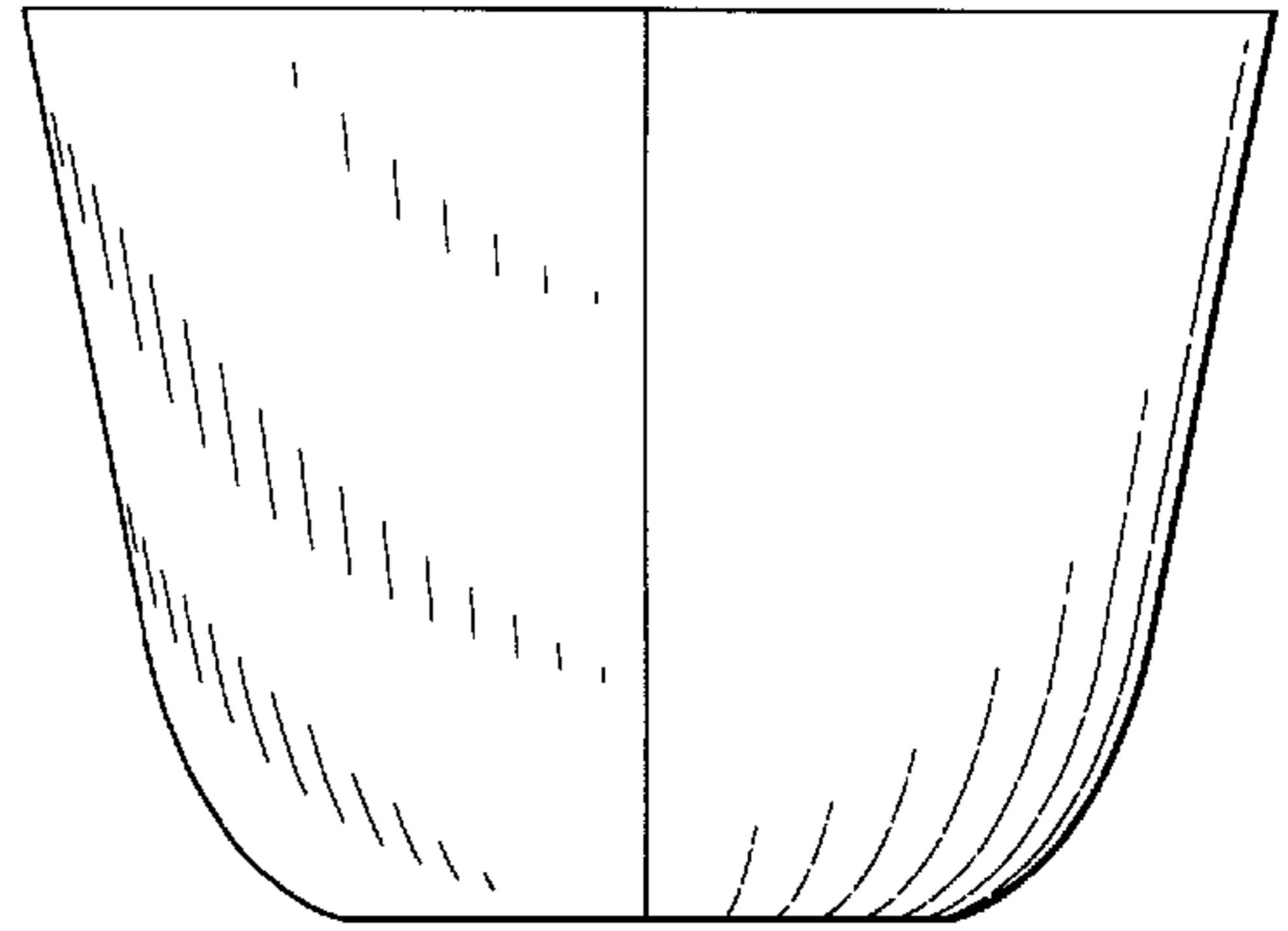

FIG. 2

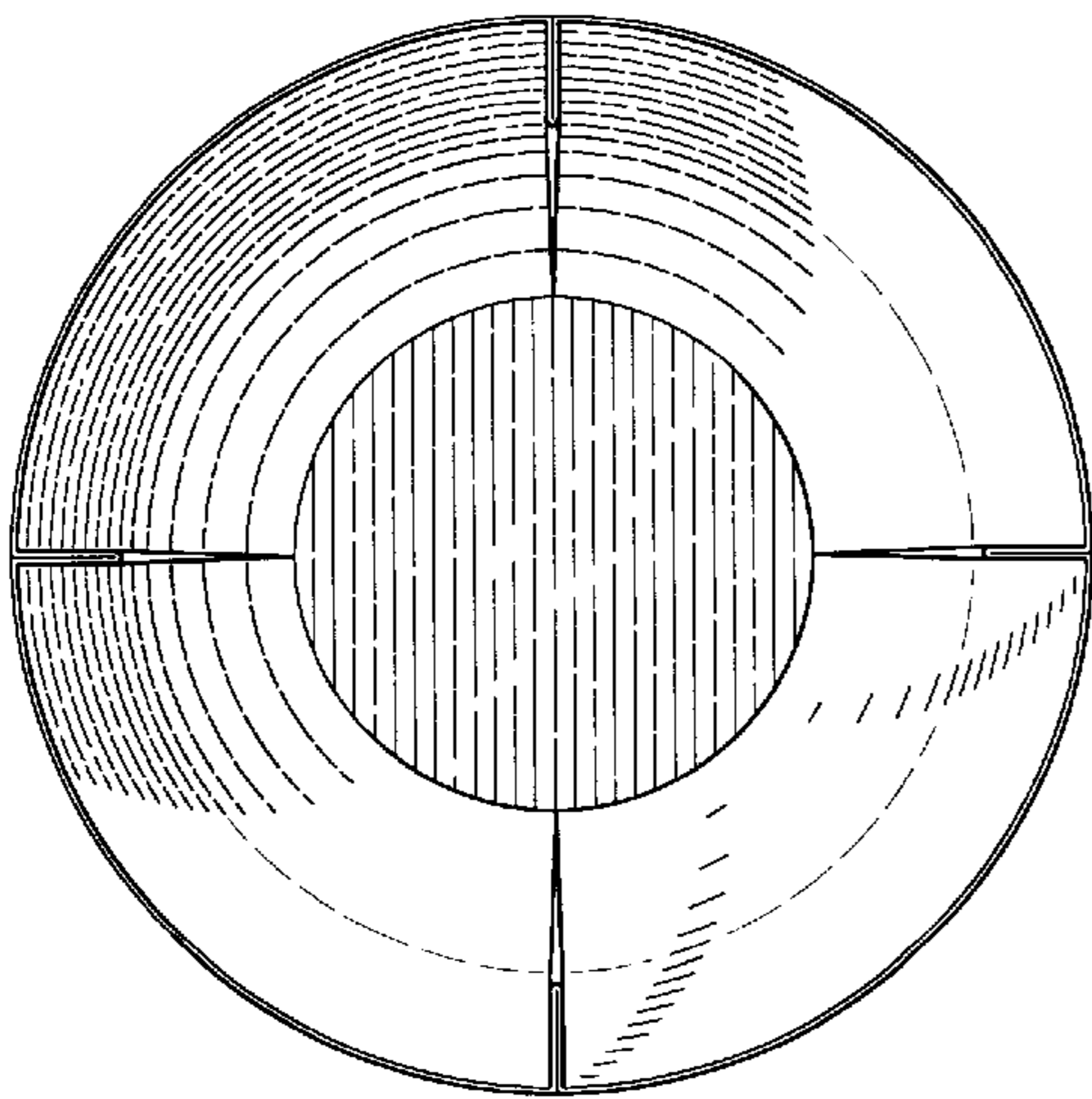

FIG. 3

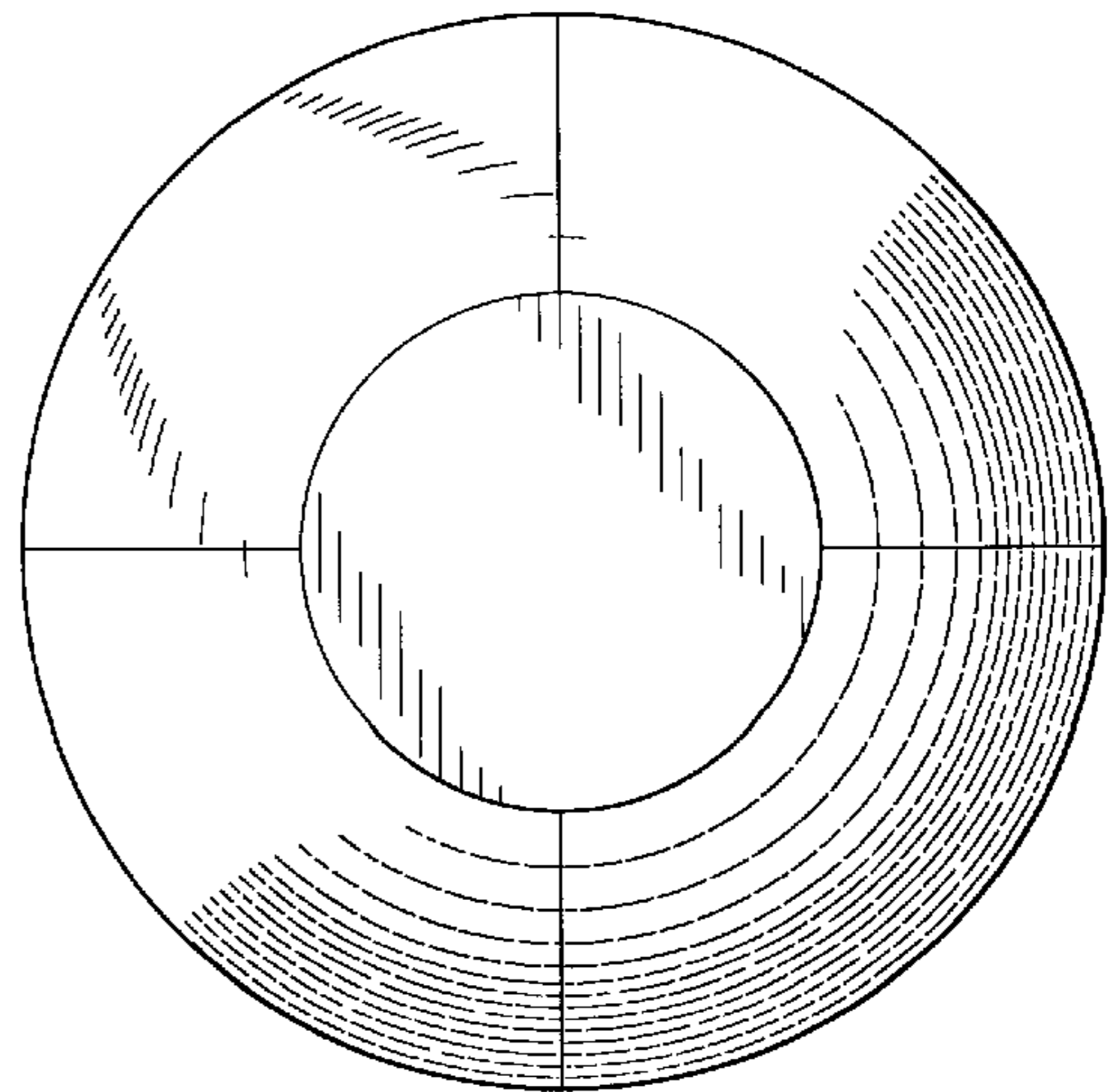

FIG. 4

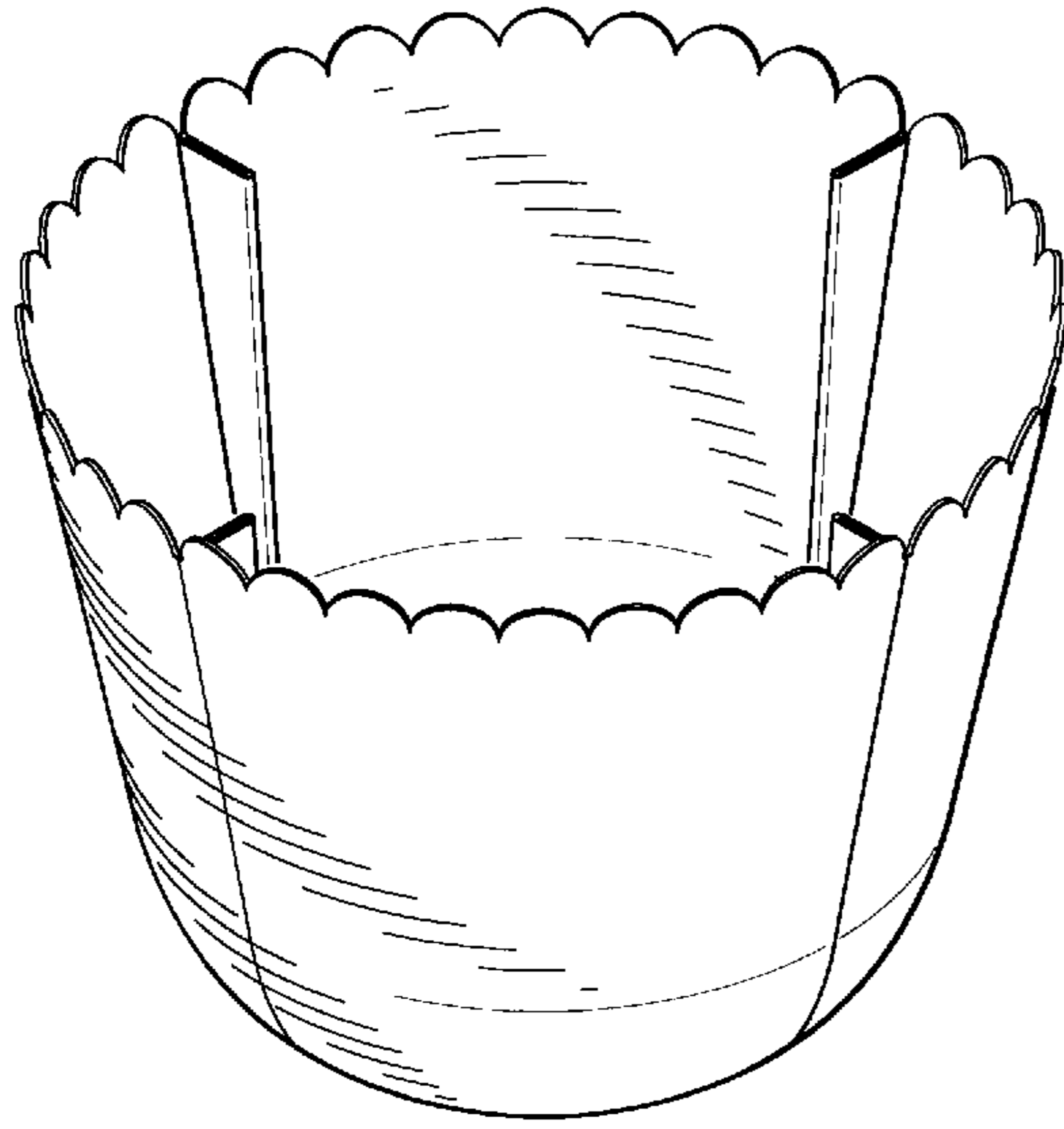

FIG. 5

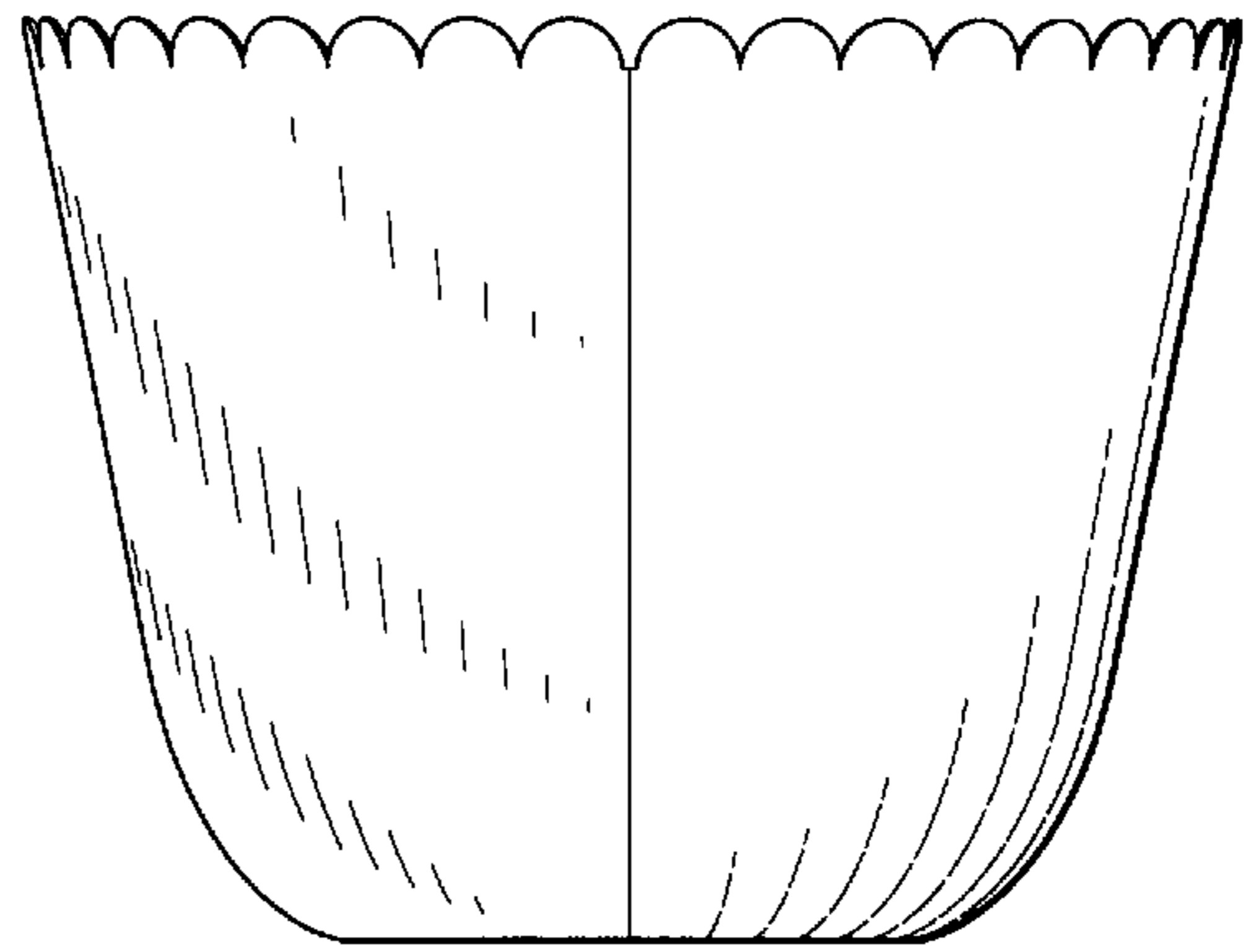

FIG. 6

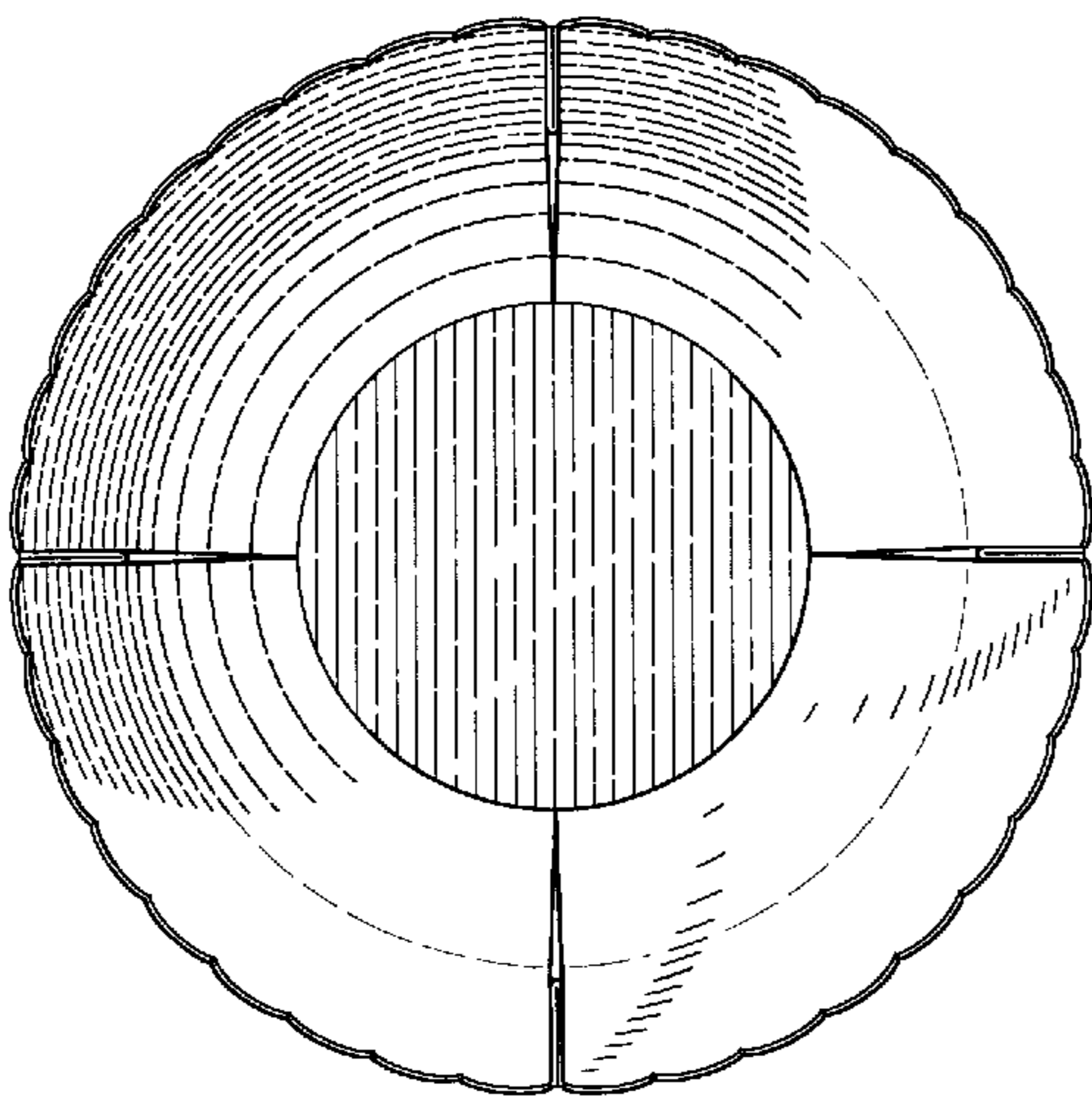

FIG. 7

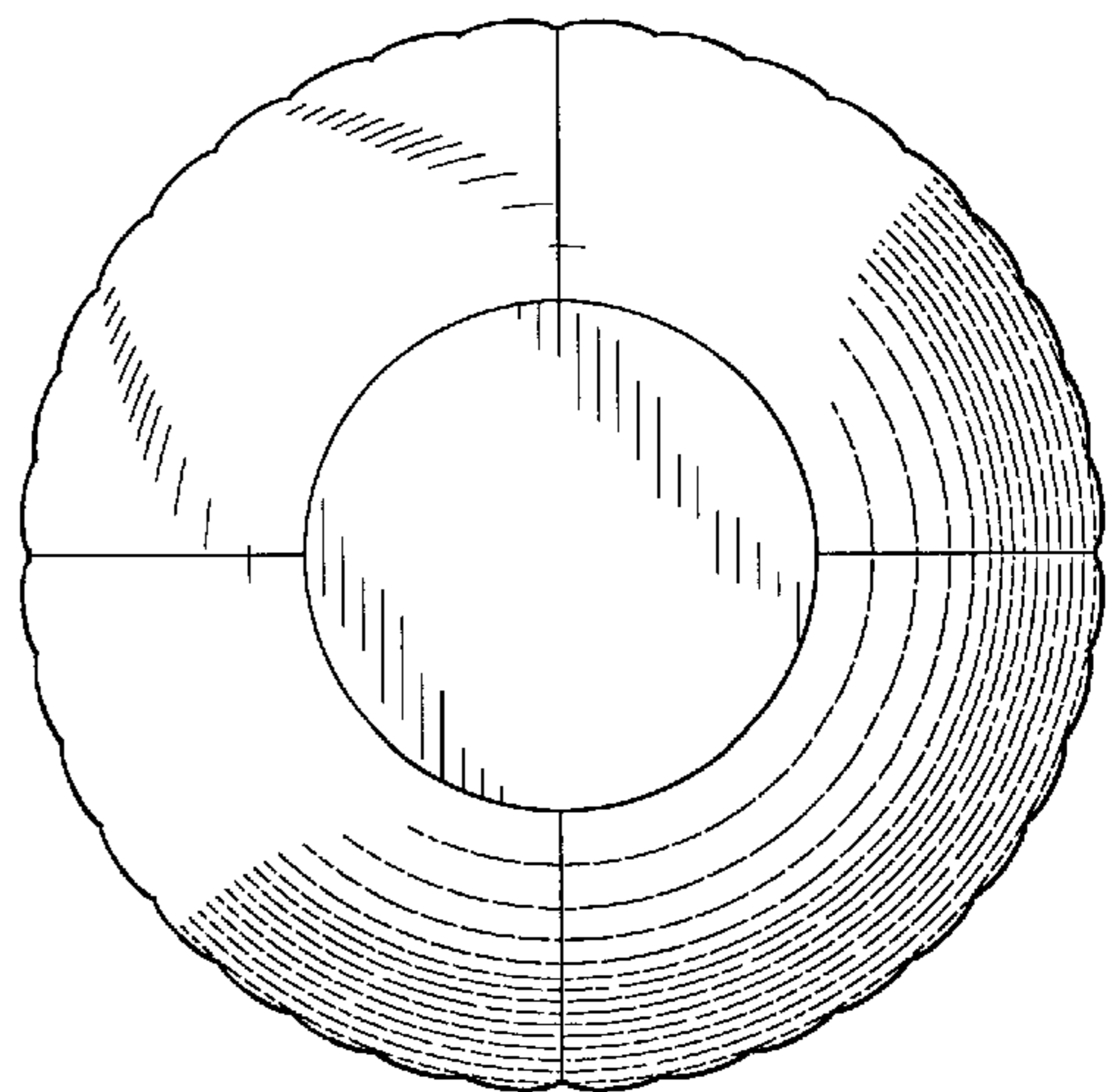

FIG. 8

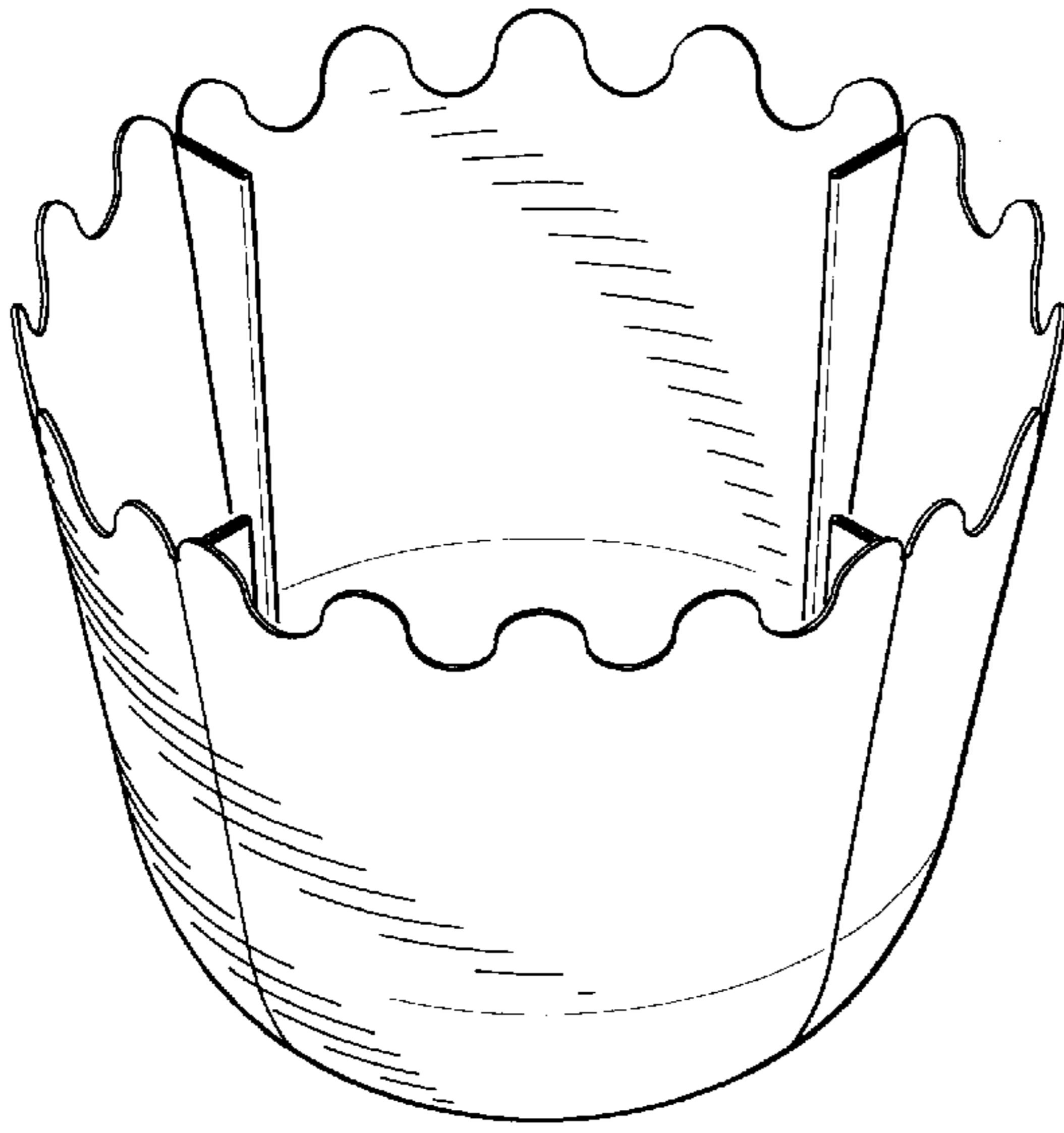

FIG. 9

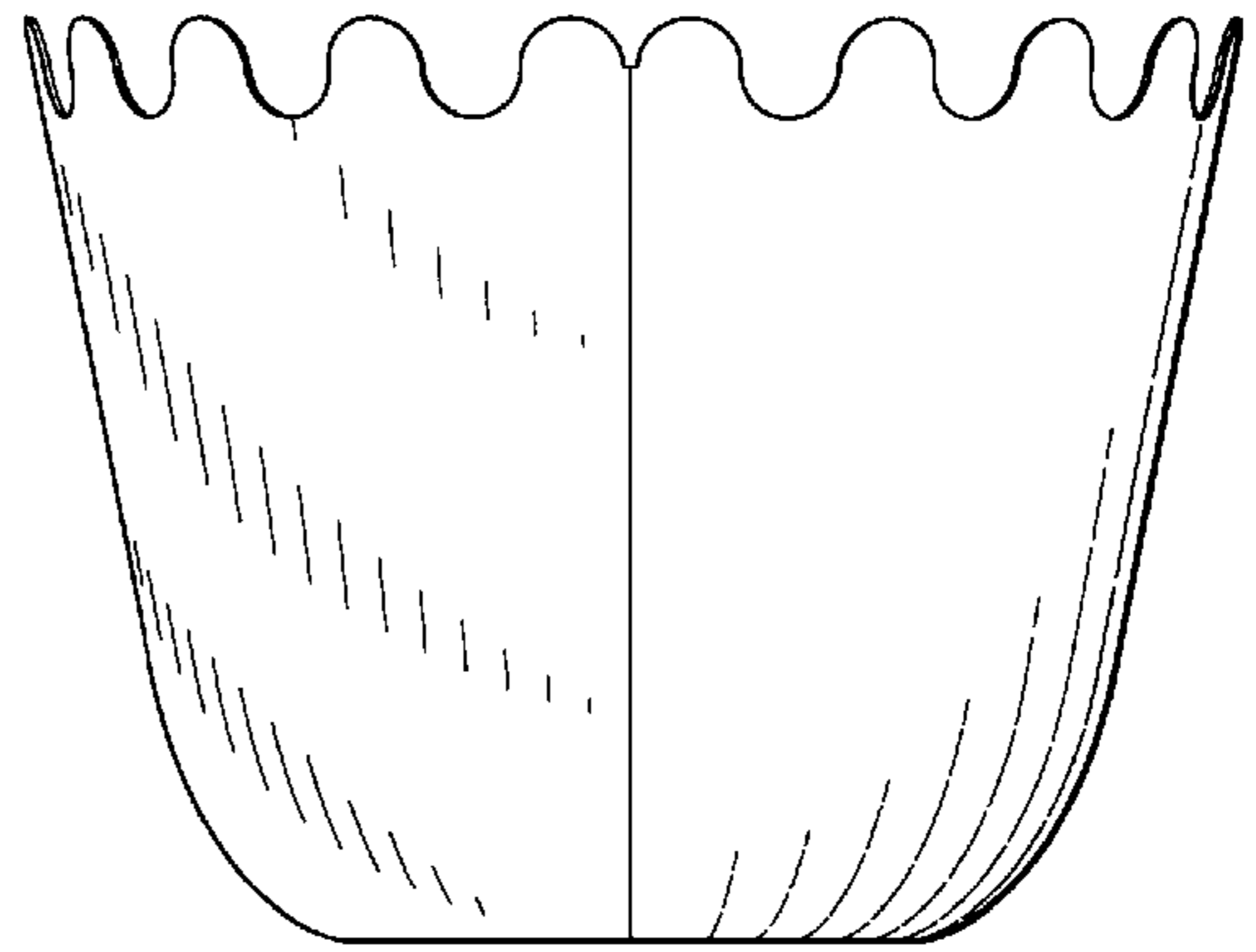

FIG. 10

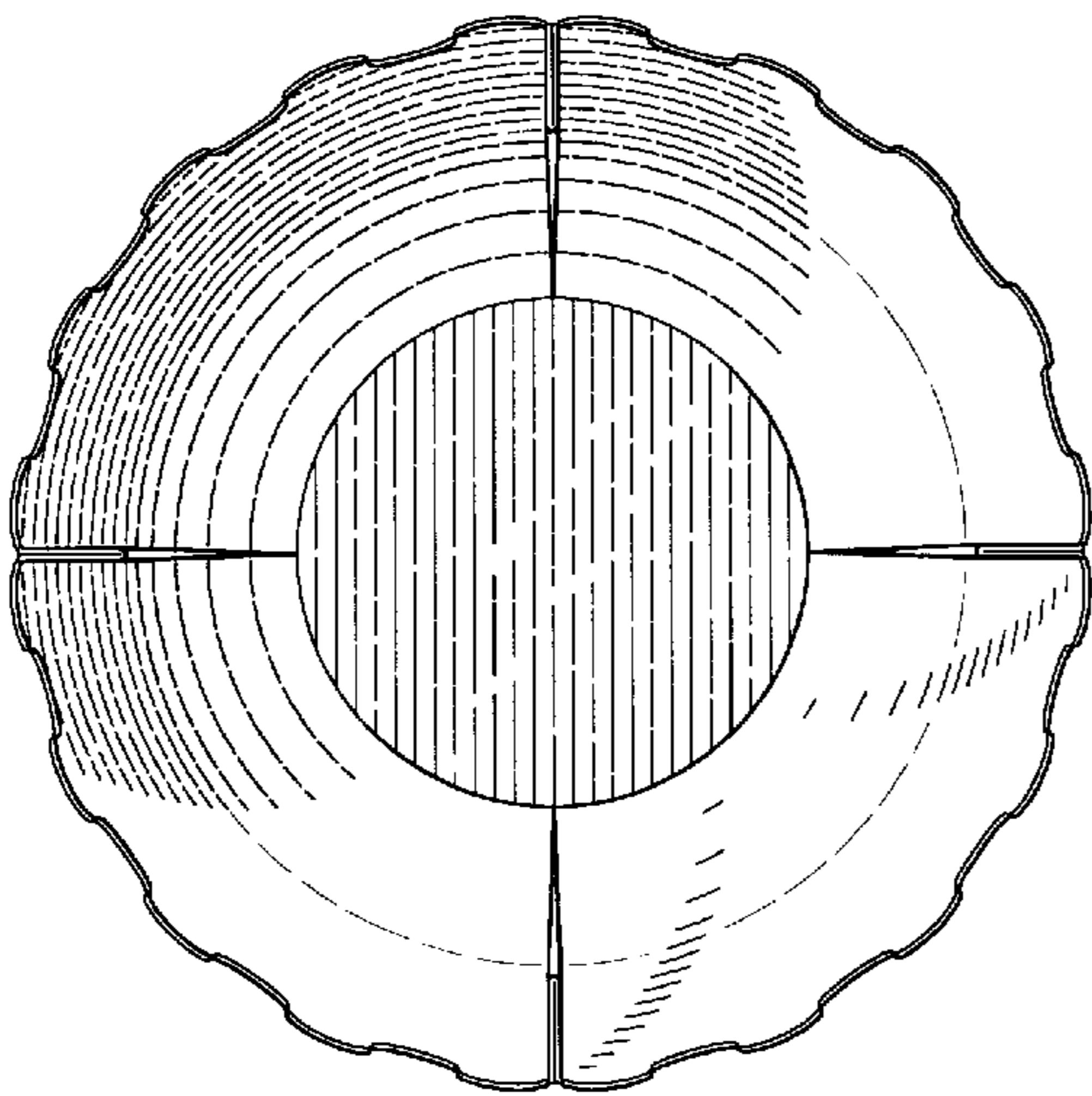

FIG. 11

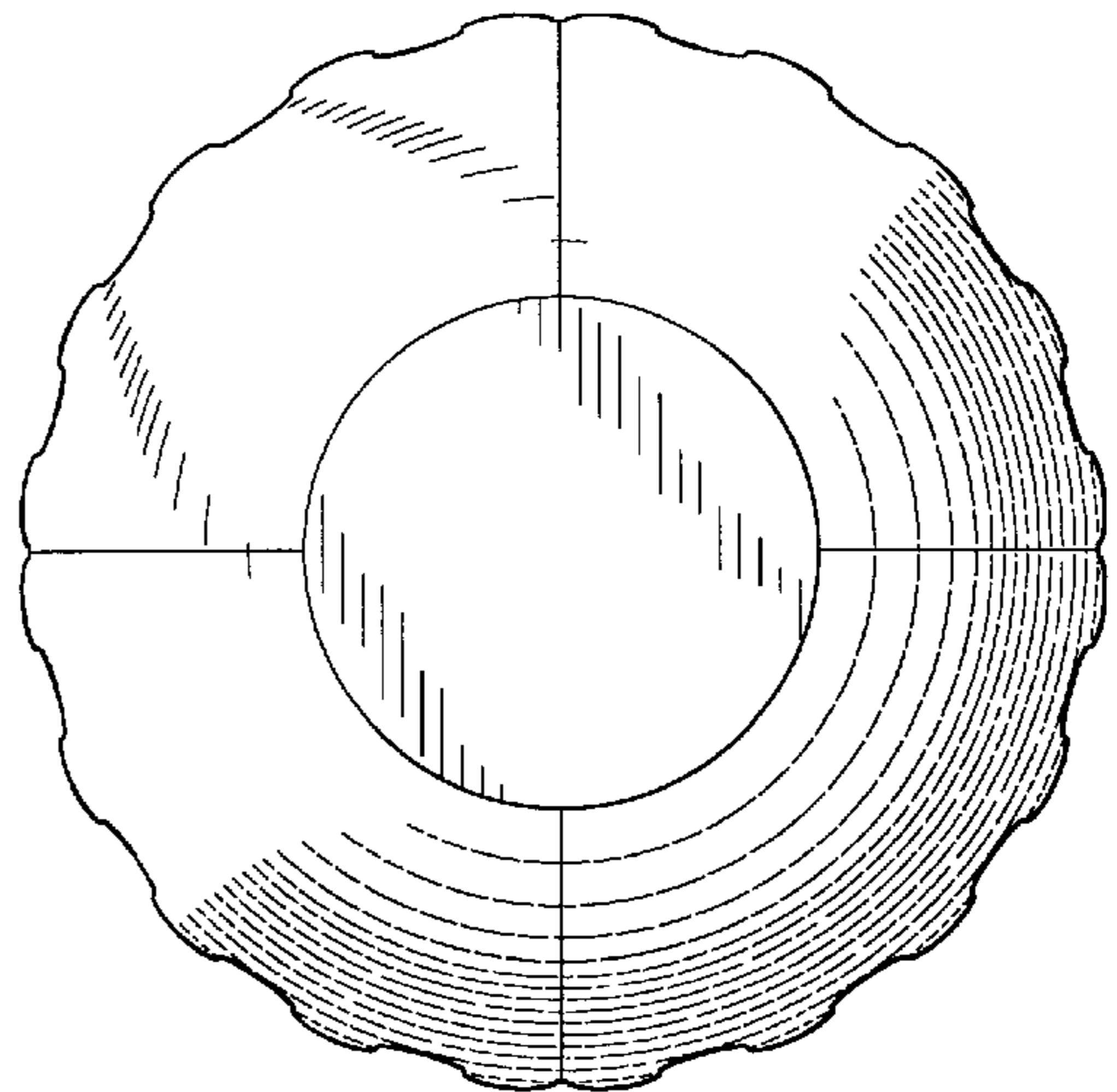

FIG. 12

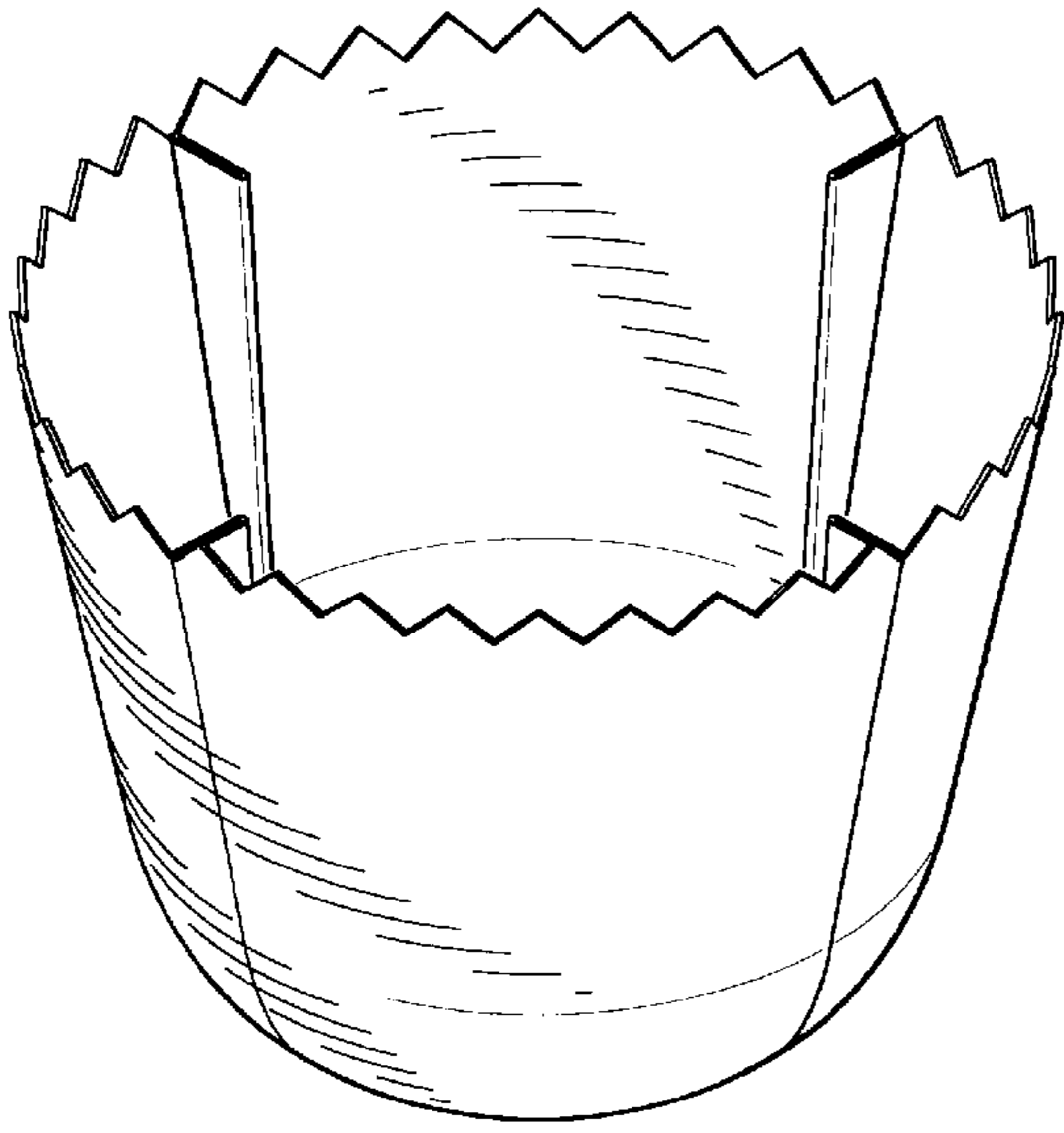

FIG. 13

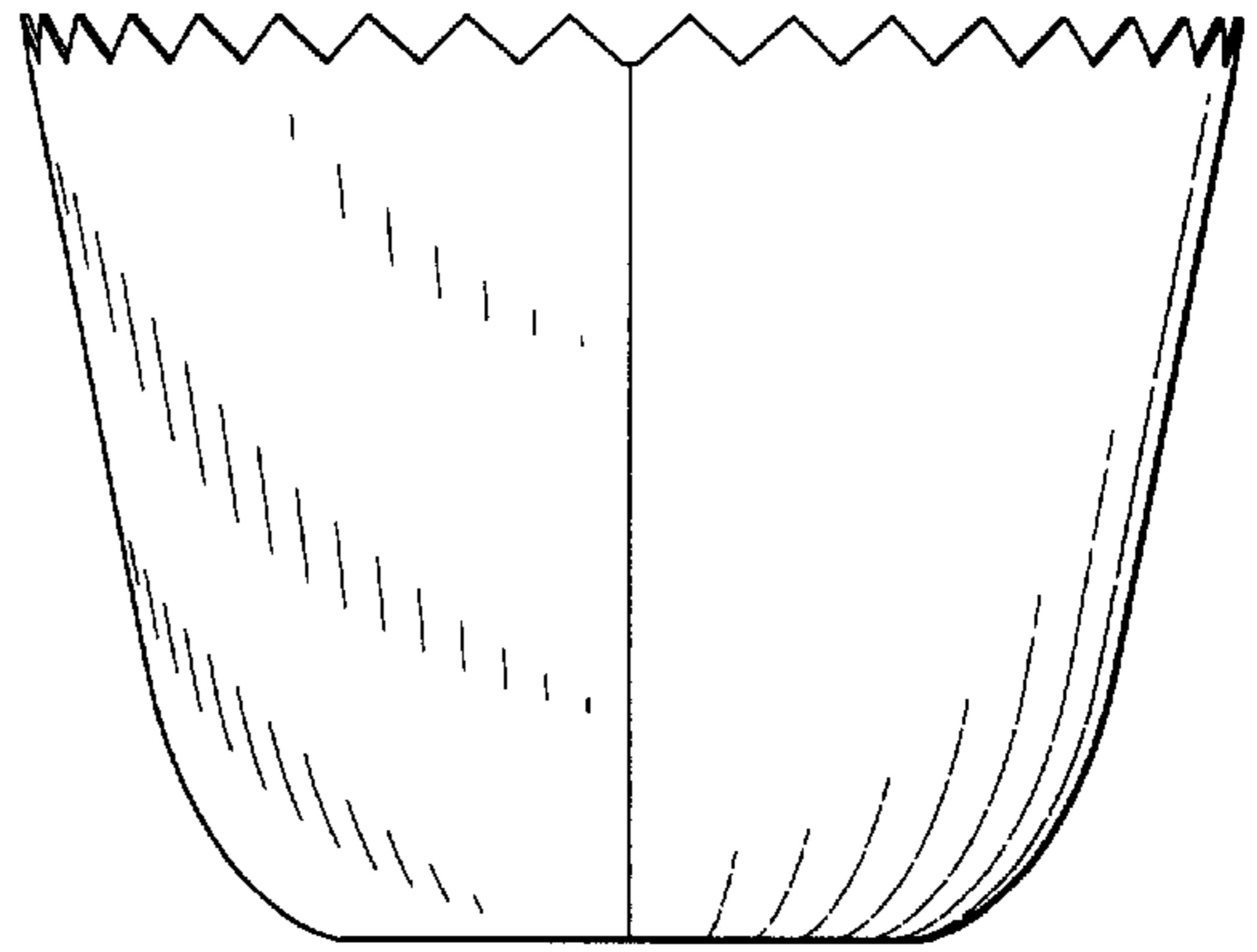

FIG. 14

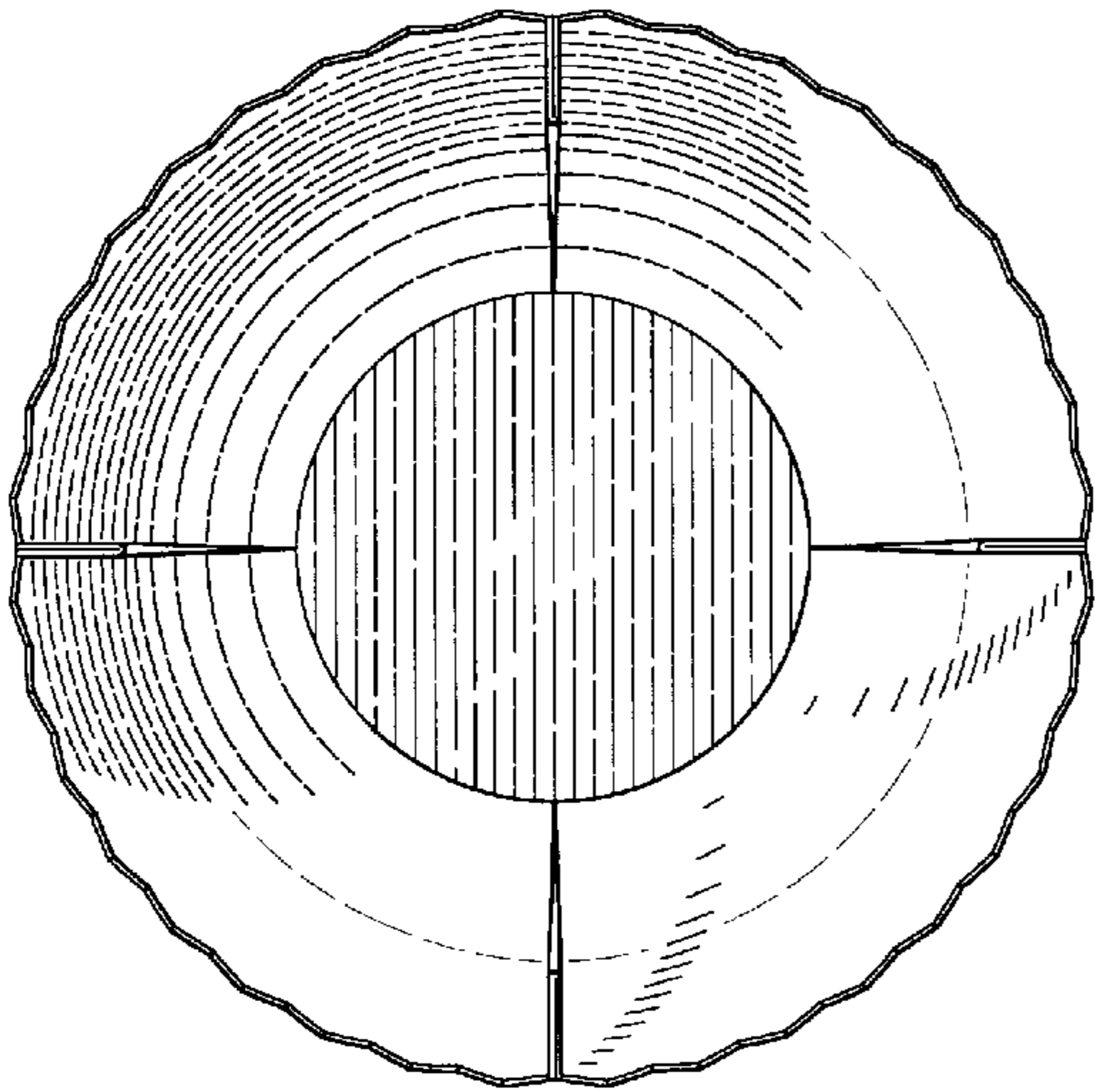

FIG. 15

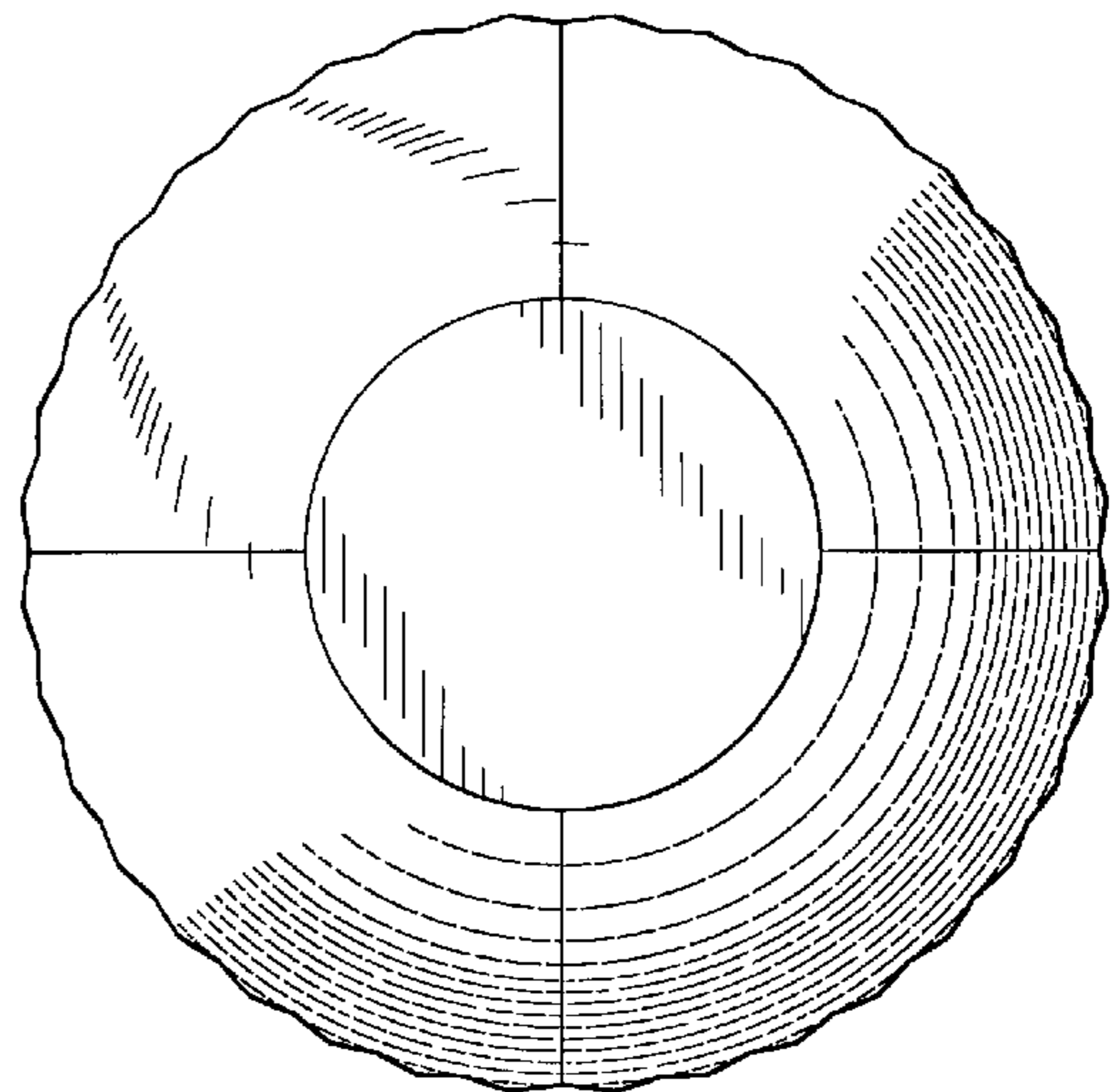

FIG. 16

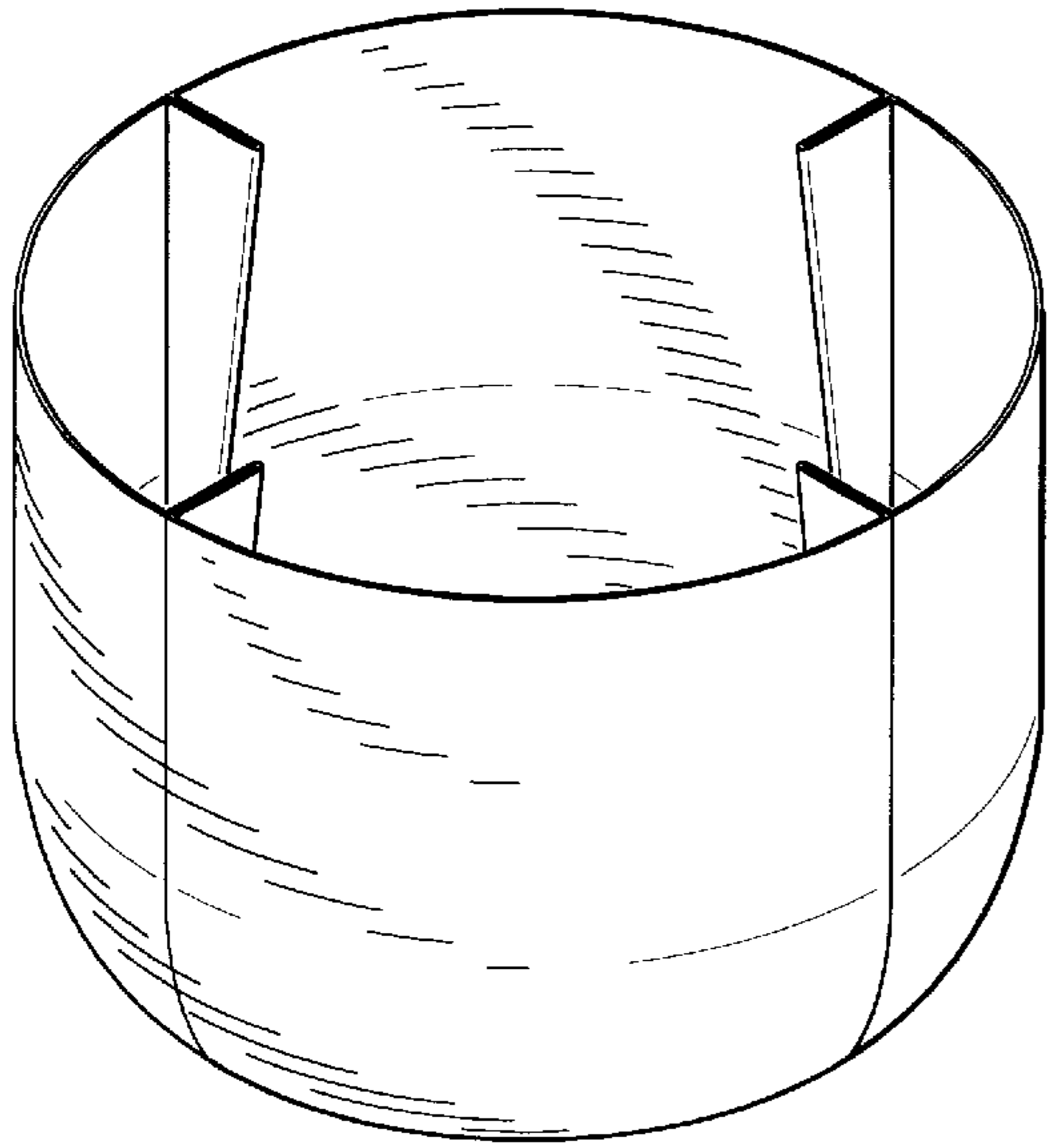

FIG. 17

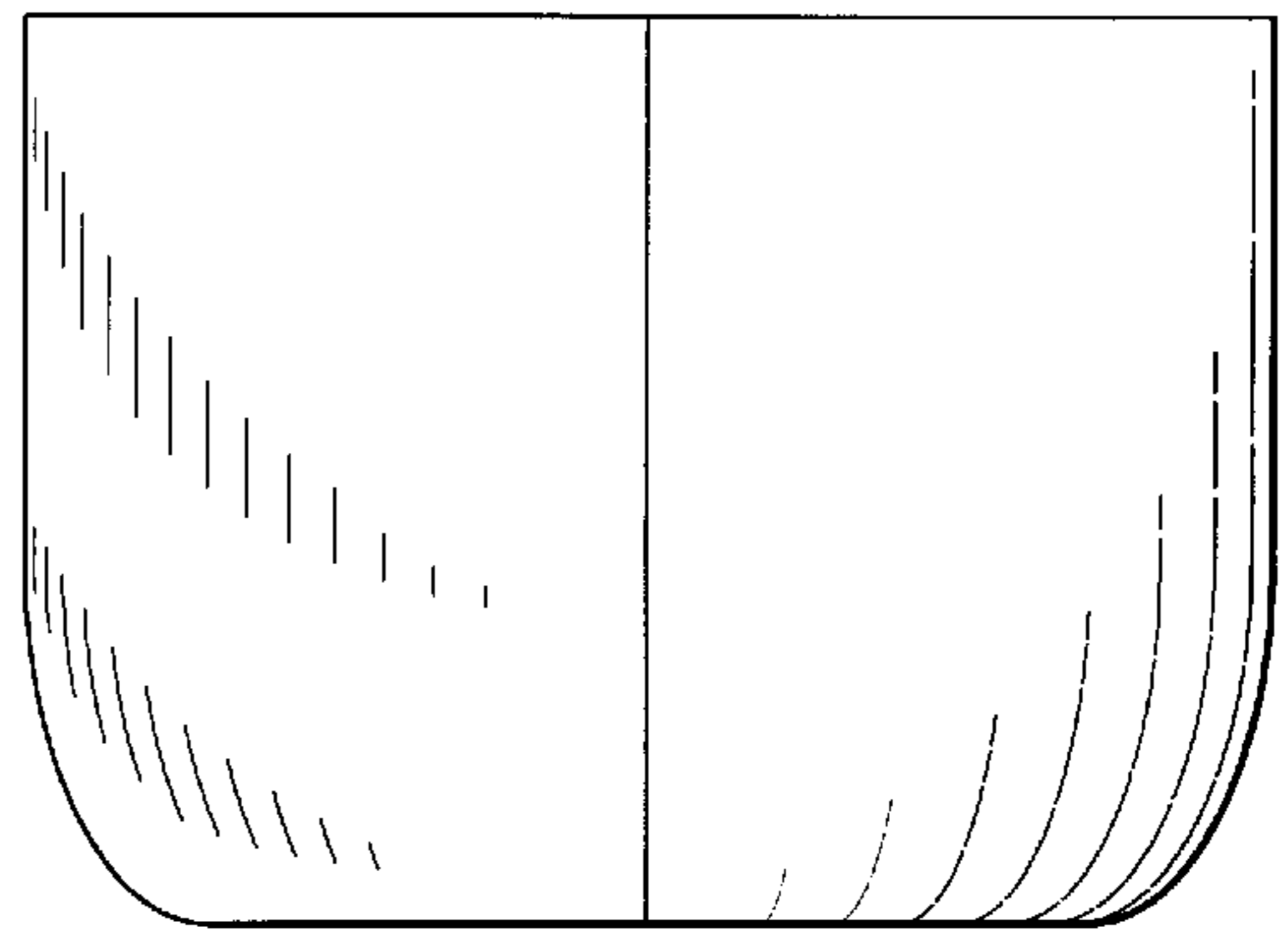

FIG. 18

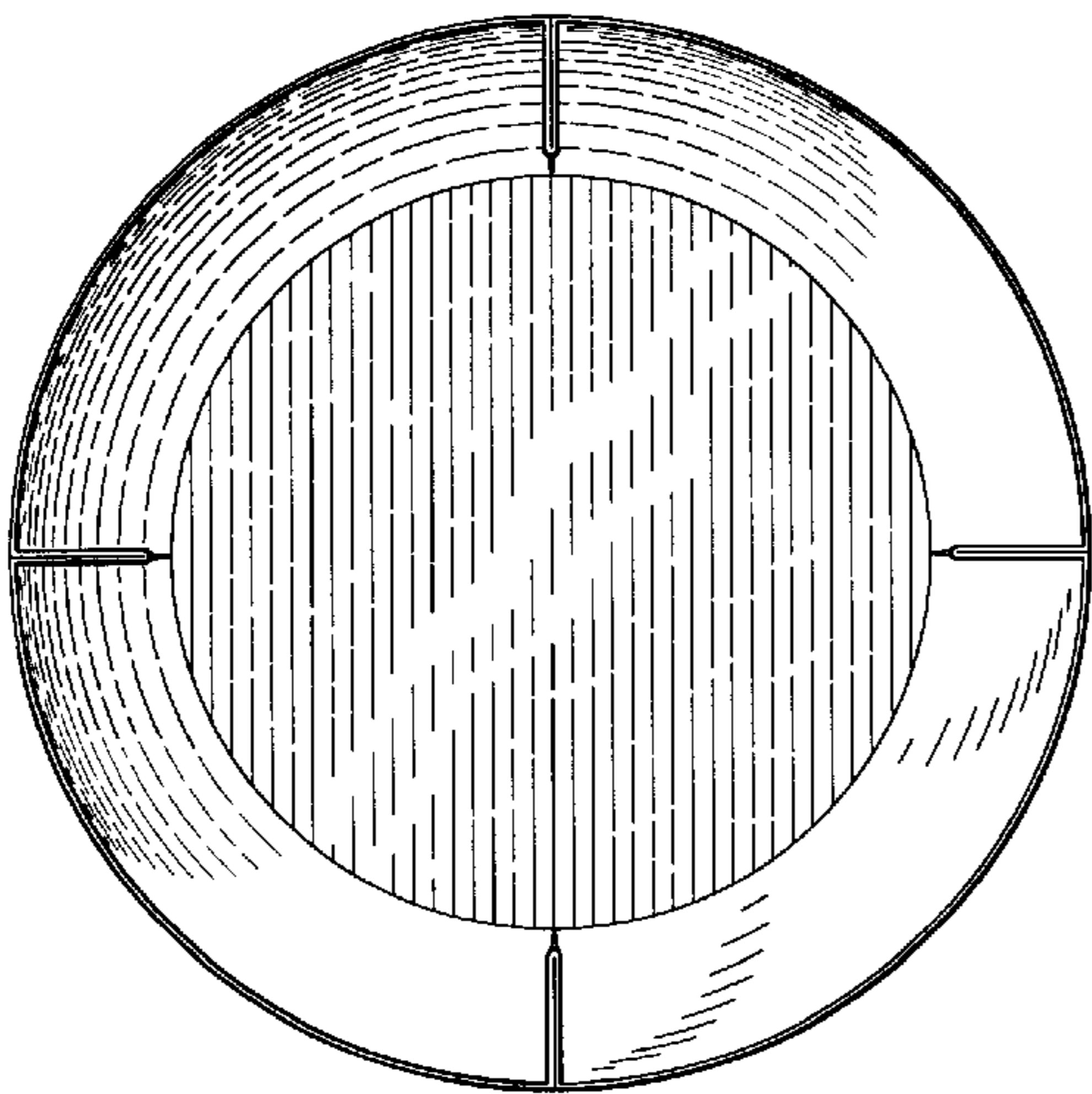

FIG. 19

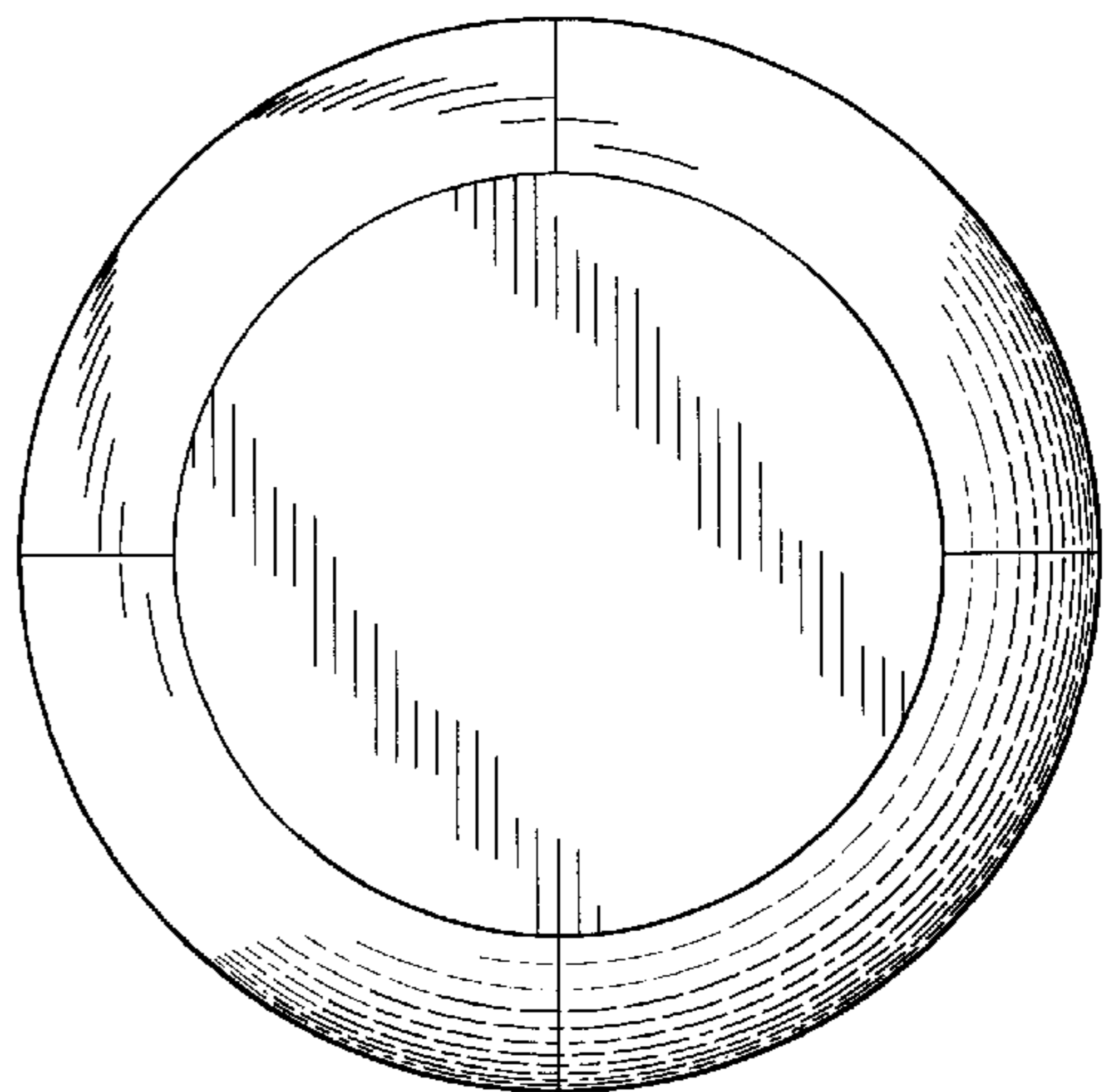

FIG. 20

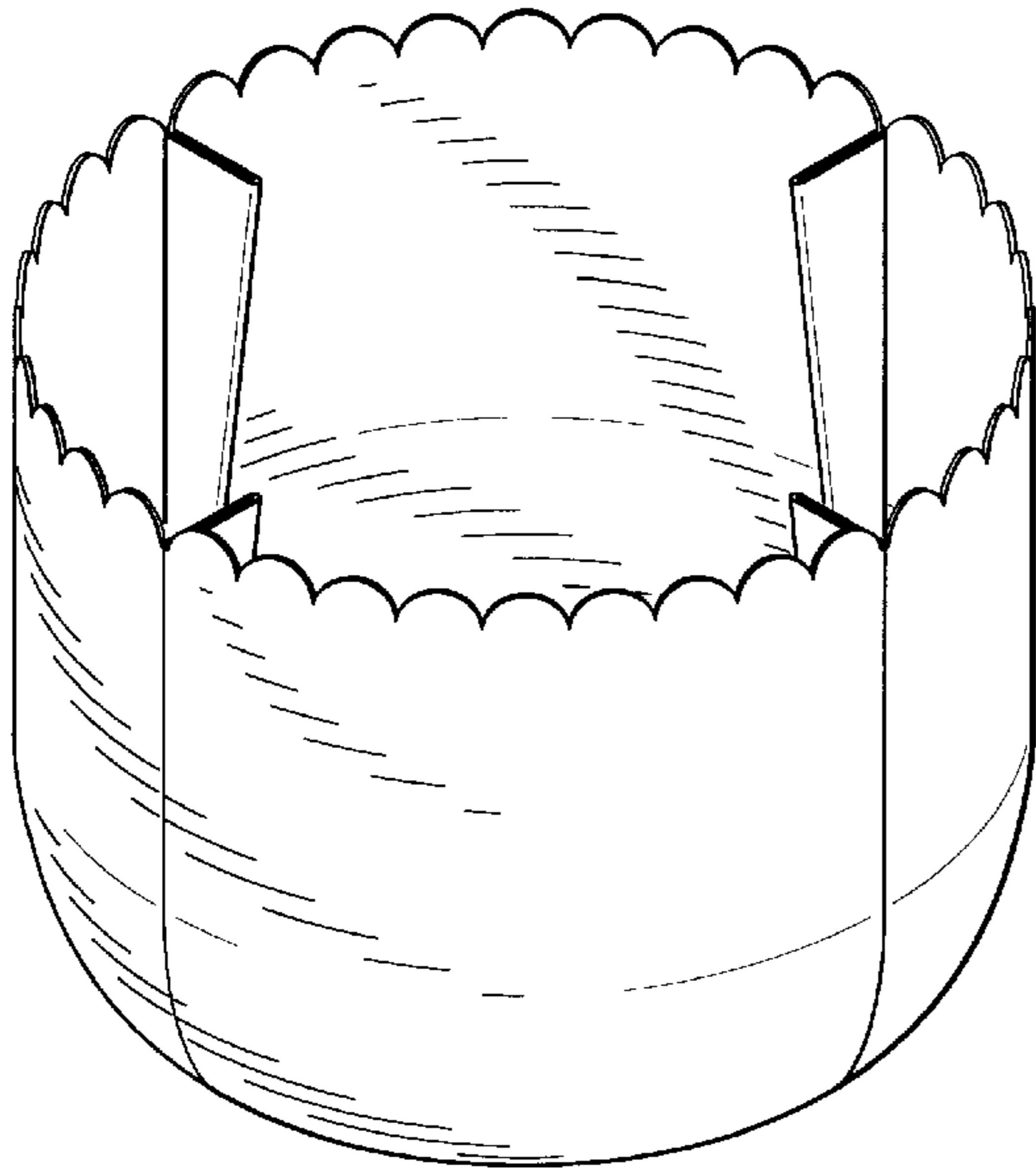

FIG. 21

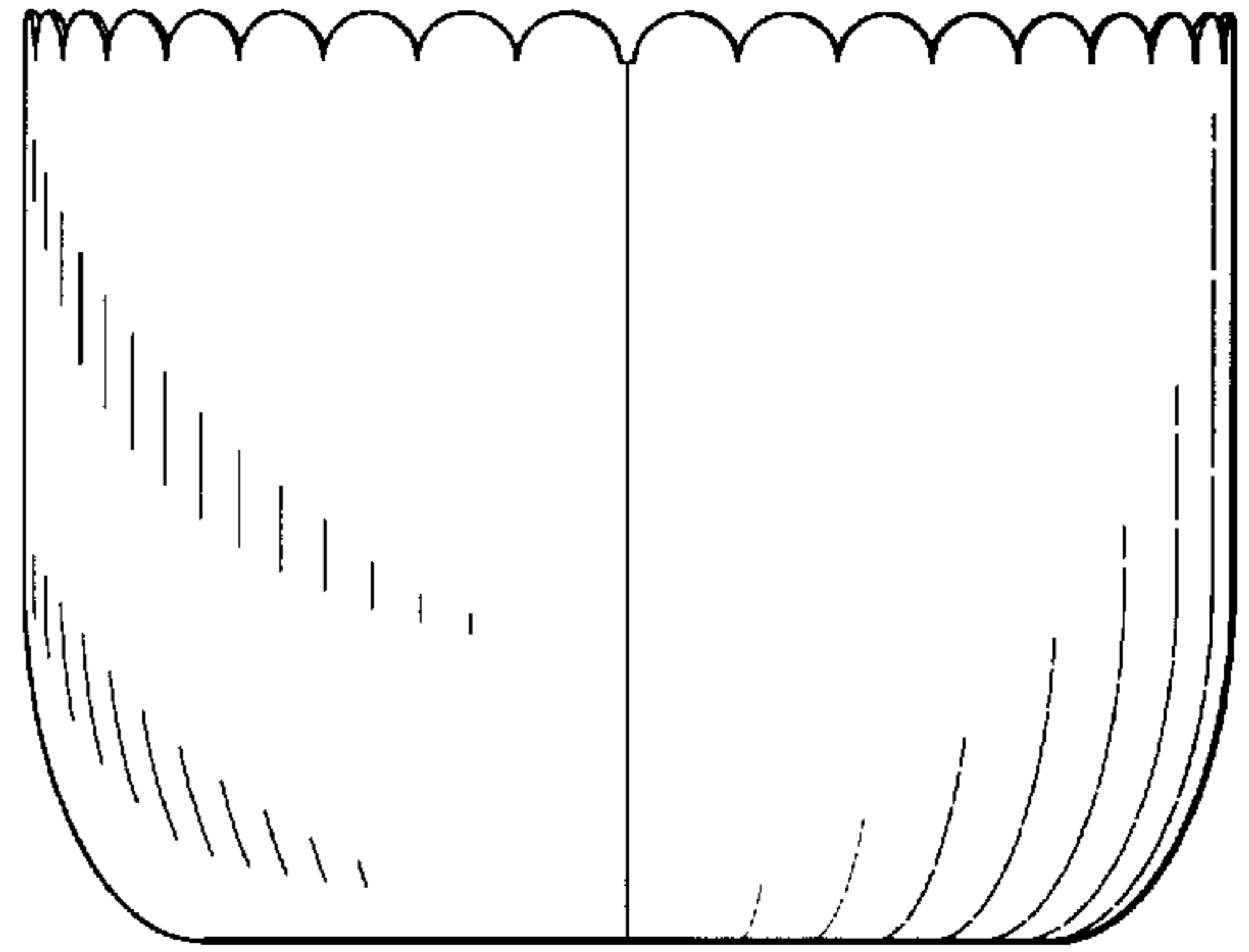

FIG. 22

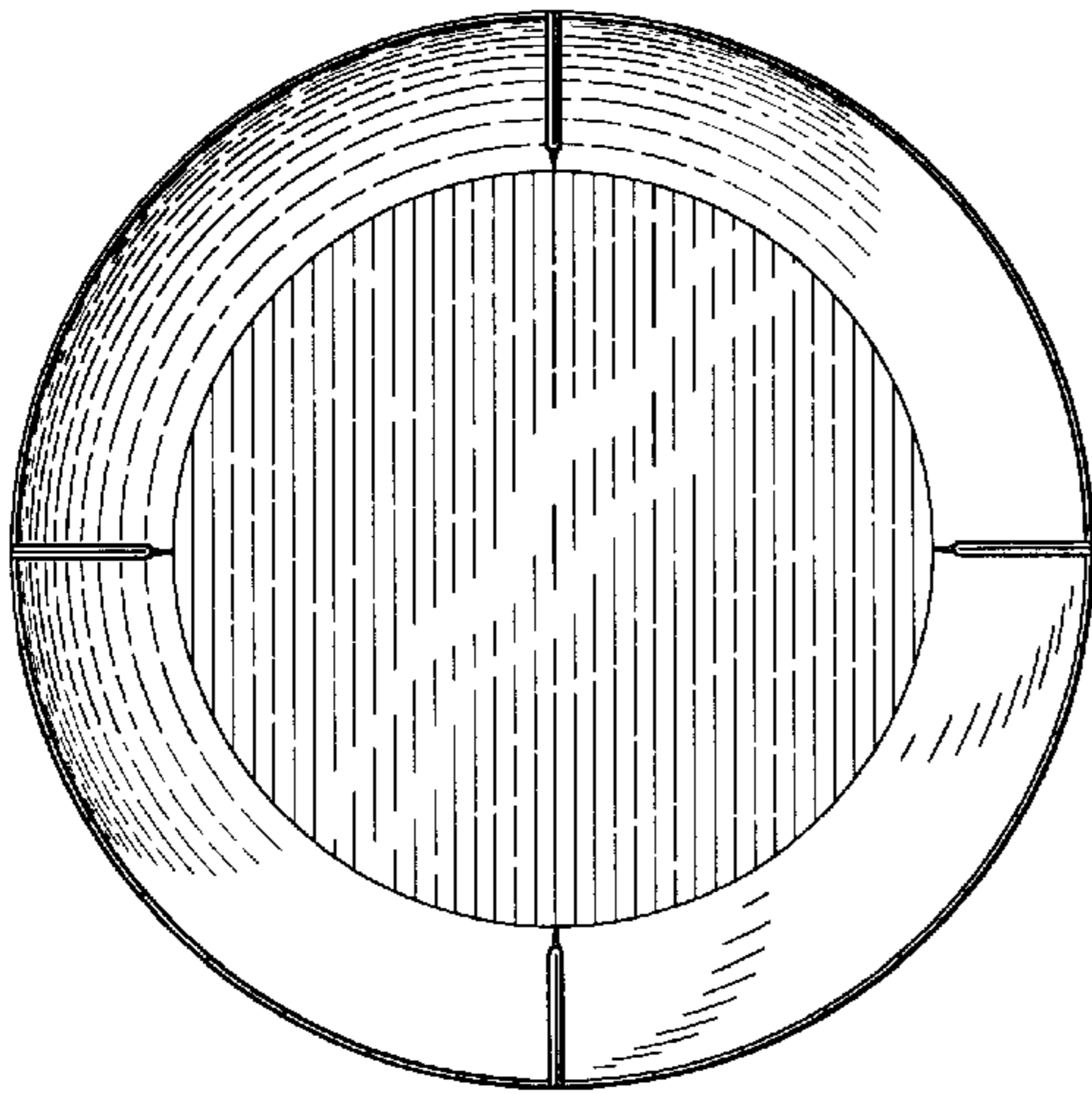

FIG. 23

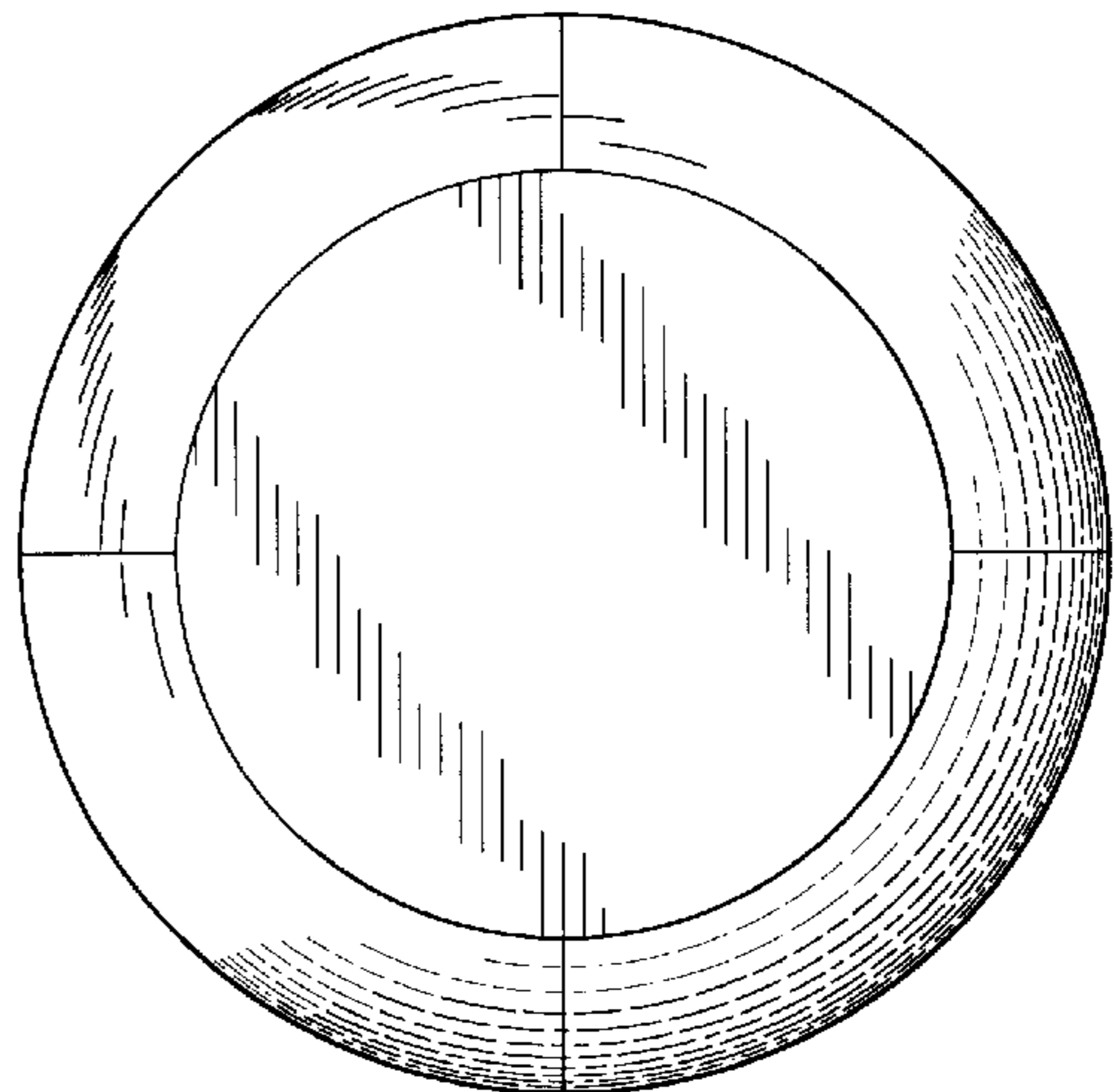

FIG. 24



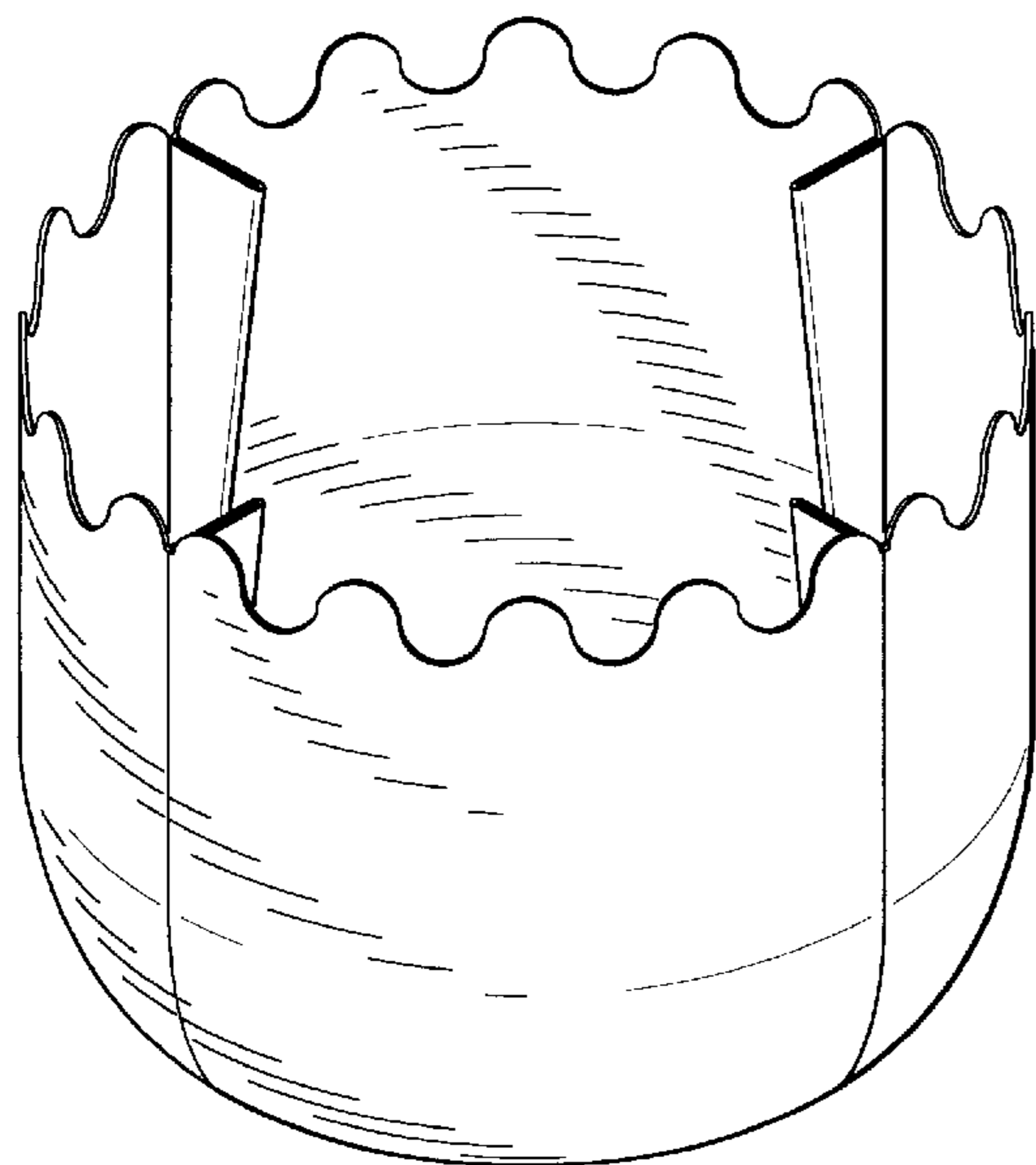

FIG. 25

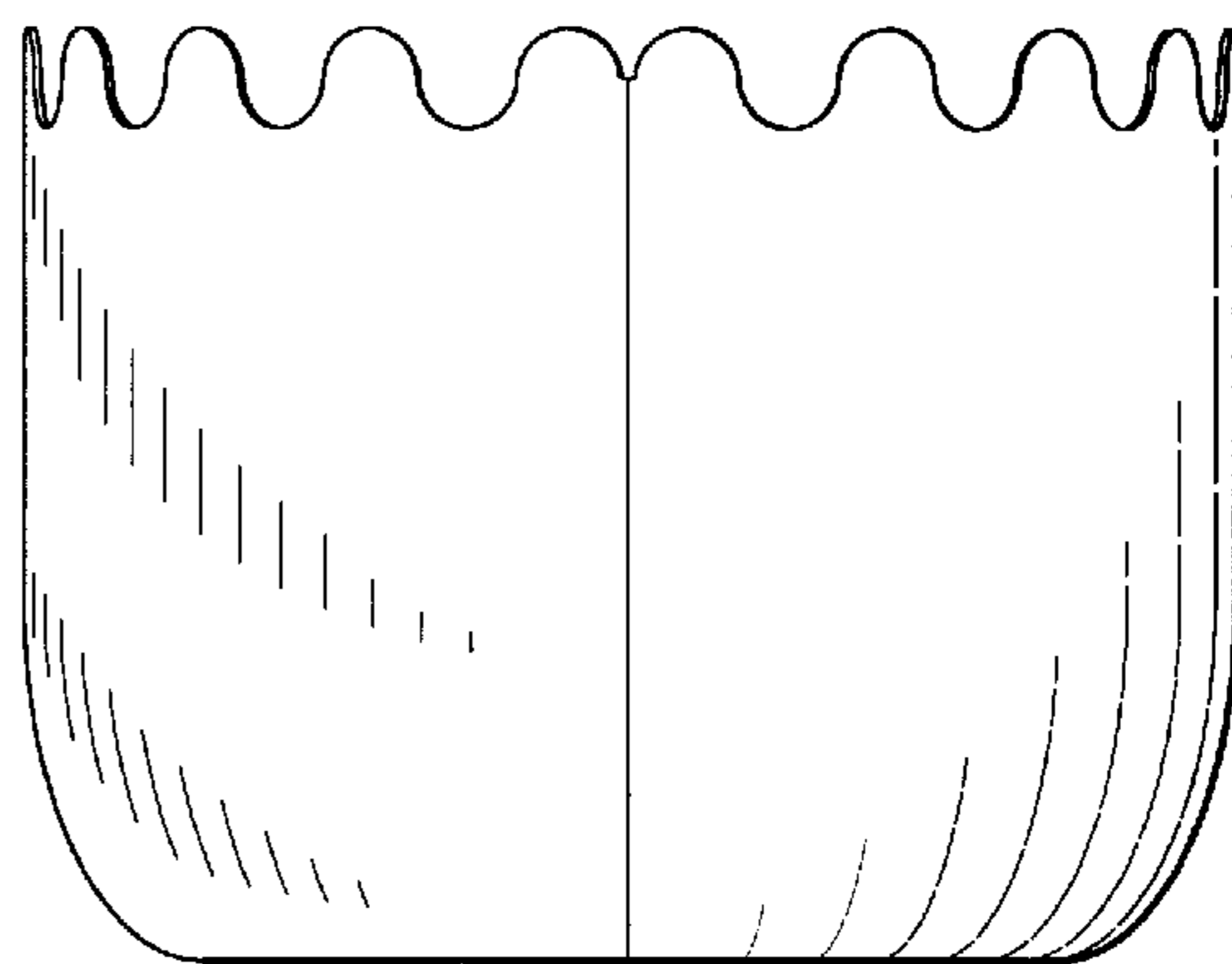

FIG. 26

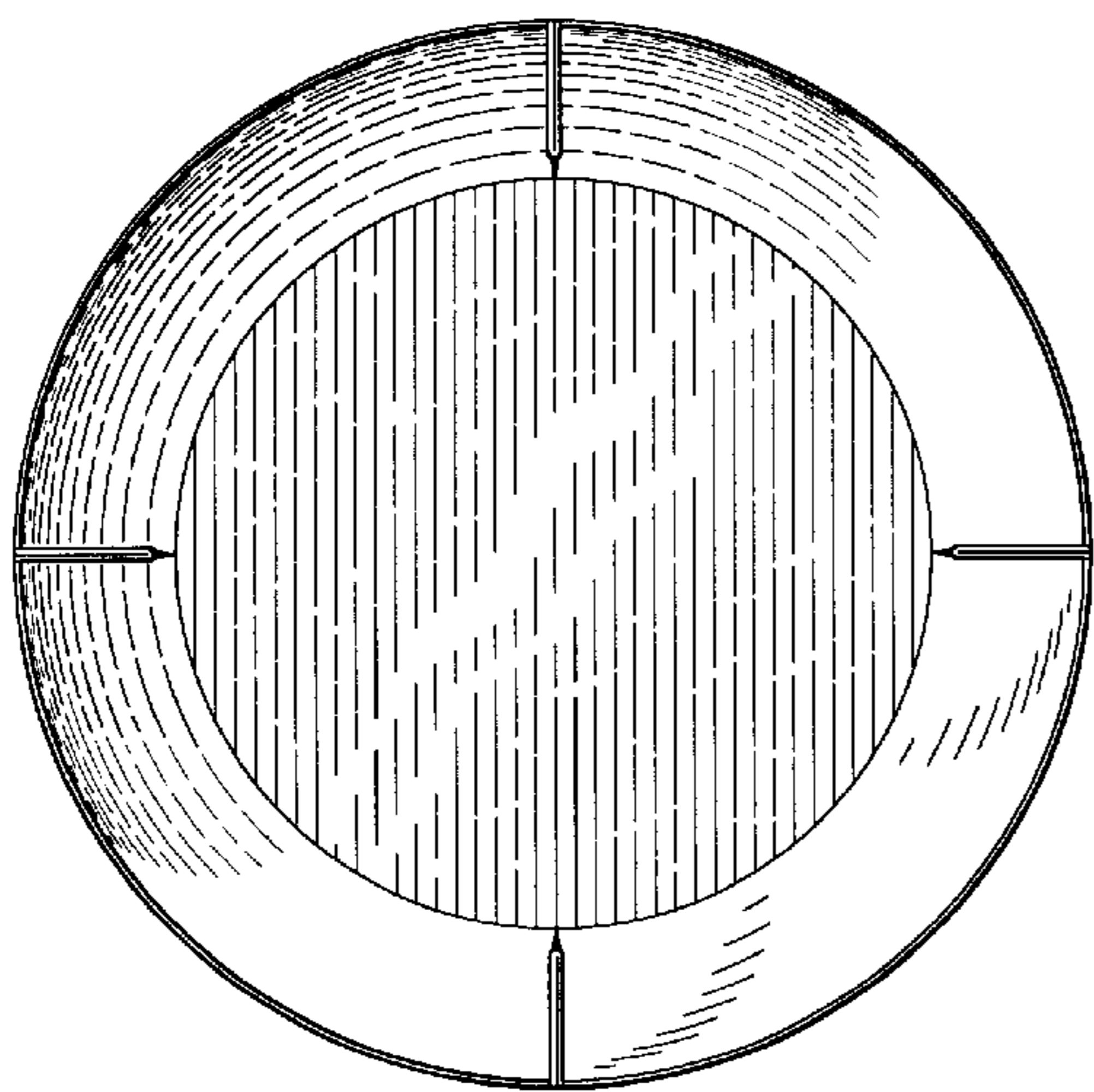

FIG. 27

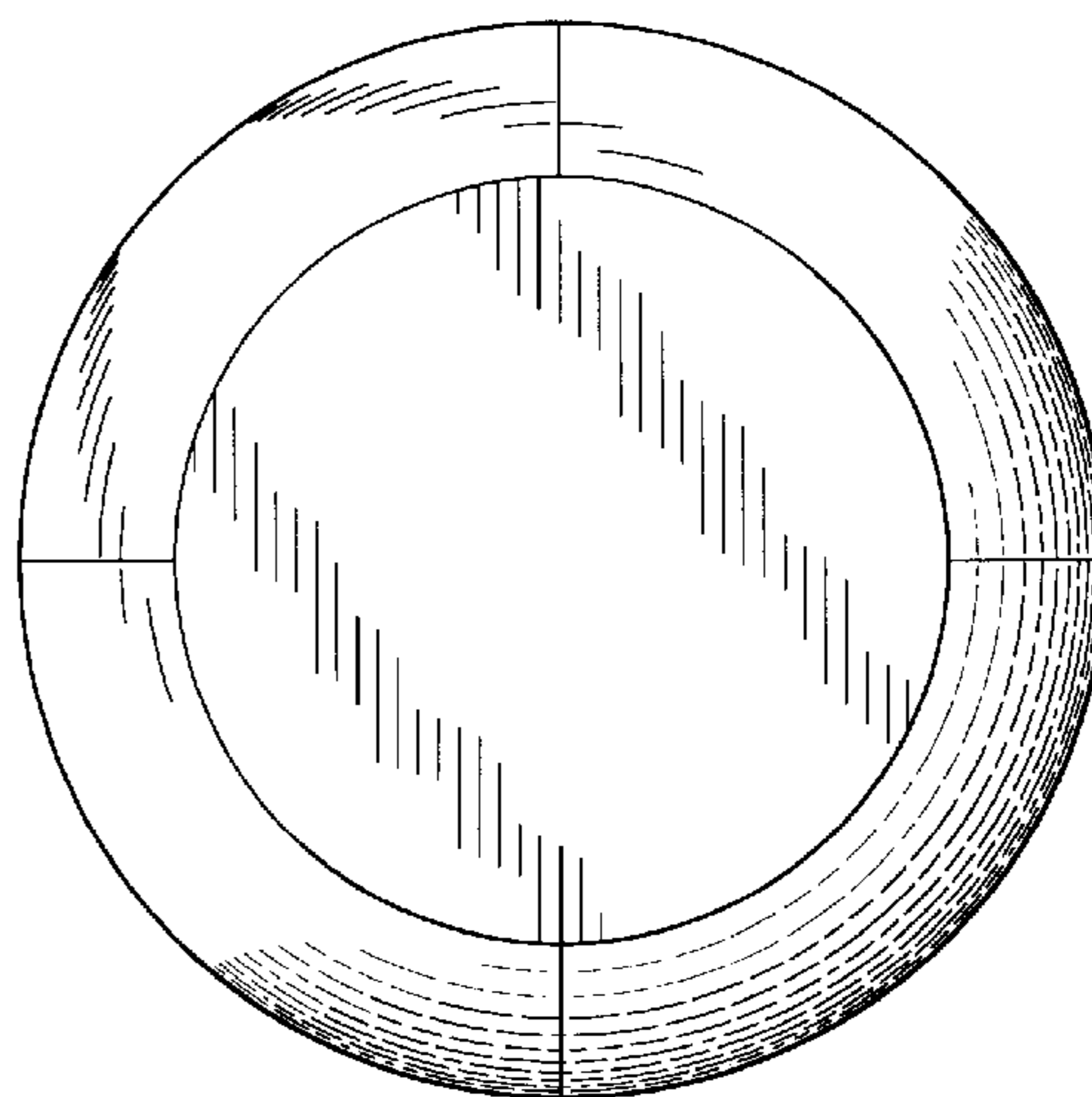

FIG. 28

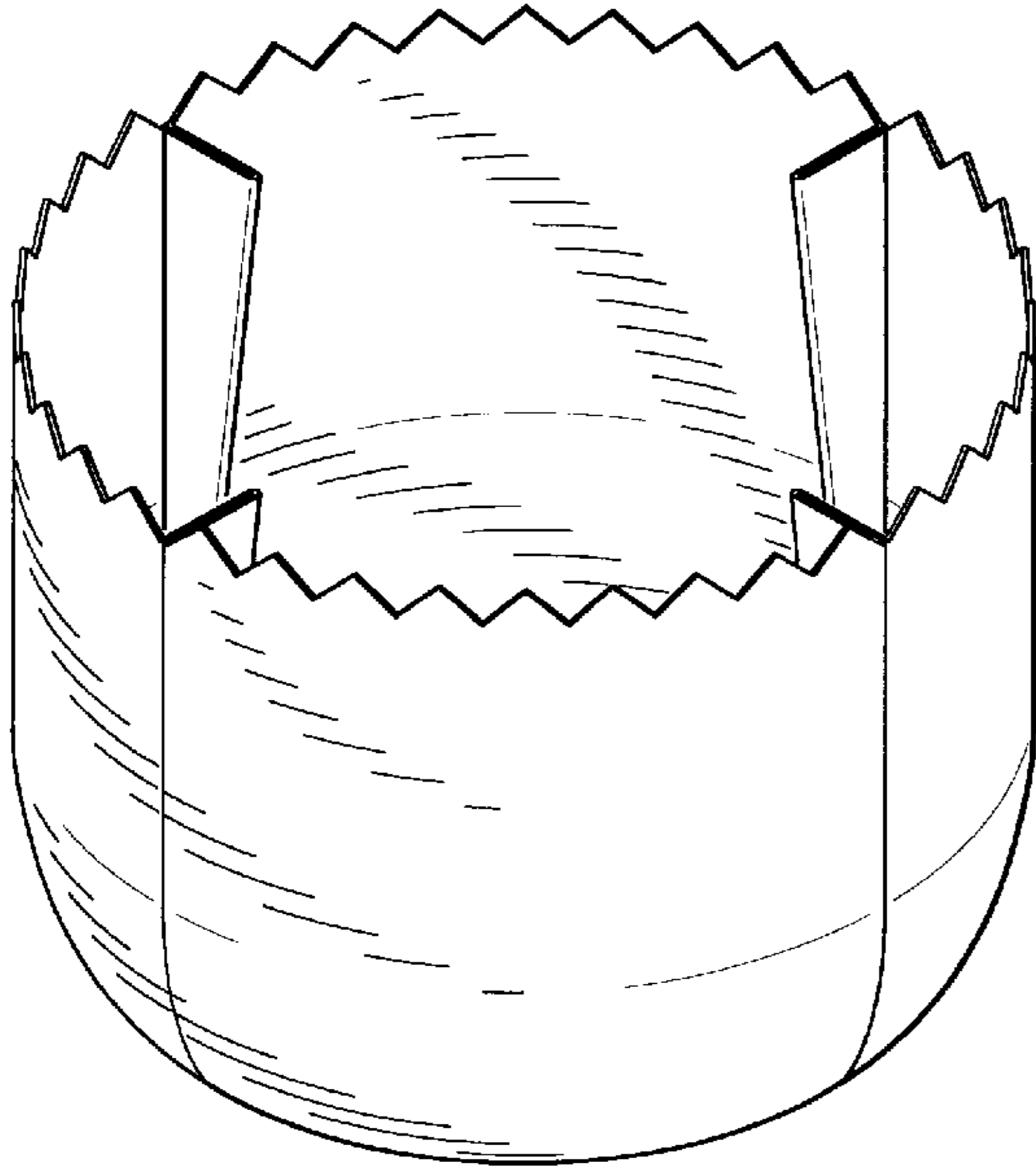

FIG. 29

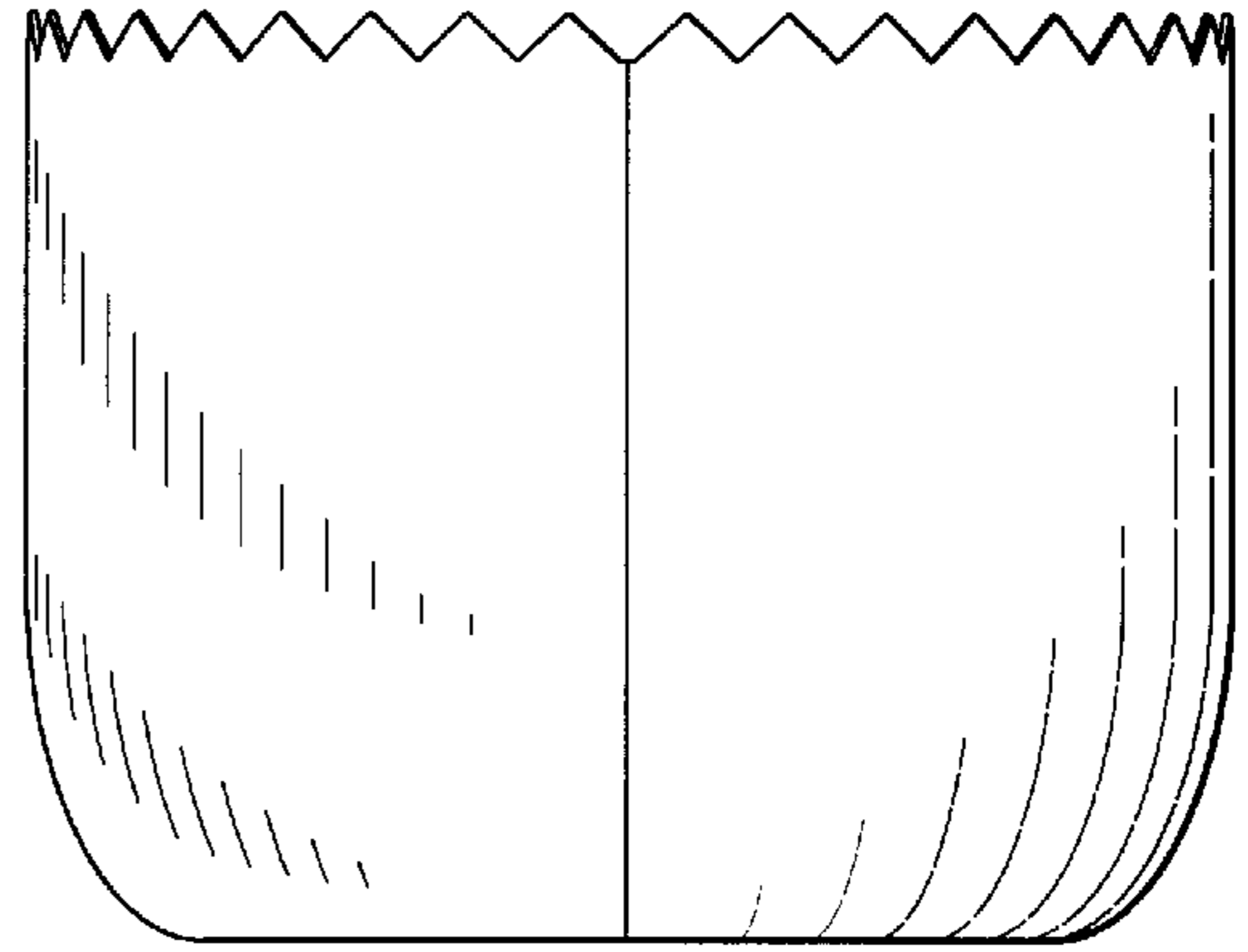

FIG. 30

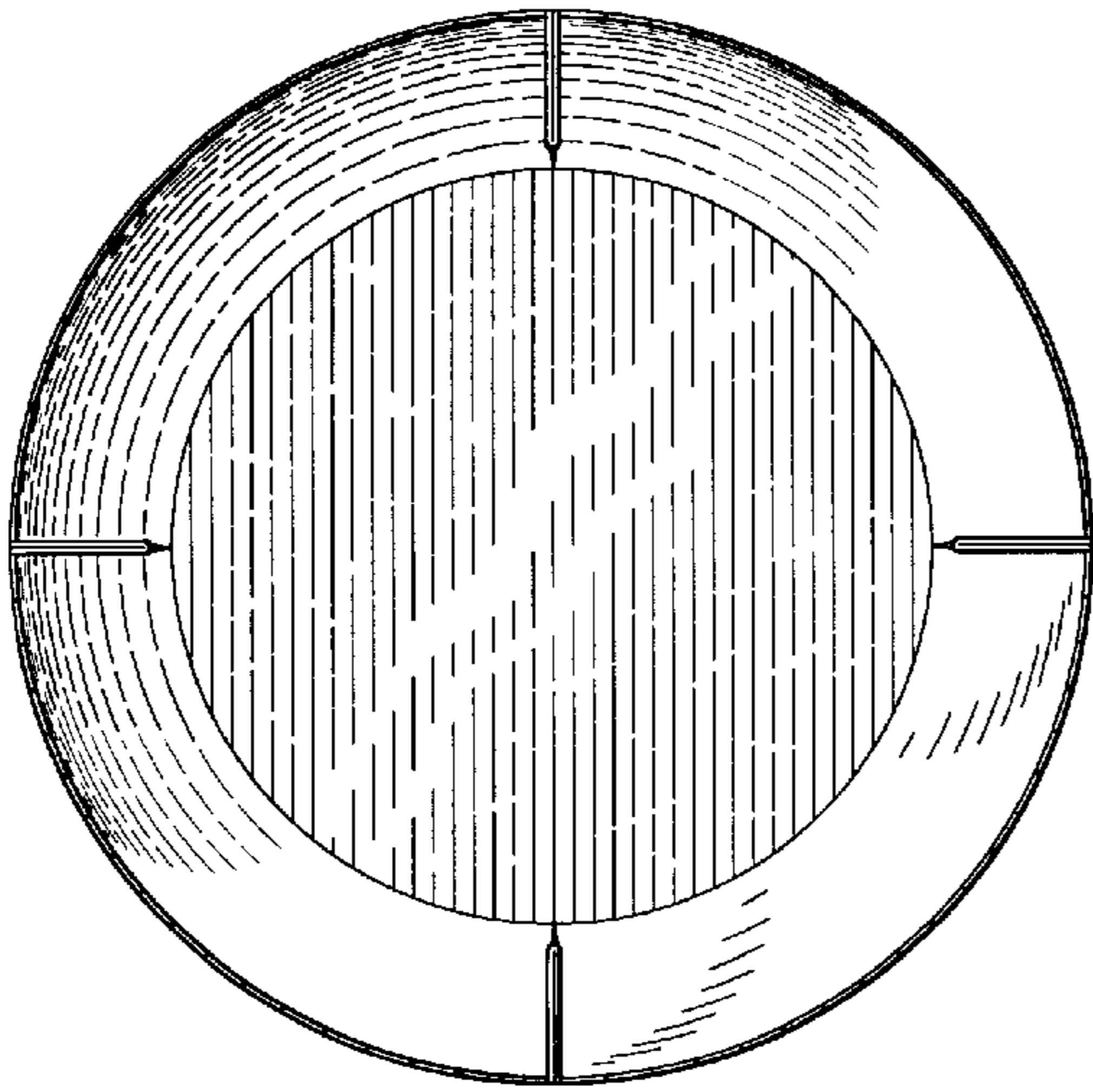

FIG. 31

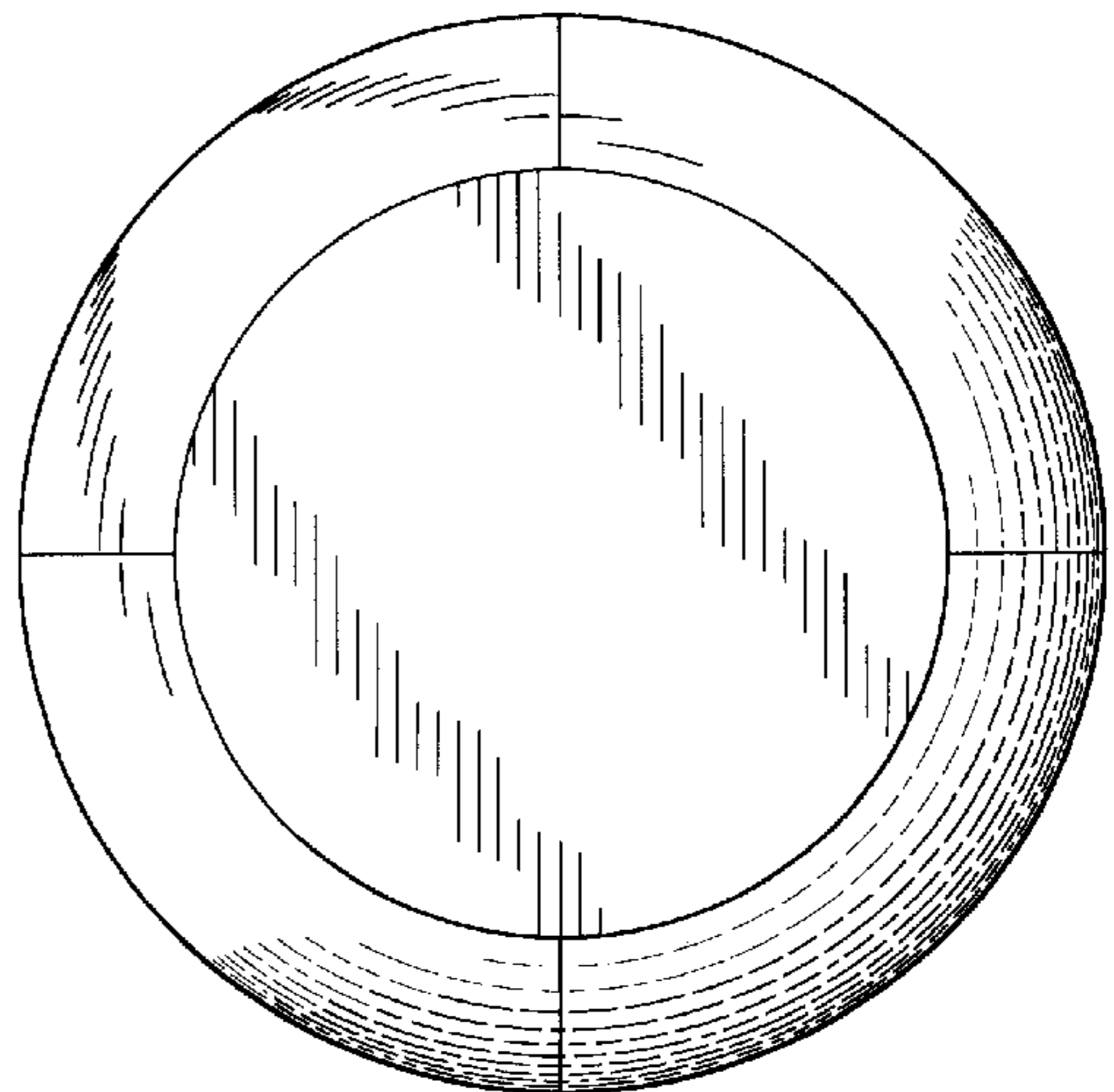

FIG. 32

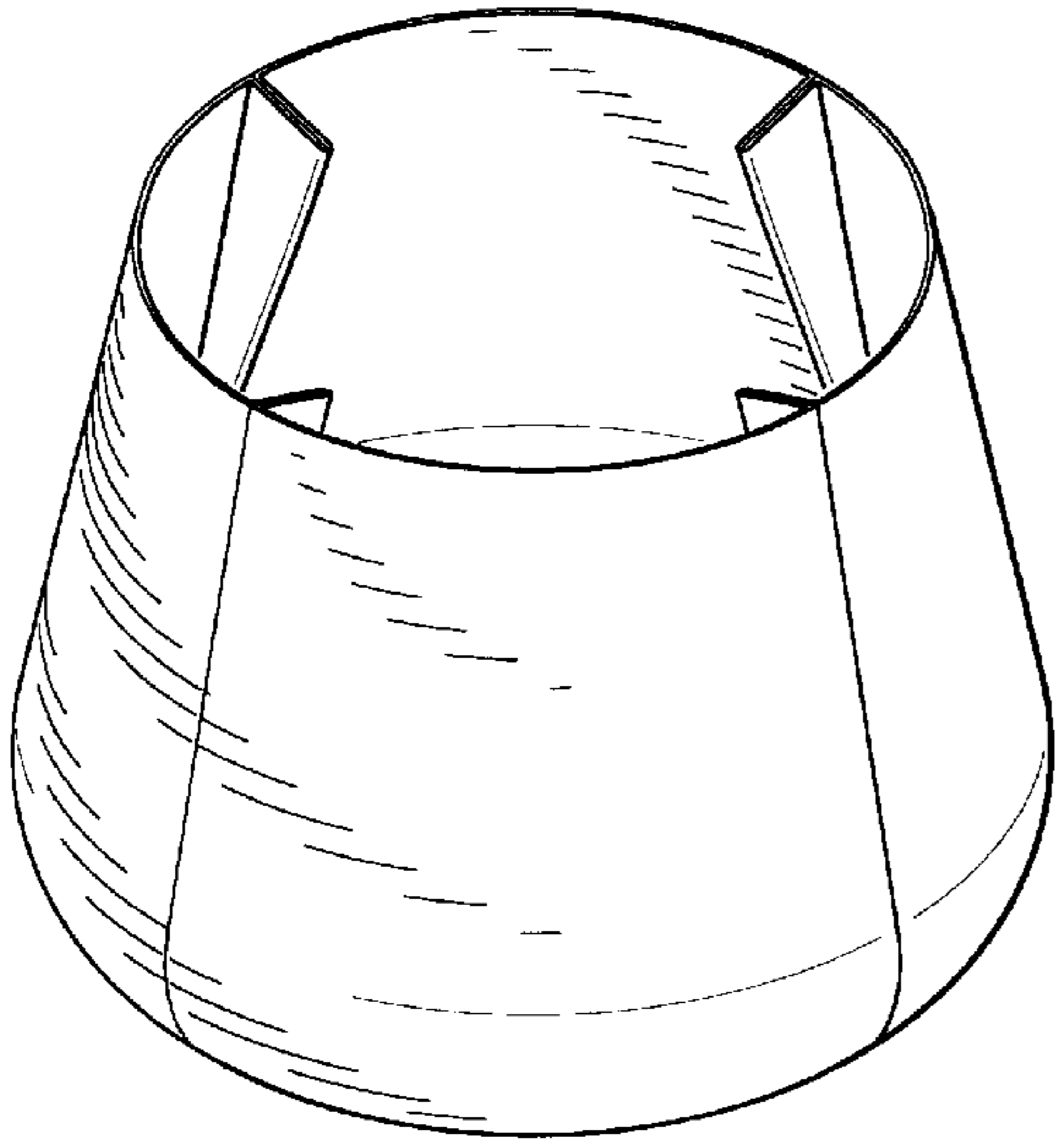

FIG. 33

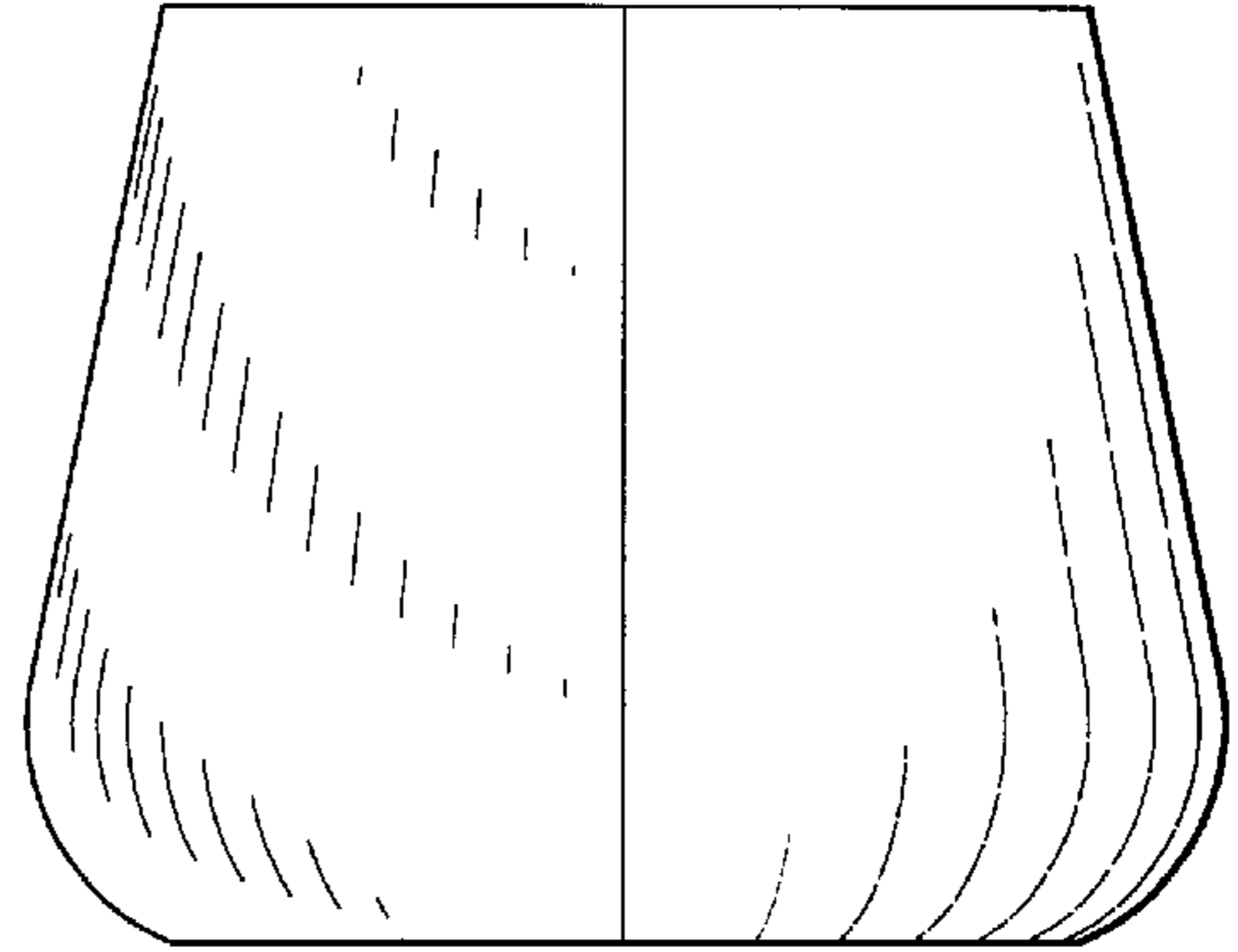

FIG. 34

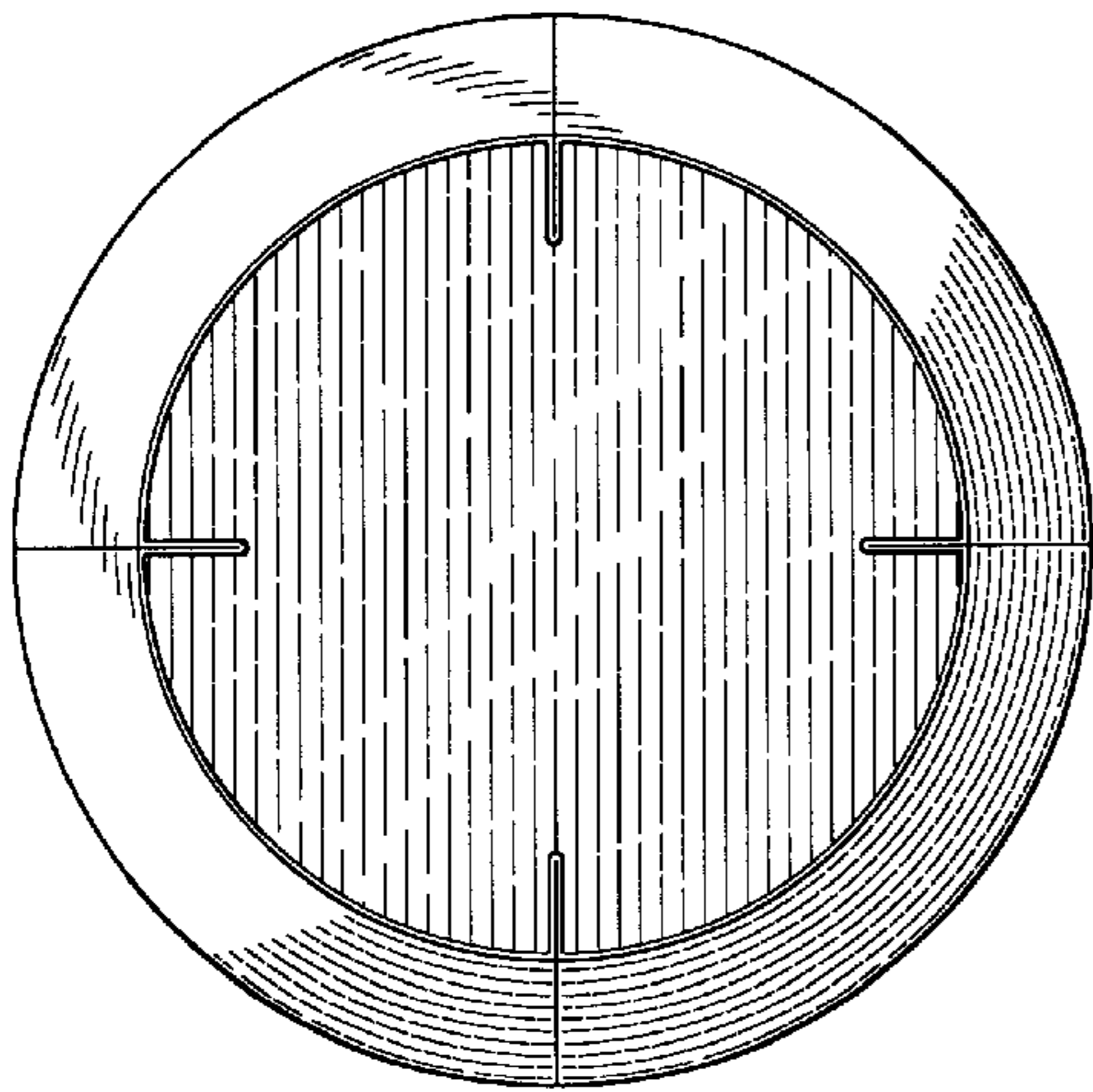

FIG. 35

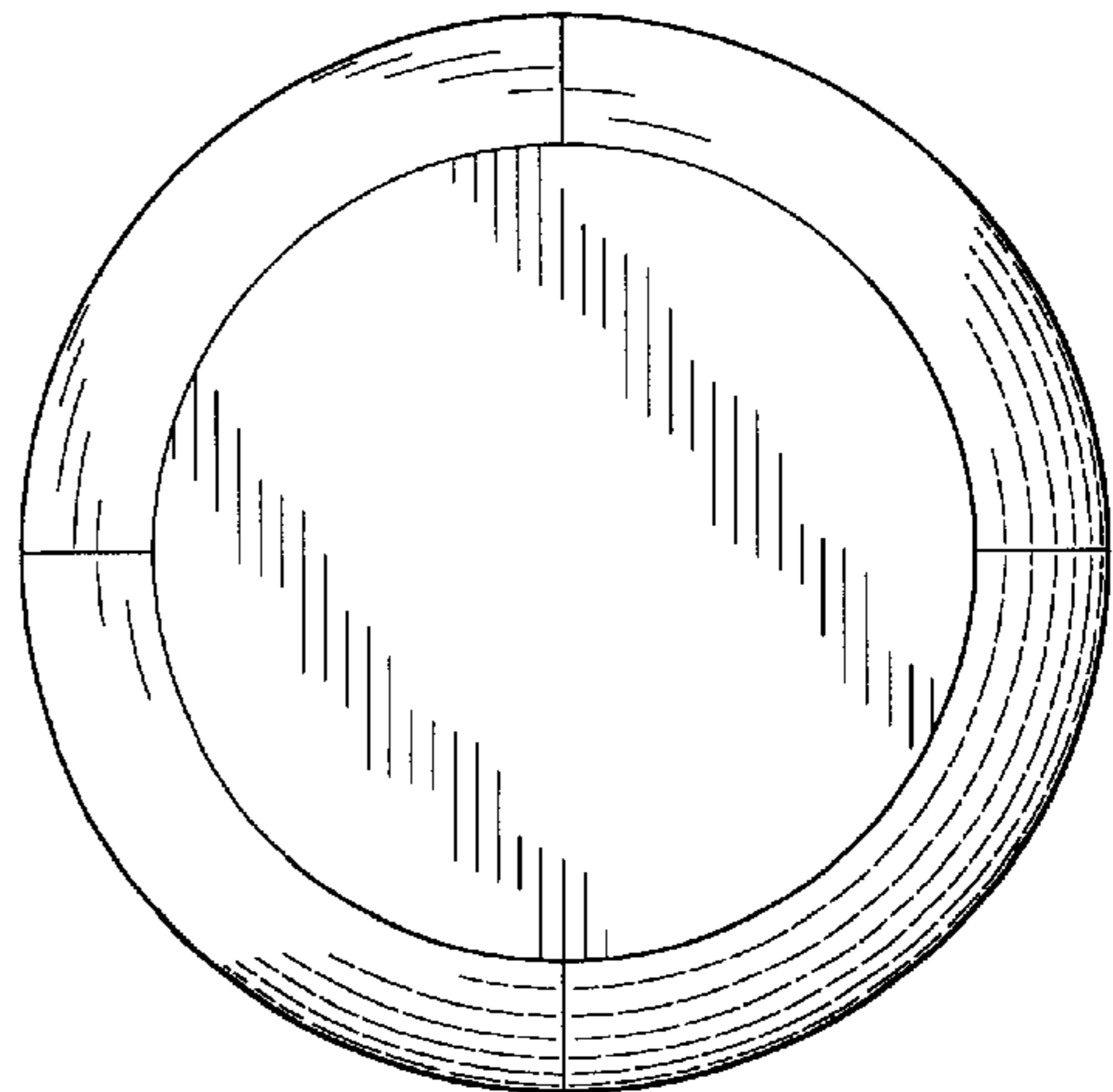

FIG. 36

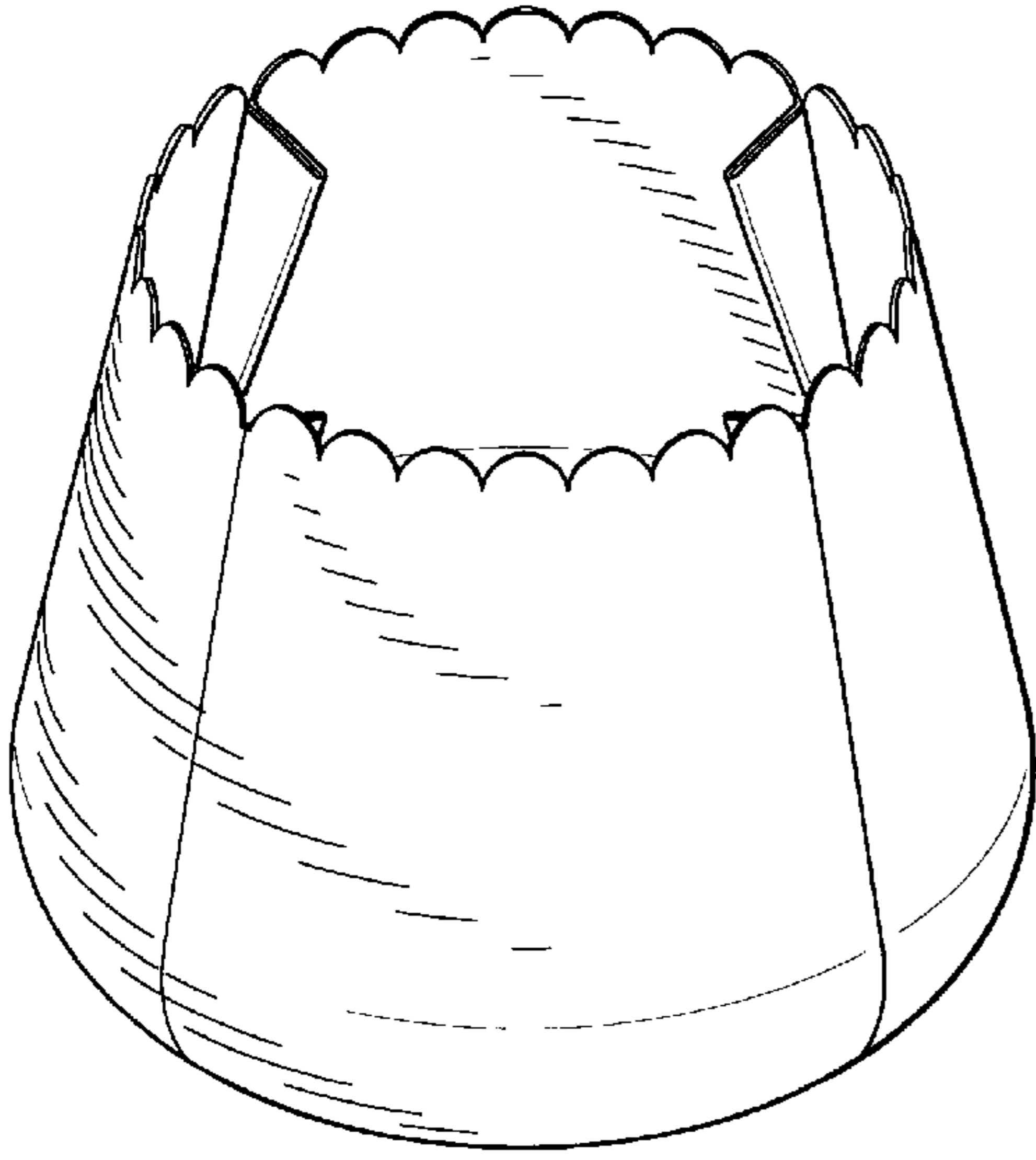

FIG. 37

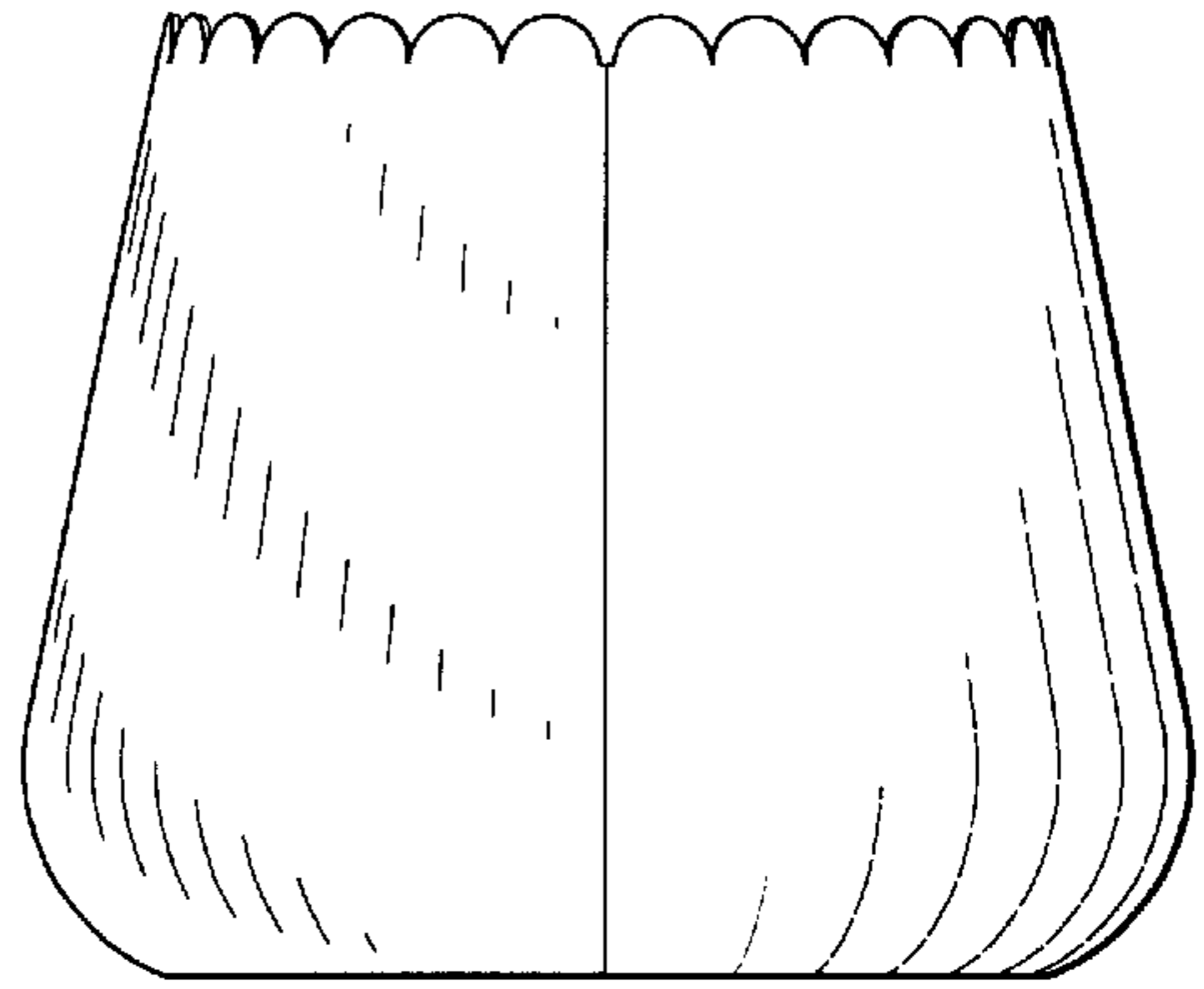

FIG. 38

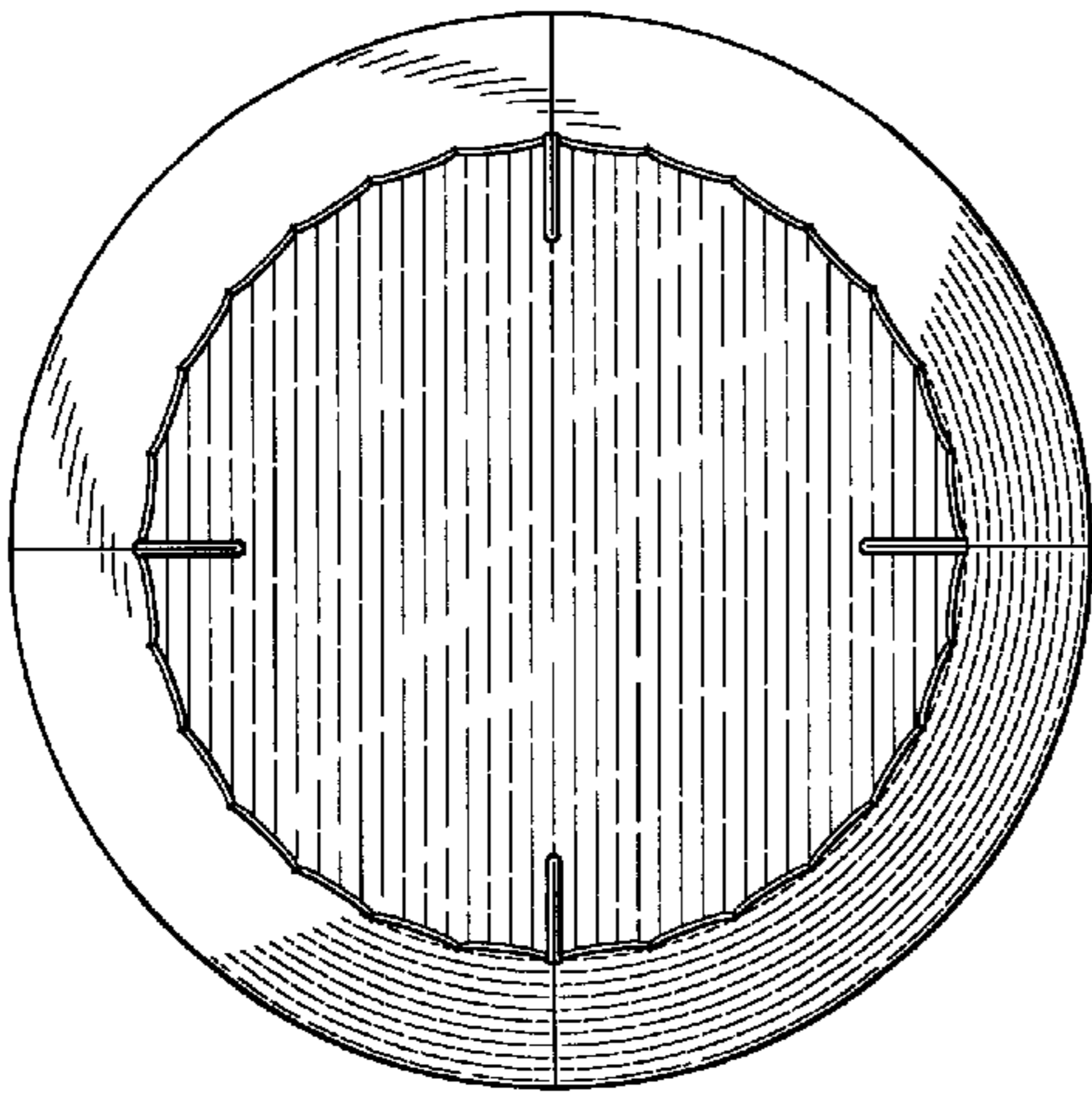

FIG. 39

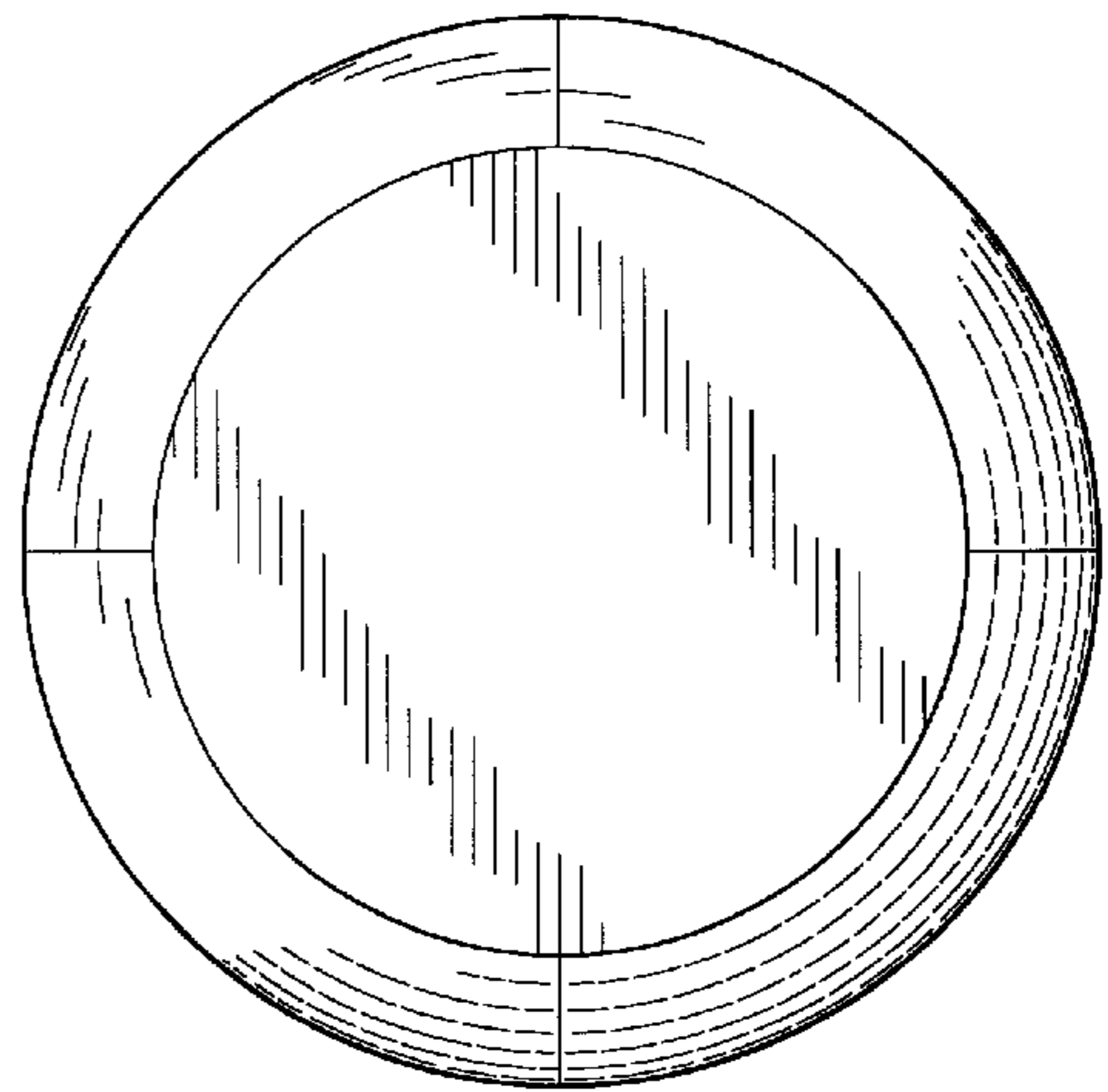

FIG. 40

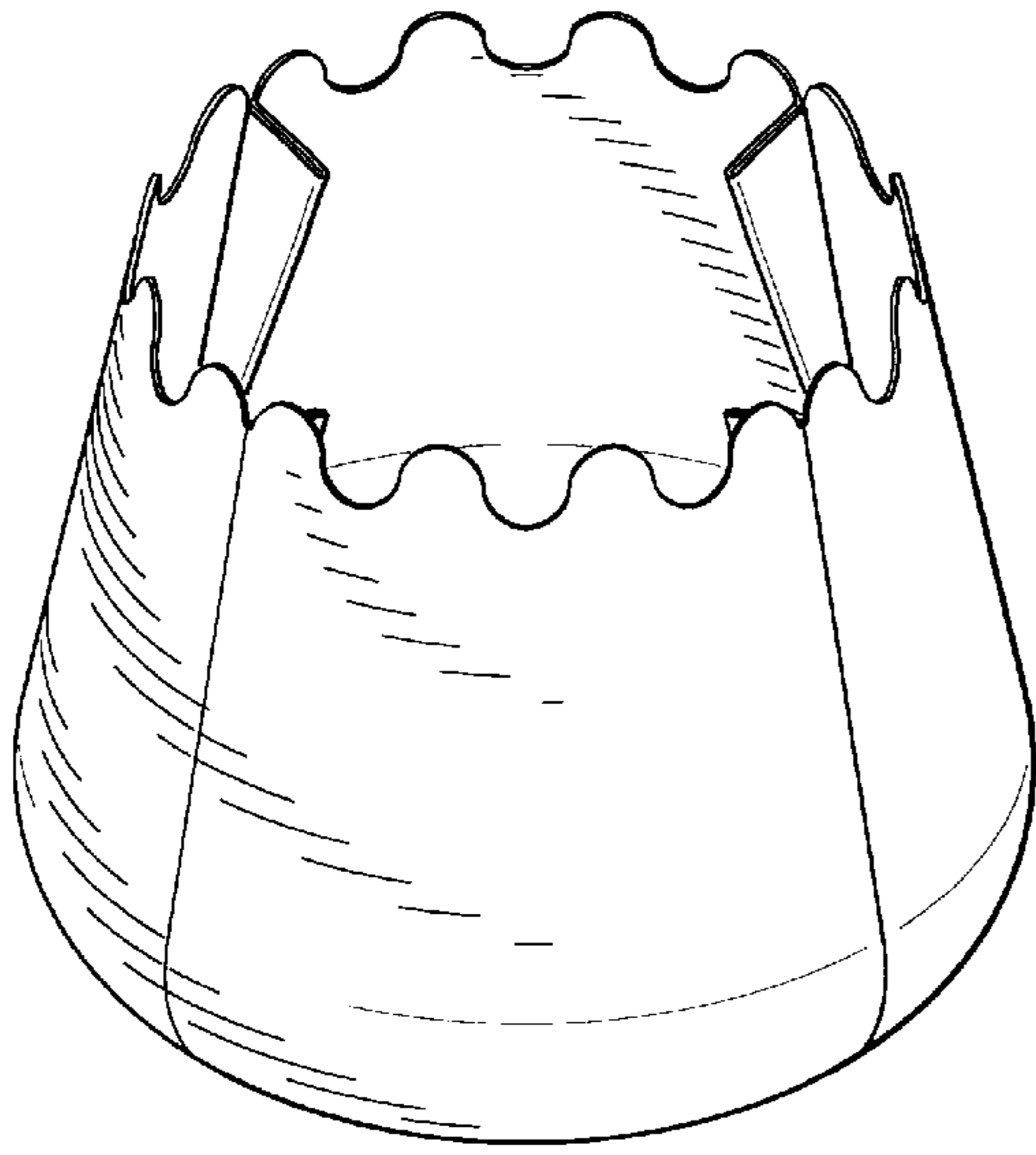

FIG. 41

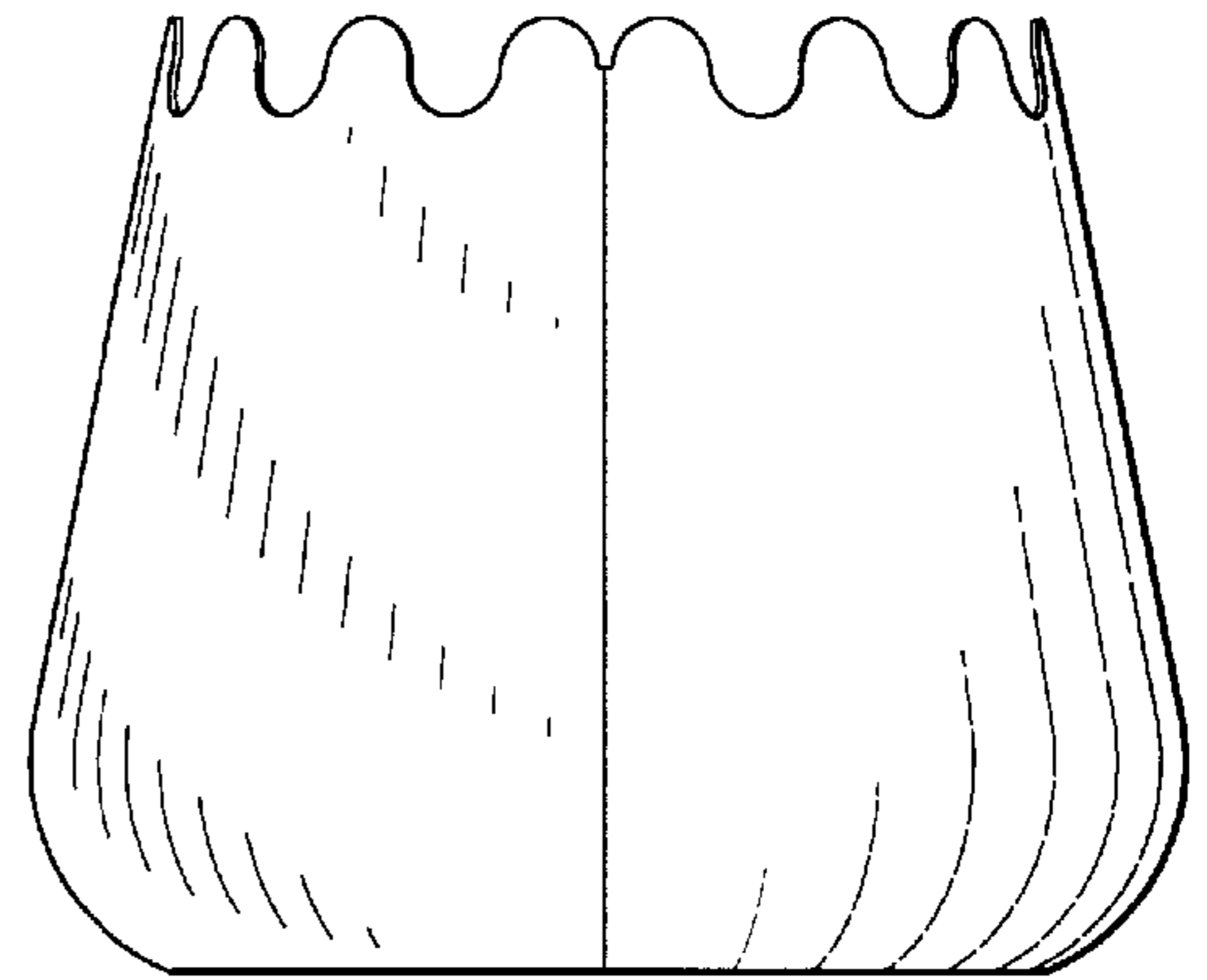

FIG. 42

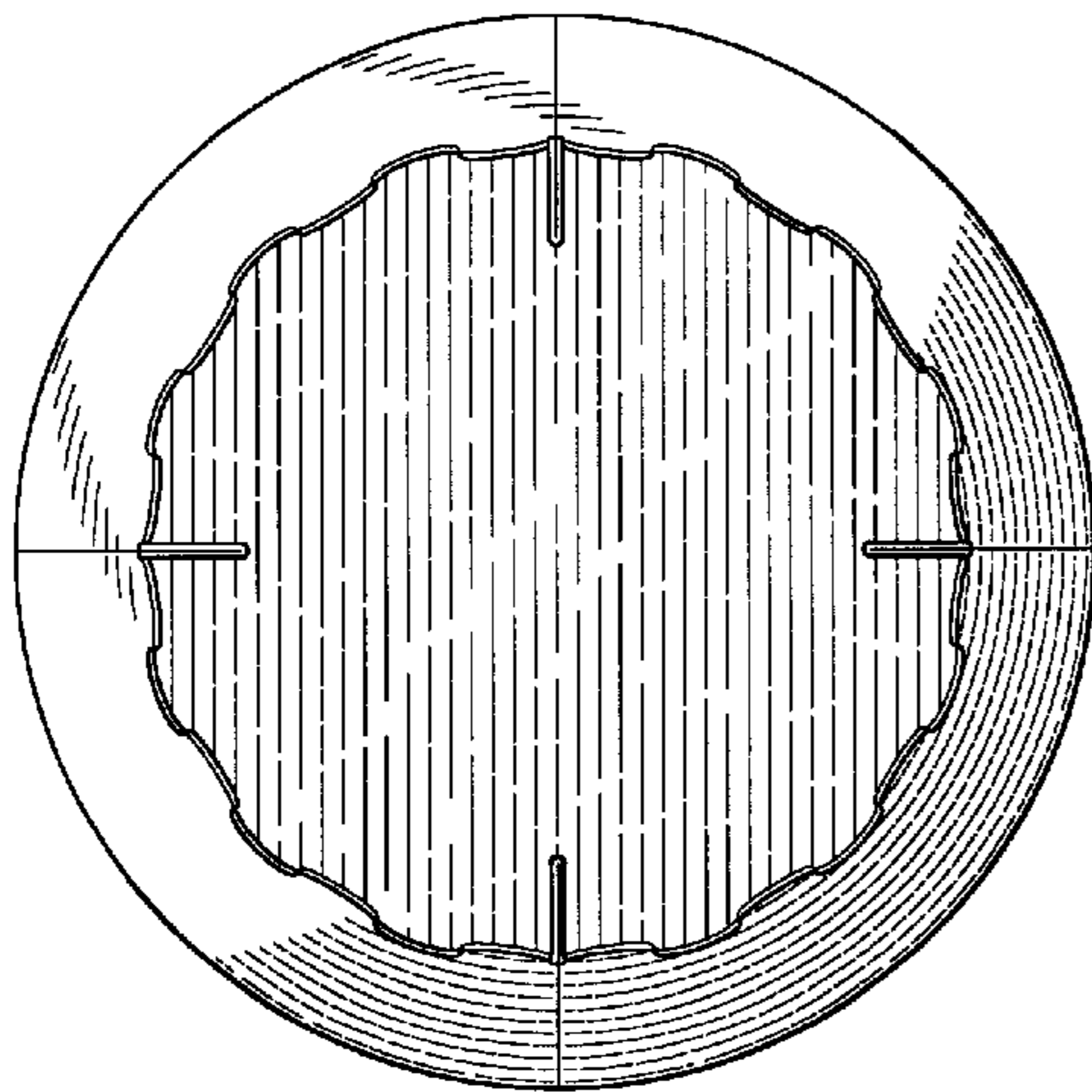

FIG. 43

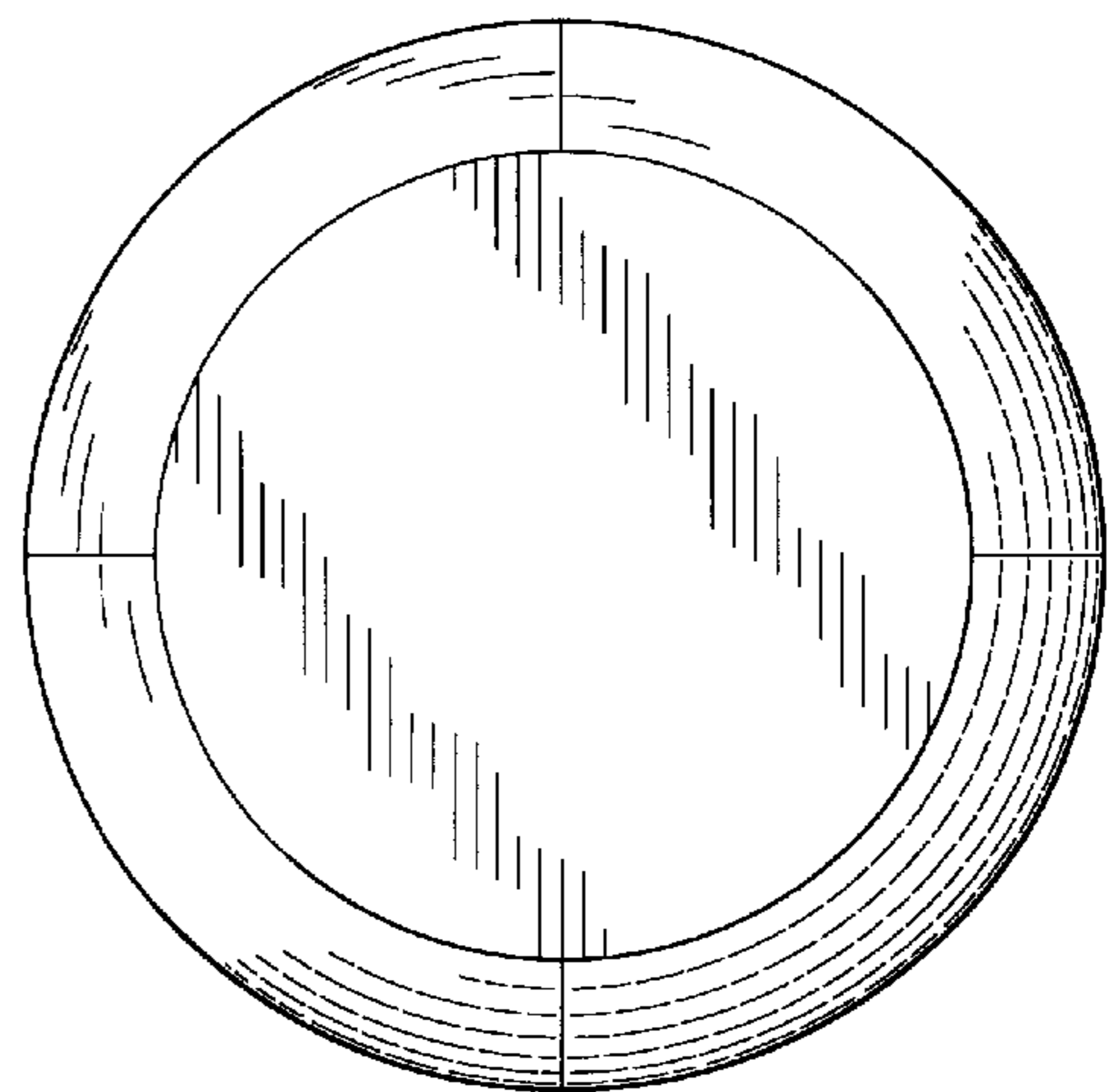

FIG. 44

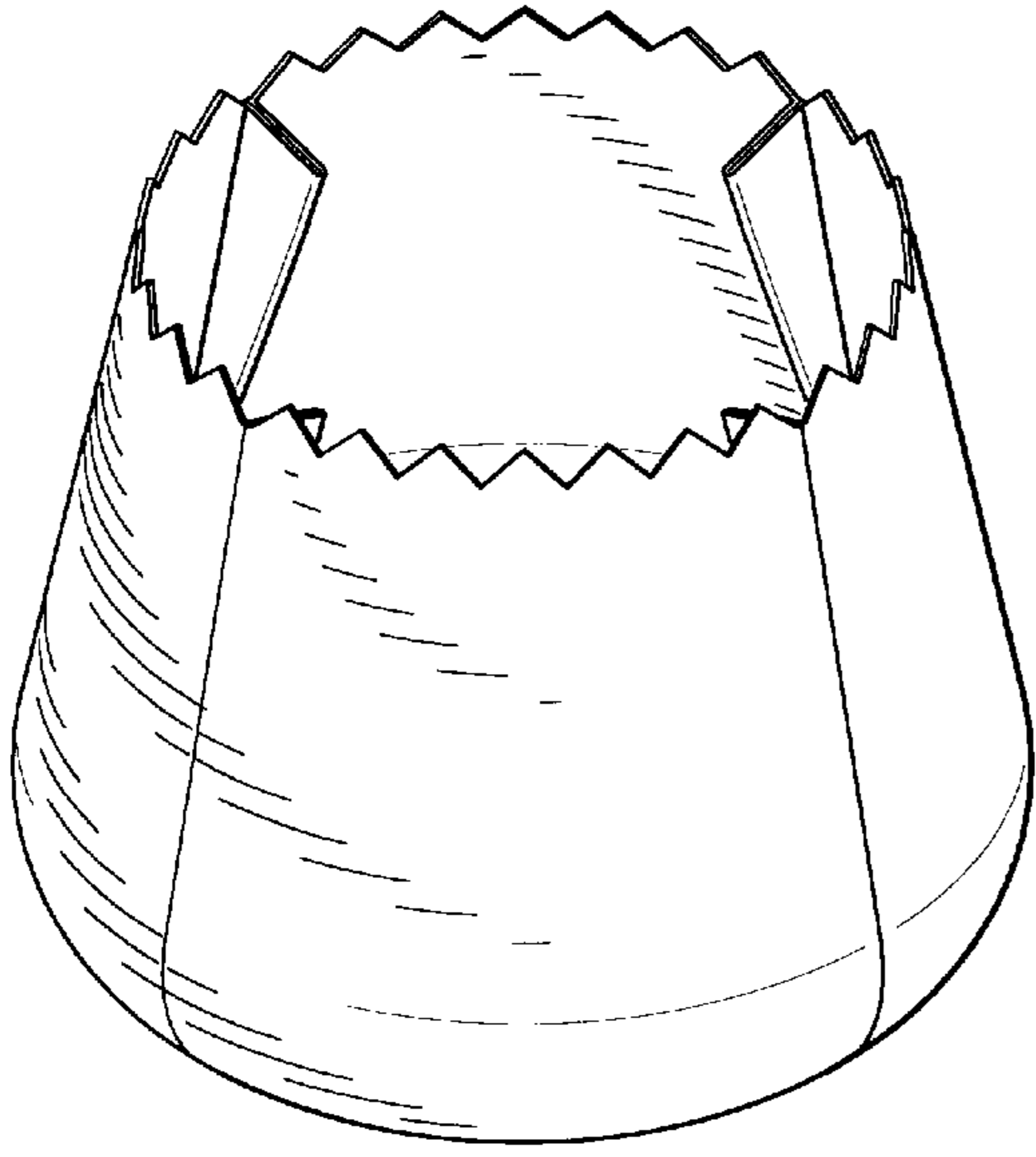

FIG. 45

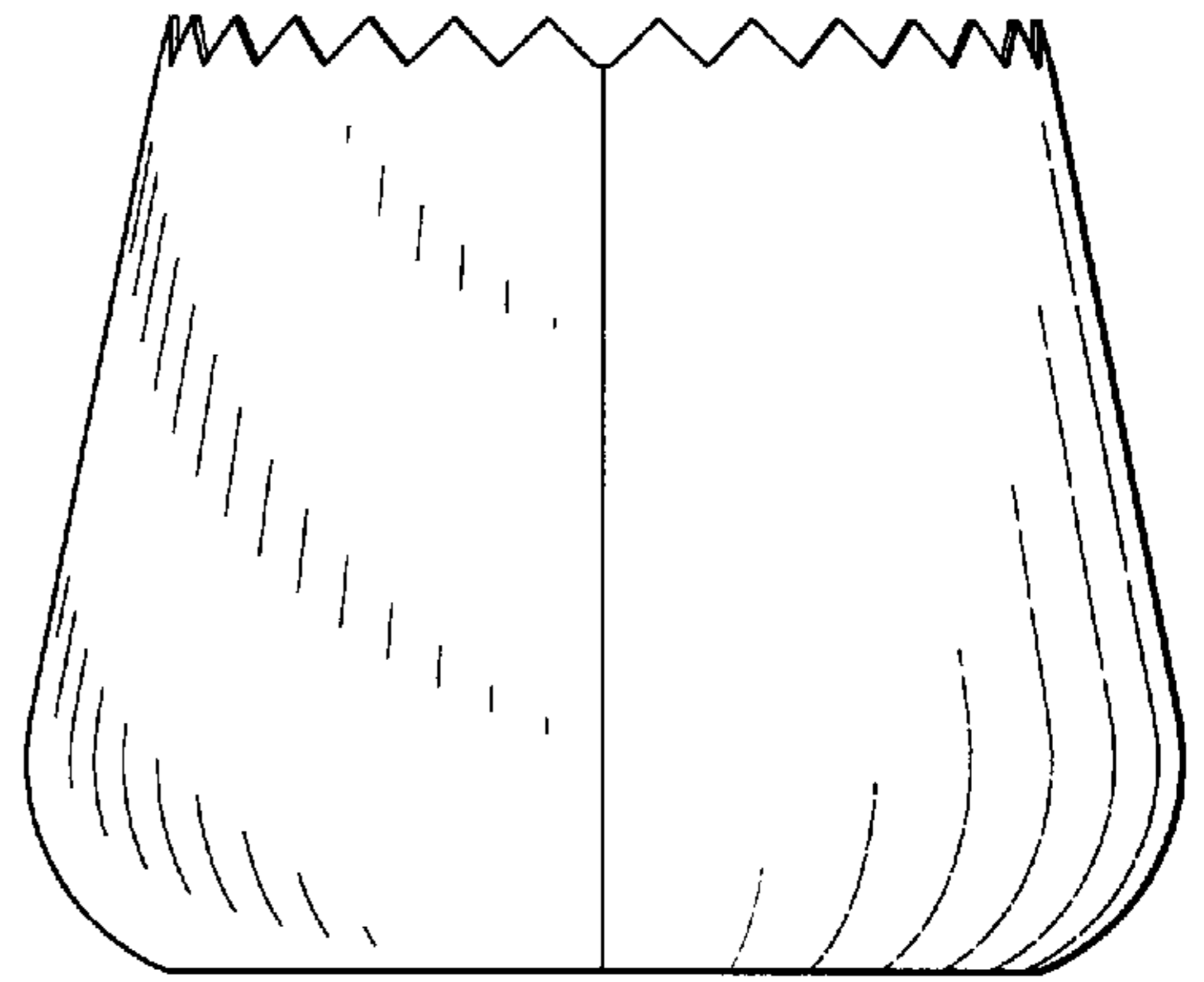

FIG. 46

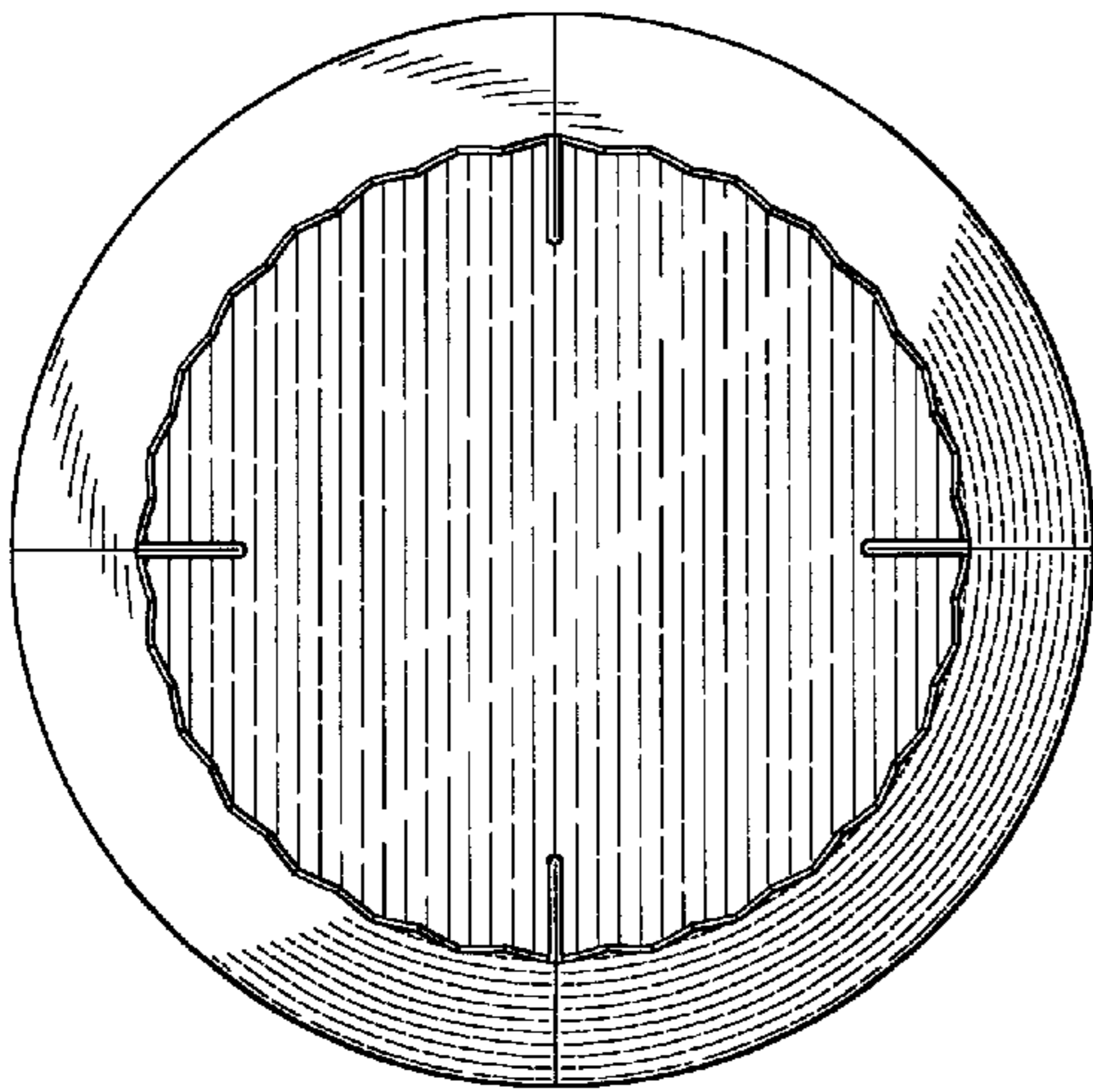

FIG. 47

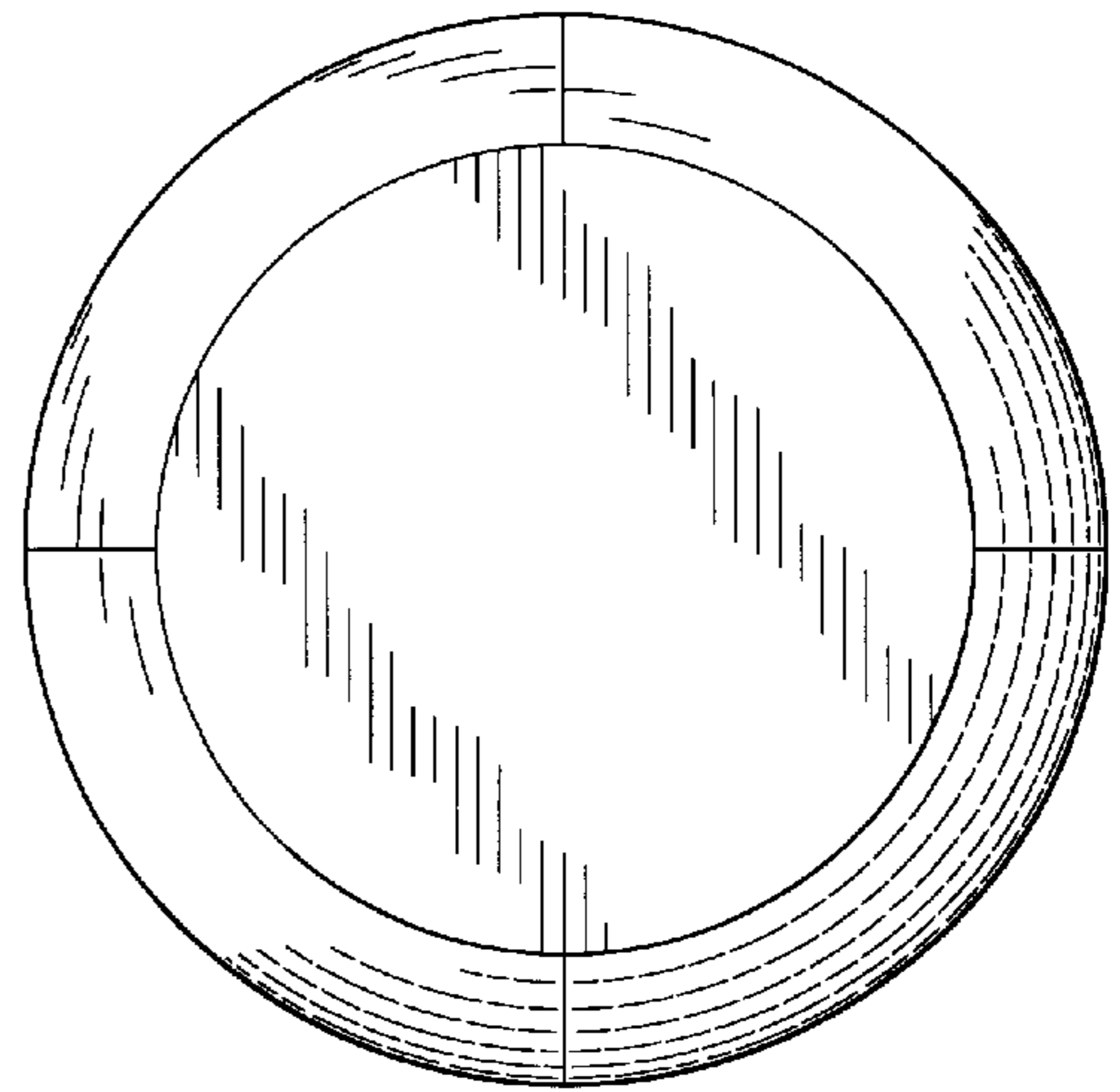

FIG. 48