



US00D403920S

United States Patent [19] Pytlewski

[11] Patent Number: **Des. 403,920**

[45] Date of Patent: ****Jan. 12, 1999**

[54] MIXER BLADE

[76] Inventor: **Walter W. Pytlewski**, 3336 Spain Bridge Rd., Belgrade, Mont. 59714

[**] Term: **14 Years**

[21] Appl. No.: **67,489**

[22] Filed: **Mar. 10, 1997**

[51] LOC (6) Cl. **31-00**

[52] U.S. Cl. **D7/412**

[58] Field of Search D7/376, 379, 387, D7/383, 412; 366/241, 243, 244, 245, 247, 248, 254, 279, 342, 343; 416/223 R

[56] References Cited

U.S. PATENT DOCUMENTS

| | | | | |
|------------|---------|----------|-------|----------|
| D. 124,192 | 12/1940 | Carman | | D7/412 |
| D. 321,811 | 11/1991 | Littmann | | D7/379 |
| D. 366,596 | 1/1996 | Hewin | | D7/412 |
| D. 372,632 | 8/1996 | Riskin | | D7/379 |
| 3,154,297 | 10/1964 | Lovgren | | D7/412 X |

Primary Examiner—Caron D. Veynar

Attorney, Agent, or Firm—Robert Louis Finkel

[57] CLAIM

The ornamental design for a mixer blade, as shown and described.

DESCRIPTION

FIG. 1 is a top perspective view of a mixer blade embodying my new design;

FIG. 2 is a side view of one of the four substantially identical sides of the mixer blade of FIG. 1; and

FIG. 3 is a top view of the mixer blade of FIG. 1, the bottom view being a mirror image thereof;

FIG. 4 is a top perspective view of a second embodiment of the mixer blade embodying my new design;

FIG. 5 is a top view of the mixer blade of FIG. 4, the bottom view being a mirror image thereof;

FIG. 6 is a side view of one of the four substantially identical sides of the mixer blade of FIG. 4; and

FIG. 7 is a top perspective view of a third embodiment of the mixer blade embodying my new design;

FIG. 8 is a top view of the mixer blade of FIG. 7, the bottom view being a mirror image thereof;

FIG. 9 is a side view of one of the four substantially identical sides of the mixer blade of FIG. 7;

FIG. 10 is a top perspective view of a fourth embodiment of the mixer blade embodying my new design;

FIG. 11 is a top view of the mixer blade of FIG. 10, the bottom view being a mirror image thereof;

FIG. 12 is a side view of one of the four substantially identical sides of the mixer blade of FIG. 10;

FIG. 13 is a top perspective view of a fifth embodiment of the mixer blade embodying my new design;

FIG. 14 is a top view of the mixer blade of FIG. 13, the bottom view being a mirror image thereof; and,

FIG. 15 is a side view of one of the four substantially identical sides of the mixer blade of FIG. 13.

The broken line showing of a shaft in all of the drawings is for illustrative purposes only and forms no part of the claimed design.

1 Claim, 5 Drawing Sheets

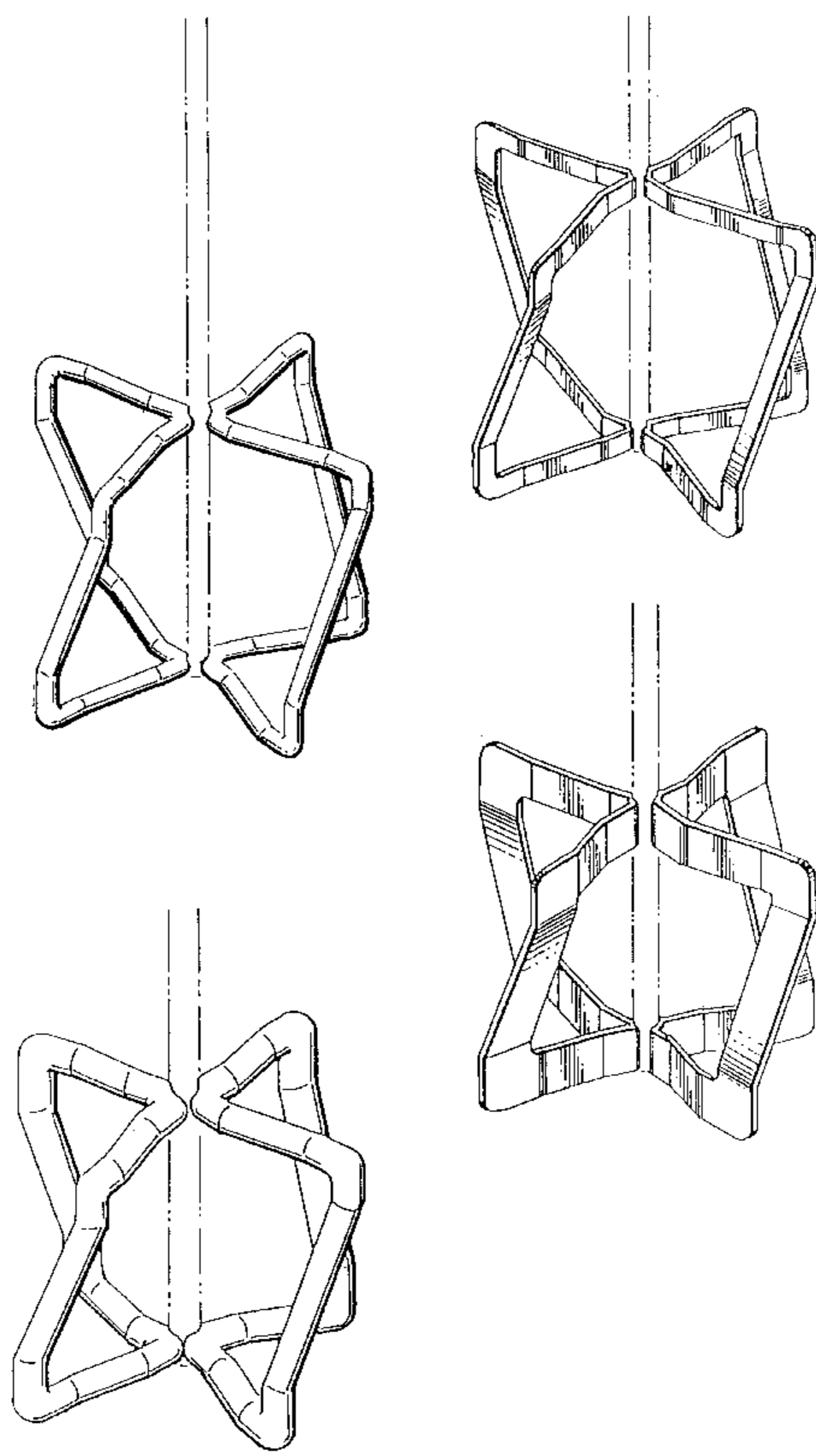

FIG. 1

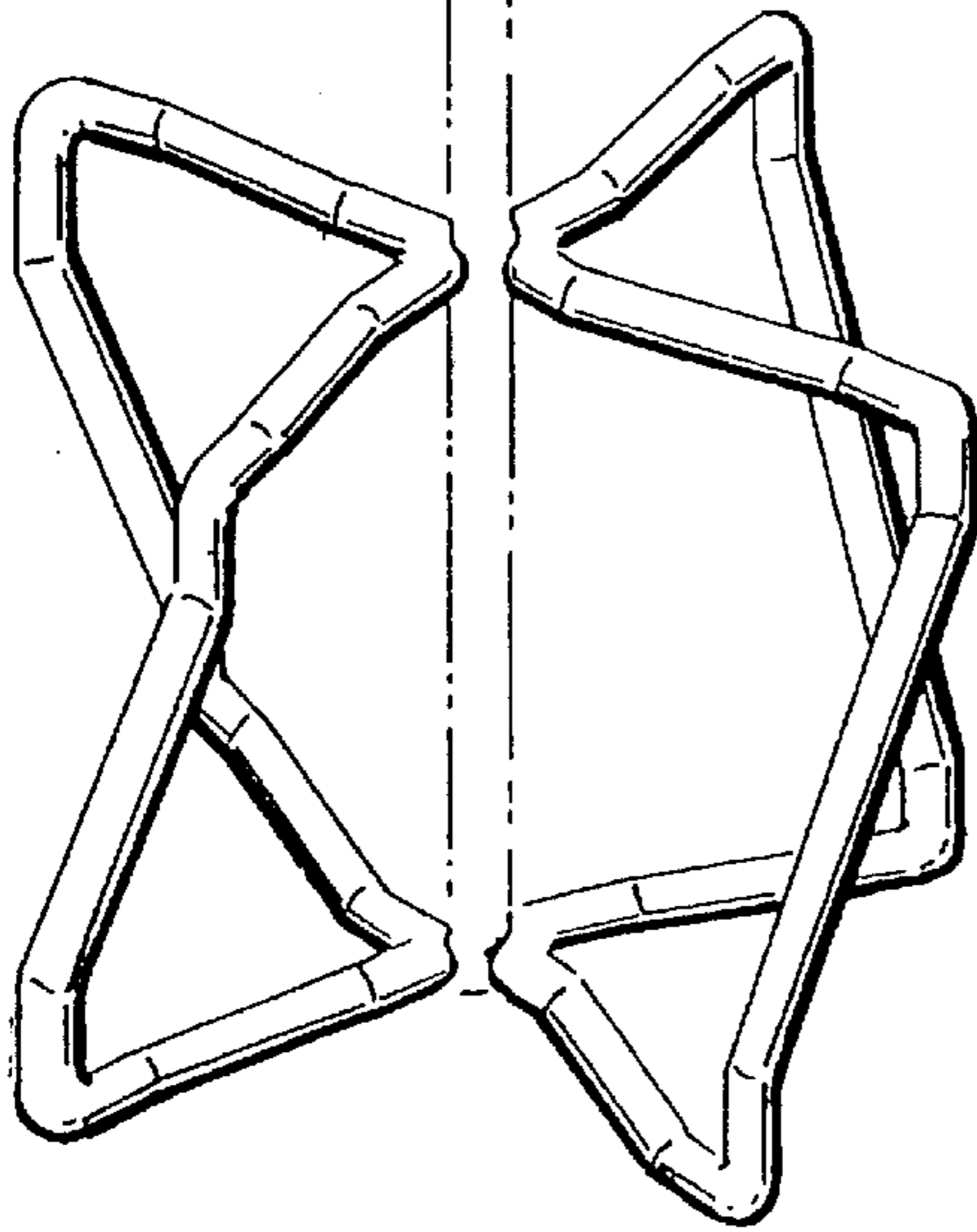

FIG. 2

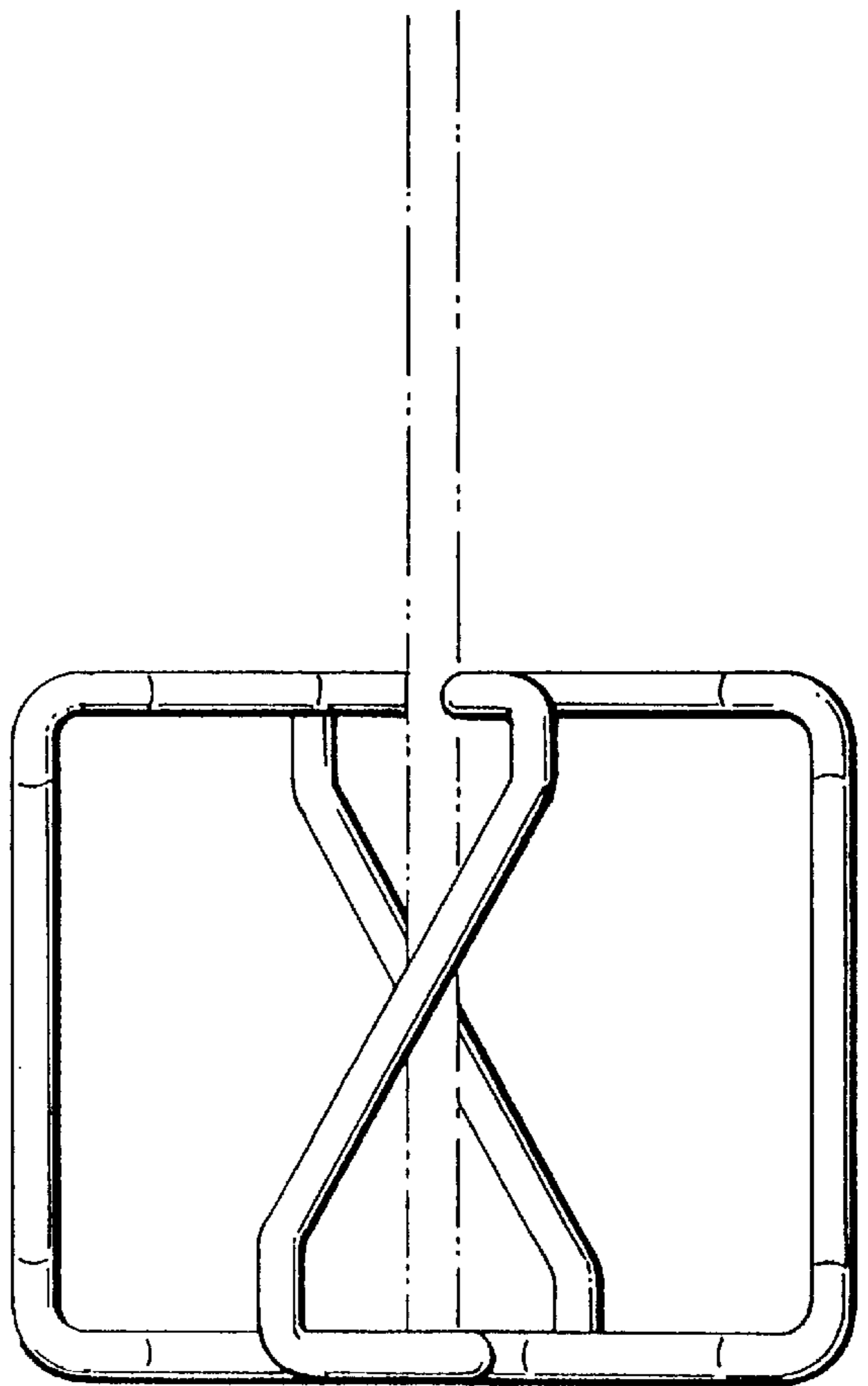

FIG. 3

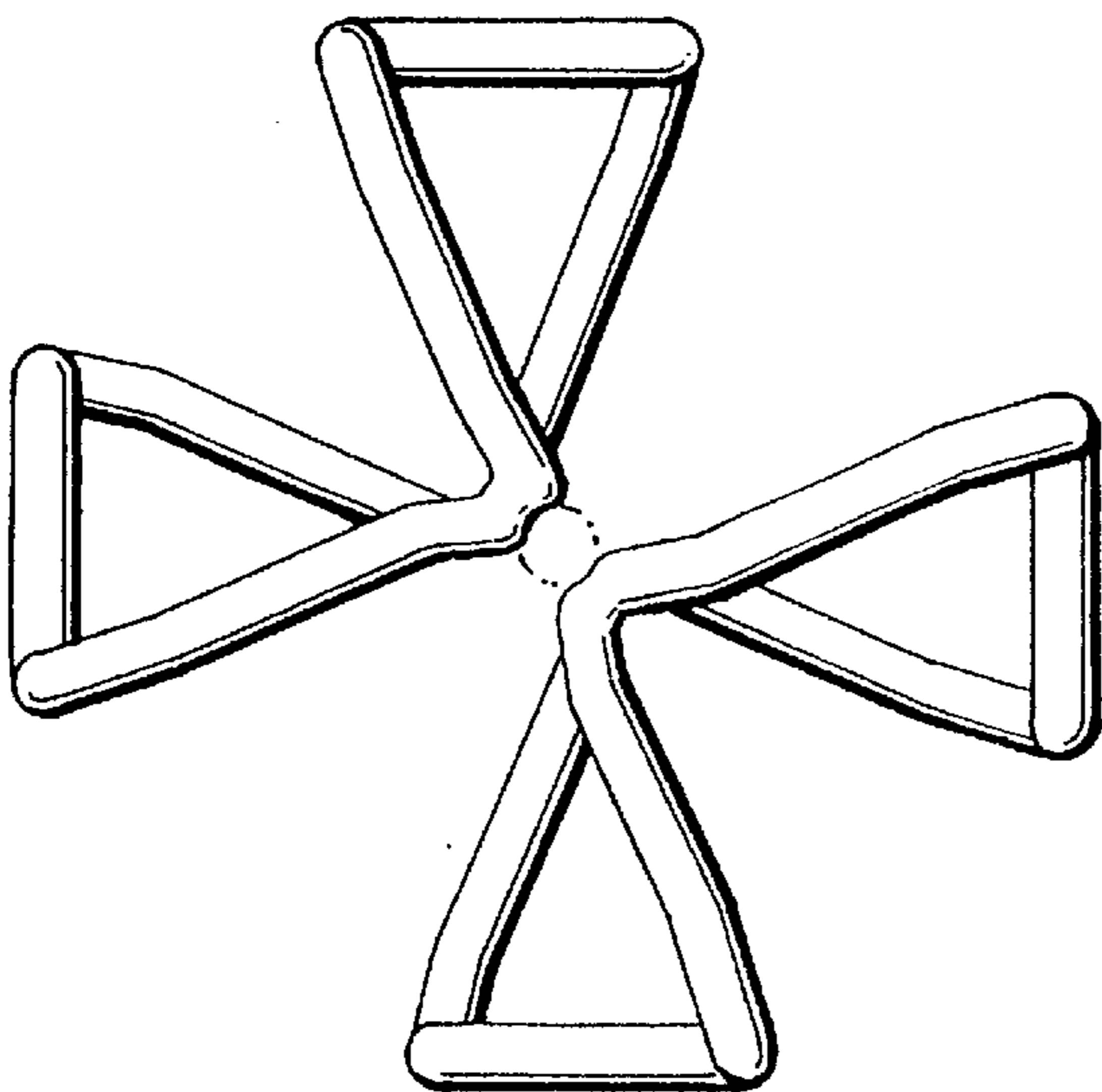

FIG. 4

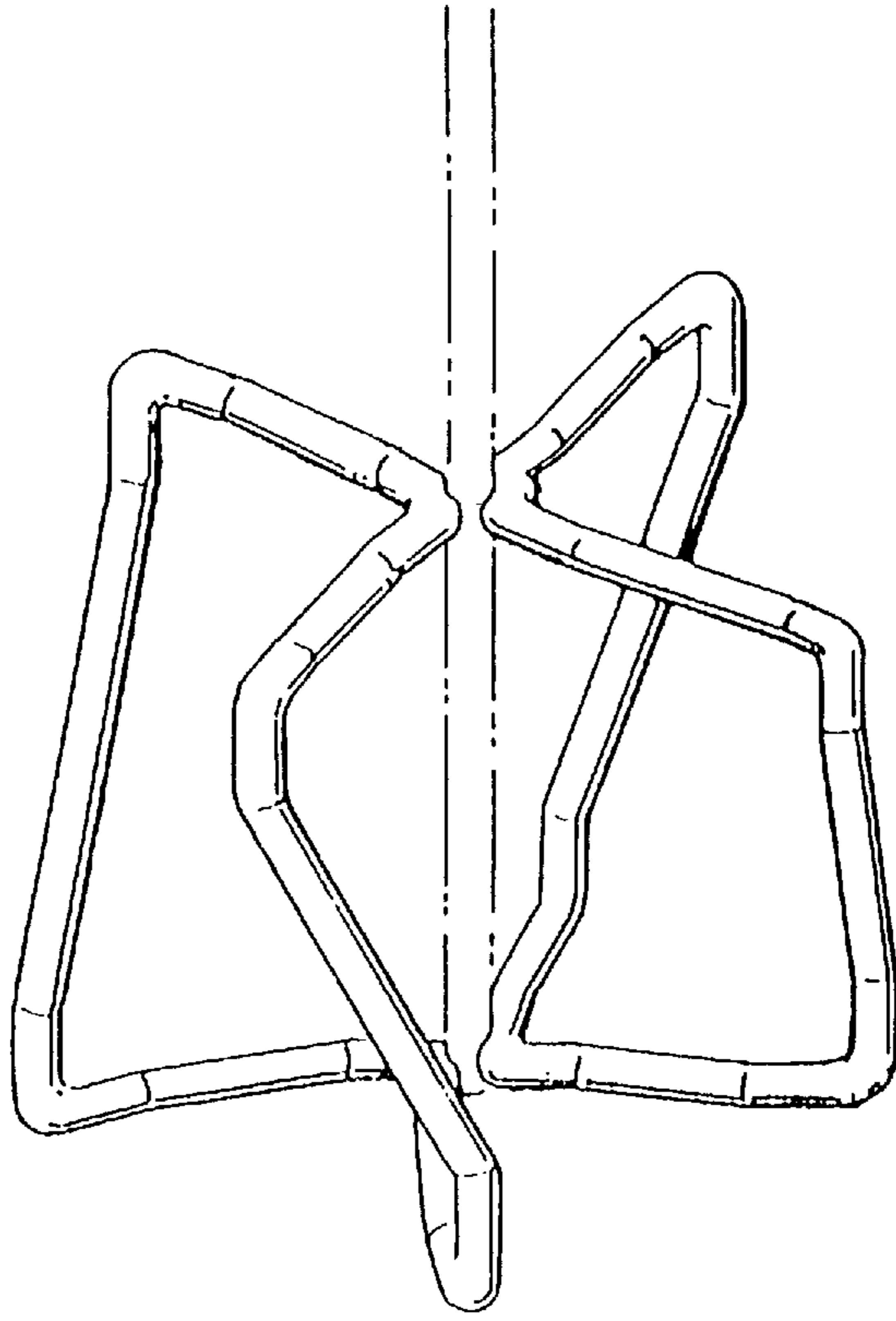

FIG. 5

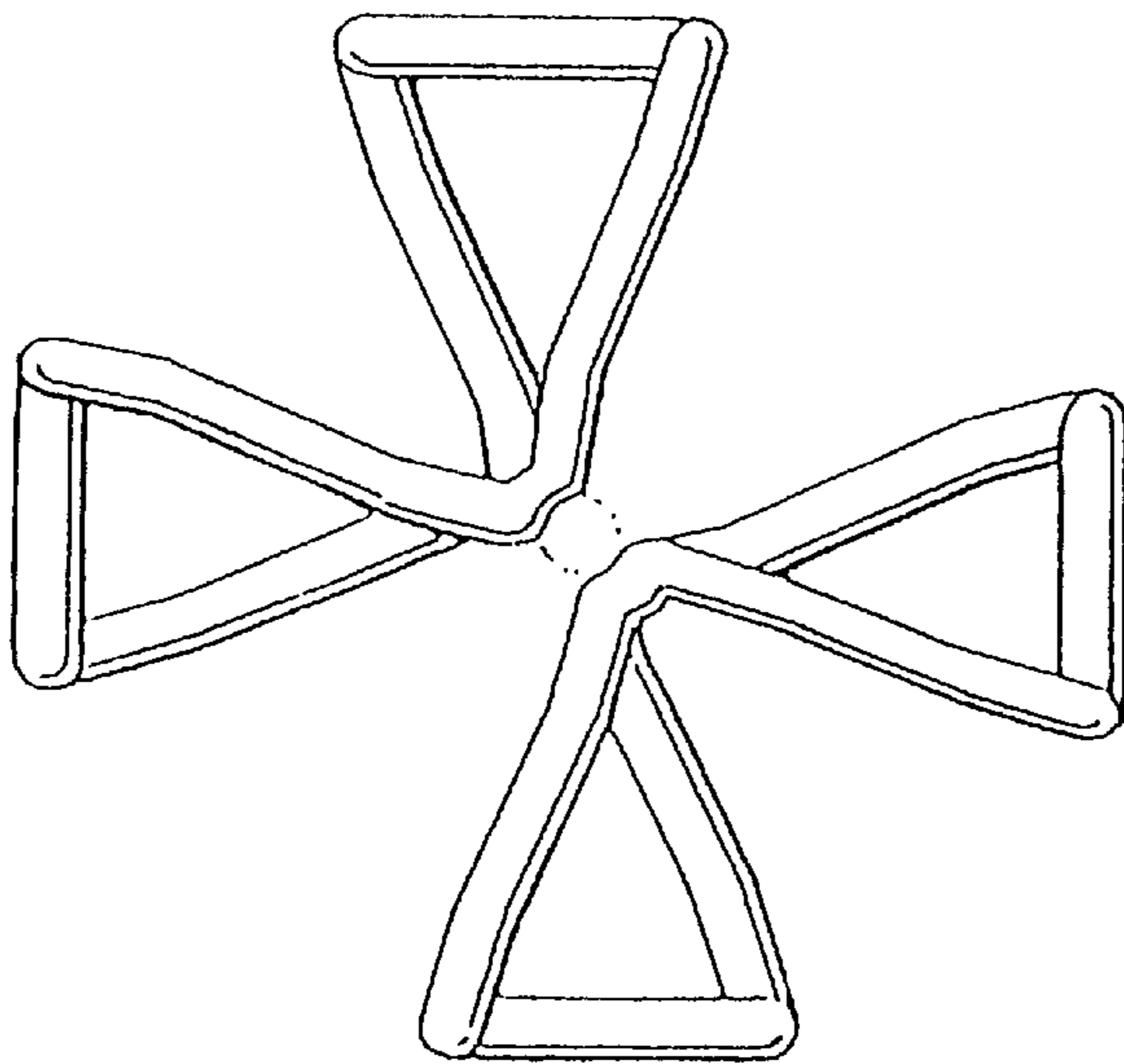

FIG. 6

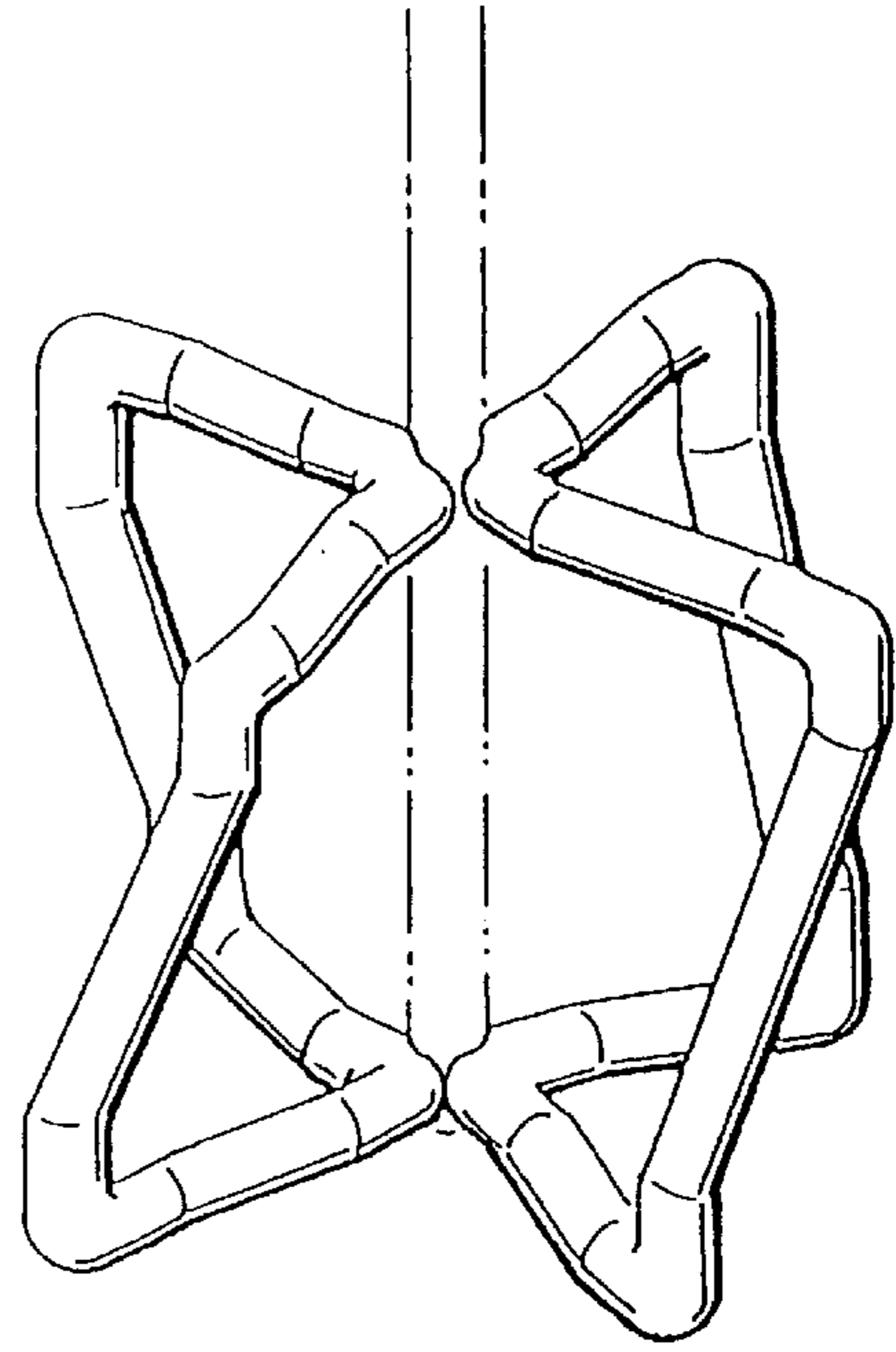
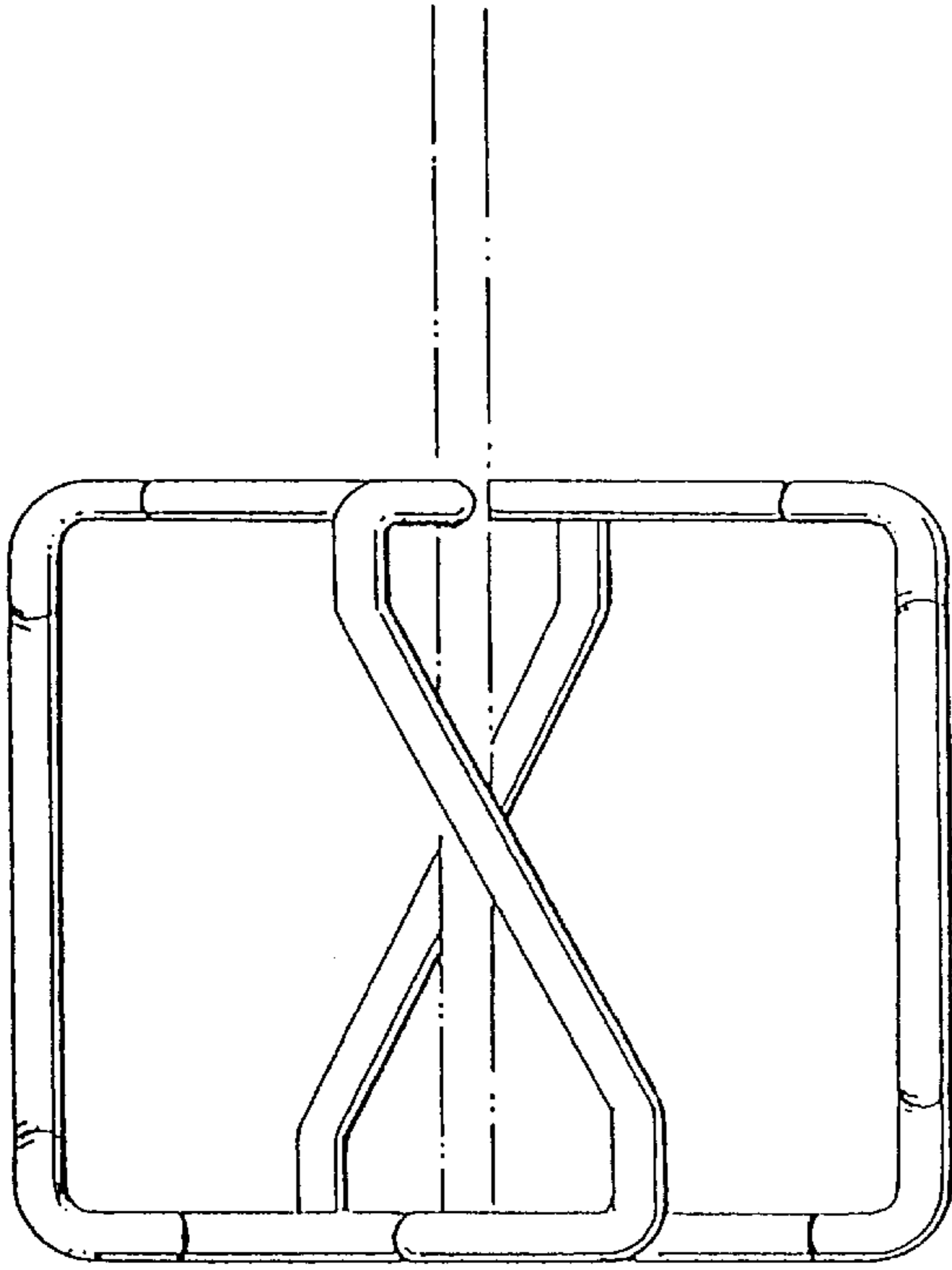

FIG. 7

FIG. 8

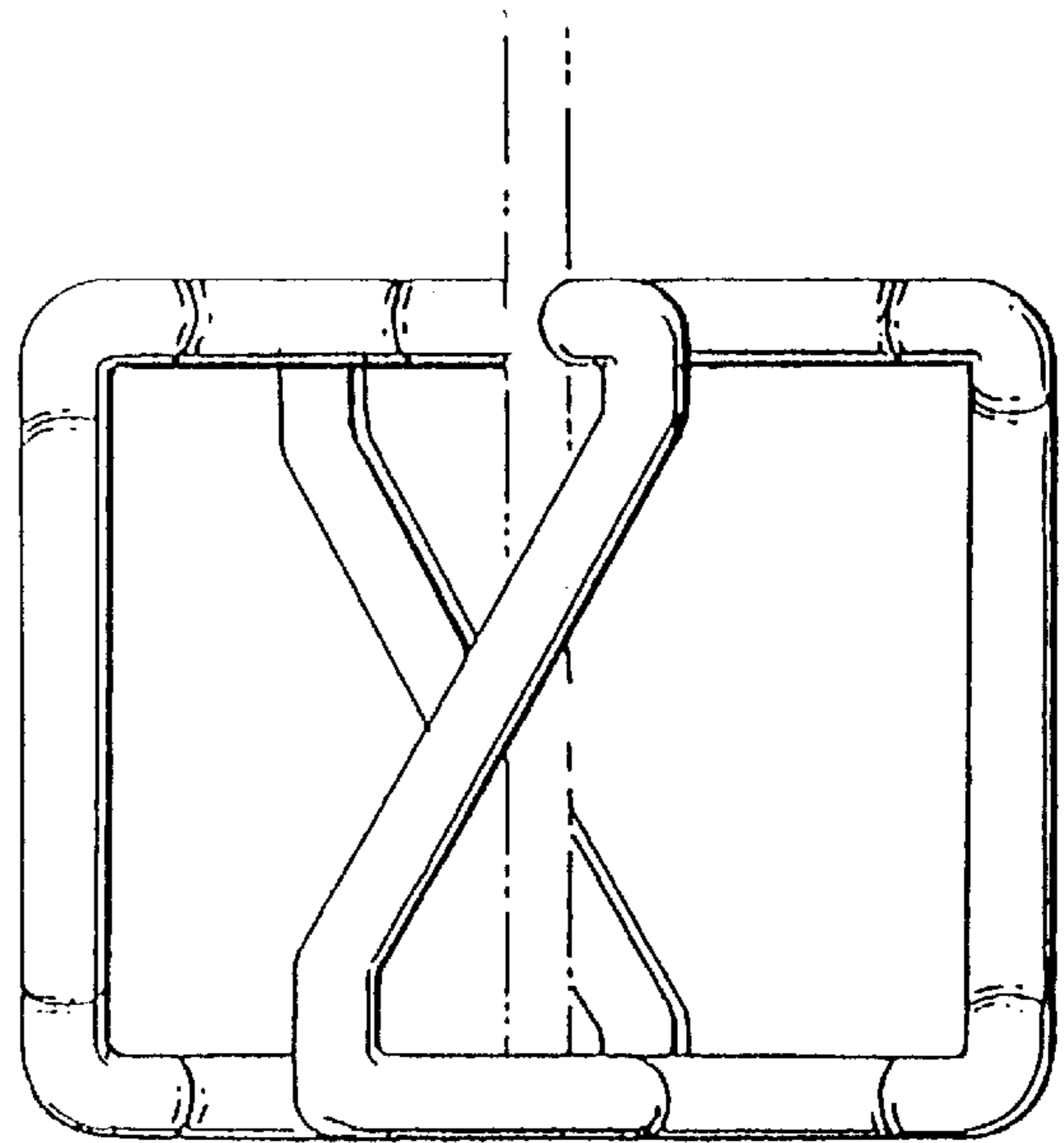
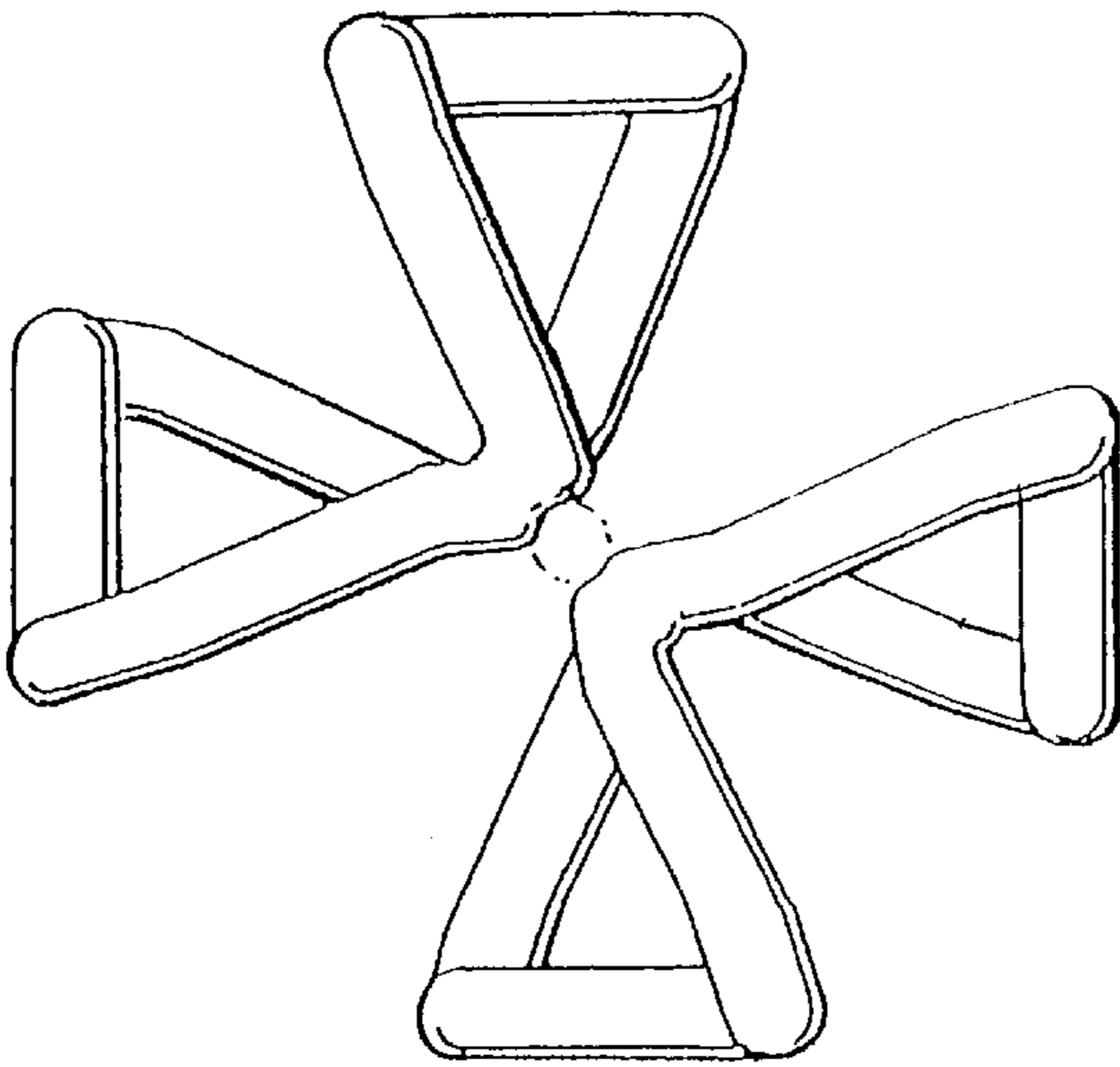

FIG. 9

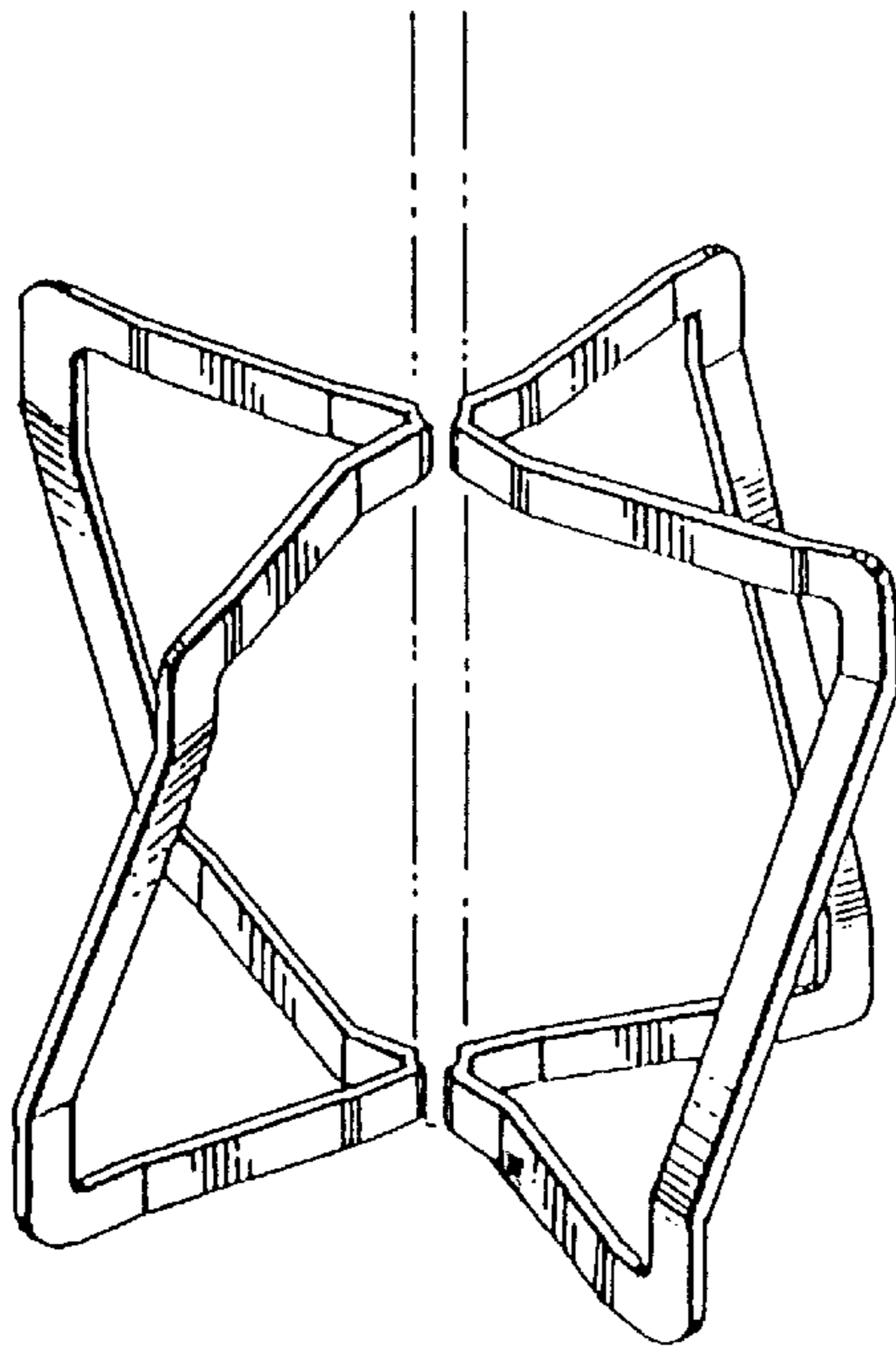

FIG. 10

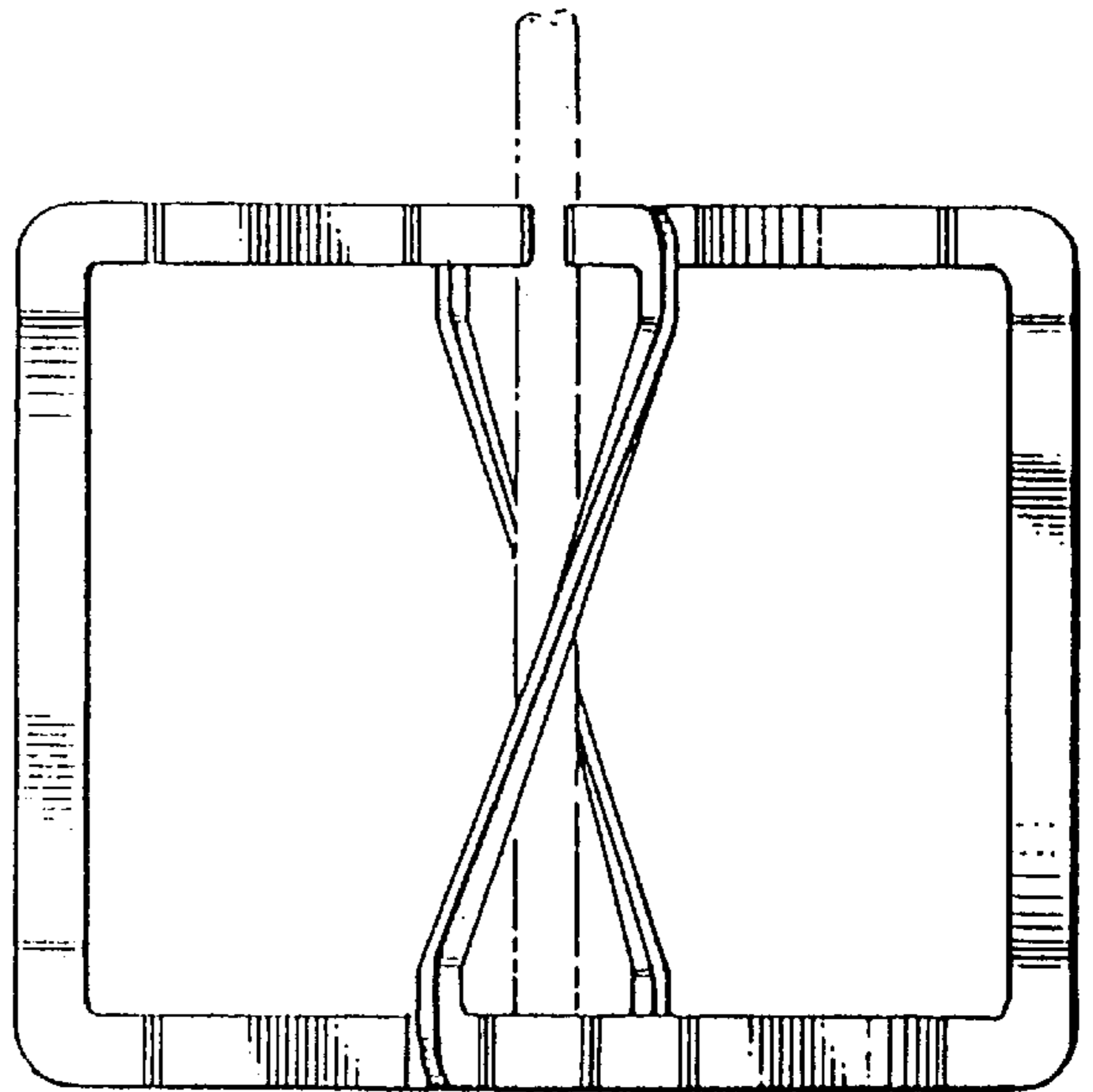

FIG. 12

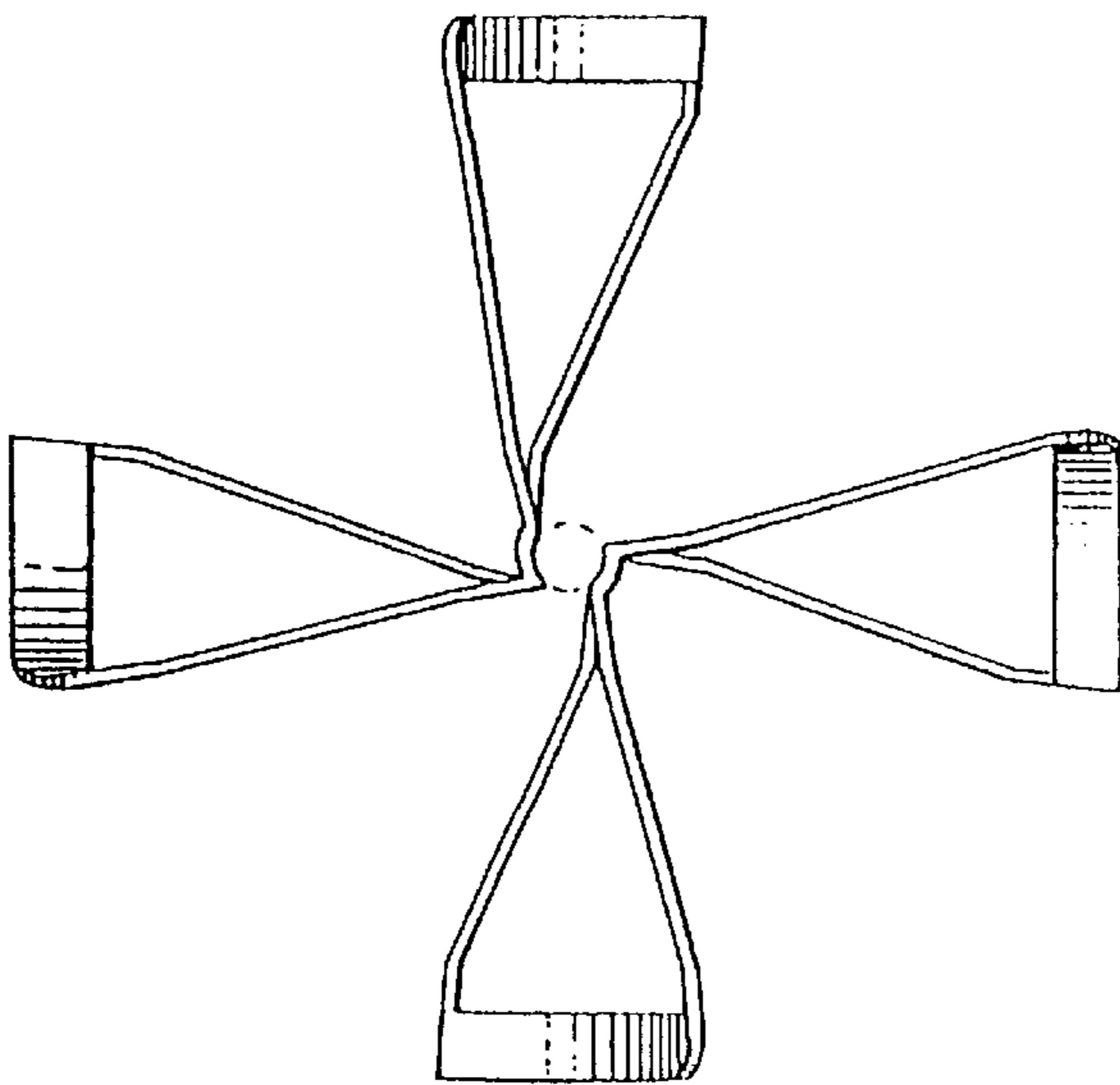

FIG. 11

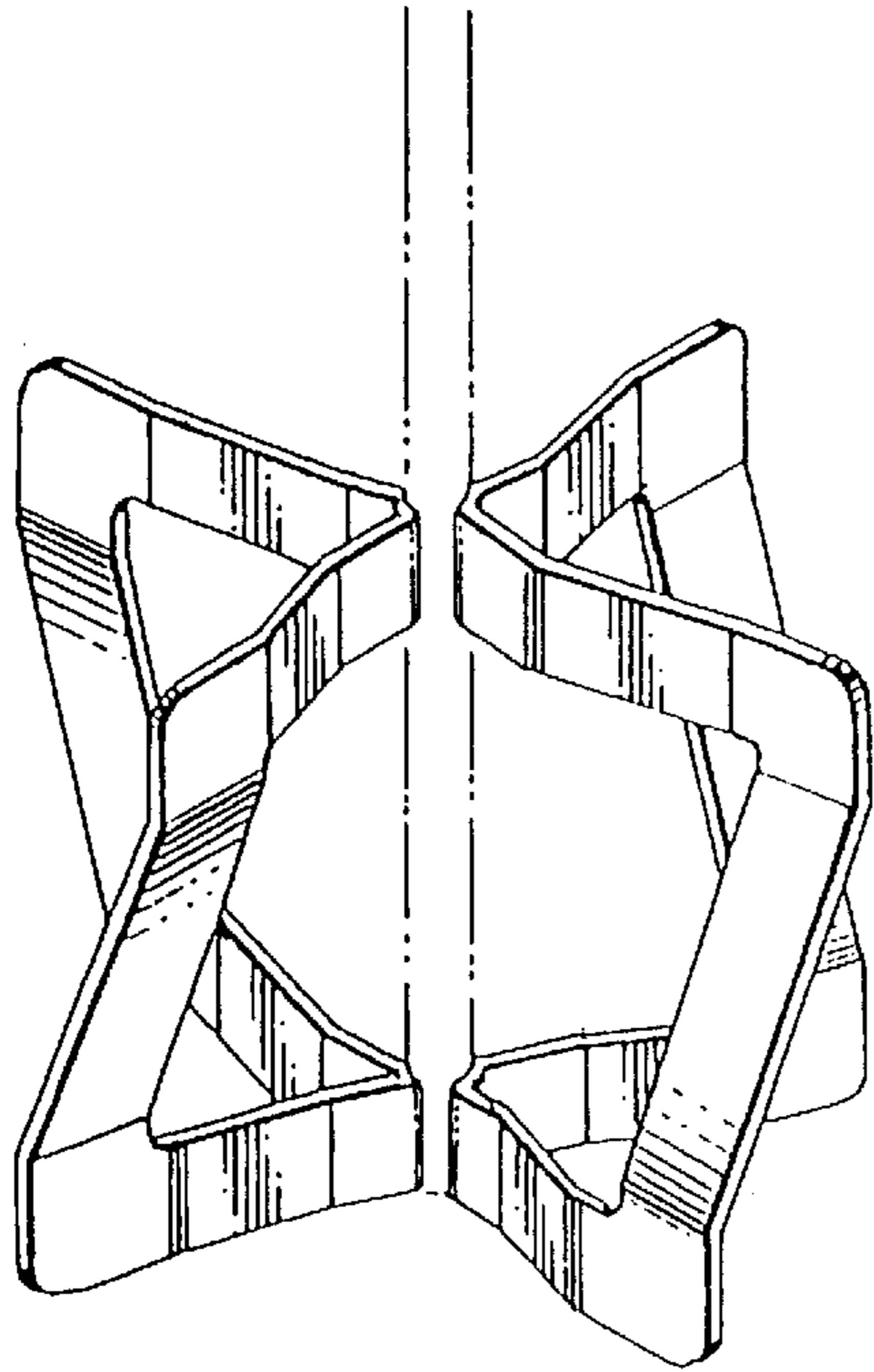

FIG. 13

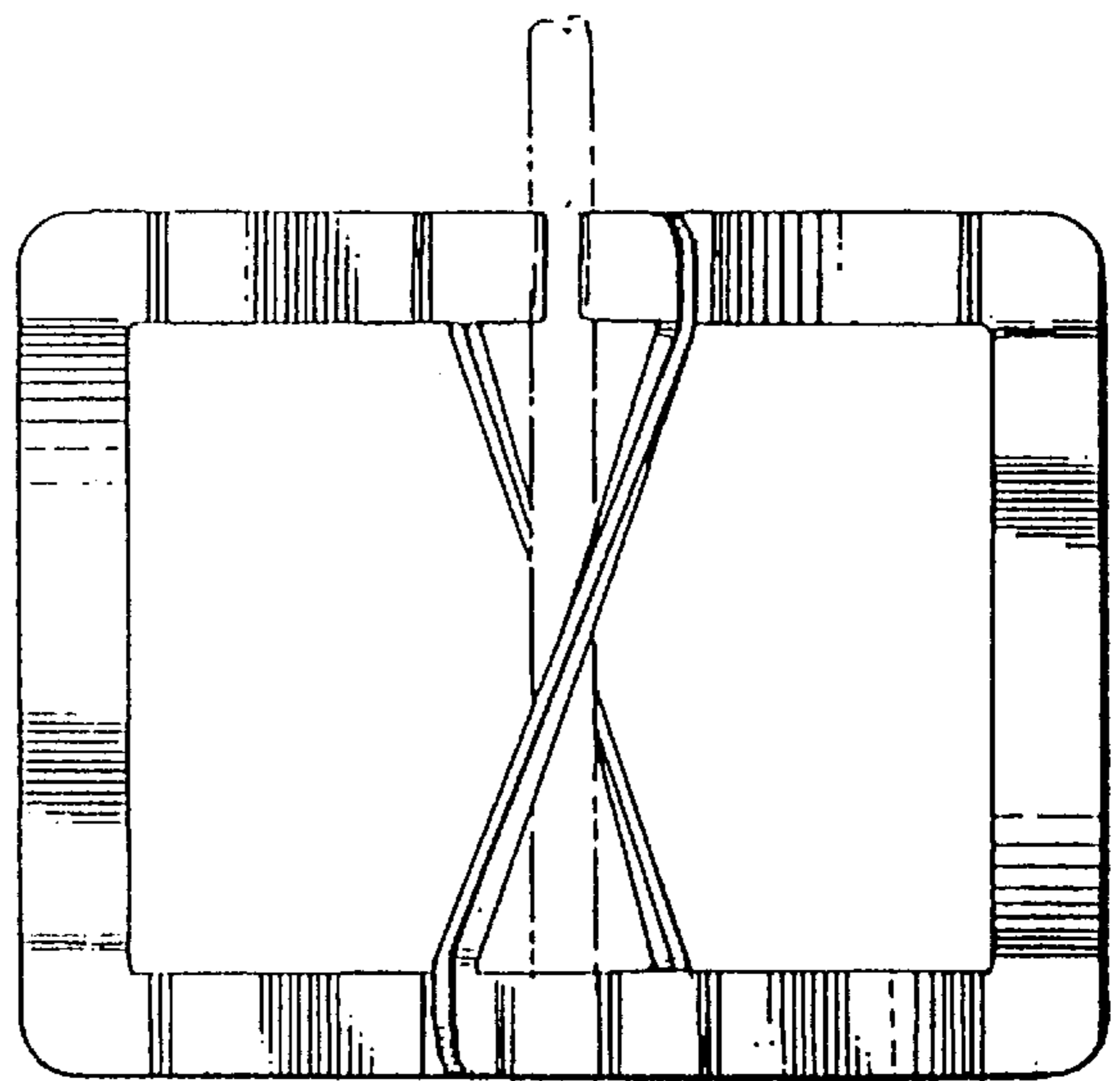

FIG. 15

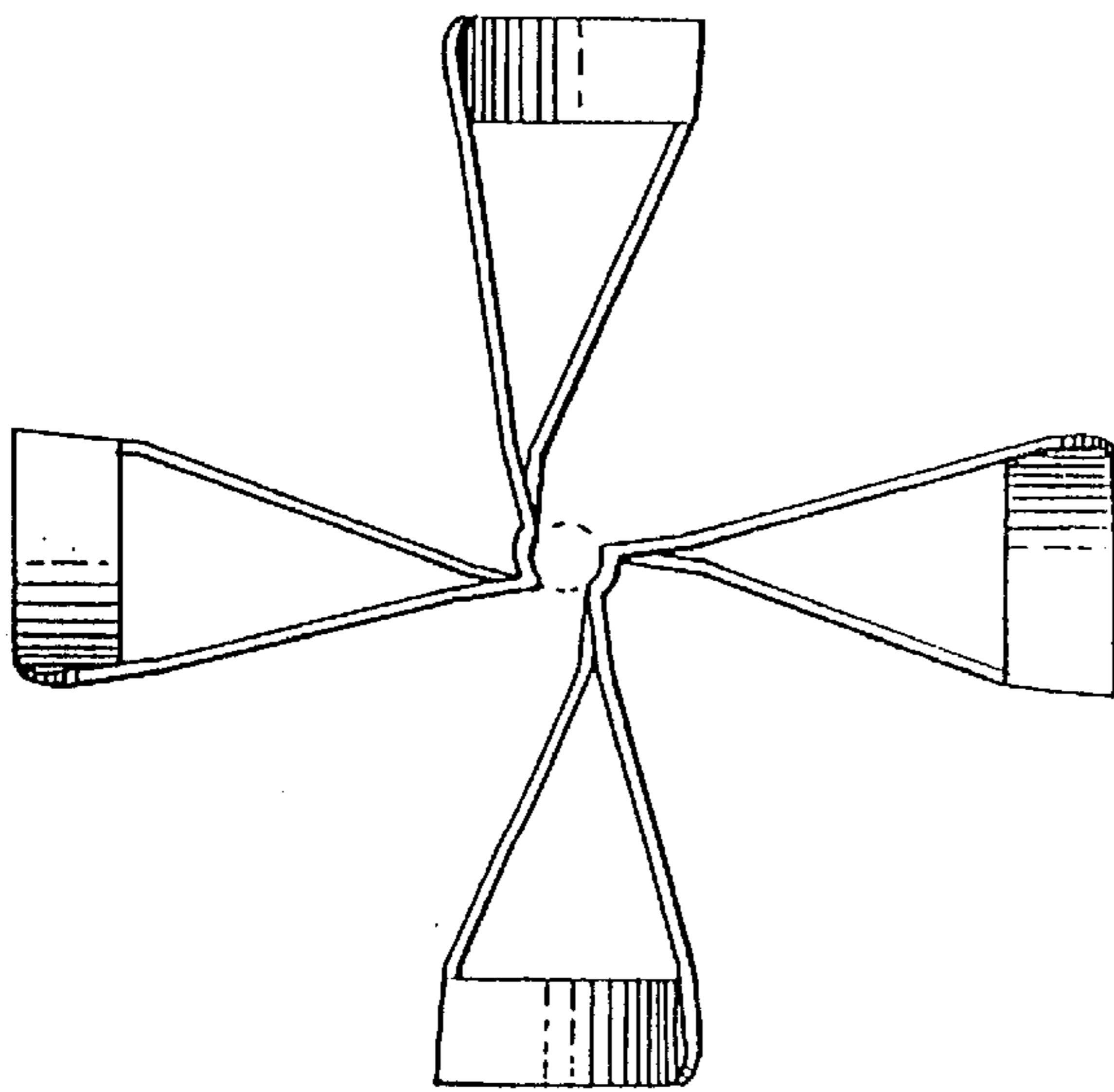

FIG. 19