



US00D403880S

United States Patent [19] Malik

[11] **Patent Number: Des. 403,880**
[45] **Date of Patent: **Jan. 12, 1999**

[54] **MODULAR STORAGE RACK FOR SHOES**

[76] Inventor: **Vijay S. Malik**, 4405 Fairmount,
Kansas City, Mo. 64111

[**] Term: **14 Years**

[21] Appl. No.: **77,440**

[22] Filed: **Sep. 30, 1997**

Related U.S. Application Data

[62] Division of Ser. No. 69,439, Apr. 16, 1997, Pat. No. Des. 398,787.

[51] **LOC (6) Cl. 06-04**

[52] **U.S. Cl. D6/411; D6/465**

[58] **Field of Search** D6/411, 462, 468,
D6/567; 211/34, 36, 37, 40, 41.4, 43, 41.8,
181.1, 182, 186-189, 191, 134, 153; 206/503,
504, 513; 220/494, 495, 488, 485, 487;
D34/17, 21; 248/176.1

[56] References Cited

U.S. PATENT DOCUMENTS

D. 121,783	8/1940	Castelli et al.	D6/462
D. 309,998	8/1990	Sumrell et al.	D6/567
D. 324,787	3/1992	Evans	D6/411
D. 341,500	11/1993	Klein et al.	D6/411
D. 384,224	9/1997	Dickinson et al.	D6/463
D. 392,817	3/1998	Lee	D6/463
790,669	5/1905	Winship .	
2,276,141	3/1942	Atkinson	211/37
2,431,423	11/1947	Robbins	211/37
2,458,194	1/1949	Panosch	211/34
2,944,676	7/1960	Bell	211/191
3,888,353	6/1975	Leifheit	211/37
4,697,713	10/1987	Pryor	211/189

5,172,816	12/1992	Klein et al.	211/37
5,411,153	5/1995	Unfried	211/188
5,415,297	5/1995	Klein et al.	211/40
5,617,959	4/1997	Klein et al.	211/37
5,678,706	10/1997	Husak et al.	211/189
5,752,610	5/1998	Remmers	211/181.1

Primary Examiner—James Gandy
Assistant Examiner—Linda Brooks
Attorney, Agent, or Firm—Richard L. Marsh

[57] CLAIM

The ornamental design for a modular storage rack for shoes, as shown and described.

DESCRIPTION

FIG. 1 is a front elevation of the modular storage rack for shoes, showing the telescoping tubes in extended position, with the rear view being a mirror image;
FIG. 2 is a top view thereof;
FIG. 3 is a bottom view thereof;
FIG. 4 is a greatly enlarged right hand view thereof;
FIG. 5 is an enlarged rear perspective view thereof shown in partial exploded view for clarity, with the telescoping tubes in fully retracted position;
FIG. 6 is a greatly enlarged left hand elevation view of one of the ends of the frame of the modular storage rack for shoes of FIG. 1, shown separately for clarity of illustration and having two sets of sockets for receiving support tubes therein; and,
FIG. 7 is a greatly enlarged right hand elevation view of the opposite end of the frame of FIG. 6.
The broken line structure shown in FIGS. 1, 2 and 3 is for illustrative purposes only and forms no part of the claimed design.

1 Claim, 5 Drawing Sheets

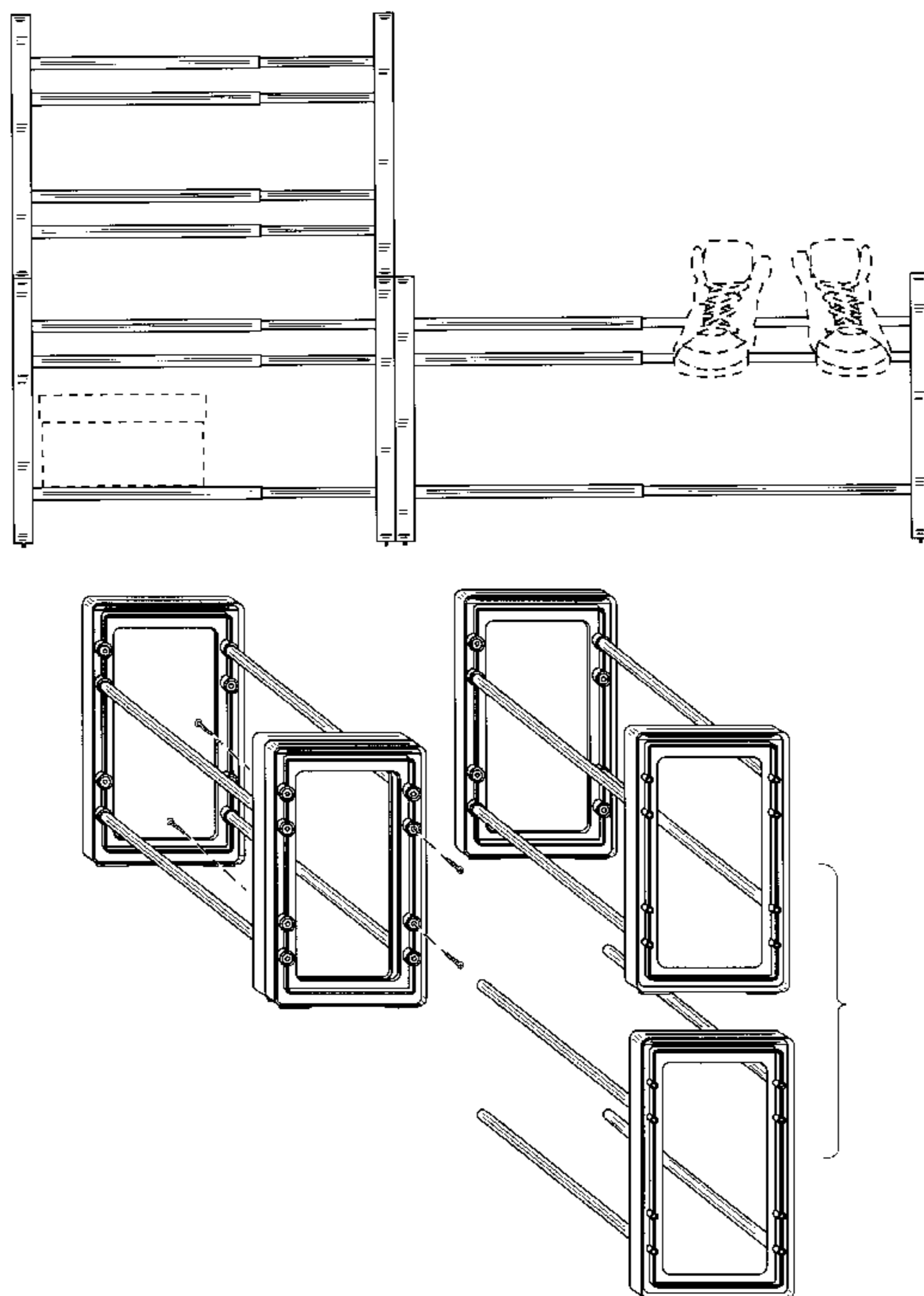

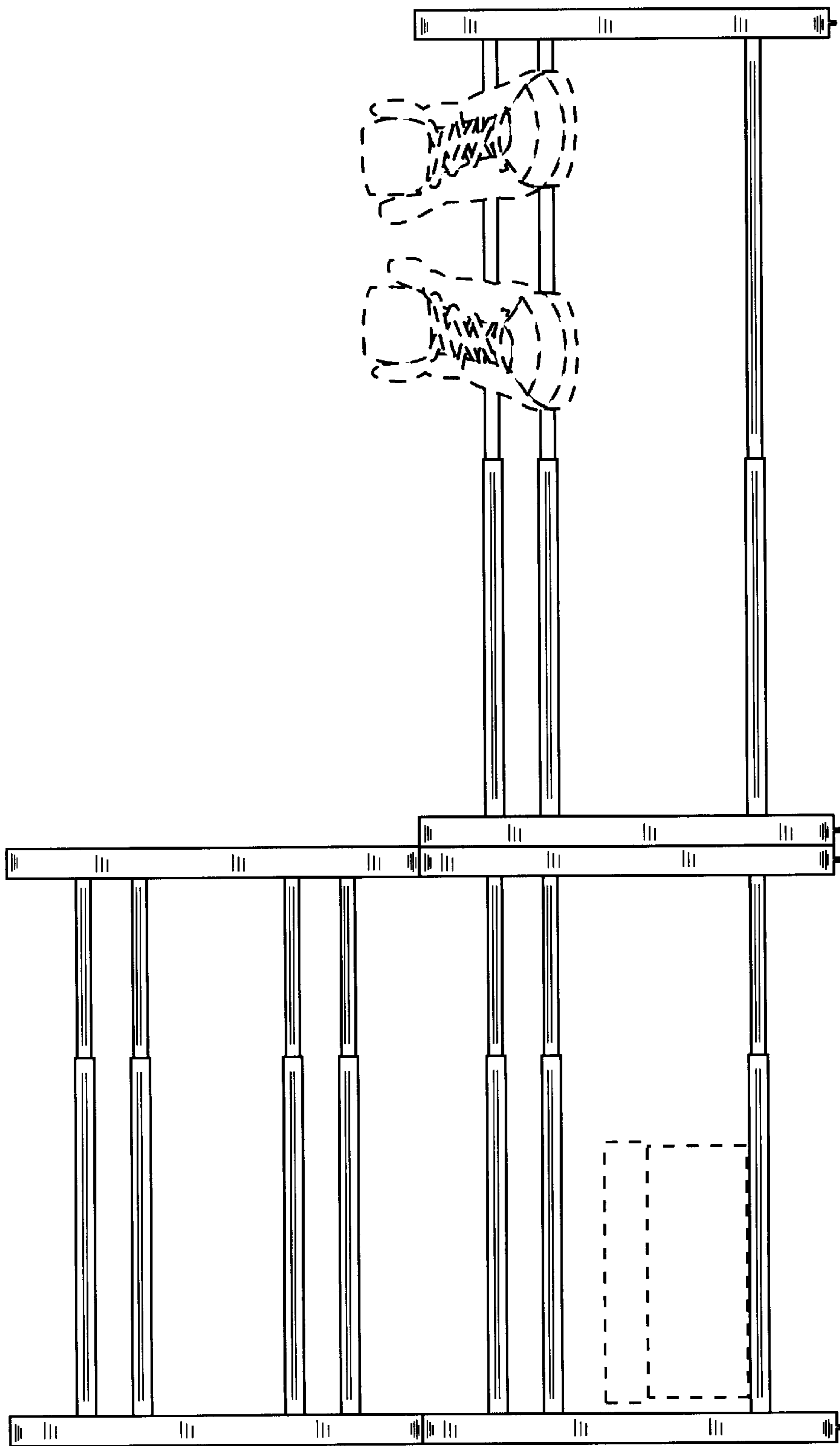

FIG. 1

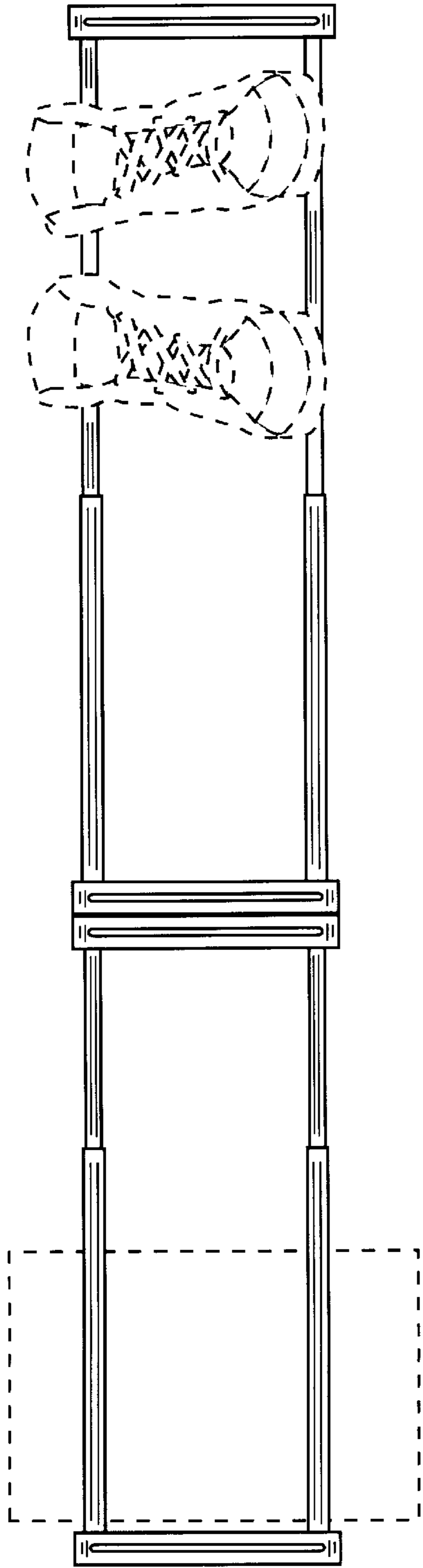

FIG. 2

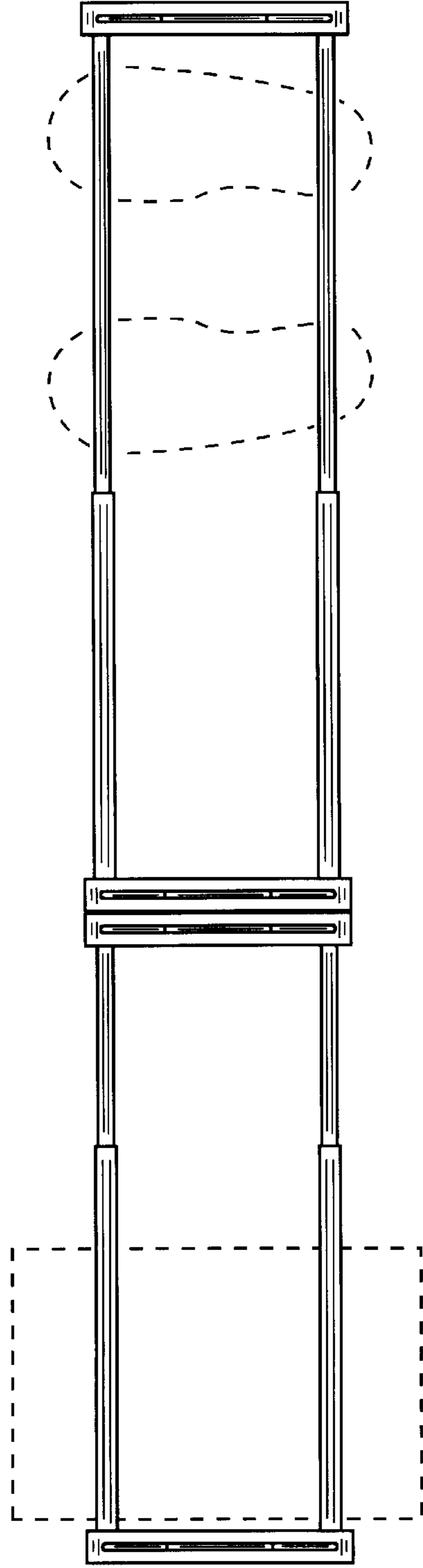

FIG. 3

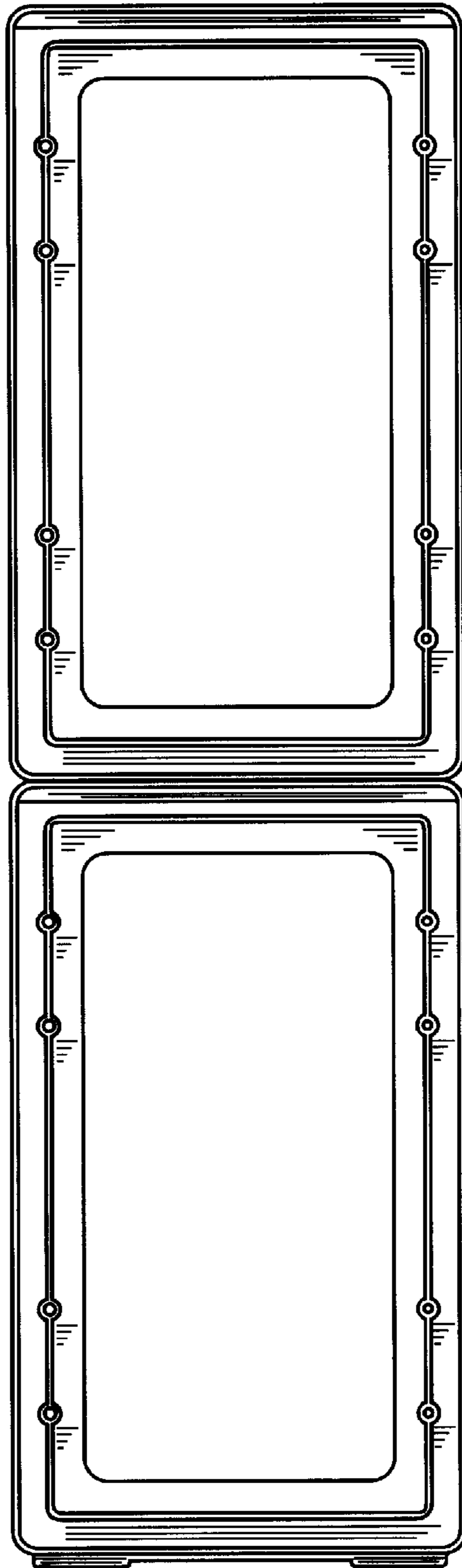

FIG. 4

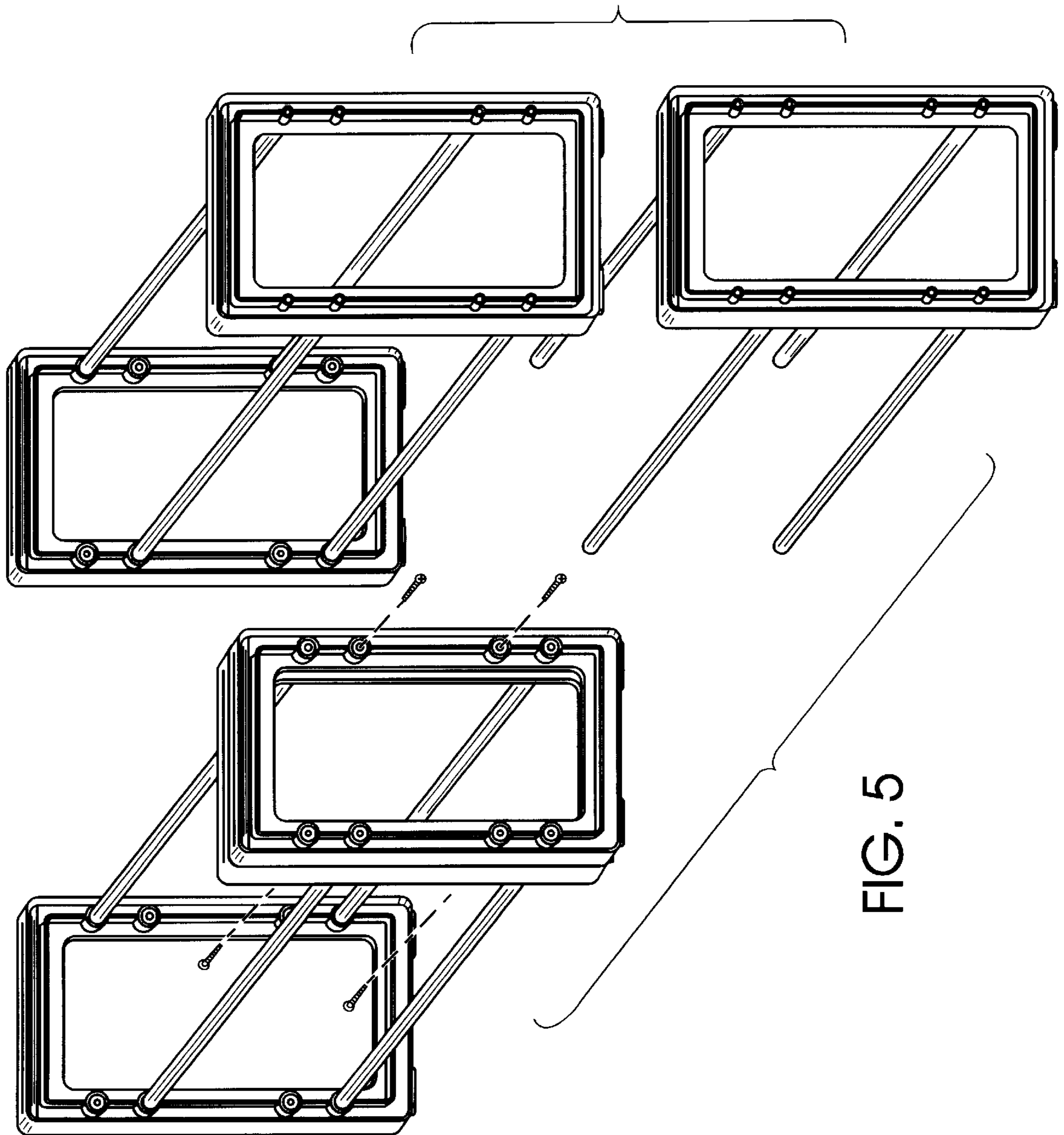

FIG. 5

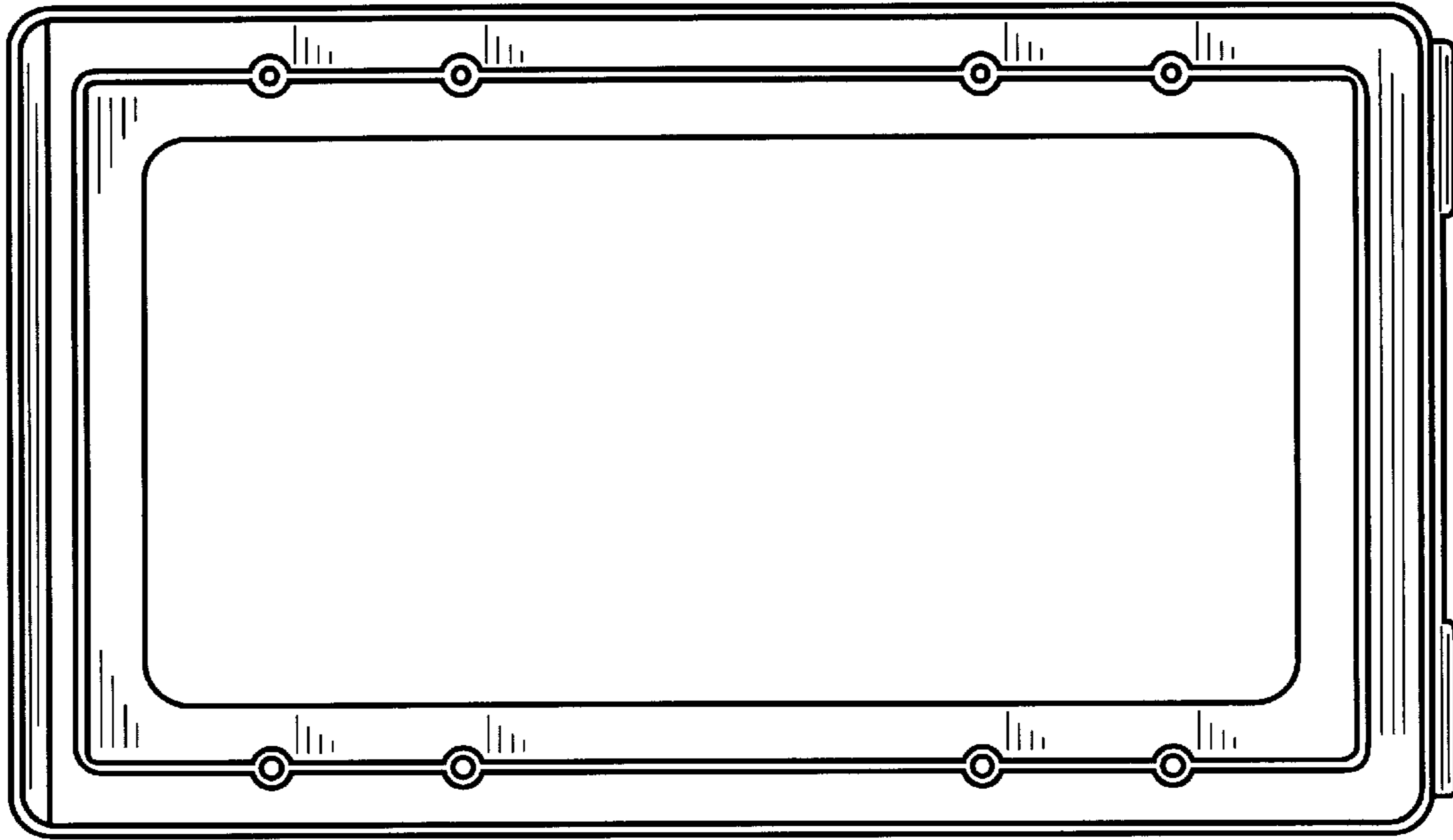

FIG. 7

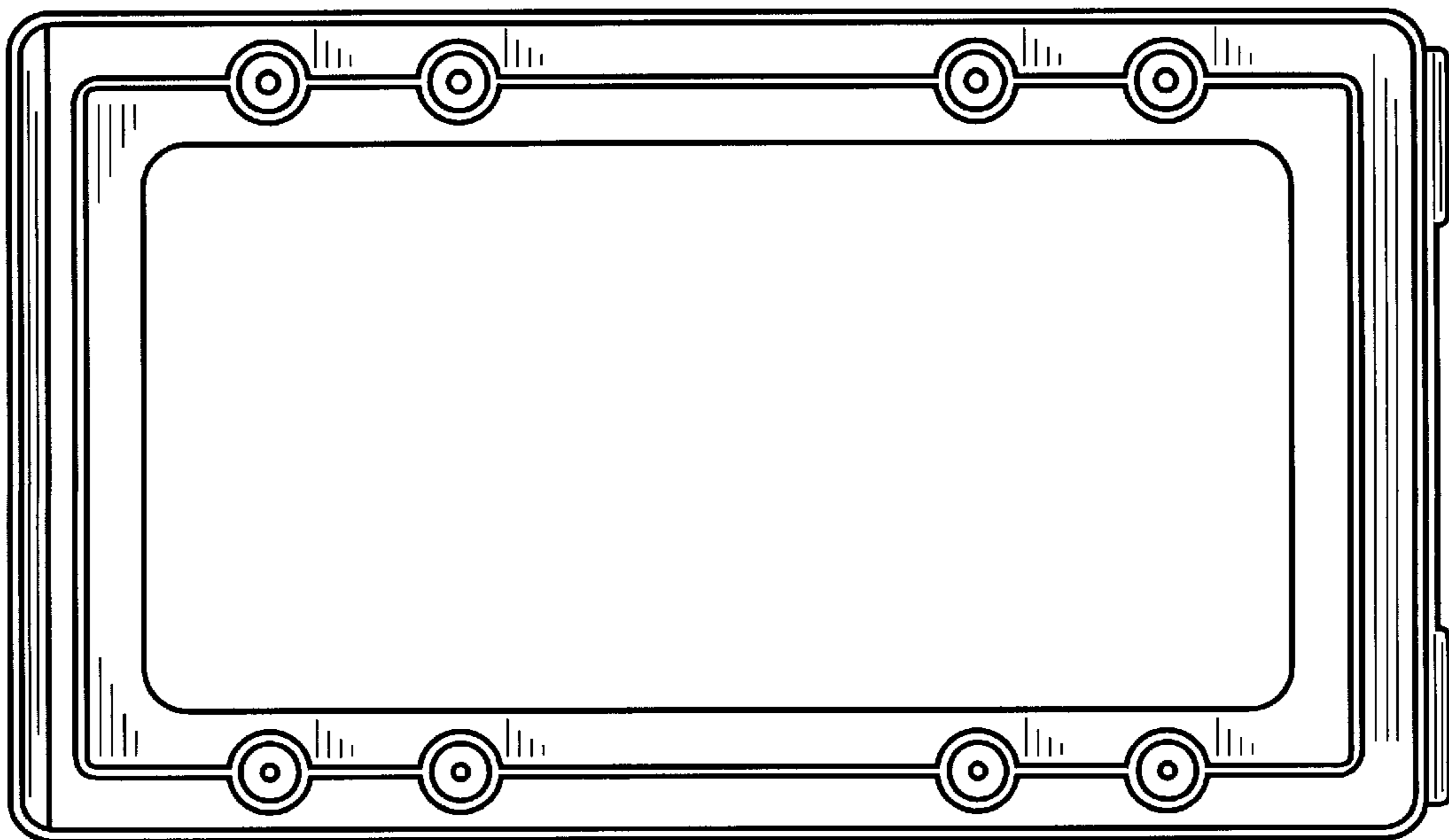

FIG. 6