



US00D403792S

**United States Patent** [19]  
**Von Kluck**

[11] **Patent Number:** **Des. 403,792**  
[45] **Date of Patent:** **\*\*Jan. 5, 1999**

[54] **OUTDOOR LIGHTING FIXTURE**

[75] Inventor: **Kevin Von Kluck**, Hudson, Ohio  
[73] Assignee: **The L.D. Kichler Co.**, Cleveland, Ohio  
[\*\*] Term: **14 Years**  
[21] Appl. No.: **76,880**  
[22] Filed: **Sep. 24, 1997**

[51] **LOC (6) Cl.** ..... **26-05**  
[52] **U.S. Cl.** ..... **D26/71; D26/101**  
[58] **Field of Search** ..... **D26/67, 68, 72,**  
**D26/85, 87, 92, 73, 101; 362/147, 432,**  
**367, 431, 806; D25/53**

[56] **References Cited**

**U.S. PATENT DOCUMENTS**

D. 193,157 7/1962 O'Donoghuy et al. .... D25/53  
D. 385,376 10/1997 Milicia ..... D26/73  
D. 385,377 10/1997 Kay ..... D26/73

**OTHER PUBLICATIONS**

Home Lighting and Accessories, p. 58, Thomas Industries wall lantern, Mar. 1995.  
Home Lighting and Accessories, p. 58, Focus Industries post lamp, Mar. 1996.

*Primary Examiner*—Susan J. Lucas  
*Attorney, Agent, or Firm*—Watts, Hoffmann, Fisher & Heinke, Co., L.P.A.

[57] **CLAIM**

I claim the ornamental design for an outdoor lighting fixture, as shown and described.

**DESCRIPTION**

FIG. 1 is a perspective view of an outdoor lighting fixture showing my new design;  
FIG. 2 is a front elevational view of the outdoor lighting fixture;  
FIG. 3 is a right side elevational view of the outdoor lighting fixture, the left side elevational view being a mirror image;  
FIG. 4 is a rear elevational view of the outdoor lighting fixture;  
FIG. 5 is top plan view of the outdoor lighting fixture; and,  
FIG. 6 is a bottom plan view of the outdoor lighting fixture.

**1 Claim, 4 Drawing Sheets**

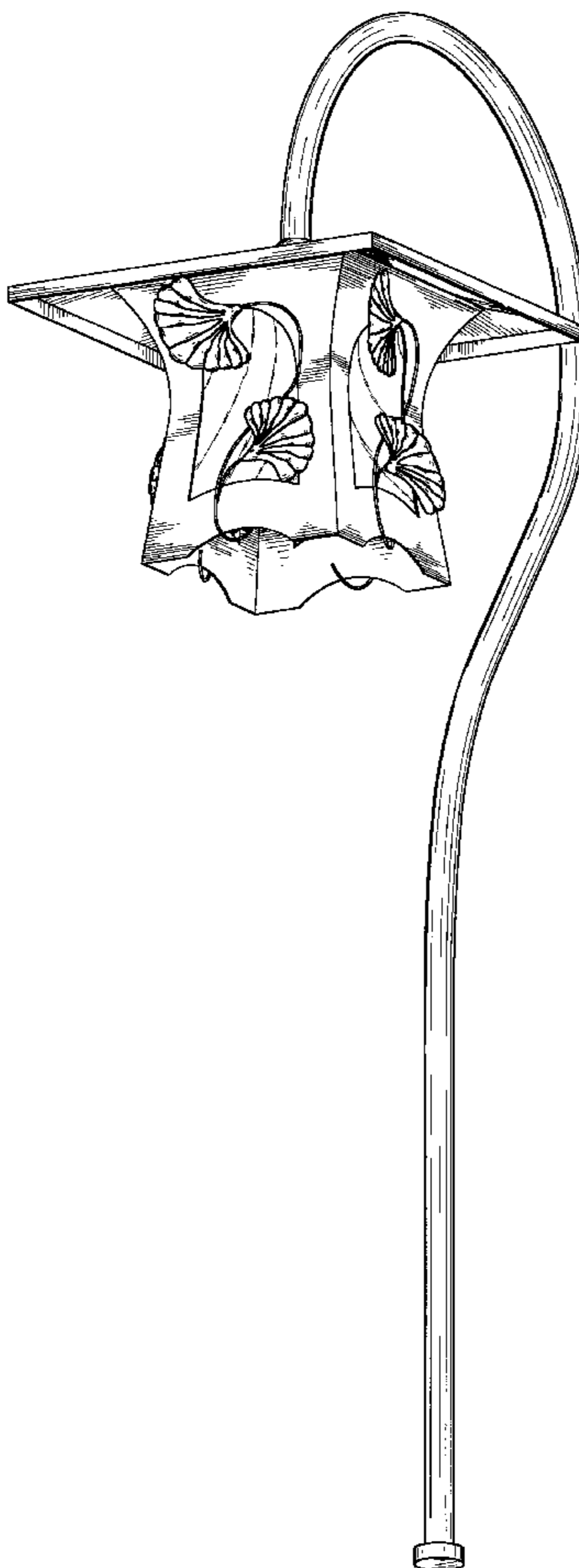

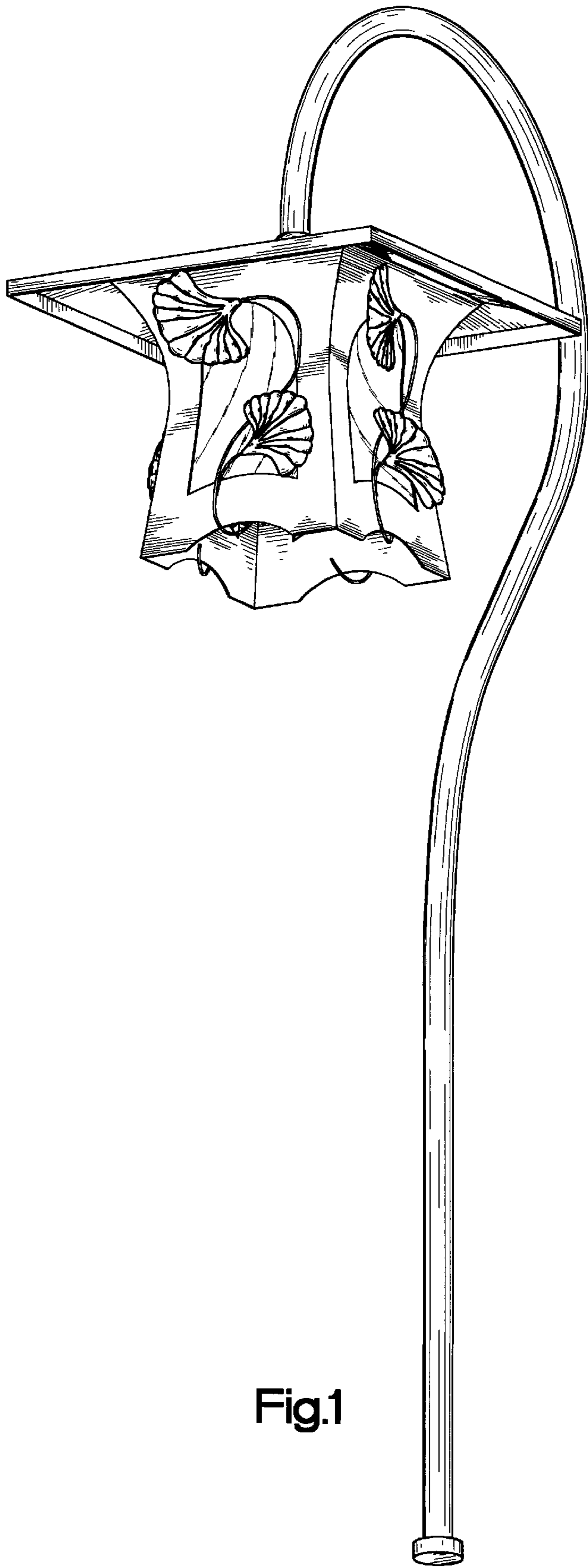

Fig.1

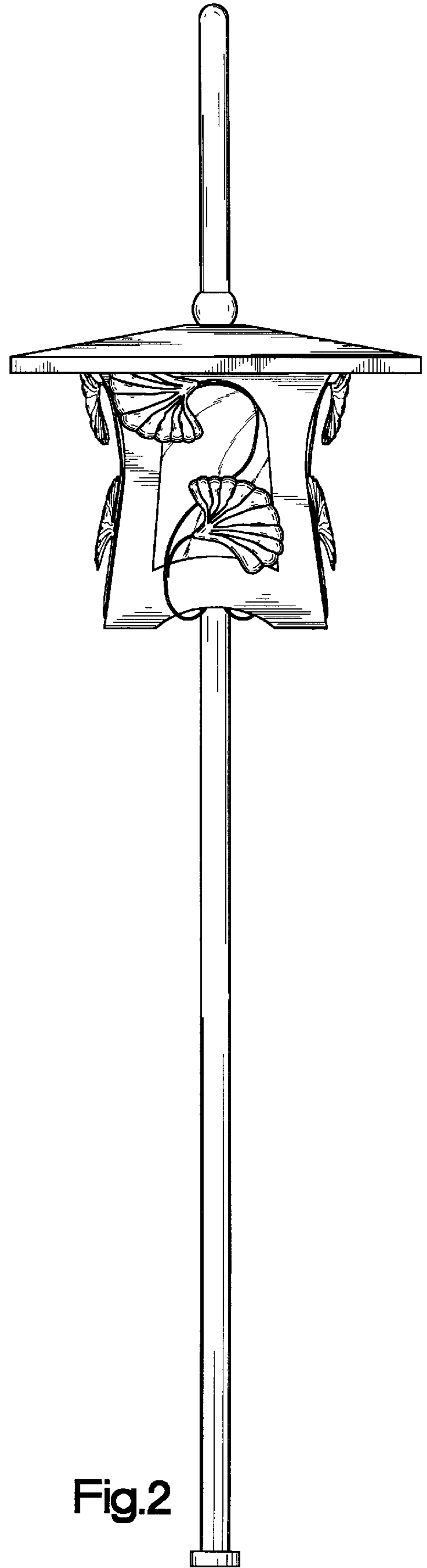
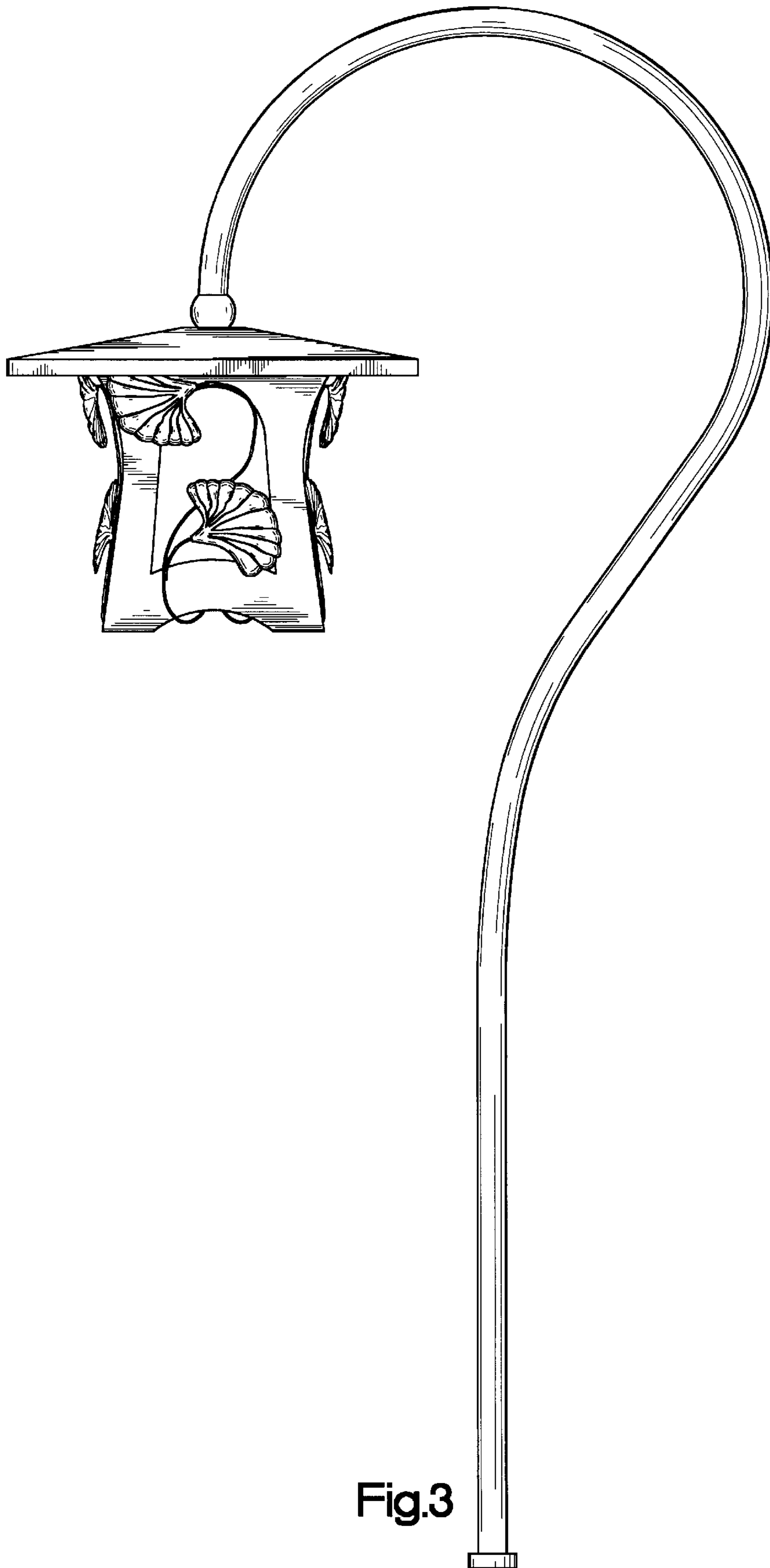

Fig.2



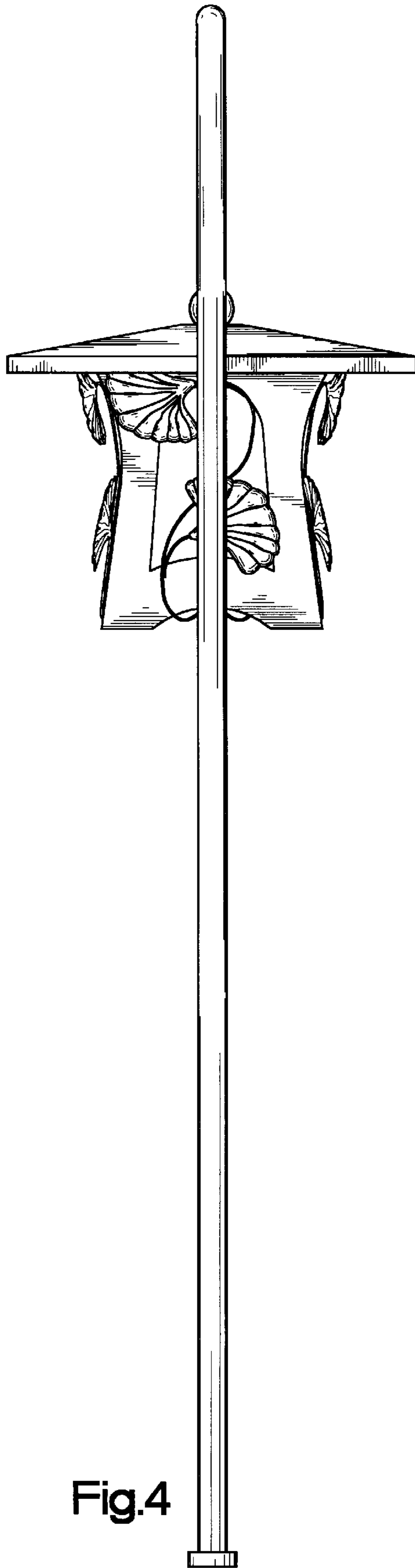

Fig.4

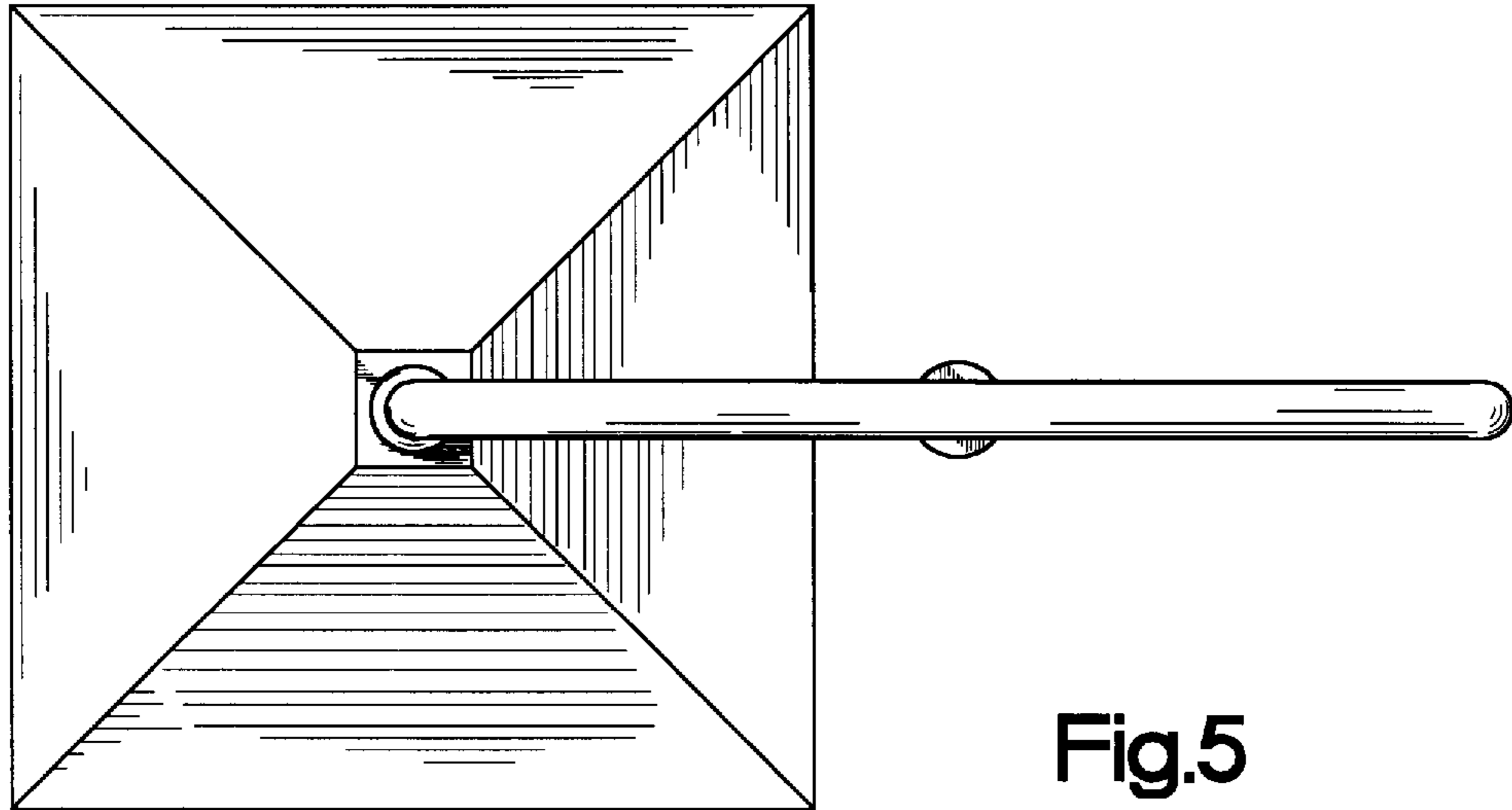

Fig.5

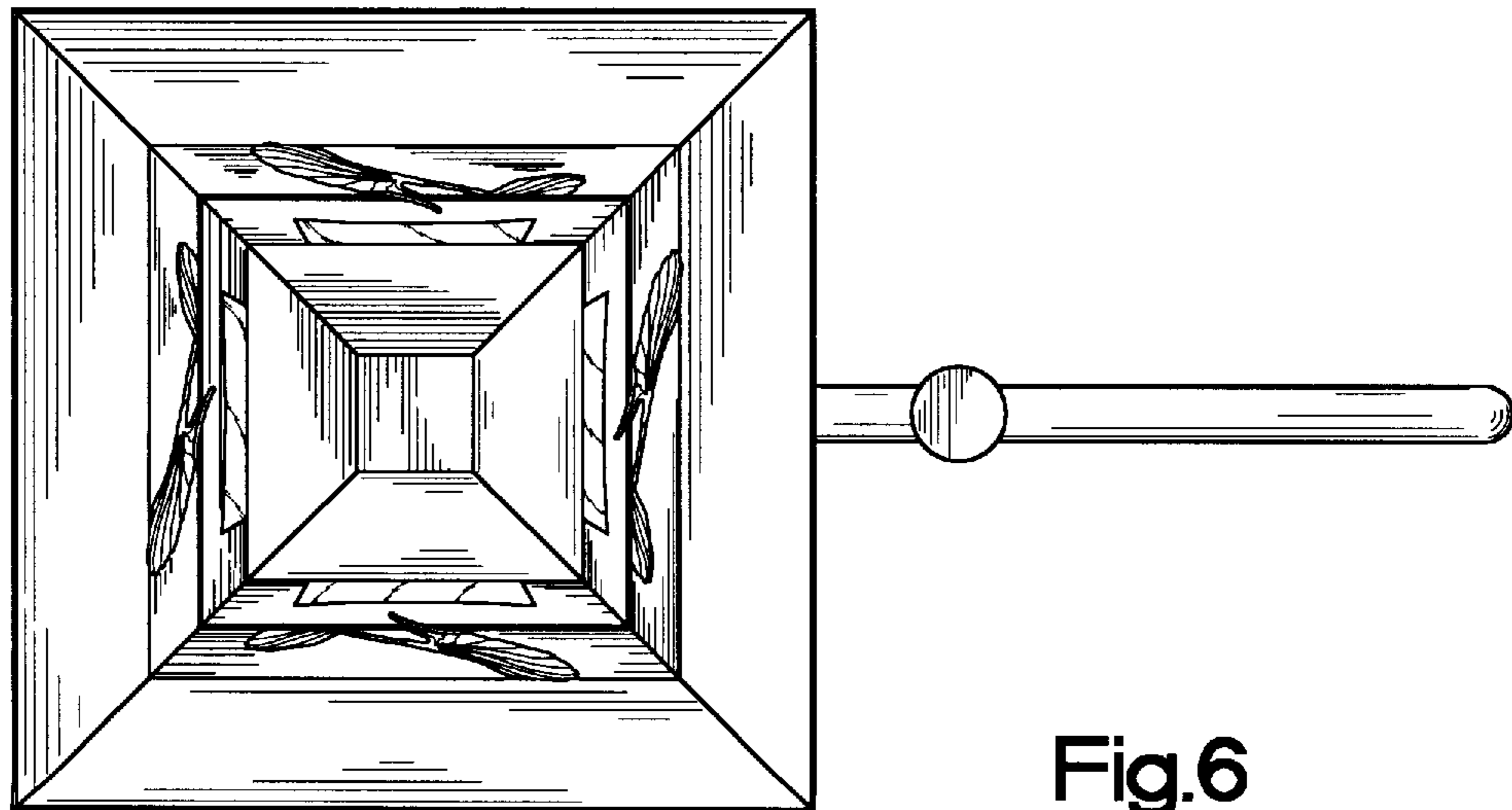

Fig.6