



US00D403750S

**United States Patent** [19]  
**Fabian**

[11] **Patent Number: Des. 403,750**  
[45] **Date of Patent: \*\*Jan. 5, 1999**

[54] **ESCUTCHEON PLATE FOR A SHOWER CONTROL**

[75] Inventor: **Wolfgang Fabian**, Mannheim, Germany

[73] Assignee: **American Standard, Inc.**, Piscataway, N.J.

[\*\*] Term: **14 Years**

[21] Appl. No.: **60,364**

[22] Filed: **Sep. 27, 1996**

[51] **LOC (6) Cl.** ..... **23-01**

[52] **U.S. Cl.** ..... **D23/254; D8/352**

[58] **Field of Search** ..... D23/213, 223,  
D23/228, 549; D8/352, 350; 4/675-678;  
292/357; 137/801

[56] **References Cited**

**U.S. PATENT DOCUMENTS**

D. 68,807	11/1925	Hill	.....	D8/352
D. 164,606	9/1951	Schloge	.....	D8/352
D. 191,594	10/1961	Clayton	.....	D8/352
D. 201,096	5/1965	Russell	.....	D8/352
D. 202,029	8/1965	Blum et al.	.....	D8/352

D. 203,795	2/1966	Horney et al.	.....	D23/254
D. 212,029	8/1968	Algoren	.....	D8/352
D. 288,525	3/1987	Angle	.....	D8/352 X
D. 310,324	9/1990	Bernocchi et al.	.....	D8/399
D. 321,468	11/1991	Reid	.....	D8/352
D. 345,004	3/1994	Bengtson	.....	D23/254
D. 355,021	1/1995	Schott et al.	.....	D23/254
D. 373,180	8/1996	Gottwold	.....	D23/254

*Primary Examiner*—Louis S. Zarfaz  
*Assistant Examiner*—Eric M. Watterson

[57] **CLAIM**

The ornamental design for an escutcheon plate for a shower control, as shown and described.

**DESCRIPTION**

FIG. 1 is a perspective view of an escutcheon plate for a shower control showing my new design; FIG. 2 is a right side elevational view thereof, the left side view being a mirror image of the right side; FIG. 3 is a front elevational view thereof; FIG. 4 is a rear elevational view thereof; FIG. 5 is a top plan view thereof; and, FIG. 6 is a bottom plan view thereof.

**1 Claim, 1 Drawing Sheet**

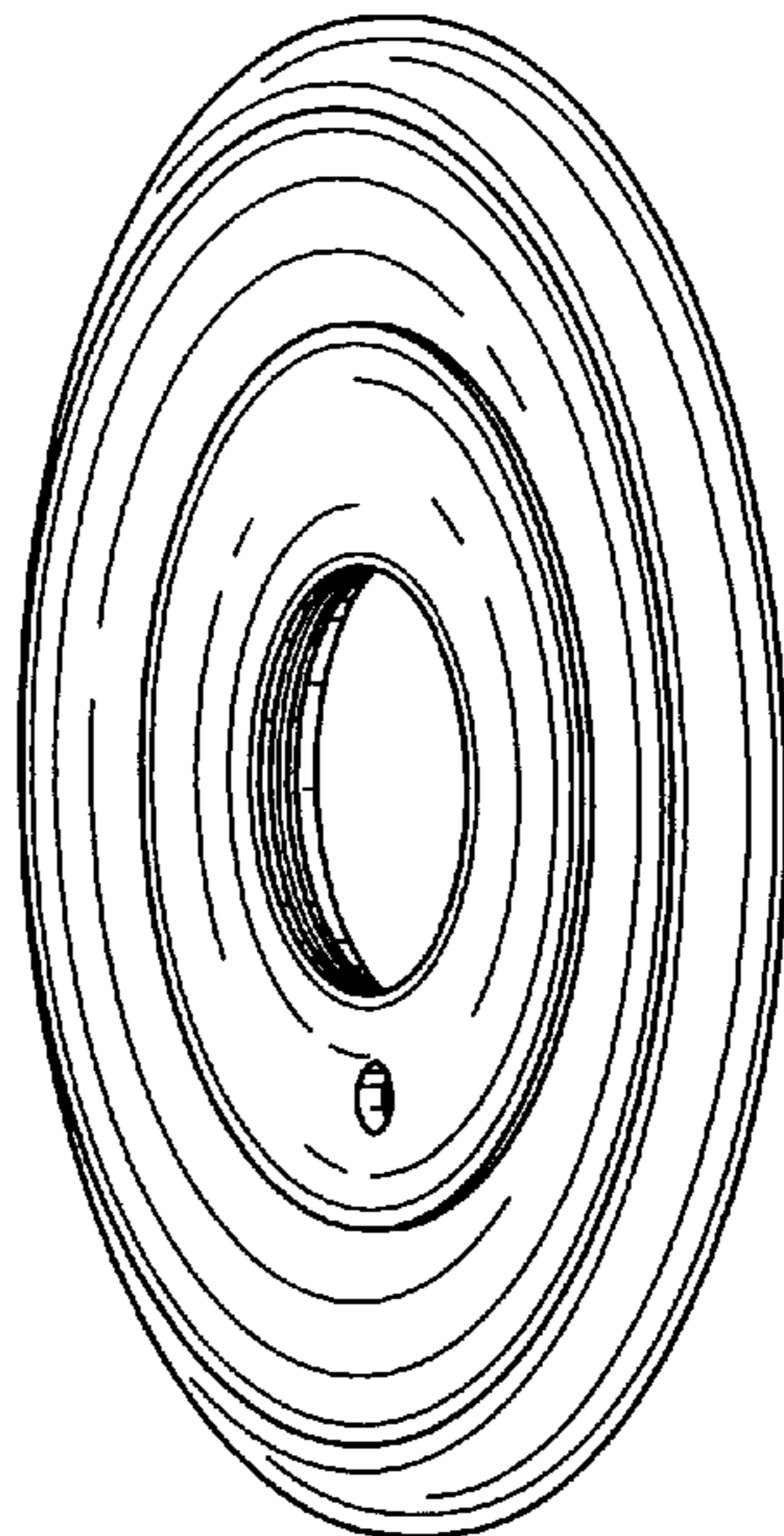

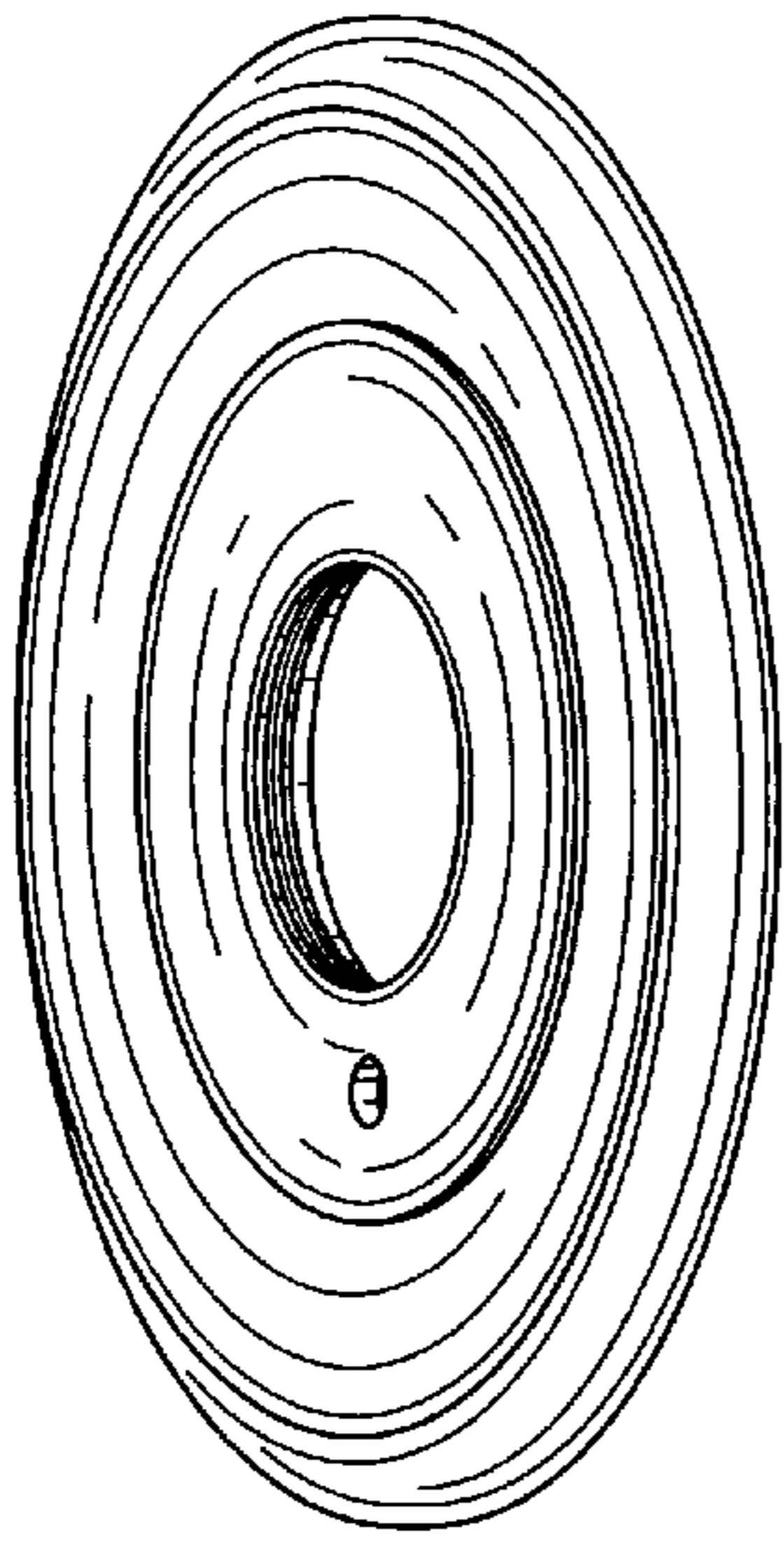

FIG. 1

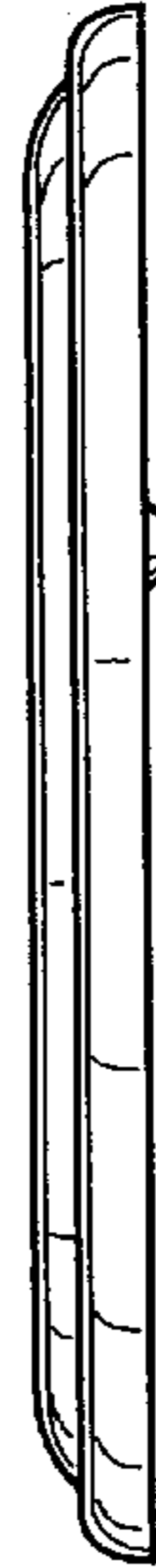

FIG. 2

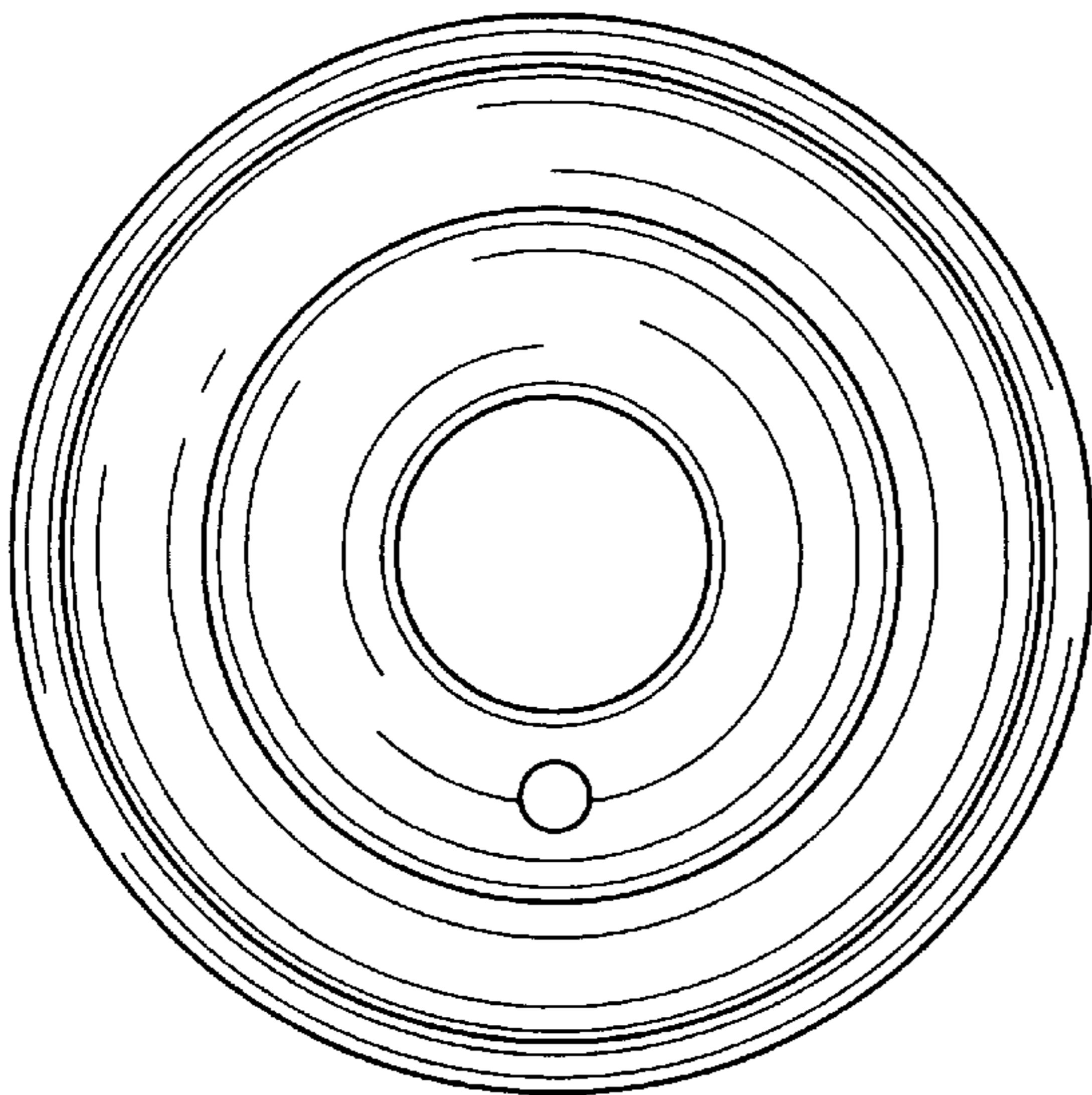

FIG. 3

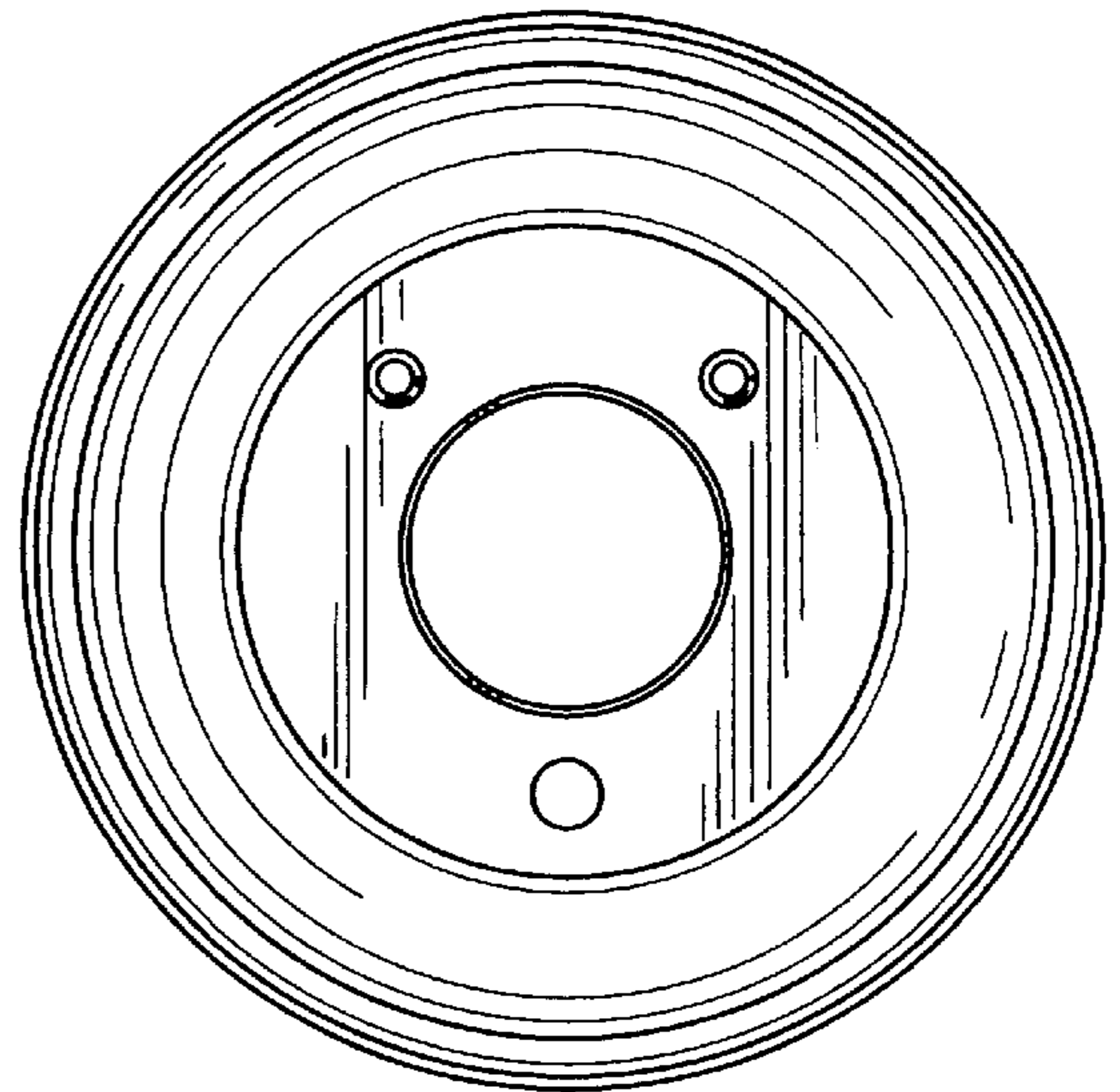

FIG. 4

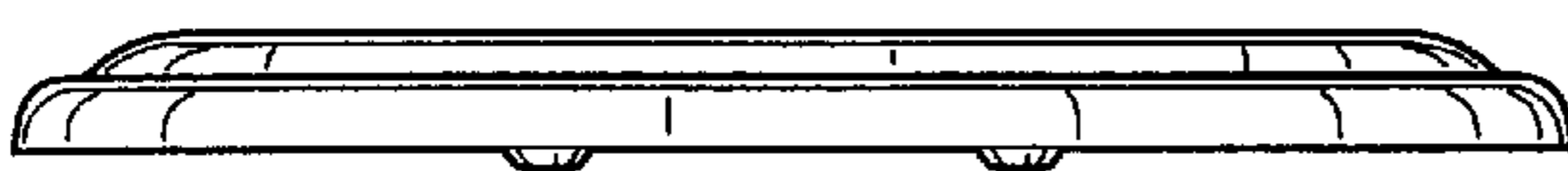

FIG. 5

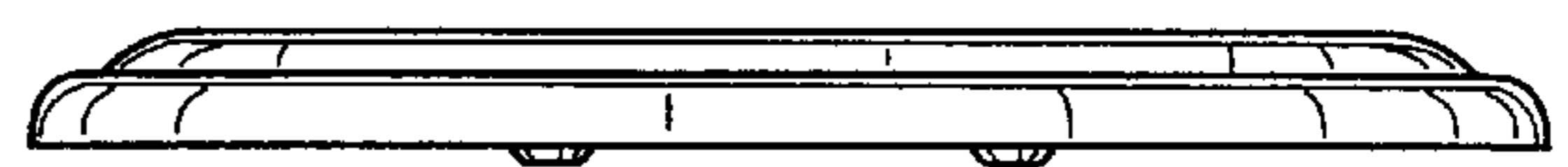

FIG. 6