



US00D403719S

United States Patent [19]

Smith, II et al.

[11] Patent Number: **Des. 403,719**

[45] Date of Patent: ****Jan. 5, 1999**

[54] **INFANT BATH TOY**

[75] Inventors: **Donald A. Smith, II**, Harrisville;
Celeste T. Penacho, Cumberland, both
of R.I.

[73] Assignee: **Summer Infant Products, Inc.**,
Cumberland, R.I.

[**] Term: **14 Years**

[21] Appl. No.: **82,698**

[22] Filed: **Nov. 25, 1997**

[51] **LOC (6) Cl.** **21-01**

[52] **U.S. Cl.** **D21/476; D21/398**

[58] **Field of Search** **D21/398, 405,**
D21/475, 476; 446/227, 228

[56] **References Cited**

U.S. PATENT DOCUMENTS

- D. 175,592 9/1955 Dixon D21/476
- D. 182,154 2/1958 Allen D21/476
- D. 281,438 11/1985 Wong D21/476

- D. 288,829 3/1987 Cheuk-Sun D21/476
- D. 295,198 4/1988 Williams et al. D21/476
- 355,663 1/1887 Price 446/227
- D. 374,692 10/1996 Stroud et al. D21/476
- D. 387,814 12/1997 Chow et al. D21/475
- 2,402,861 6/1946 Winnick 446/227

Primary Examiner—Dominic Simone
Attorney, Agent, or Firm—John E. Reilly

[57] **CLAIM**

The ornamental design for an infant bath toy, as shown and described.

DESCRIPTION

FIG. 1 is a perspective view showing our new design; FIG. 2 is a front view in elevation thereof; FIG. 3 is a side view in elevation thereof; FIG. 4 is a bottom plan view thereof; FIG. 5 is a top plan view thereof; FIG. 6 is rear view in elevation thereof; and, FIG. 7 is a side view taken from a side opposite to that of FIG. 3 thereof.

1 Claim, 2 Drawing Sheets

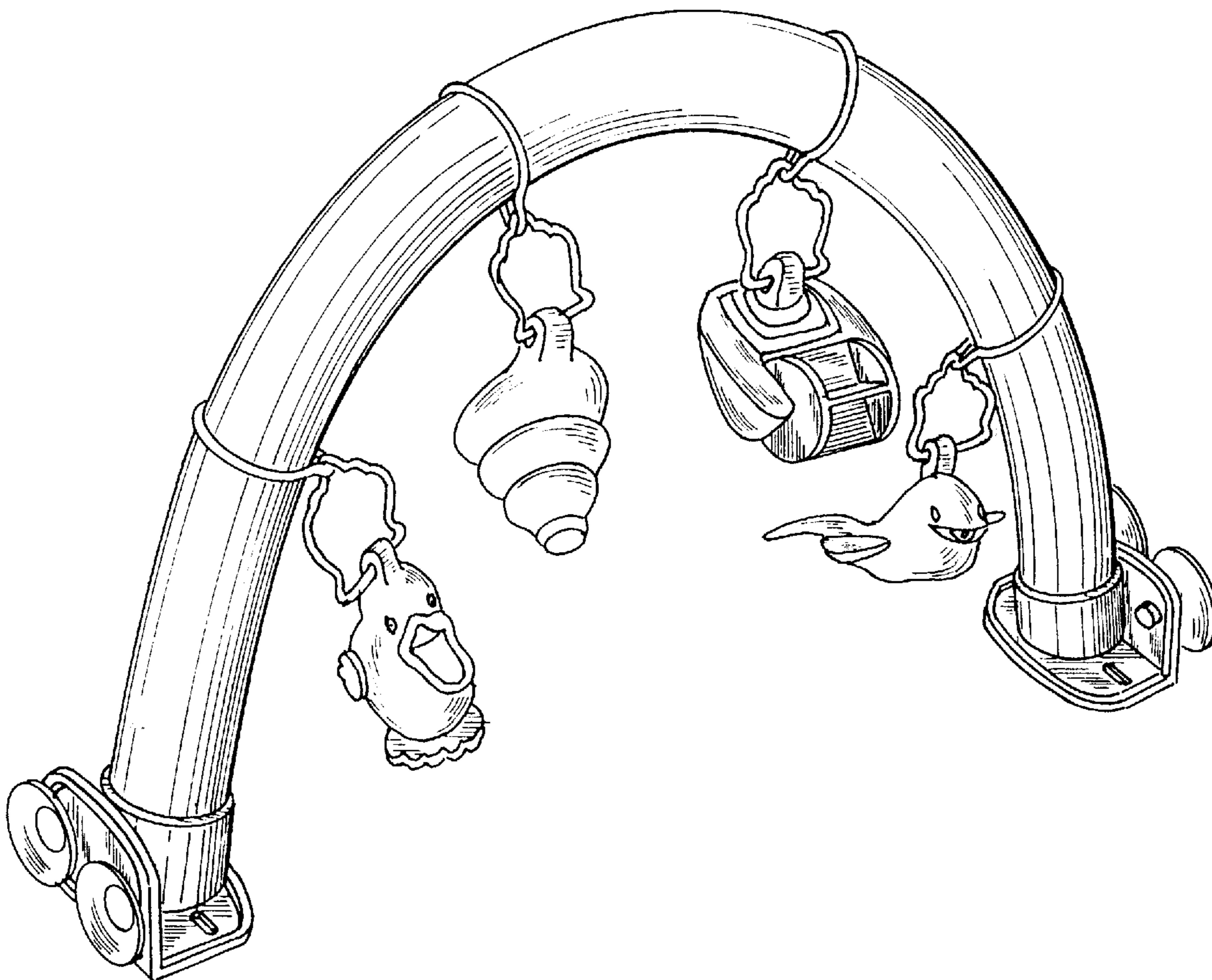

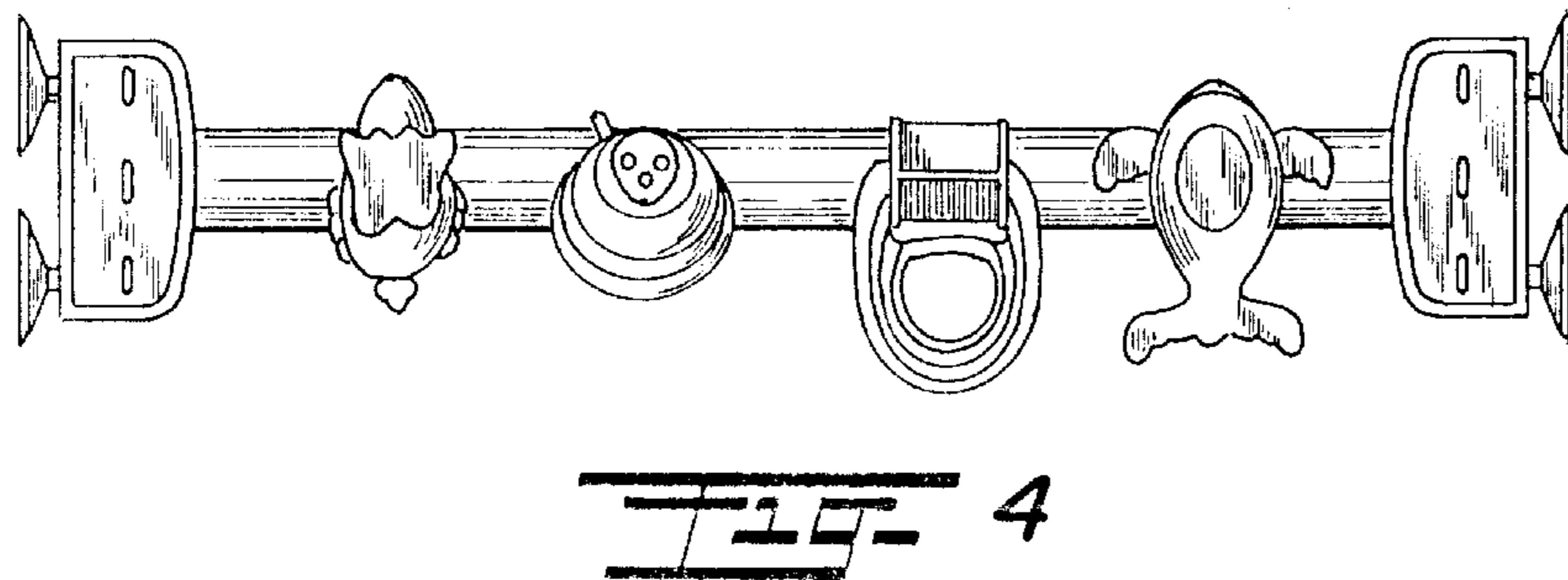
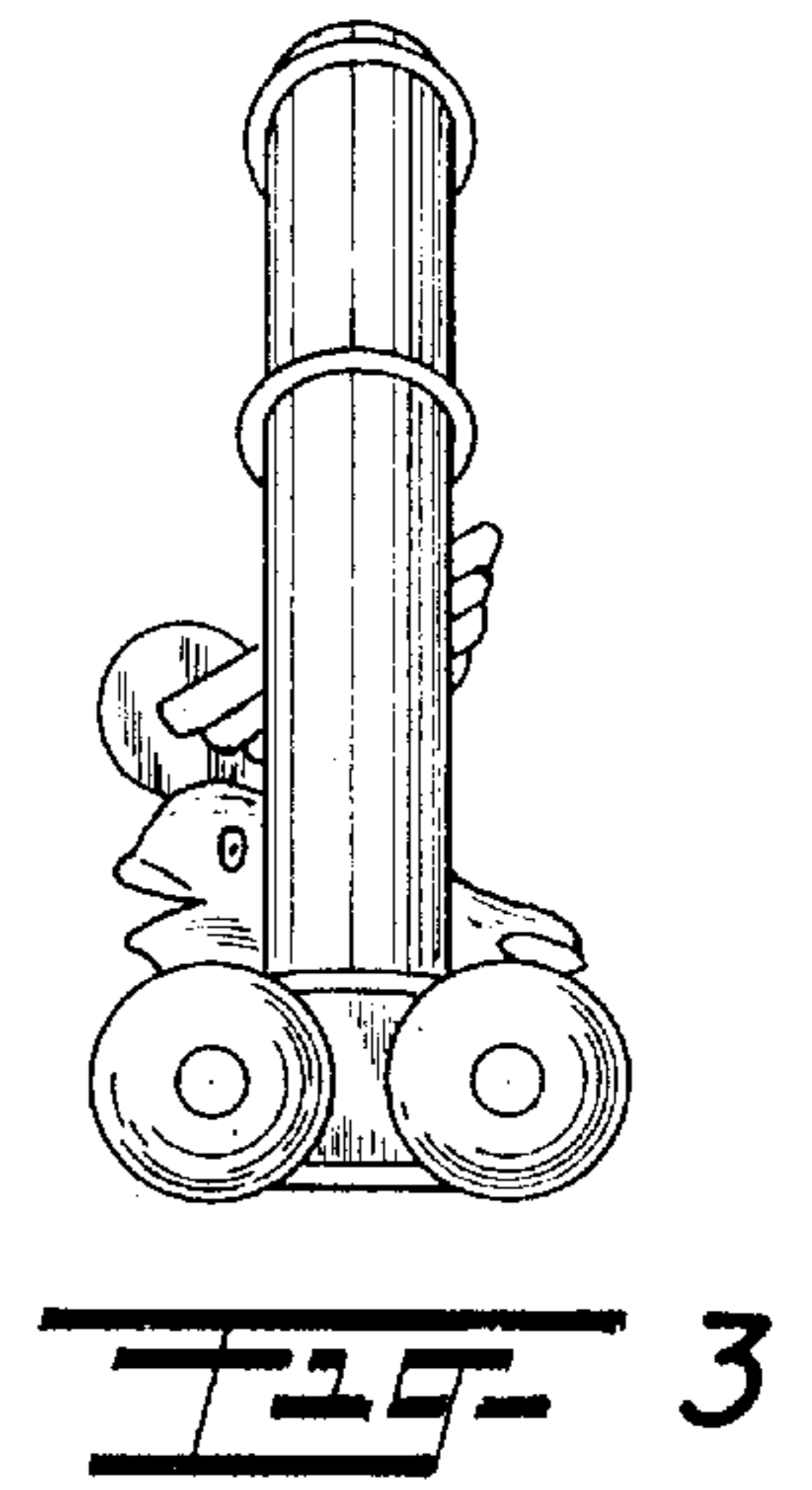
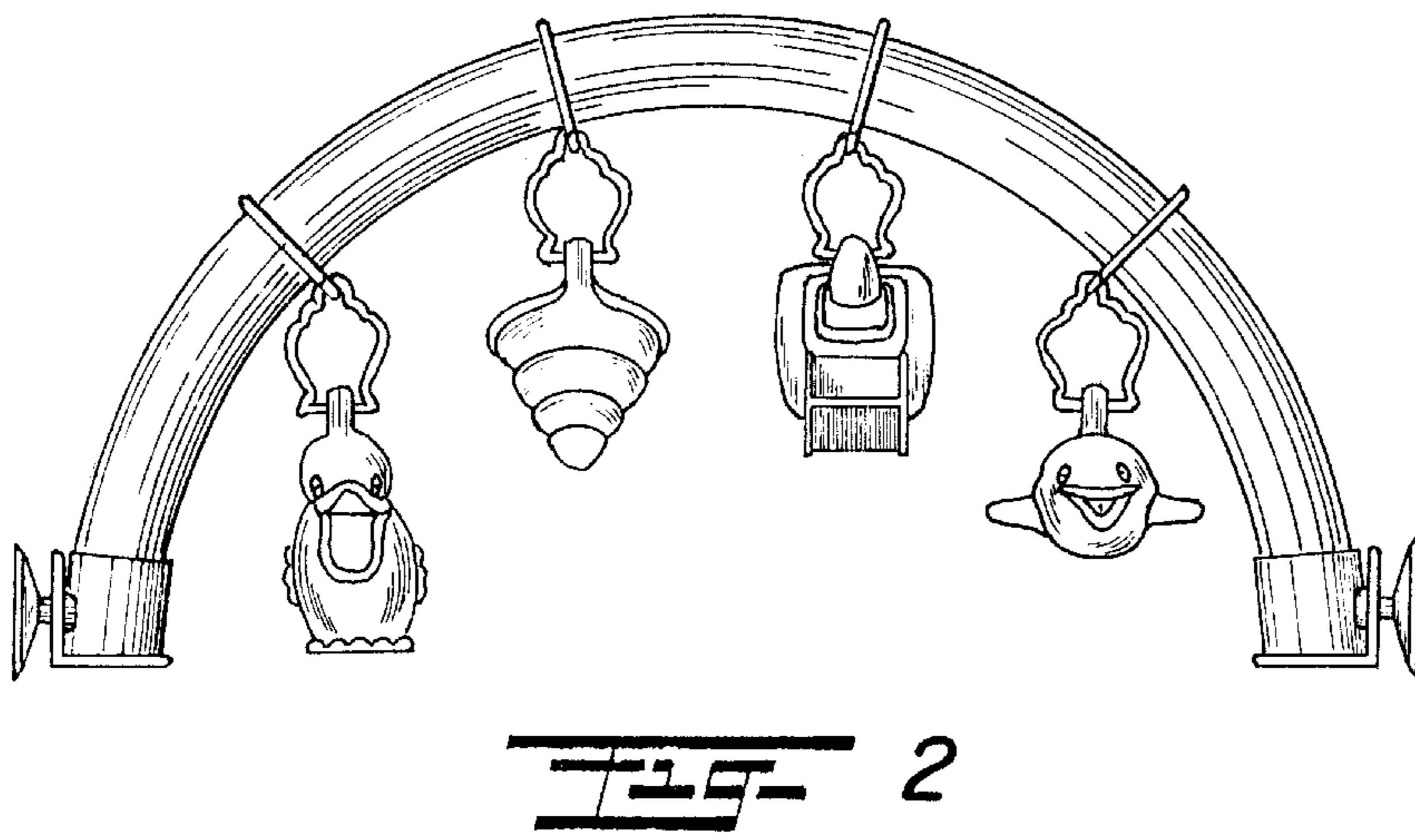
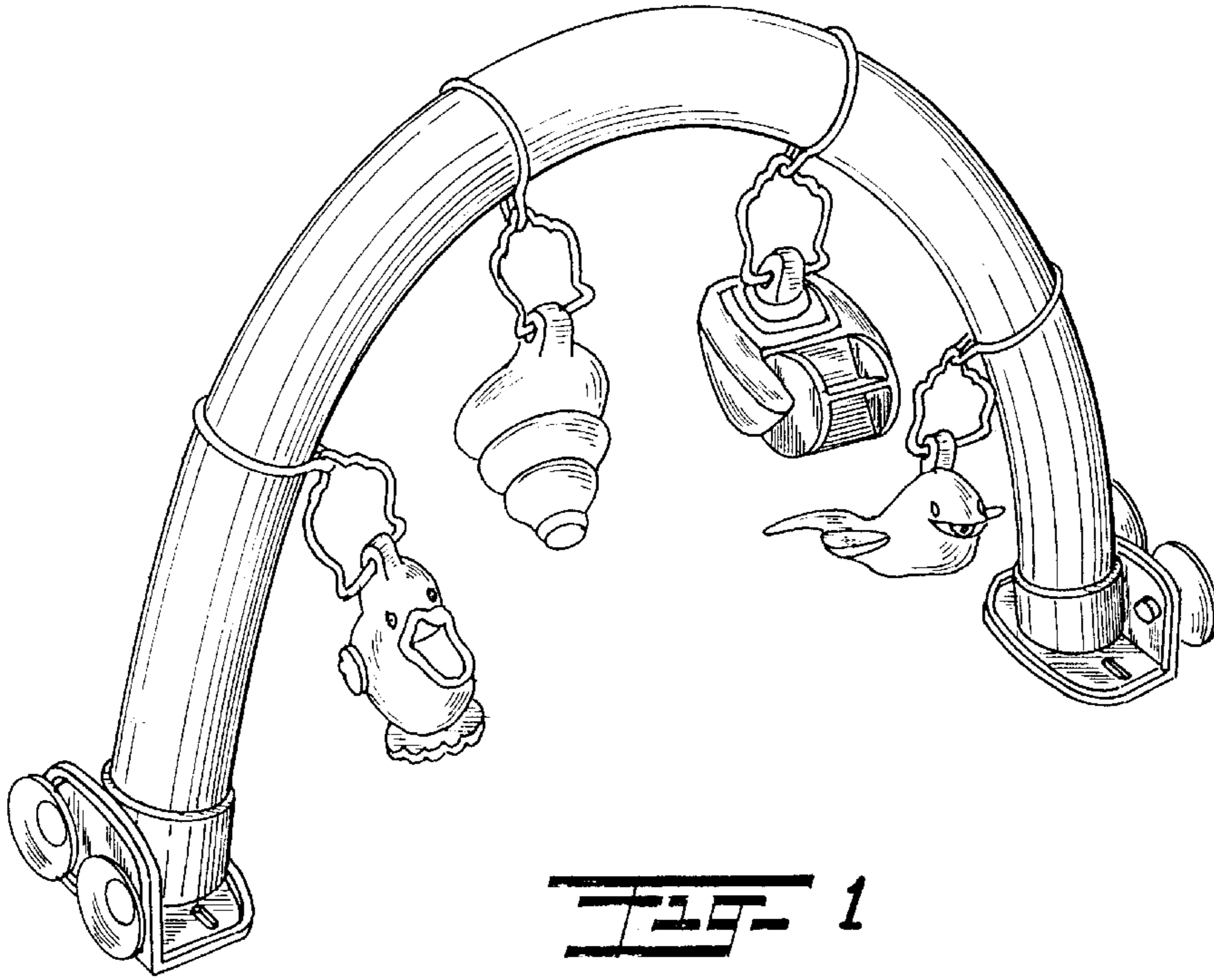

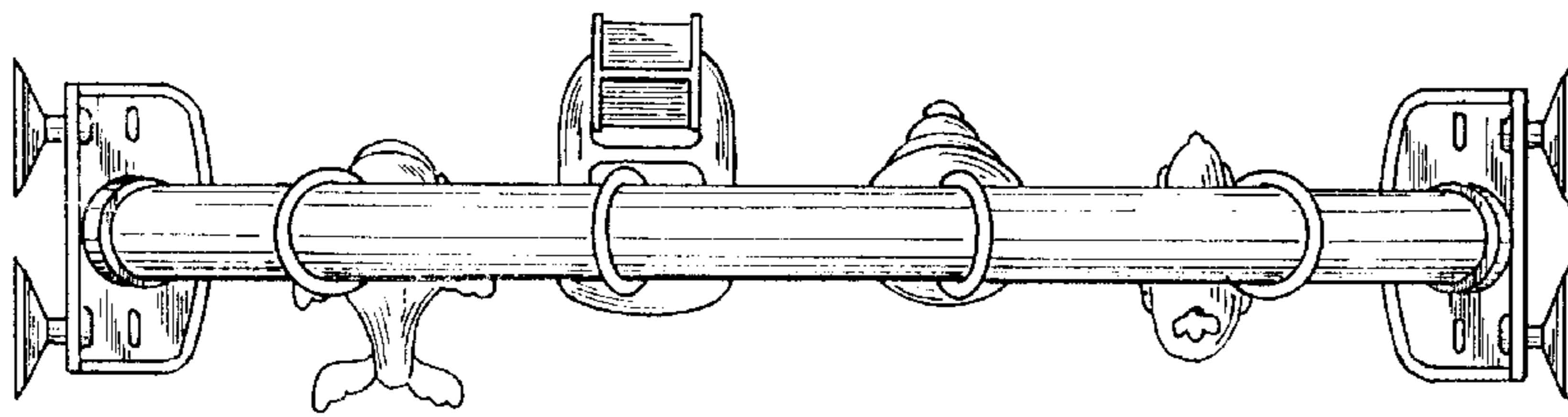

FIG. 5

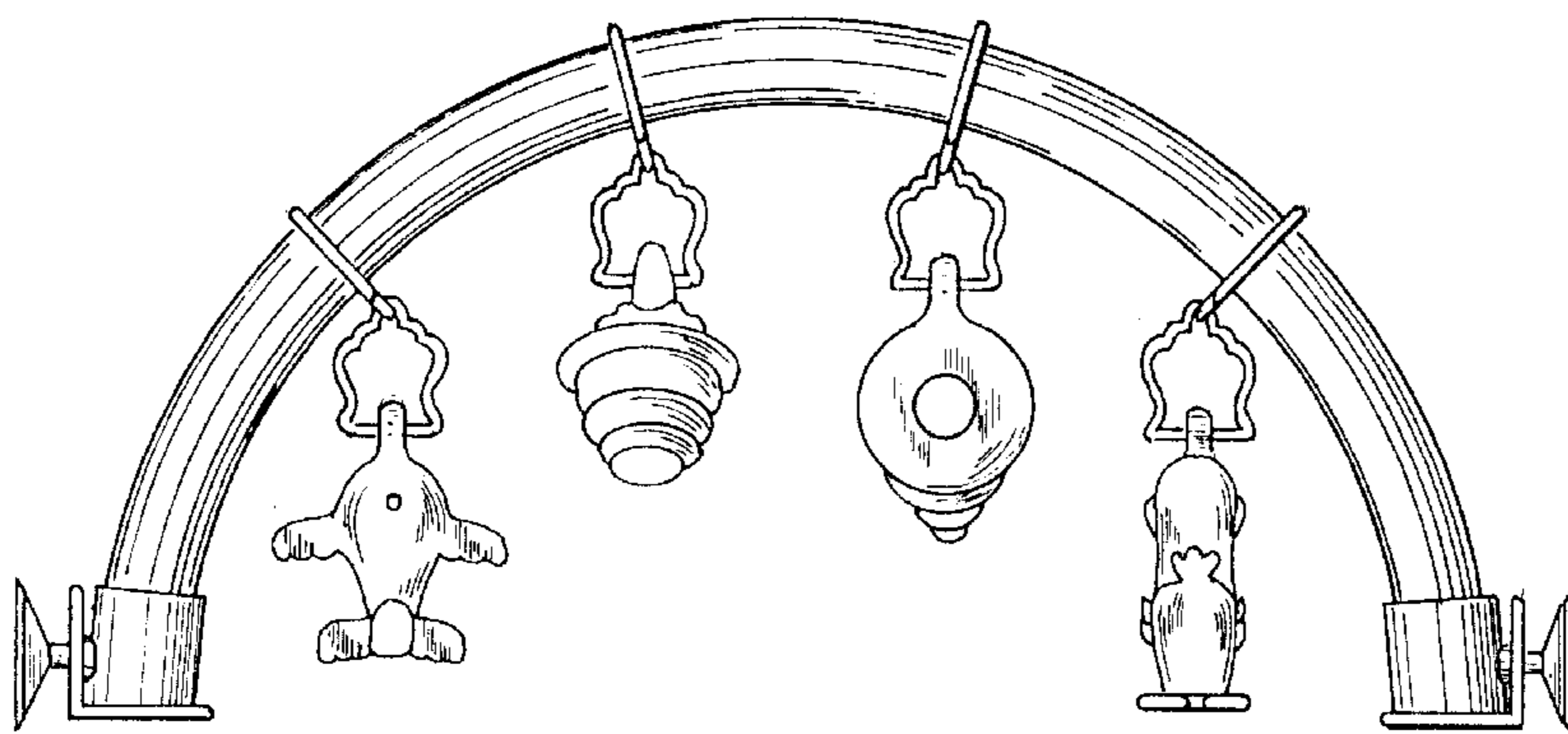

FIG. 6

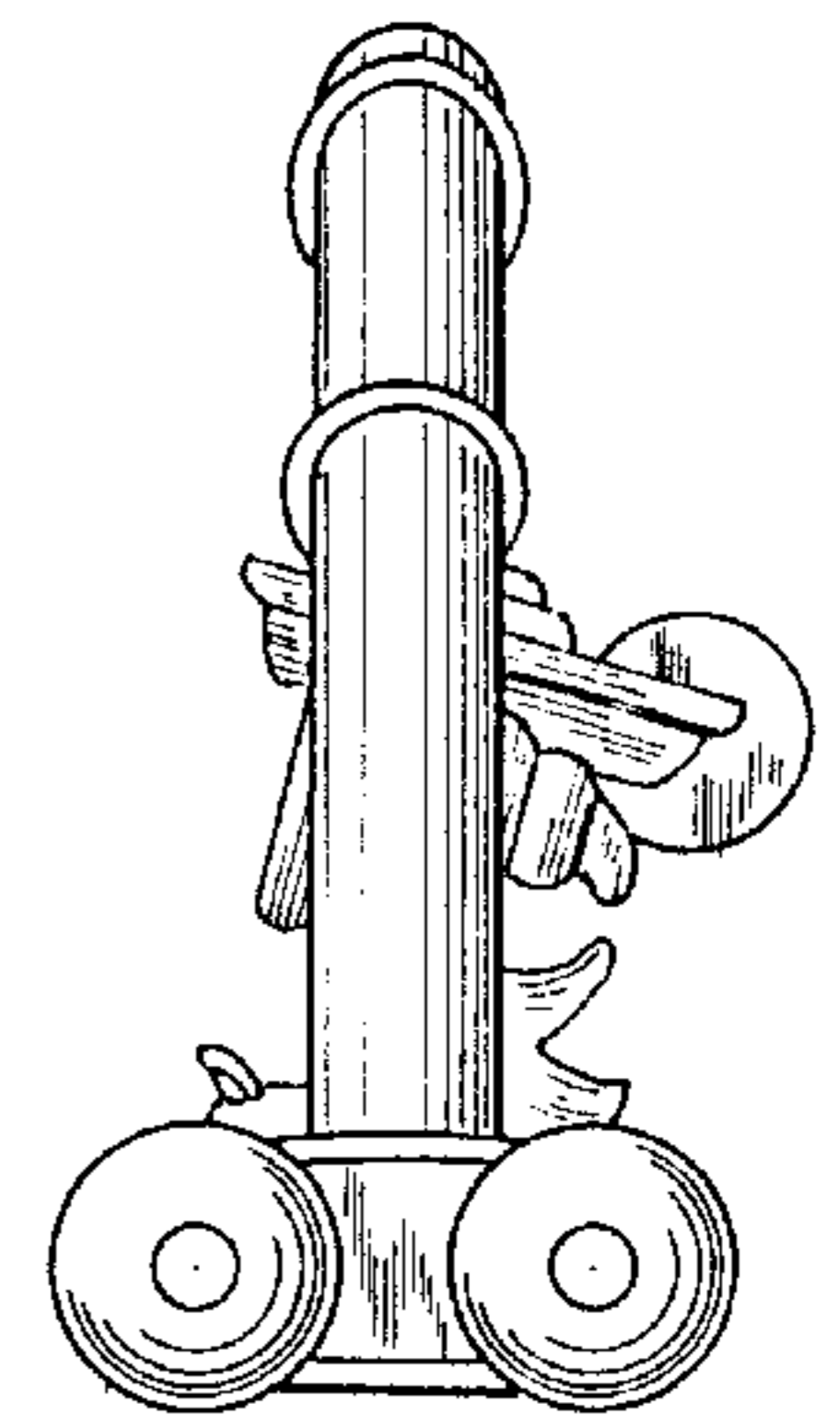

FIG. 7