



US00D403568S

United States Patent [19] Liu

[11] **Patent Number: Des. 403,568**

[45] **Date of Patent: **Jan. 5, 1999**

[54] **STRIPPING AND PUNCHING TOOL**

[75] Inventor: **Danny Liu**, Taipei, Taiwan

[73] Assignee: **Dan-Chief Enterprise Co., Ltd.**,
Taipei, Taiwan

[**] Term: **14 Years**

[21] Appl. No.: **61,126**

[22] Filed: **Oct. 16, 1996**

Related U.S. Application Data

[63] Continuation-in-part of Ser. No. 425,948, Apr. 19, 1995,
abandoned.

[51] **LOC (6) Cl.** **08-05**

[52] **U.S. Cl.** **D8/105; D8/51; D8/98**

[58] **Field of Search** D8/14, 51, 98,
D8/105; 30/90.4, 90.6, 91.2, 91.1, 358;
81/9.4, 9.43, 9.44; 7/107

[56] References Cited

U.S. PATENT DOCUMENTS

D. 335,251 5/1993 Nilsson D8/98
D. 359,214 6/1995 Carlson, Jr. et al. D8/51
4,064,581 12/1977 Kober 29/764

4,451,848 5/1984 Goodrich 7/107
4,451,947 6/1984 Frieber 7/107
4,569,128 2/1986 Thomas 7/107 X
4,829,671 5/1989 Cheng 30/90.1
5,205,006 4/1993 Panasuk 7/108
5,435,029 7/1995 Carlson 140/123

Primary Examiner—Martie K. Holtje

[57] CLAIM

The ornamental design for a stripping and punching tool, as shown and described.

DESCRIPTION

FIG. 1 is a perspective view showing a preferred embodiment of the stripping and punching tool of my new design; FIG. 2 is a top view of the preferred embodiment; FIG. 3 is a bottom view of the preferred embodiment; FIG. 4 is a front elevational view of the preferred embodiment; FIG. 5 is a rear view of the preferred embodiment; FIG. 6 is a left side view of the preferred embodiment; FIG. 7 is a right side view of the preferred embodiment; FIG. 8 is a perspective view showing the other preferred embodiment of the stripping and punching tool; and, FIG. 9 is a further perspective view of the other preferred embodiment shown in FIG. 8.

1 Claim, 6 Drawing Sheets

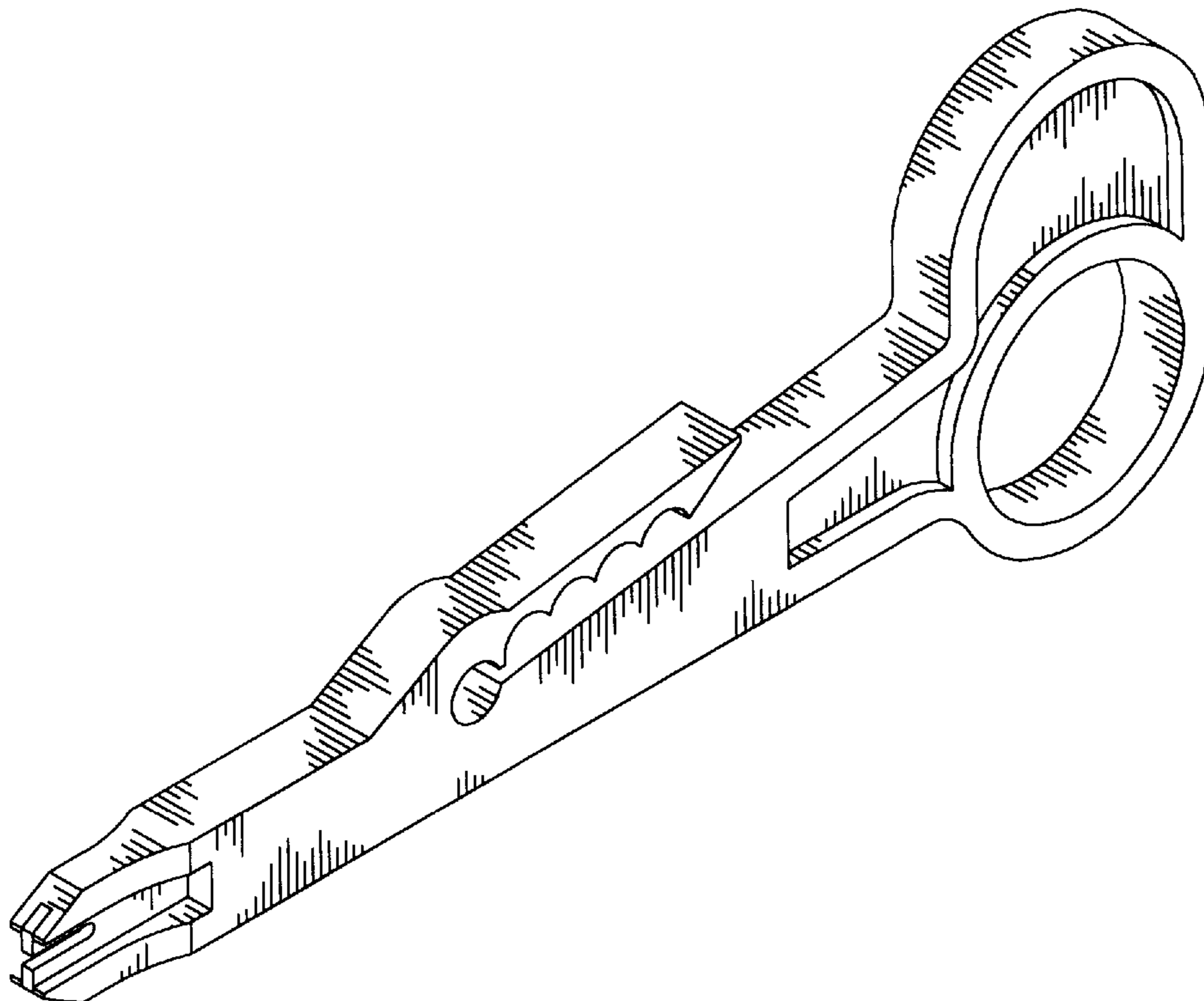

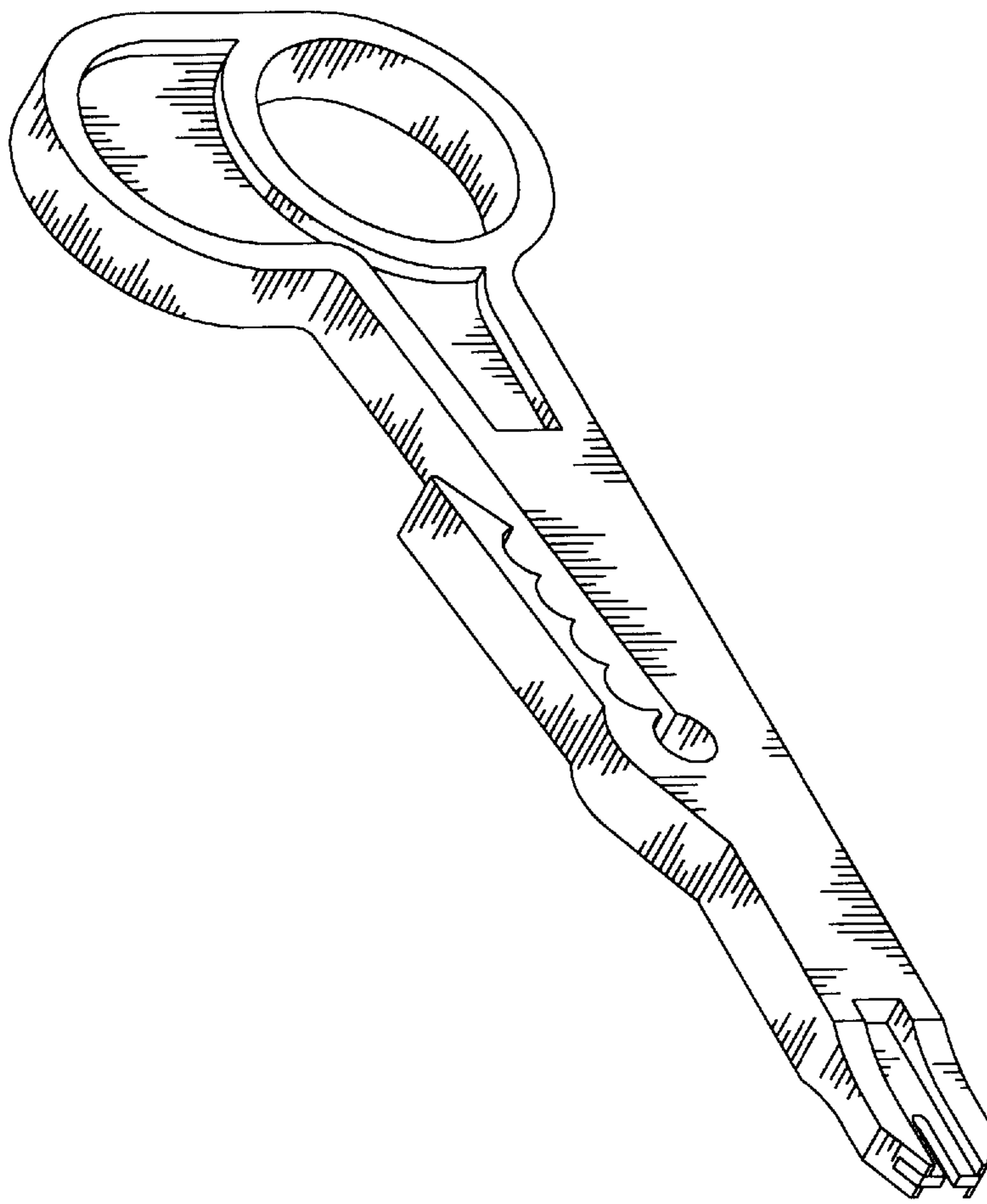

Fig. 1

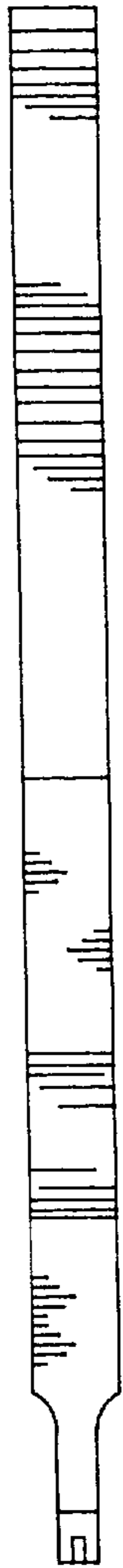

Fig. 2

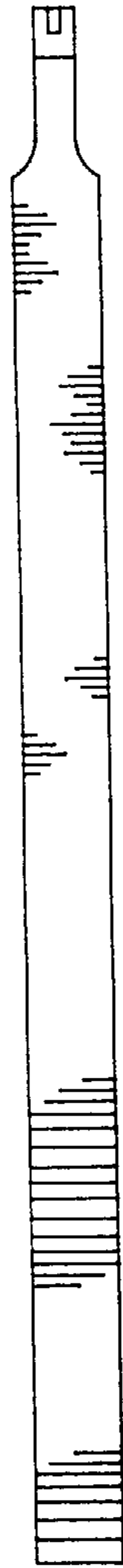

Fig. 3

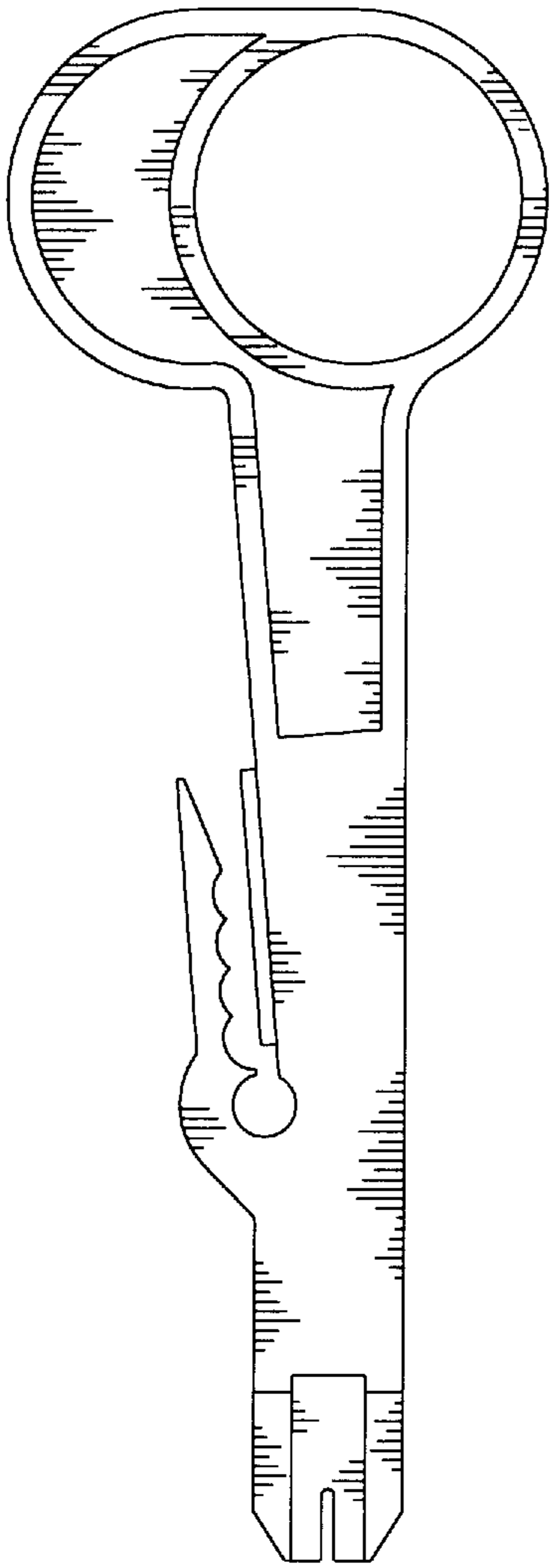

Fig. 4

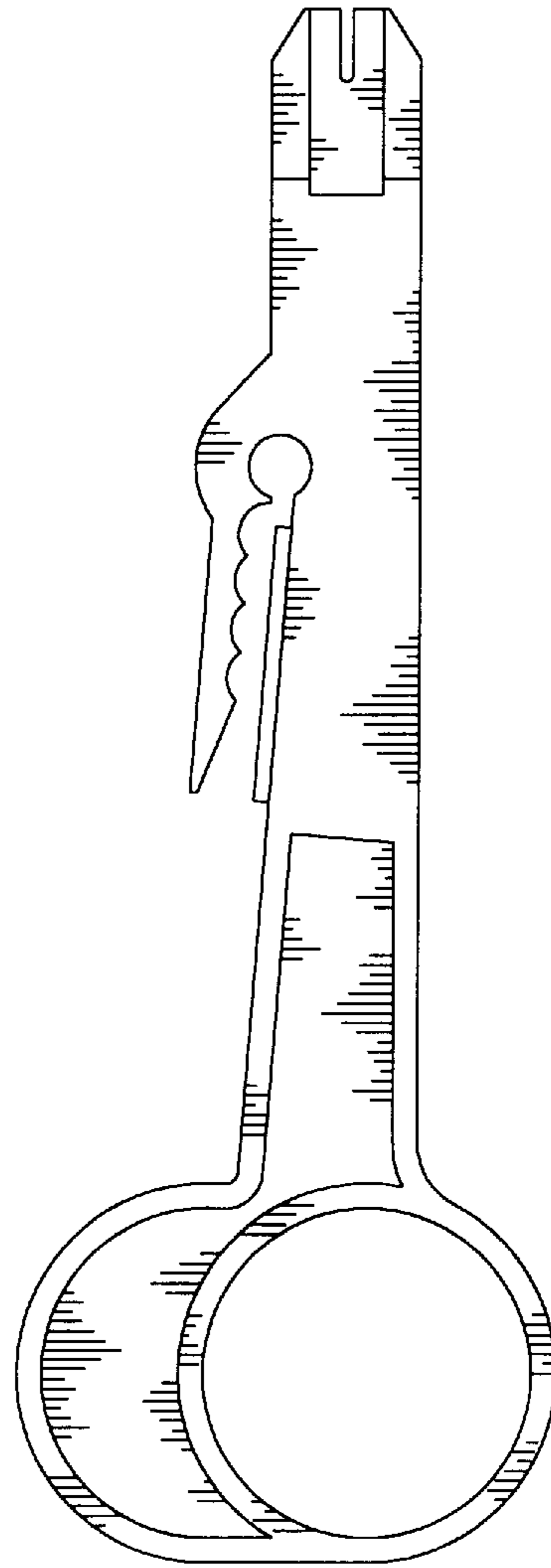

Fig. 5

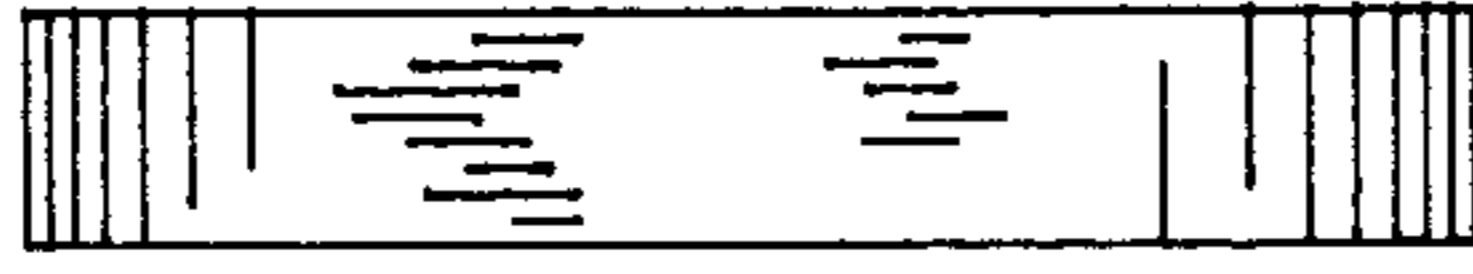

Fig. 7



Fig. 6

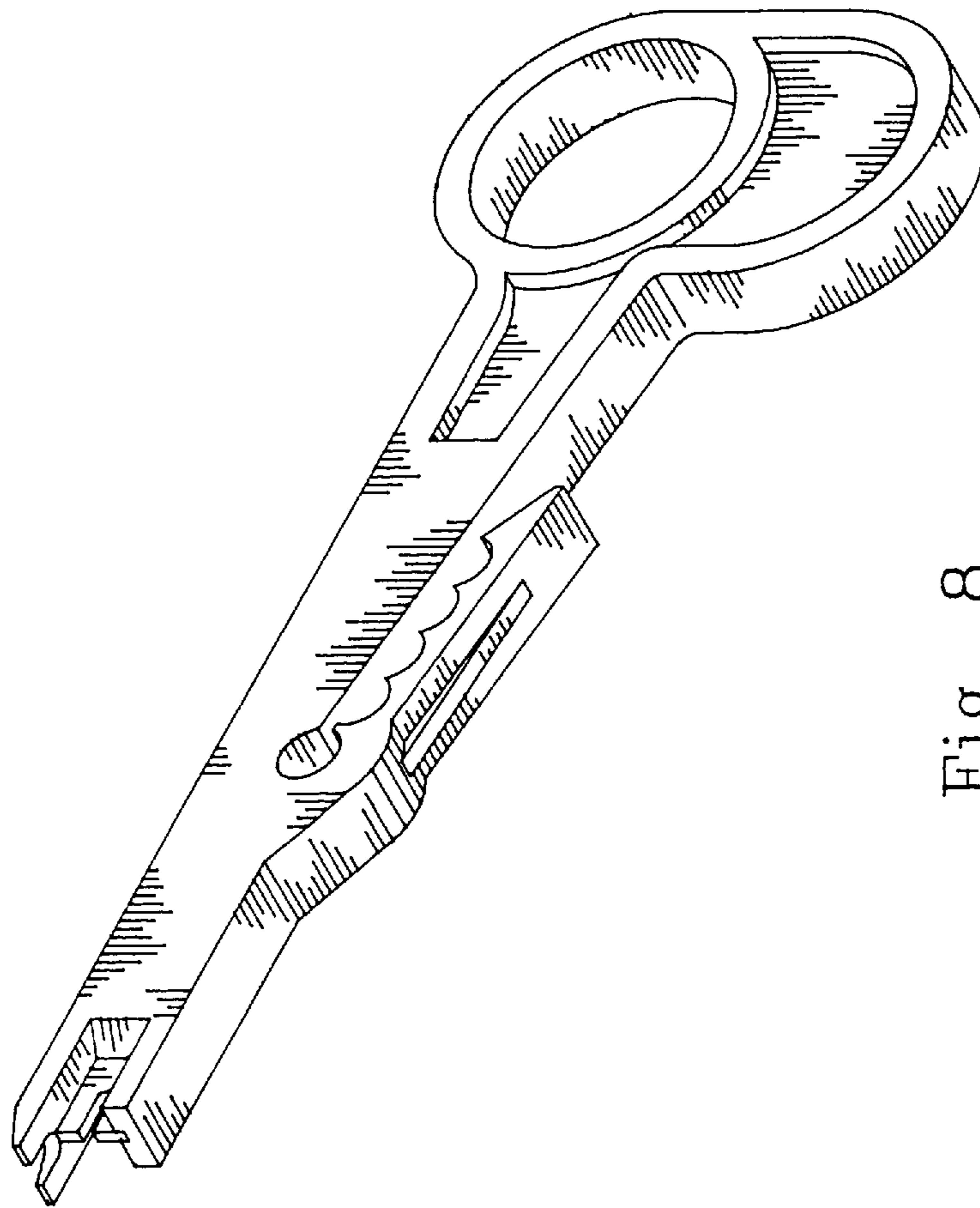

Fig. 8

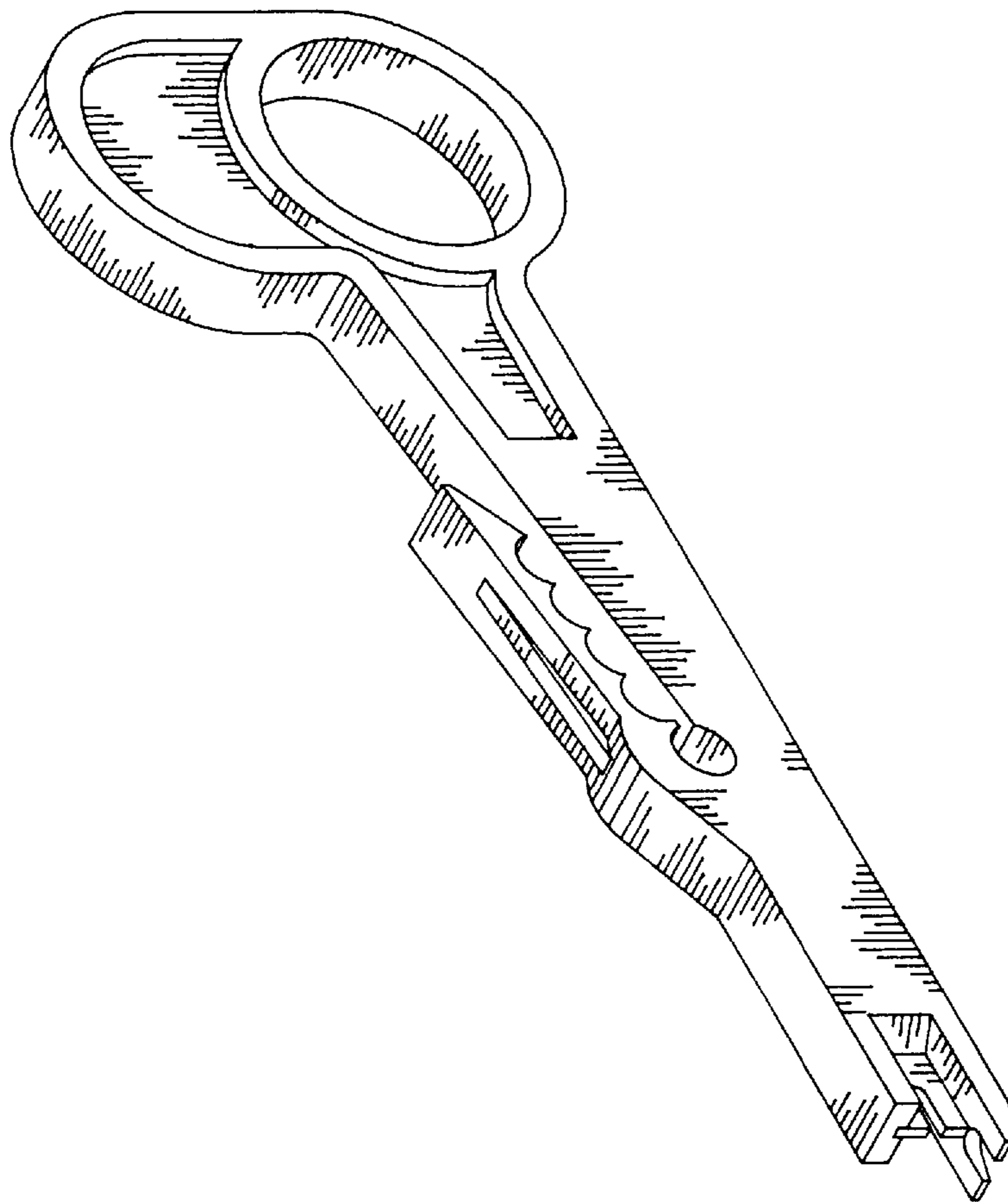

Fig. 9