



US00D403511S

# United States Patent [19] Serbinski

[11] **Patent Number: Des. 403,511**

[45] **Date of Patent: \*\*Jan. 5, 1999**

[54] **COMBINED TOOTHBRUSH HANDLE AND IRRIGATOR APPLIANCE UNIT**

[75] Inventor: **Andrew Serbinski**, Annadale, N.J.

[73] Assignee: **Teledyne Industries, Inc.**, Ft. Collins, Colo.

[\*\*] Term: **14 Years**

[21] Appl. No.: **10,084**

[22] Filed: **Jun. 25, 1993**

[51] **LOC (6) Cl. .... 04-02**

[52] **U.S. Cl. .... D4/108; D4/101**

[58] **Field of Search** ..... D4/101, 104-112, D4/116, 119, 134, 138, 199; D6/528, 534; D13/108; D24/108, 111, 176; 15/22.1, 22.2, 23, 24, 28, 105-106, 143.1, 159.1, 160, 167.1, 167.2; 132/308, 310; 601/141-142, 162-163, 165, 139

[56] **References Cited**

**U.S. PATENT DOCUMENTS**

D. 318,918	8/1991	Hartwein	.....	D24/111
D. 346,212	4/1994	Hösl	.....	D24/111
3,536,065	10/1970	Moret	.....	601/139 X
4,141,352	2/1979	Ebner et al.	.....	601/162
4,644,937	2/1987	Hommann	.....	601/162

*Primary Examiner*—A. Hugo Word  
*Assistant Examiner*—Lavone D. Tabor  
*Attorney, Agent, or Firm*—Dean P. Edmundson

[57] **CLAIM**

The ornamental design for a combined toothbrush handle and irrigator appliance unit, as shown and described.

**DESCRIPTION**

FIG. 1 is an isometric view of a combined toothbrush handle and irrigator appliance unit showing my new design; FIG. 2 is front elevational view thereof, shown with the toothbrush head and the irrigator tip removed from their respective handles and placed in the stored position; FIG. 3 is a rear elevational view thereof; FIG. 4 is a top plan view thereof; FIG. 5 is a left side elevational view thereof; FIG. 6 is a right side elevational view thereof; FIG. 7 is a front elevational view thereof but with a reservoir inverted to a storage position; FIG. 8 is a rear elevational view thereof; FIG. 9 is a top plan view thereof as in FIG. 7; FIG. 10 is a left side elevational view thereof as in FIG. 7; FIG. 11 is a right side elevational view thereof as in FIG. 7; and, FIG. 12 is a bottom plan view thereof. The broken lines showing of bristles are for illustrative purposes only and form no part of the claimed design.

**1 Claim, 7 Drawing Sheets**

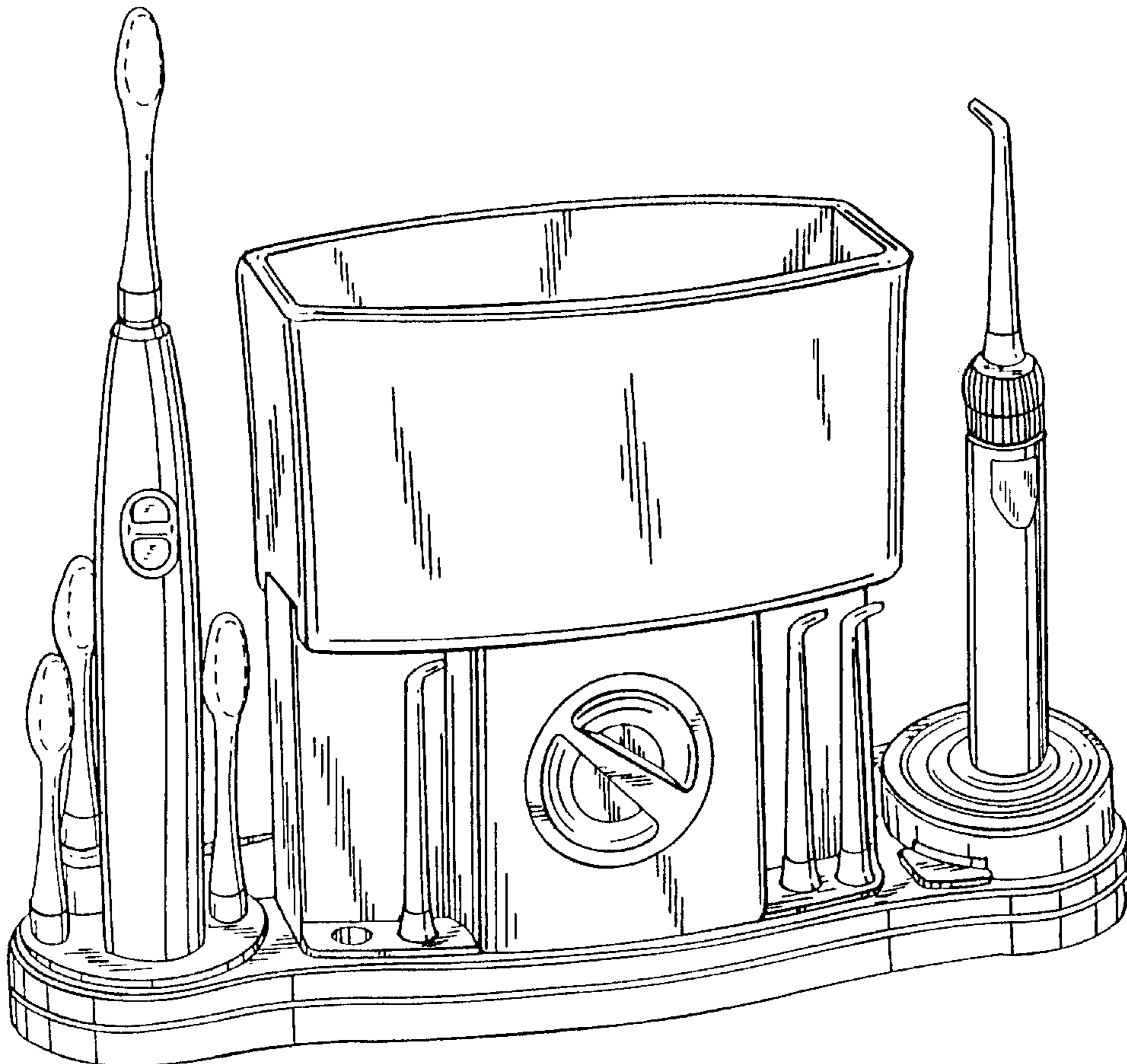

FIG. 1

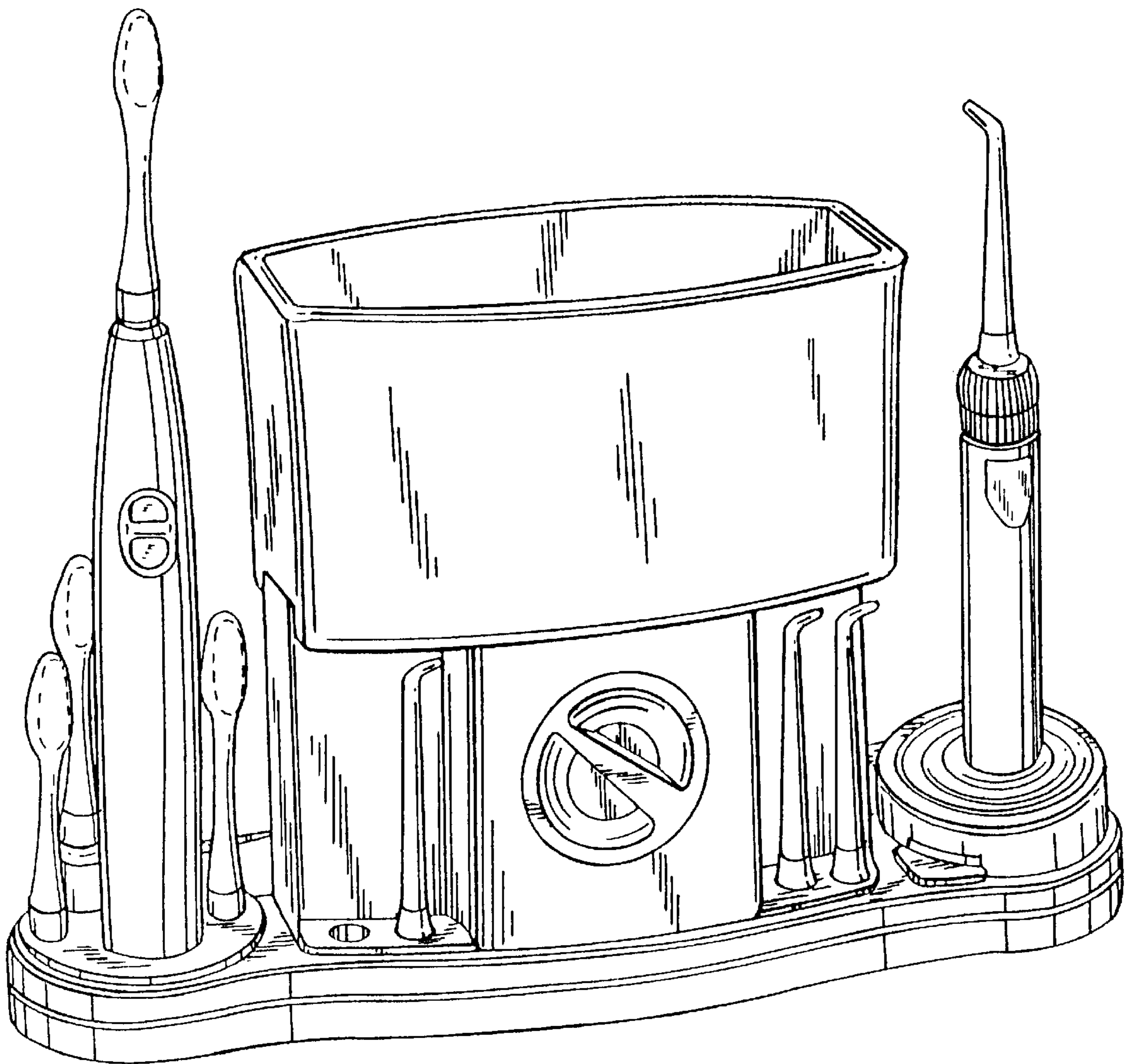

FIG.12

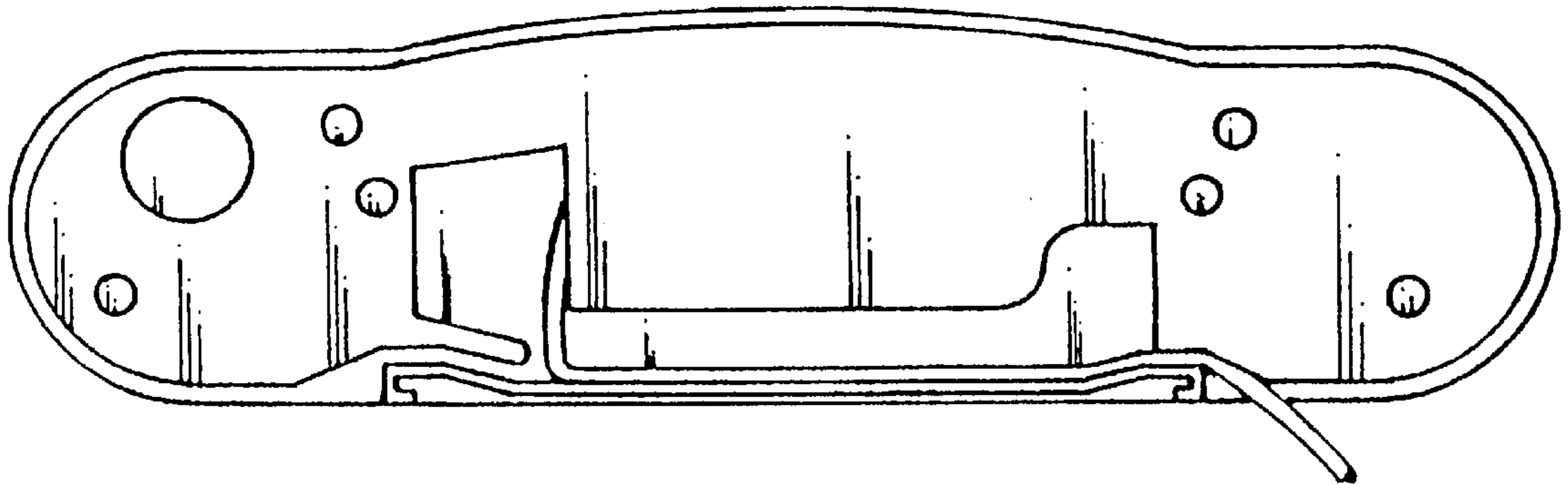

FIG.2

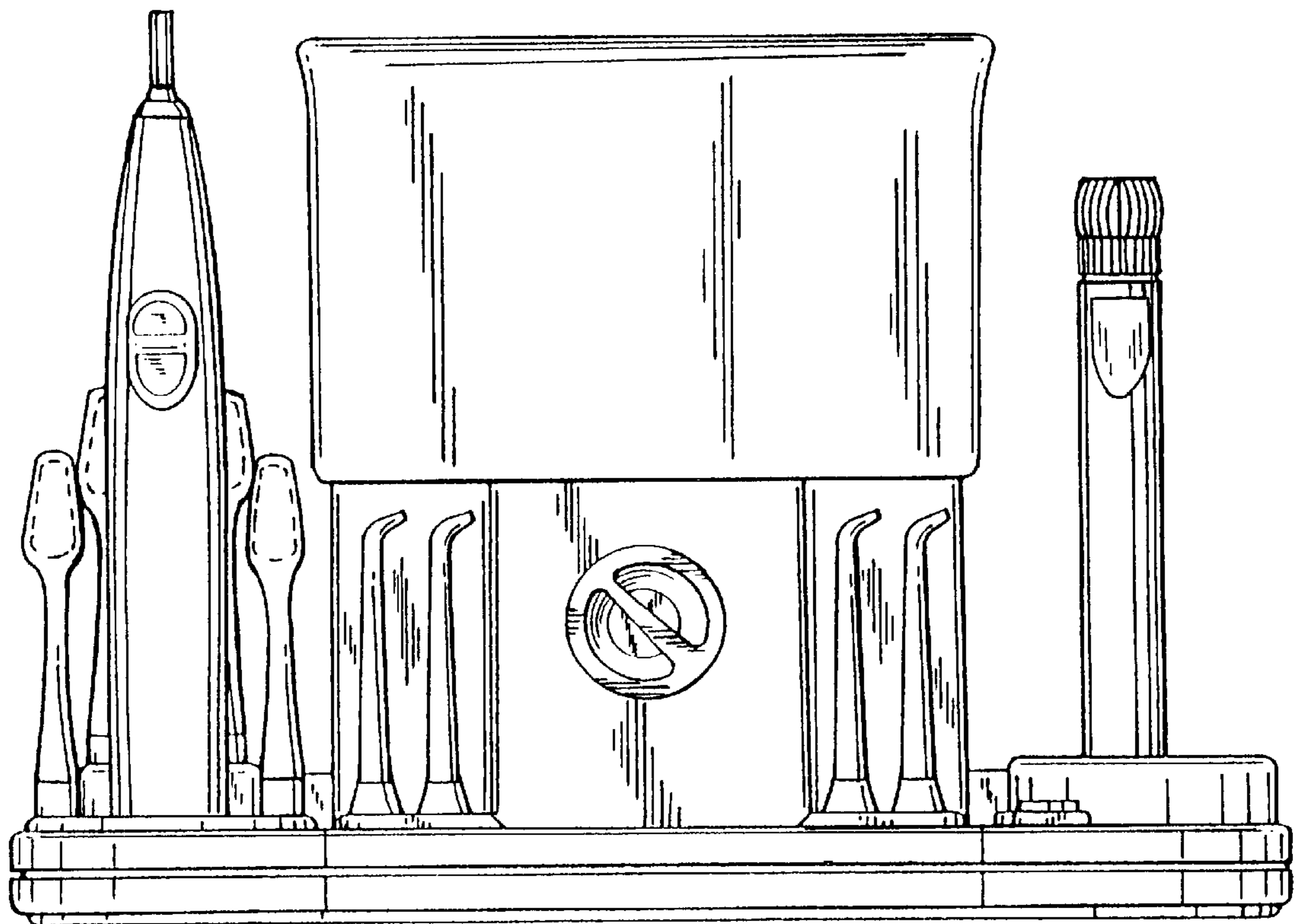

FIG. 4

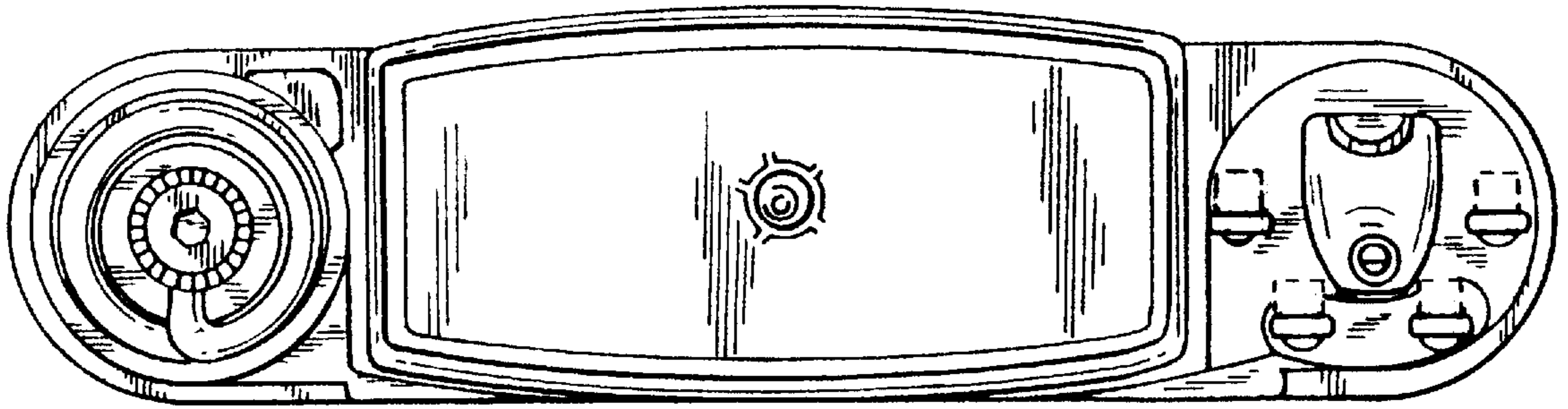

FIG. 3

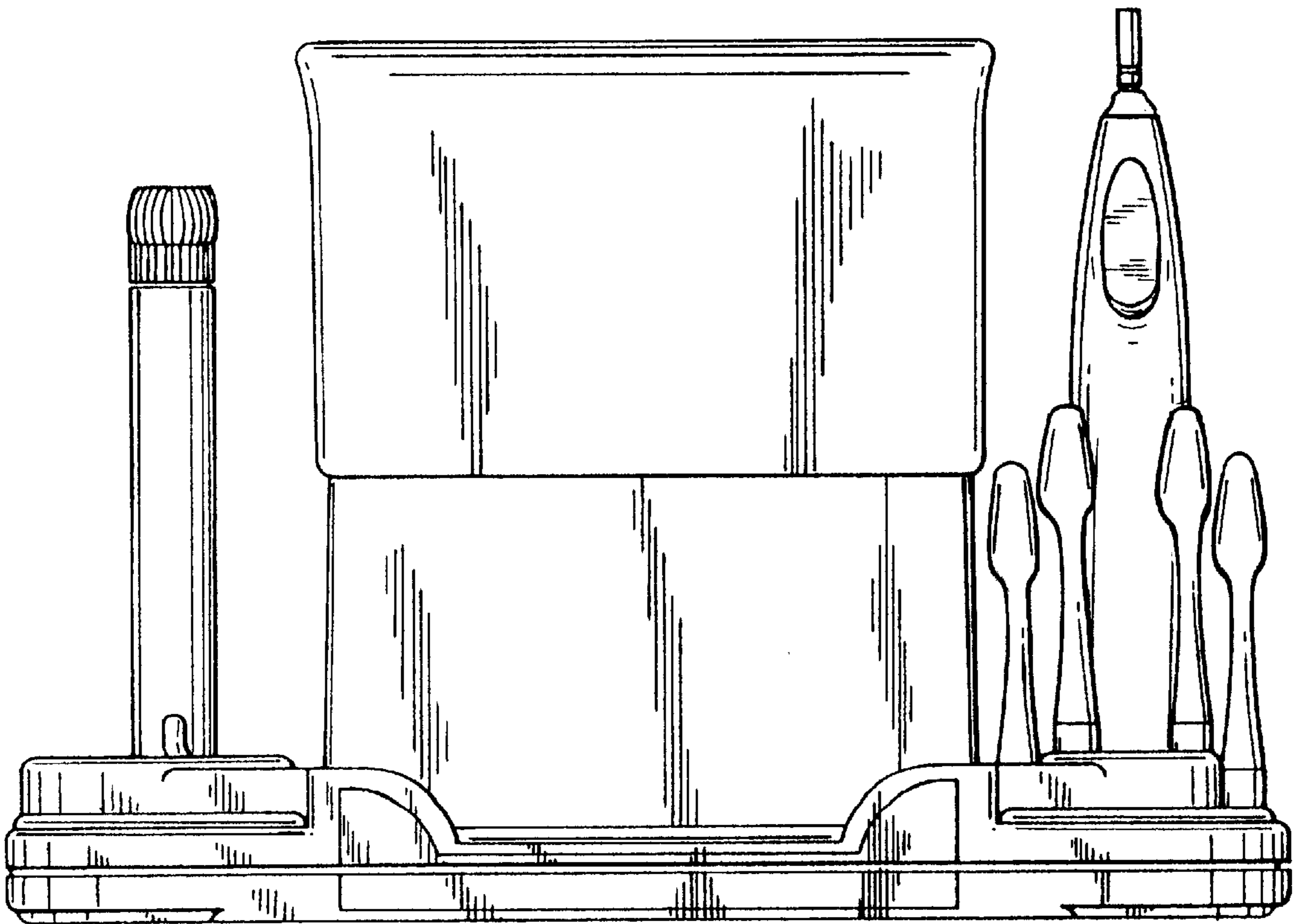

FIG.5

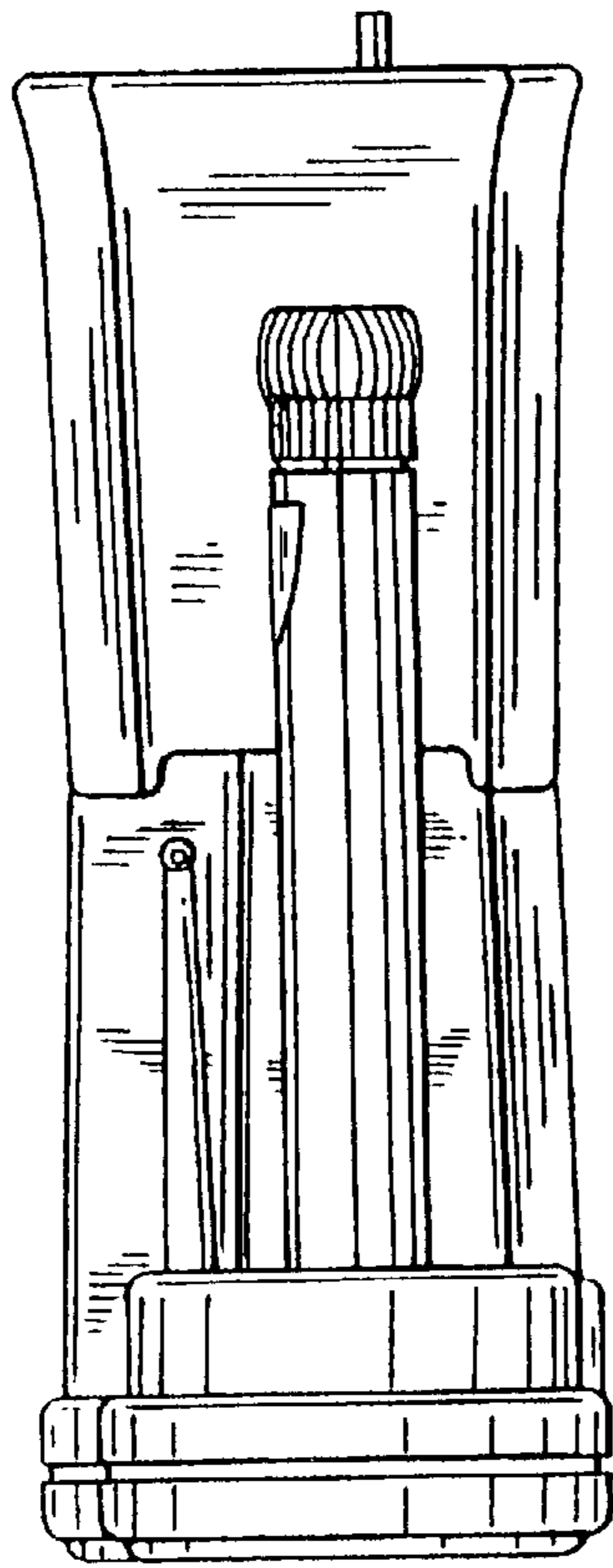

FIG.6

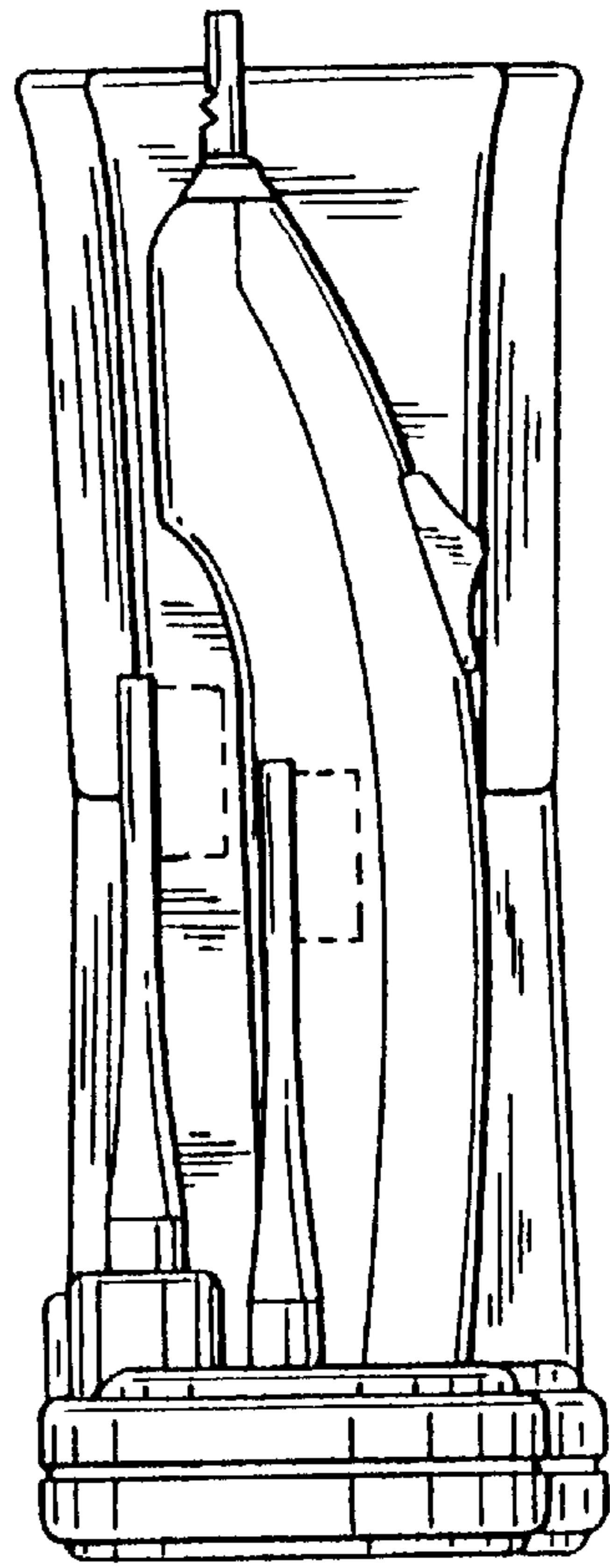

FIG. 7

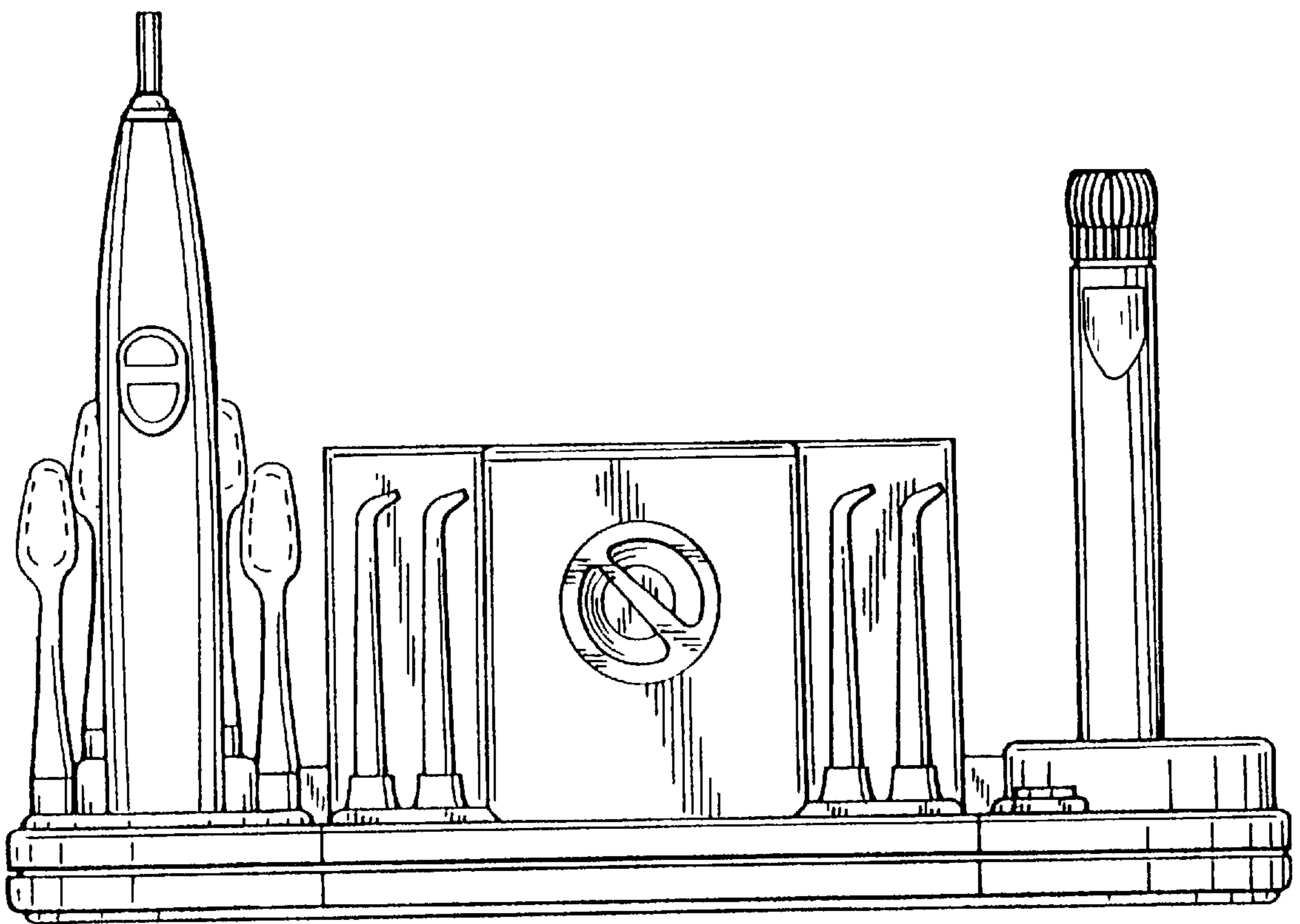

FIG. 9

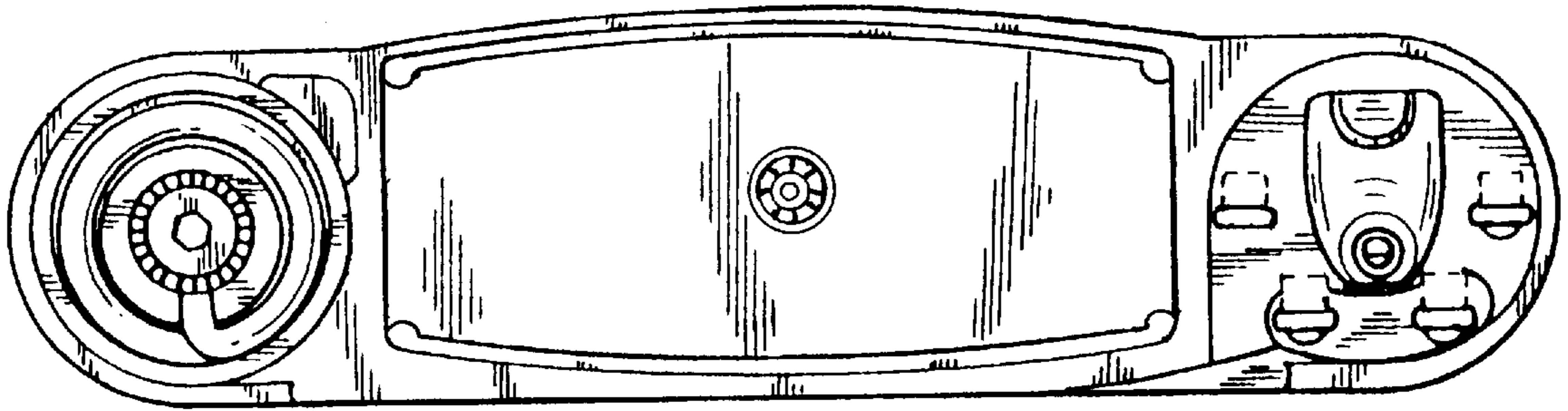

FIG. 8

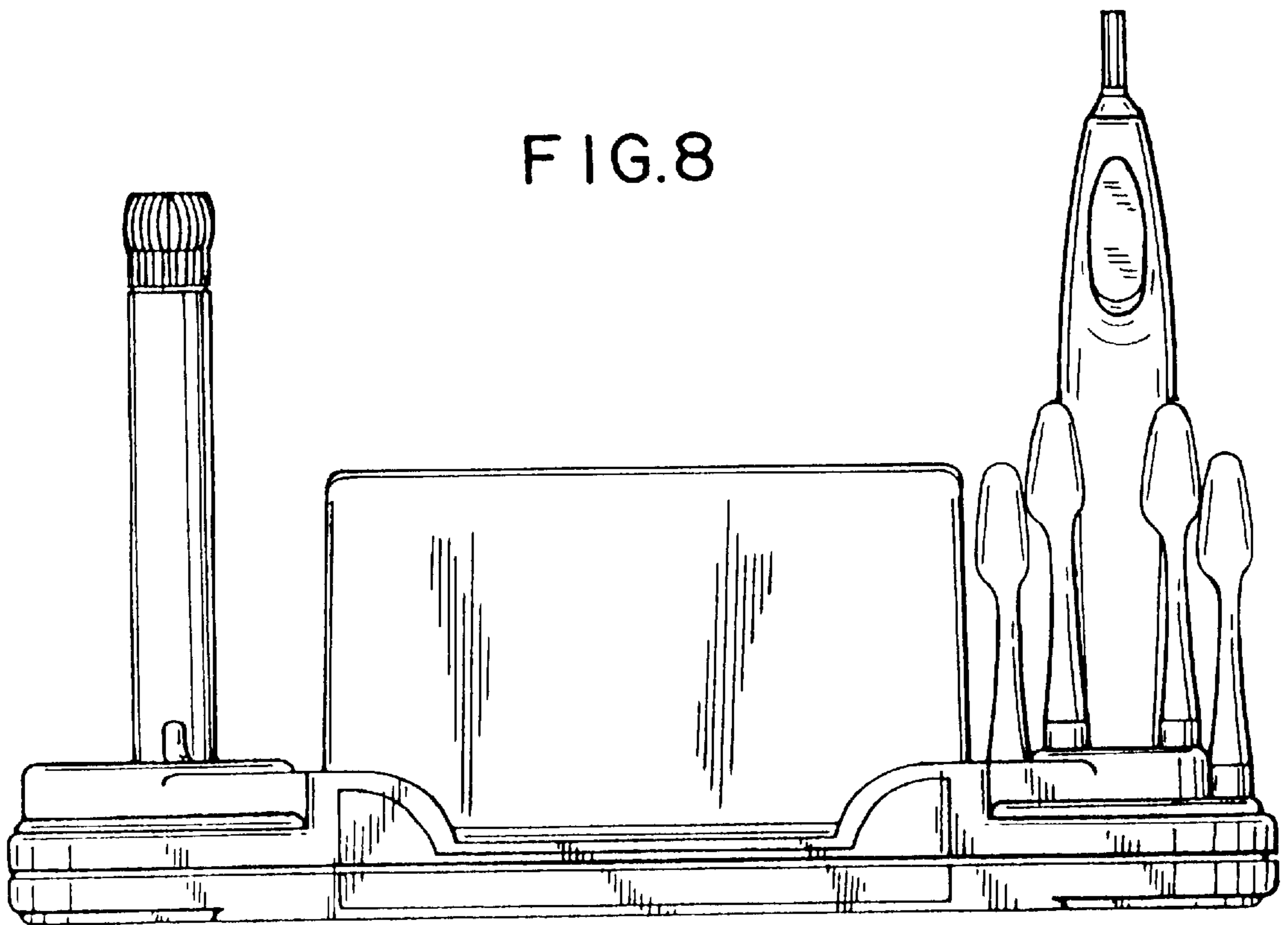

FIG.10

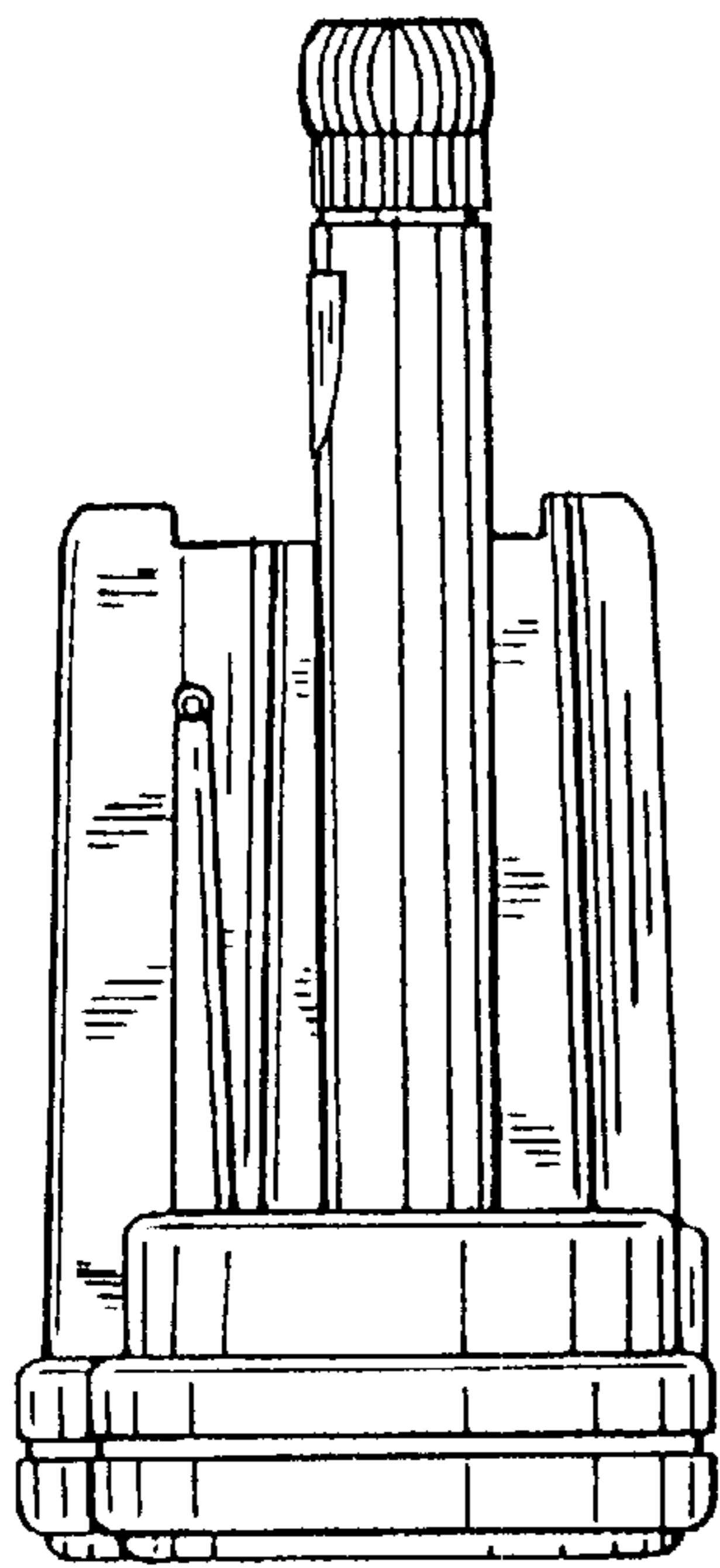

FIG.11

