



US00D403508S

# United States Patent [19]

[11] **Patent Number: Des. 403,508**

**Kheradpir et al.**

[45] **Date of Patent: \*\*Jan. 5, 1999**

[54] **ROUTER BIT CASE**

[75] Inventors: **Kamyar Kheradpir**, Greenville, N.C.;  
**Cliff J. Von Hoene**, Jeffersontown, Ky.;  
**Grover C. Haddock**; **Paul J. Simon**,  
both of Greenville, N.C.

[73] Assignee: **Credo Tool Company**, Woodburn,  
Oreg.

[\*\*] Term: **14 Years**

[21] Appl. No.: **60,842**

[22] Filed: **Oct. 8, 1996**

[51] **LOC (6) Cl.** ..... **03-01**

[52] **U.S. Cl.** ..... **D3/294; D3/905**

[58] **Field of Search** ..... **D3/905, 294, 273,**  
**D3/295; D9/415; 206/372, 379, 373**

[56] **References Cited**

**U.S. PATENT DOCUMENTS**

D. 258,705	3/1981	Wheeler	.....	D3/905
D. 264,396	5/1982	Harvey et al.	.....	D3/294
D. 271,444	11/1983	LeVine	.....	D3/905
D. 333,727	3/1993	Schurman	.....	D3/294
D. 343,063	1/1994	Chen	.....	D3/905
D. 374,988	10/1996	Hillinger	.....	D3/294
2,844,244	7/1958	Hanson	.....	206/379
3,499,525	3/1970	Kanter	.....	206/379
3,804,238	4/1974	Howard	.....	206/459

(List continued on next page.)

*Primary Examiner*—Philip S. Hyder

[57] **CLAIM**

The ornamental design for a router bit case, as shown and described.

**DESCRIPTION**

The broken lines in FIGS. 1–21 are for illustrative purposes only and form no part of the claimed design.

FIG. 1 is a top view of the router bit case showing our new design;

FIG. 2 is a bottom view of the router bit case of FIG. 1;

FIG. 3 is a front view of the router bit case of FIG. 1;

FIG. 4 is a rear view of the router bit case of FIG. 1;

FIG. 5 is a side elevational view of the router bit case of FIG. 1, wherein the opposite side elevational view is a mirror image thereof;

FIG. 6 is a top view of the router bit case of FIG. 1, shown with the cover in an open position;

FIG. 7 is a fragmentary cross section view of the router bit case, taken along line 7—7 of FIG. 6;

FIG. 8 is a fragmentary cross section view of the router bit case, taken along line 8—8 of FIG. 6;

FIG. 9 is a top view of the insertable tray of the router bit case of FIG. 1 shown removed from the router bit case of FIG. 1 for clarity;

FIG. 10 is a top view of the insertable tray of the router bit case of FIG. 1 shown removed from the router bit case of FIG. 1 for clarity and also with mounted router bits shown in broken lines which form no part of the claimed design;

FIG. 11 is a bottom view of a modified embodiment of the upper shell of the router bit case;

FIG. 12 is a top view of the upper shell of the router bit case of FIG. 11;

FIG. 13 is a top view of the lower shell of the router bit case of either FIG. 1 or FIG. 11 showing the insertable tray shown removed from the router bit case of FIG. 1 for clarity;

FIG. 14 is a top view of the modified embodiment of the router bit case;

FIG. 15 is a bottom view of the router bit case of FIG. 14;

FIG. 16 is a front perspective view of the router bit case of FIG. 14;

FIG. 17 is a back perspective view of the router bit case of FIG. 14;

FIG. 18 is a bottom front perspective view of the router bit case of FIG. 14;

FIG. 19 is a top view of the insertable tray of the router bit case of FIG. 14 shown removed from the router bit case of FIG. 14 for clarity;

FIG. 20 is a bottom view of the insertable tray of FIG. 19 shown removed from the router bit case of FIG. 14 for clarity; and,

FIG. 21 is a front perspective view of the insertable tray of FIG. 19 shown removed from the router bit case of FIG. 14 for clarity.

**1 Claim, 17 Drawing Sheets**

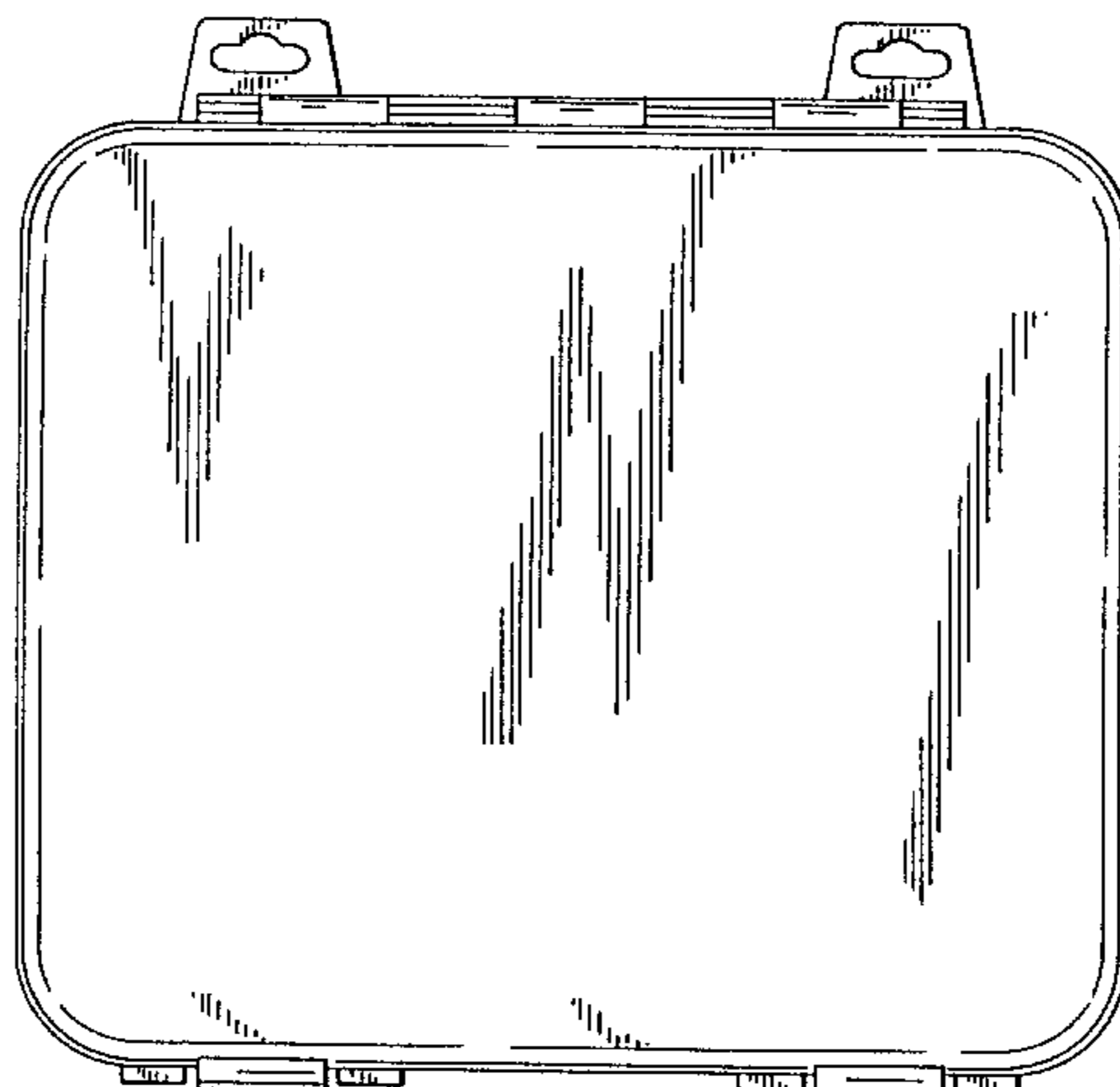

# Des. 403,508

Page 2

---

U.S. PATENT DOCUMENTS			
		4,958,732	9/1990 Rau et al. .... 206/379
		5,114,007	5/1992 Chen ..... 206/373
3,923,152	12/1975	Minneman	..... 206/372
4,293,074	10/1981	Dunsky	..... 206/572
4,619,364	10/1986	Czopor, Jr.	..... 206/379
4,834,237	5/1989	Henke et al.	..... 206/373
		5,145,064	9/1992 Chen ..... 206/372
		5,257,695	11/1993 Henke et al. .... 206/373
		5,368,164	11/1994 Bennett et al. .... 206/379
		5,429,235	7/1995 Chen ..... 206/373

FIG. 1

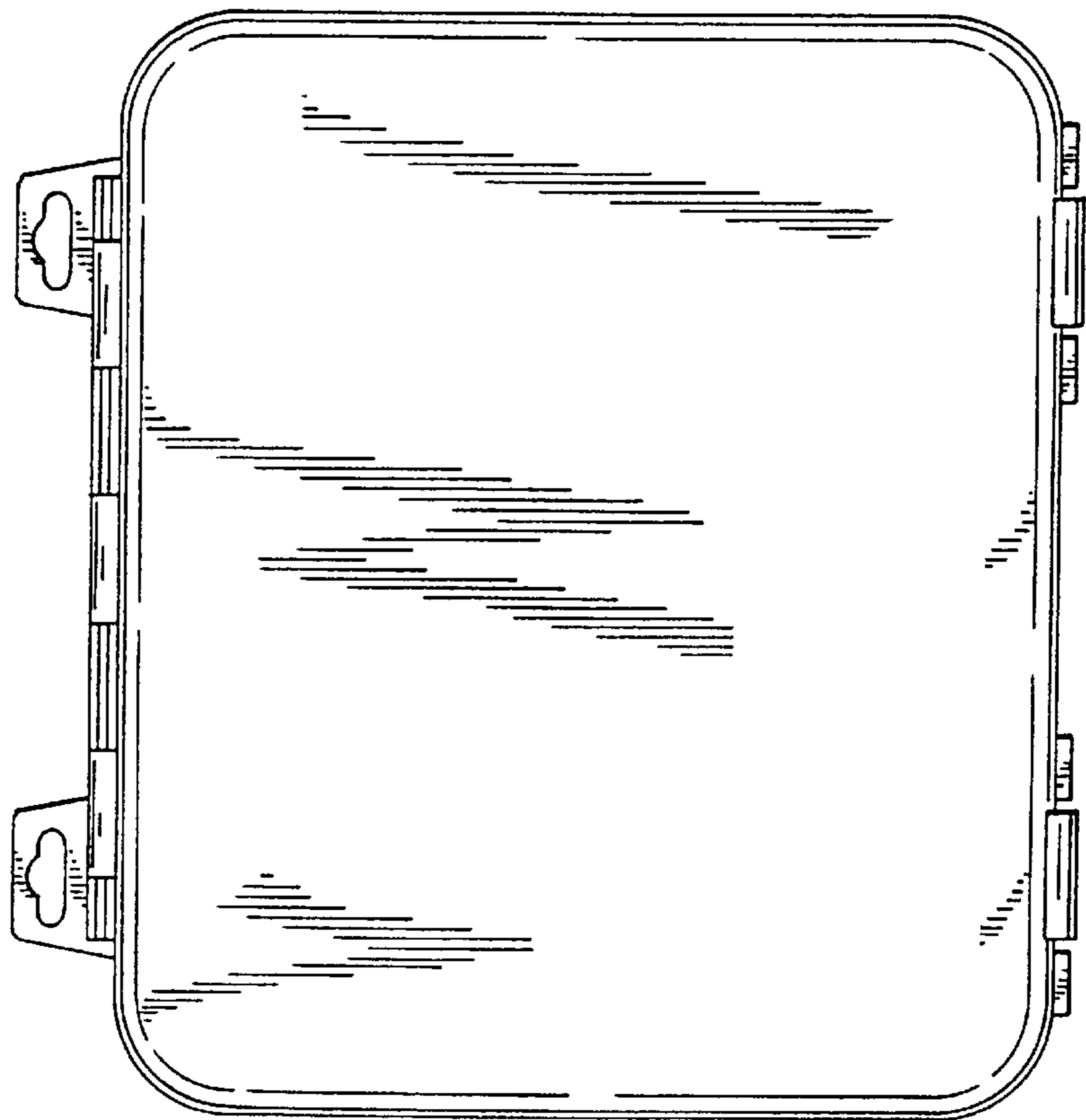

FIG. 2

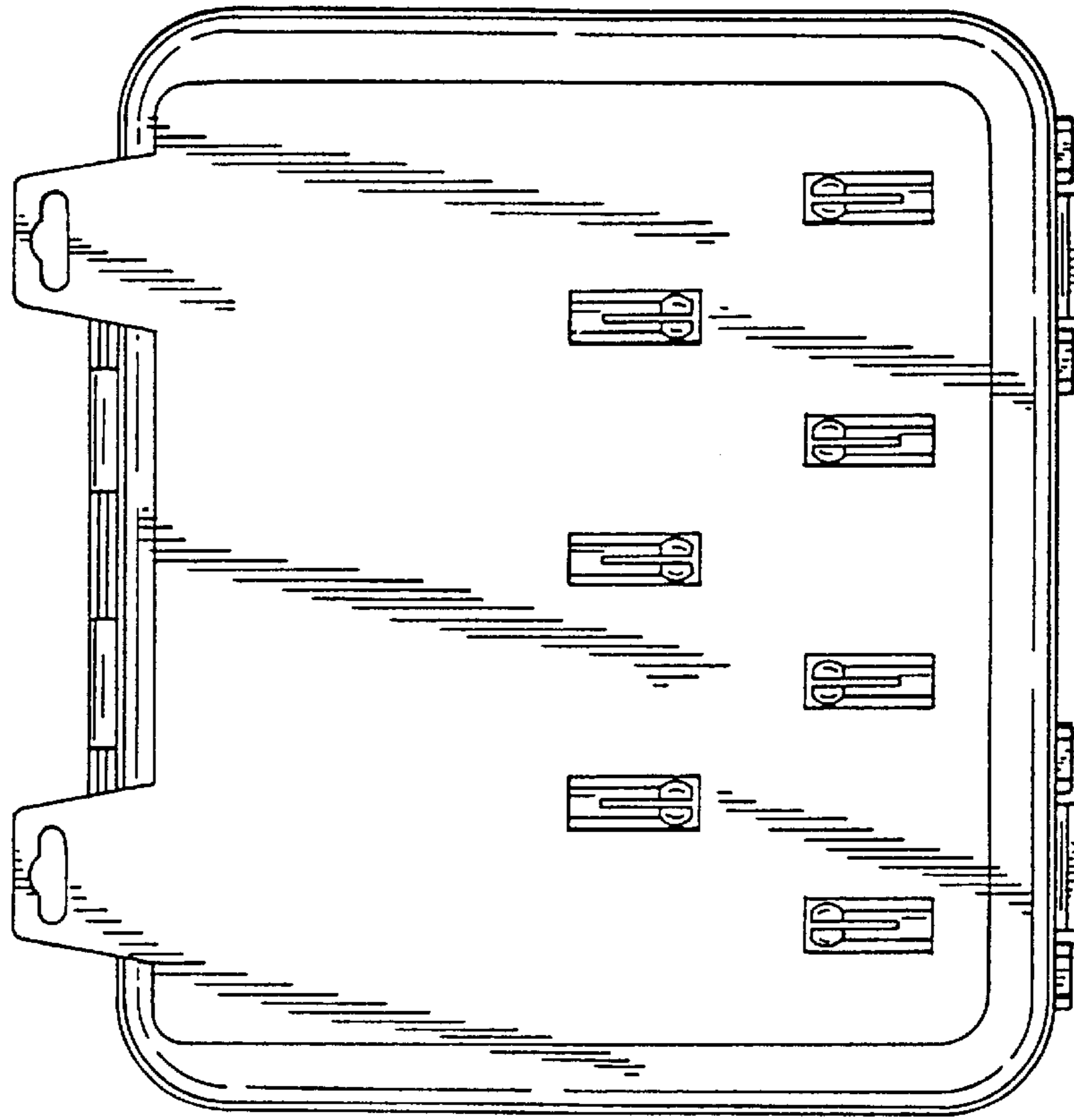

FIG. 3

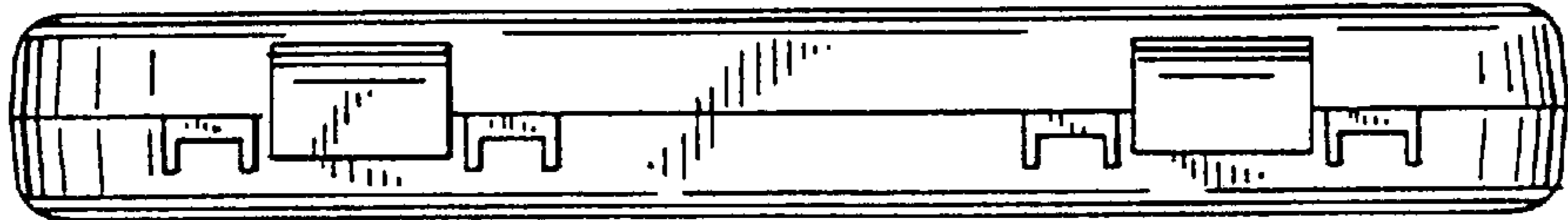

FIG. 4

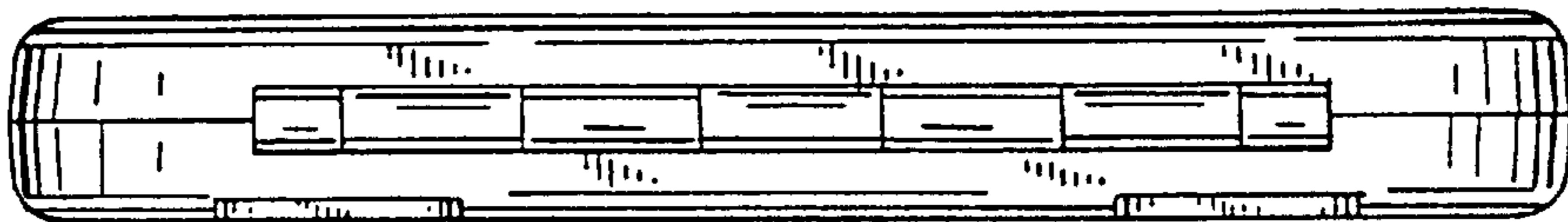

FIG. 5

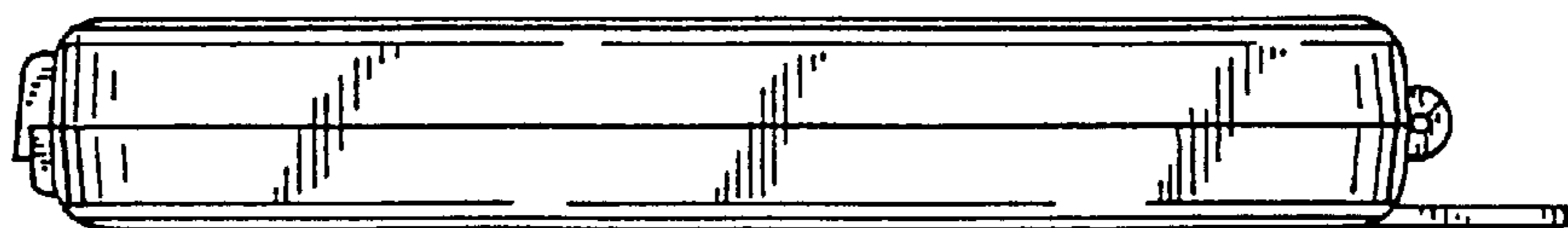

FIG. 6

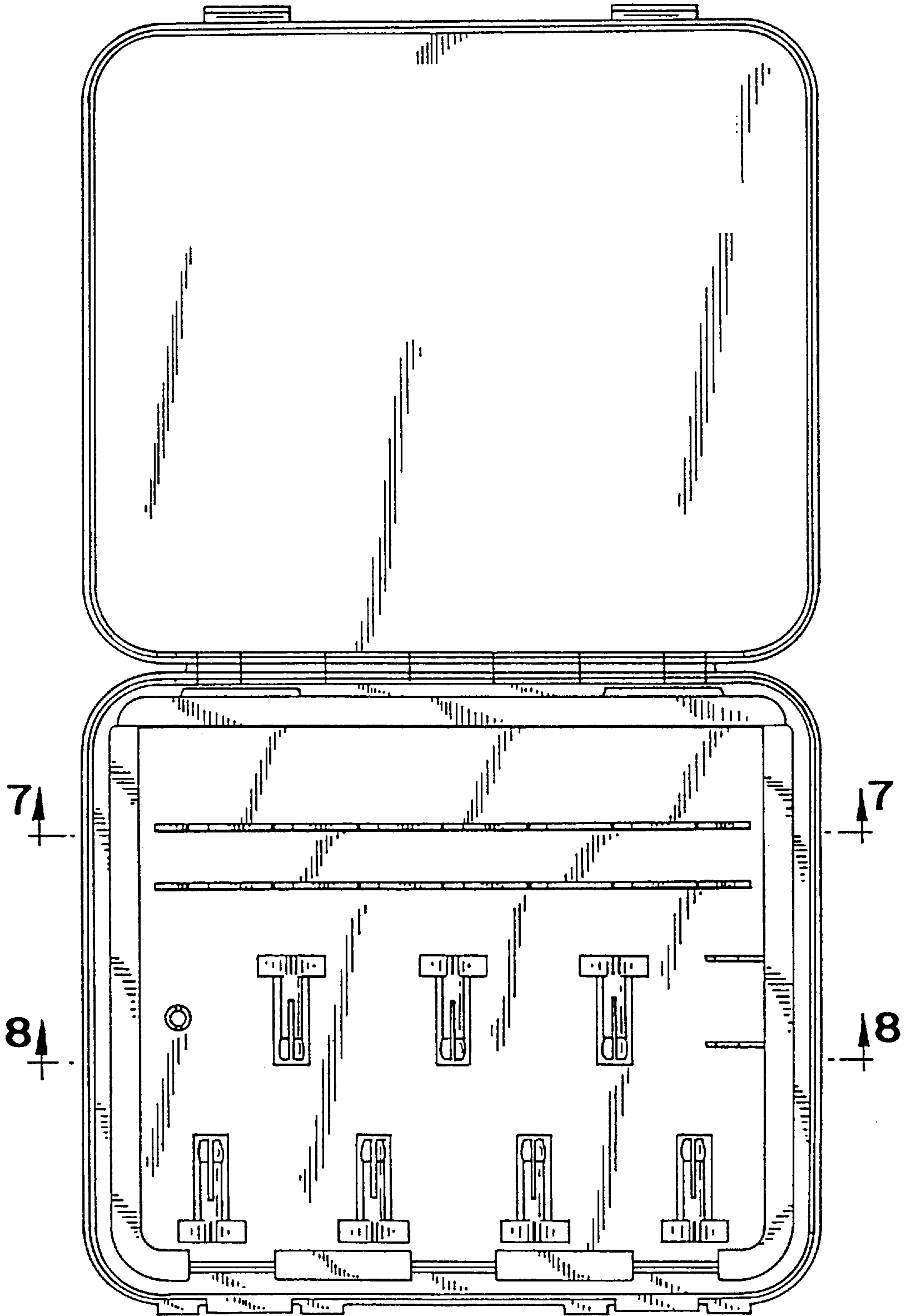

FIG. 7

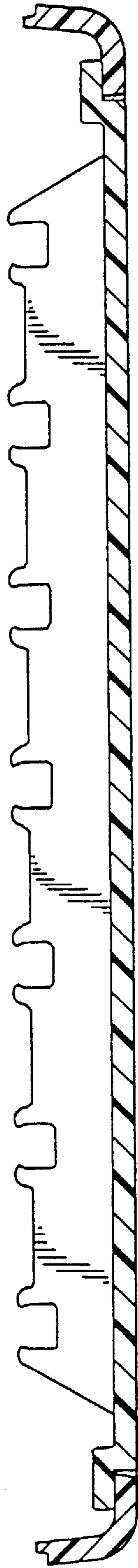

FIG. 8

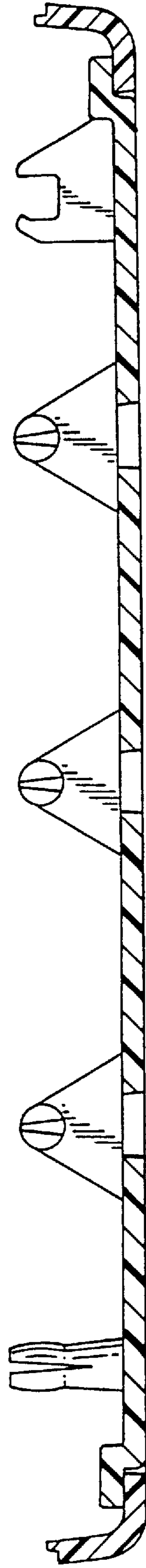

FIG. 9

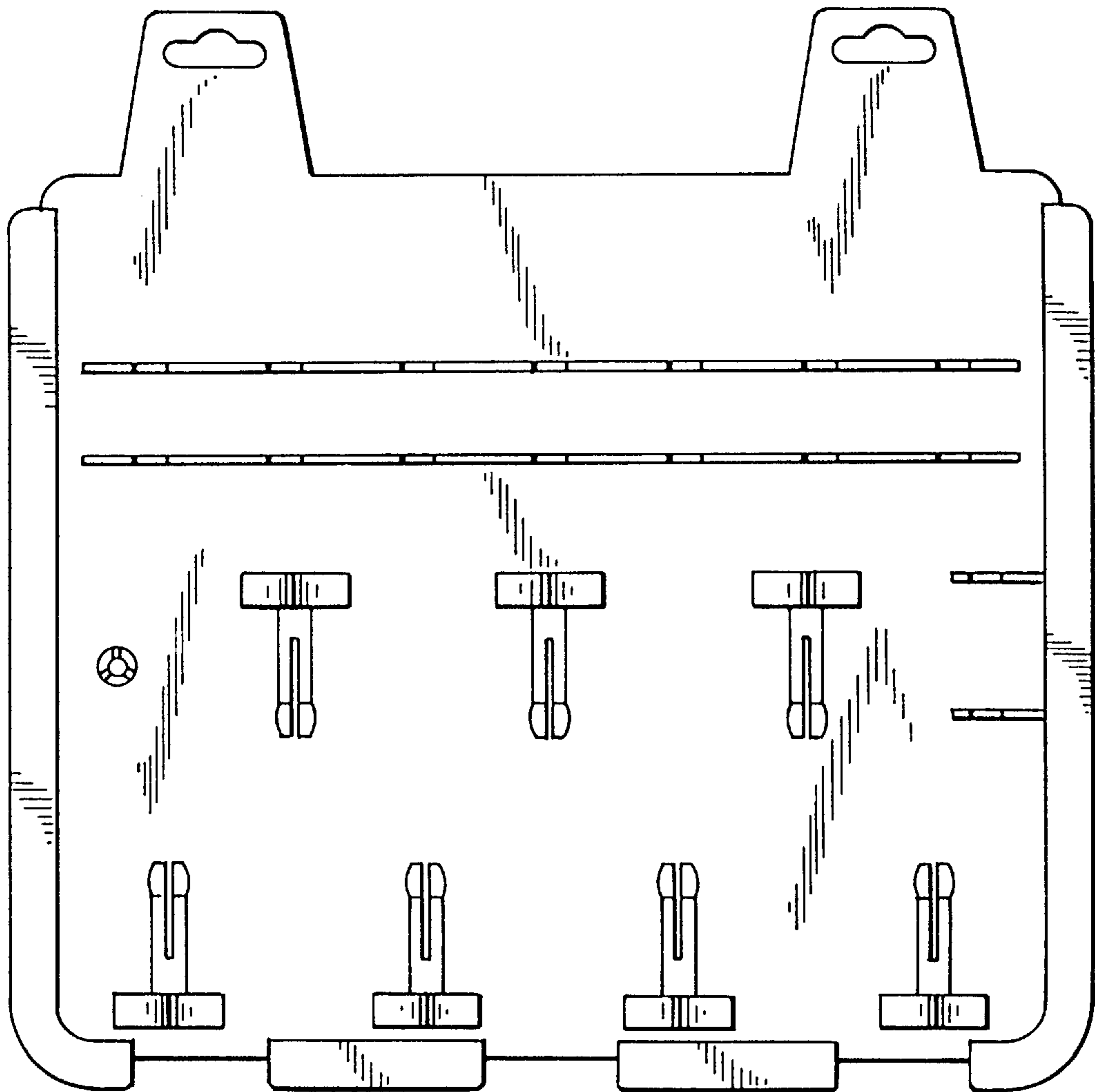

FIG. 10

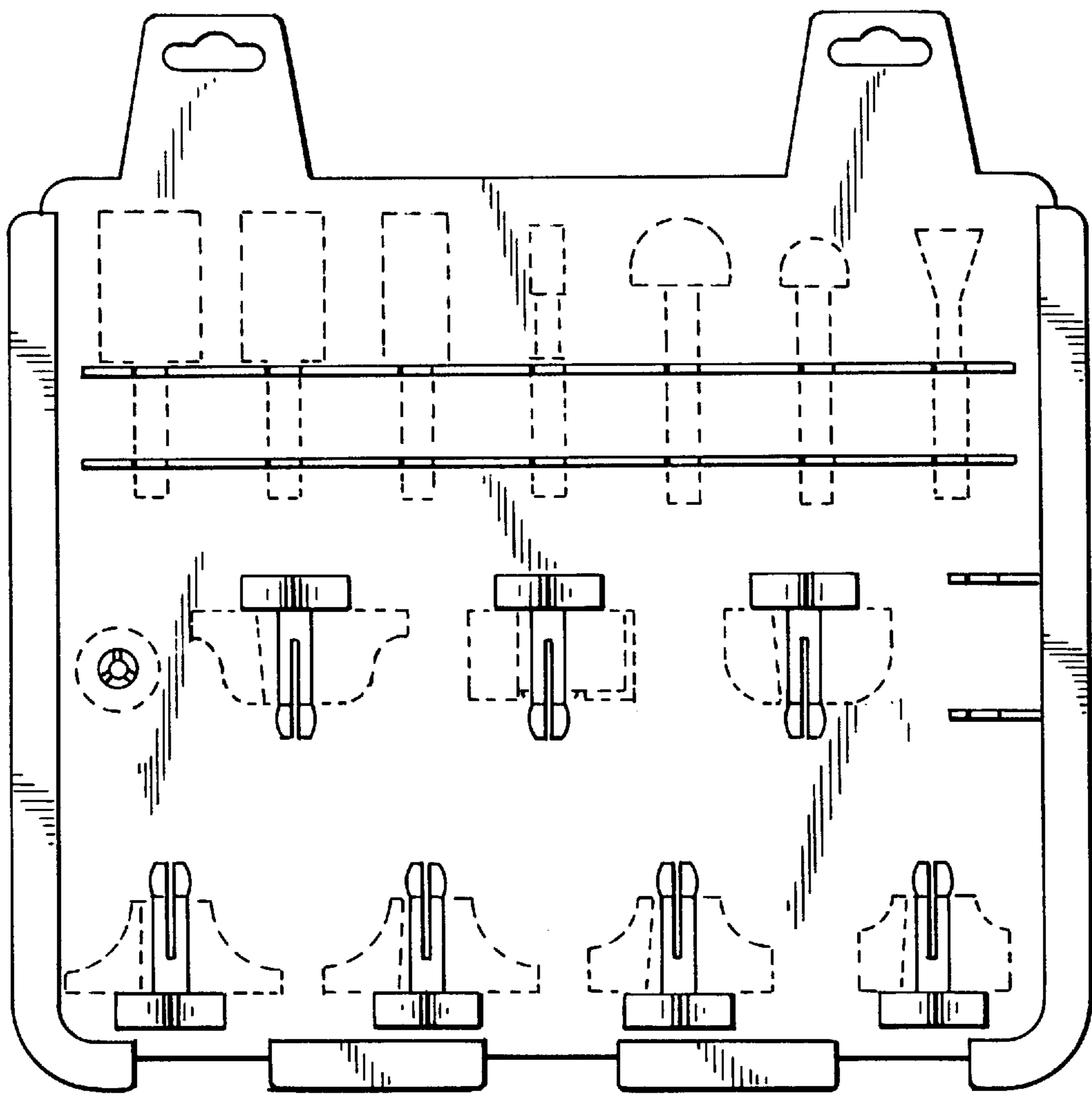



FIG. II

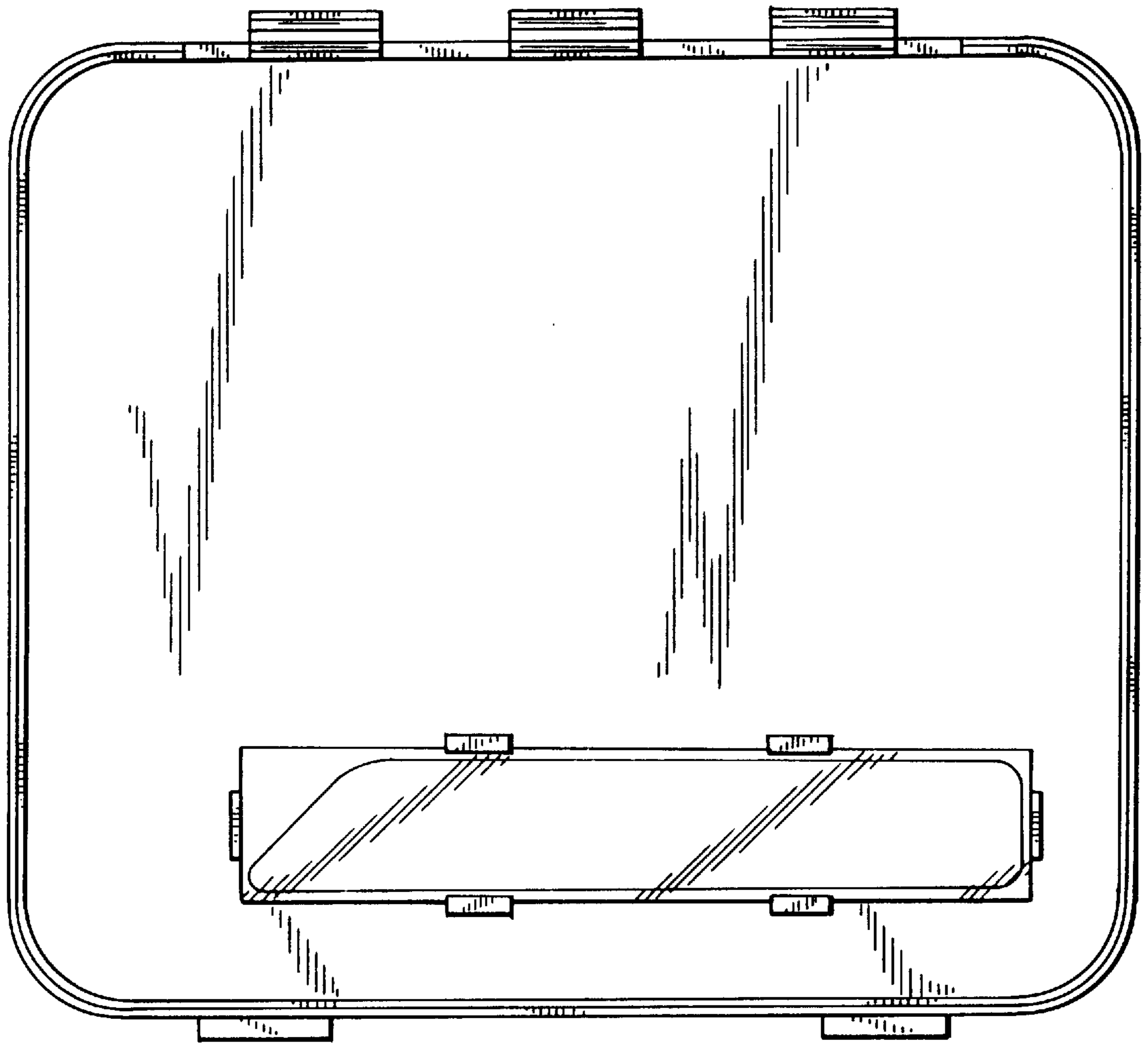

FIG. 12

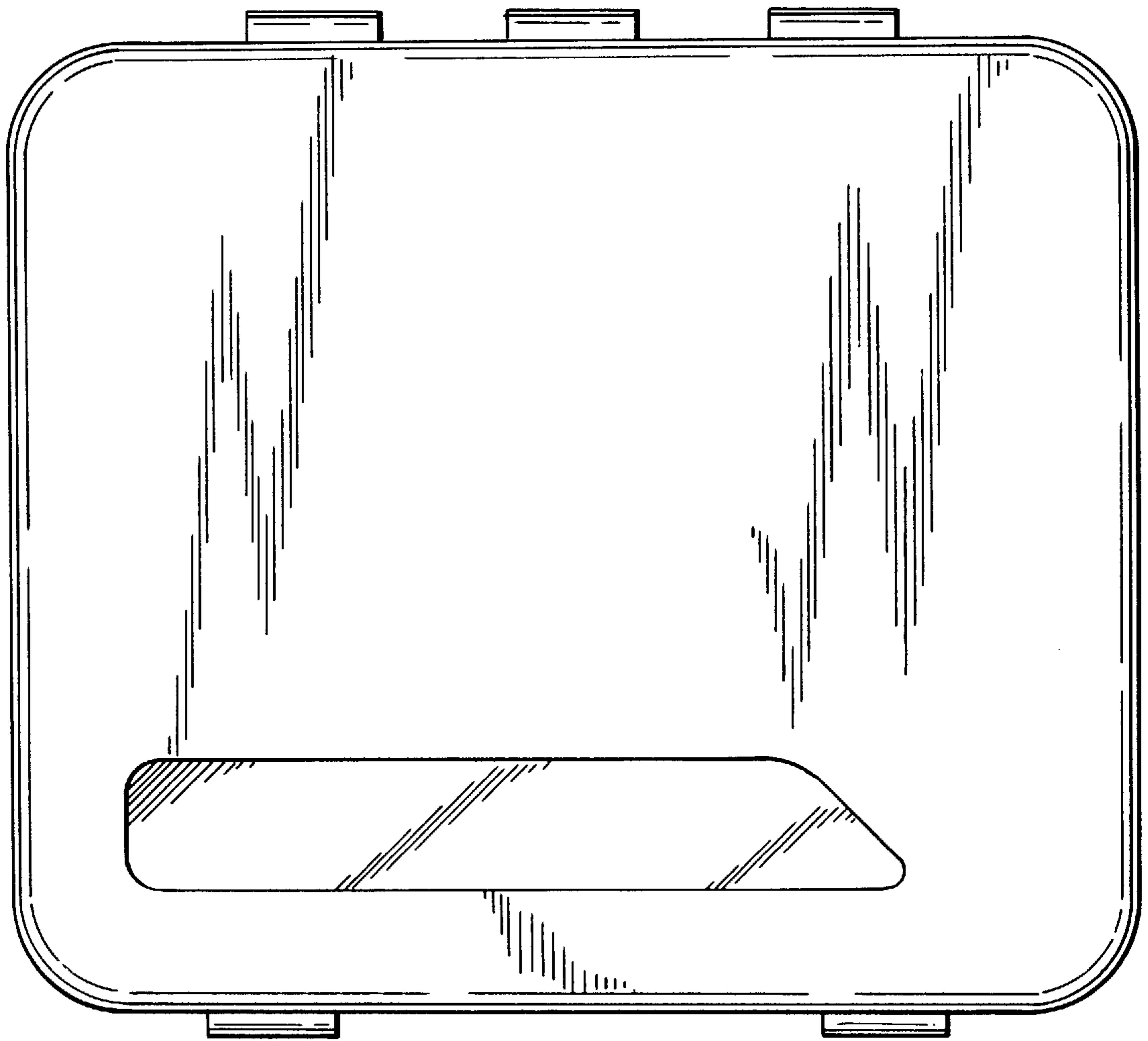

FIG. 13

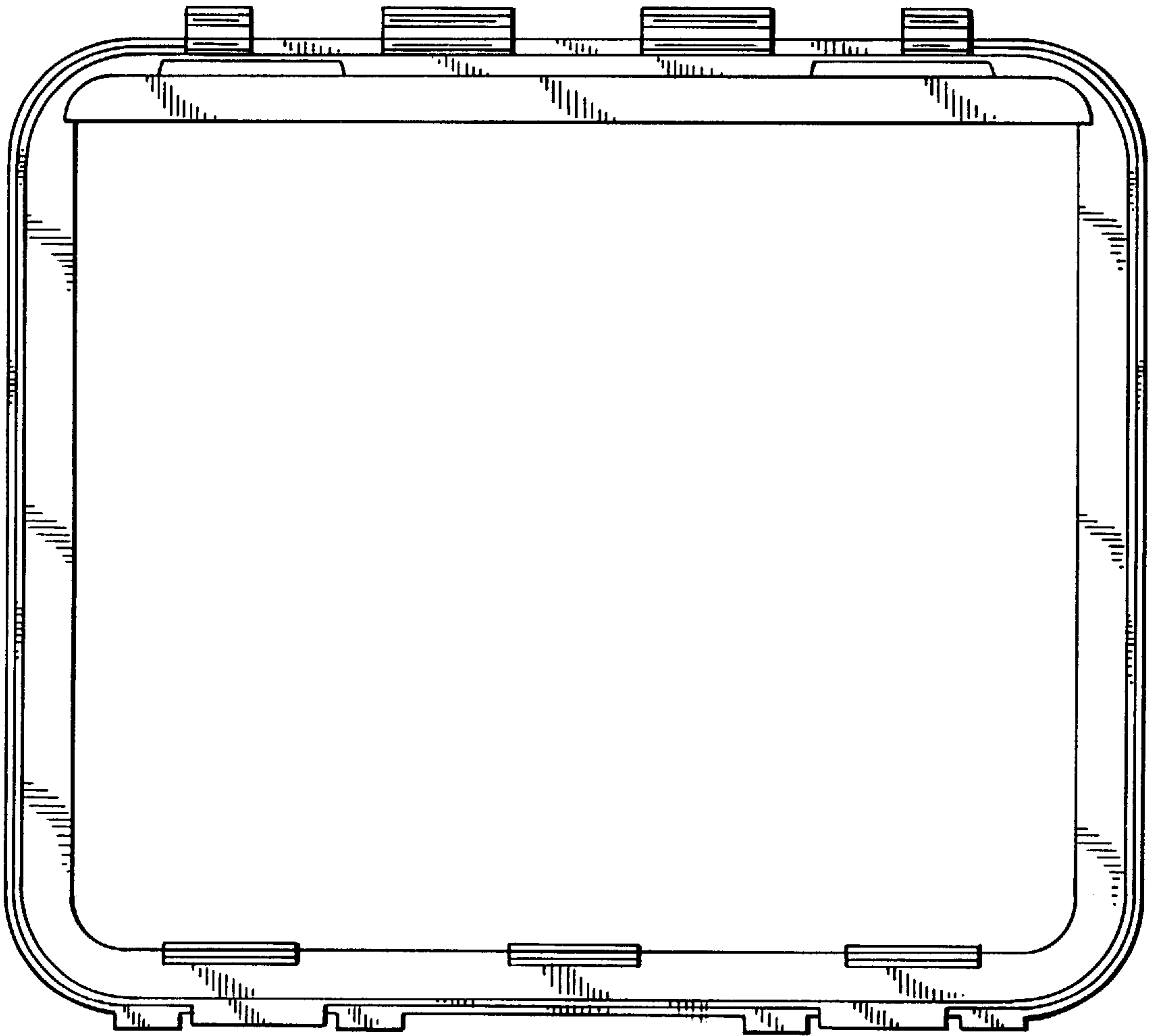

FIG. 14

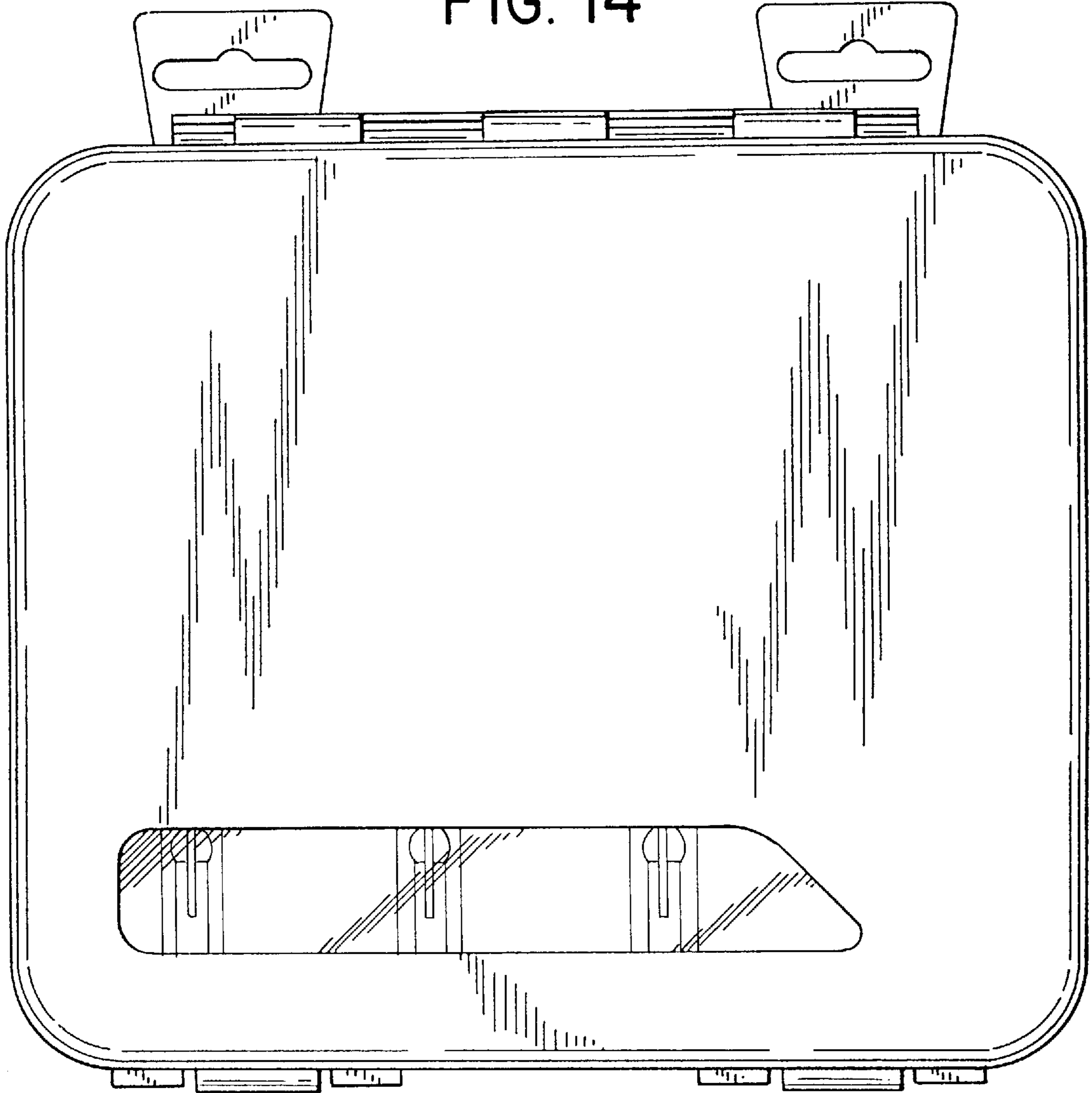

FIG. 15

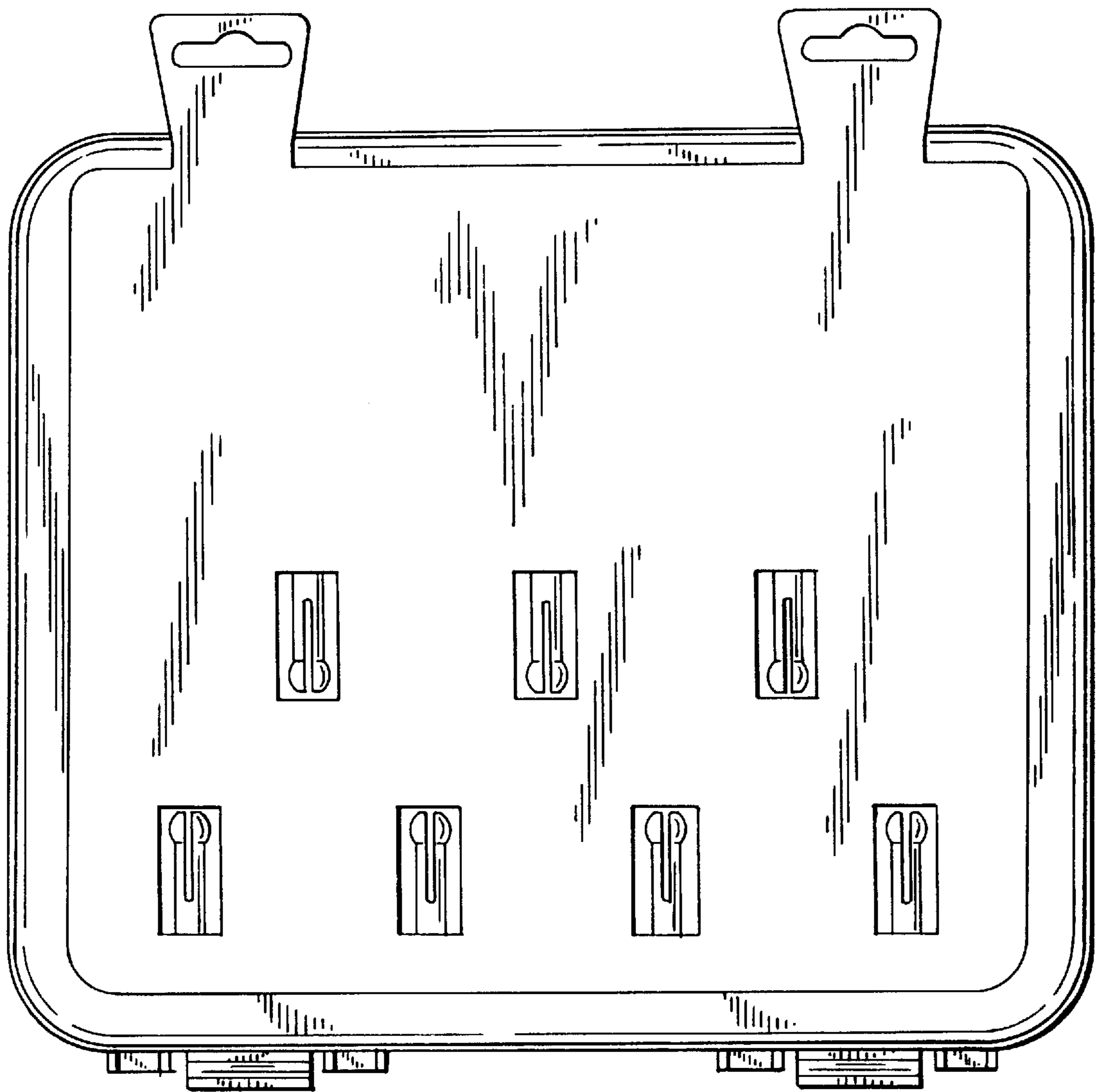

FIG. 16

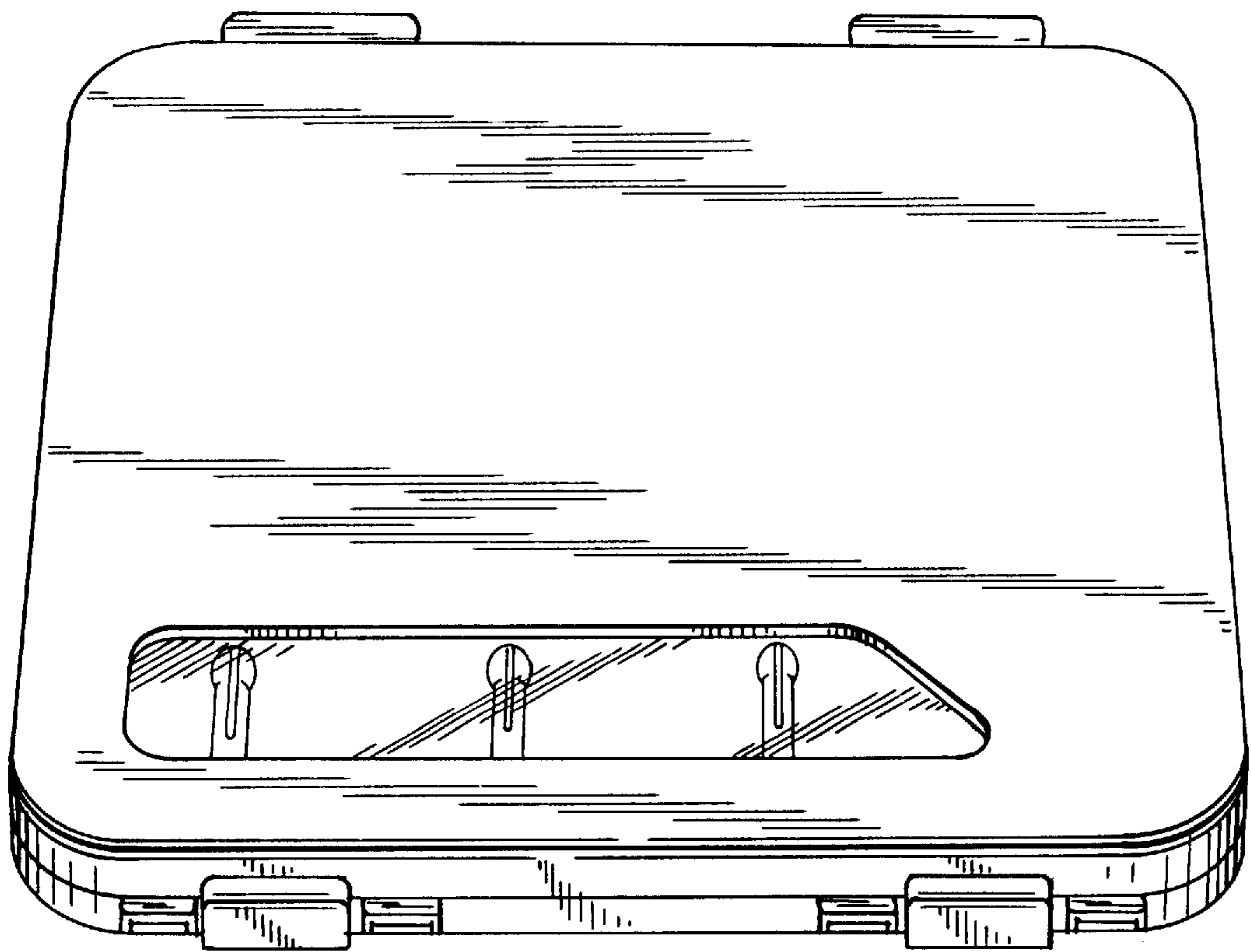

FIG. 17

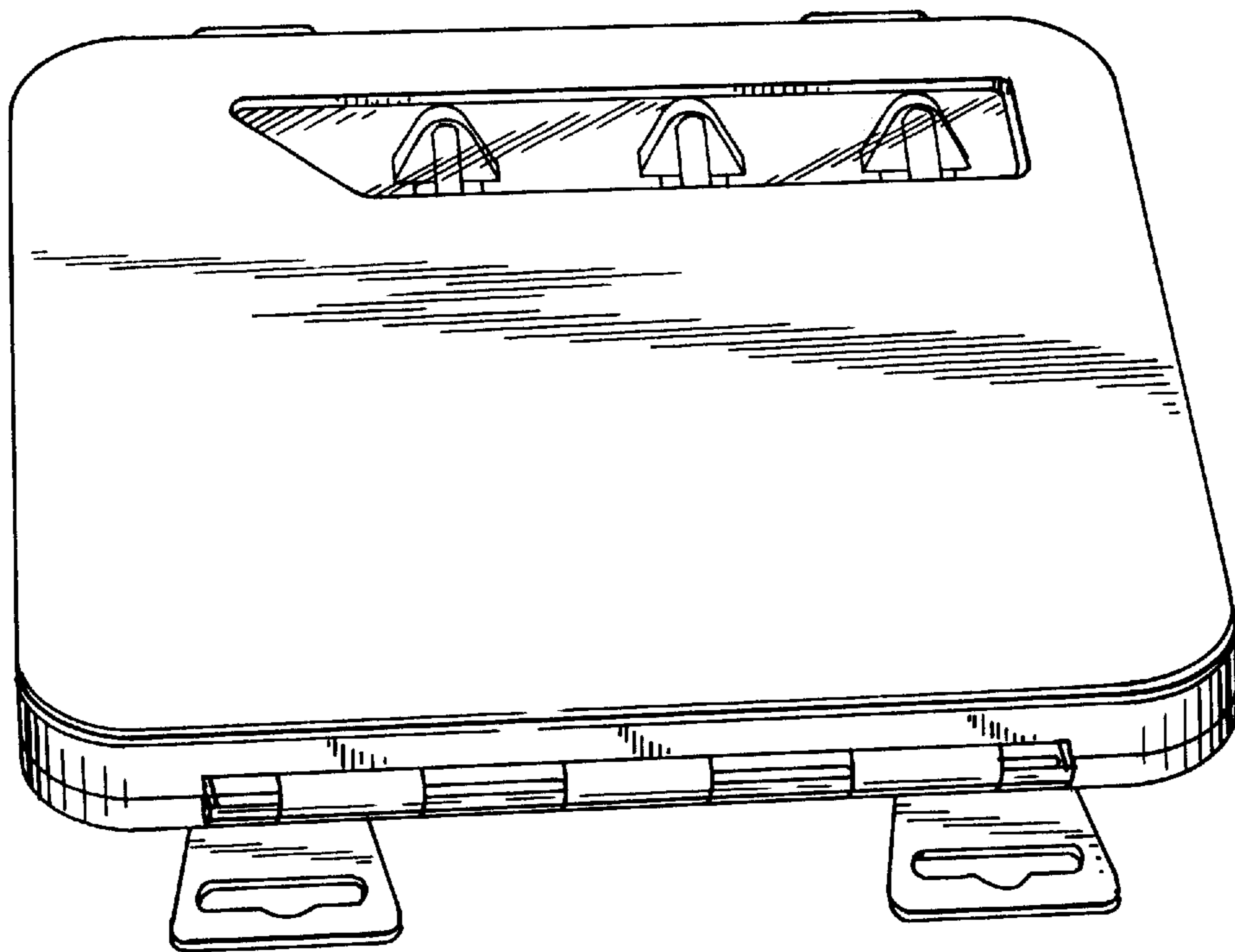

FIG. 18

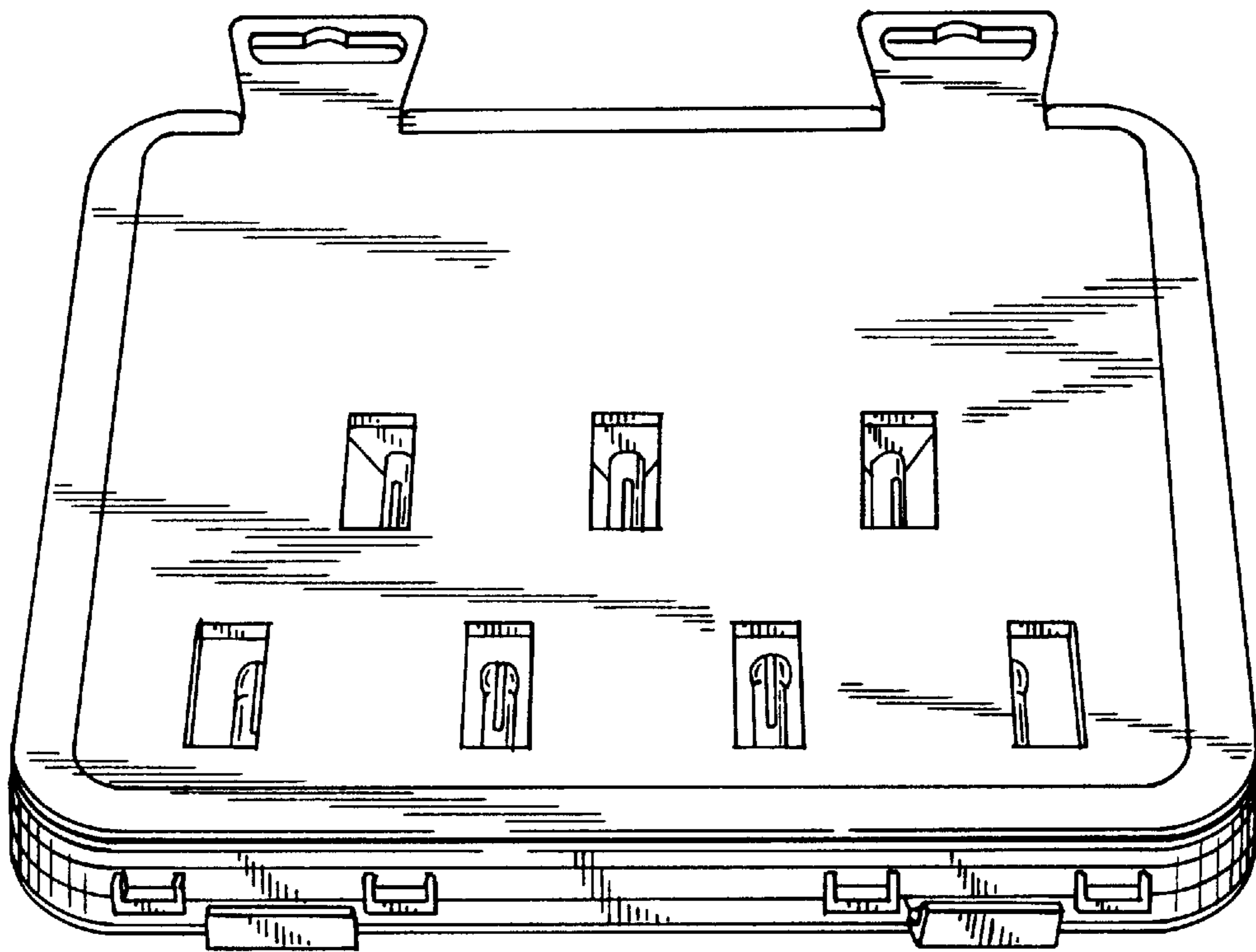



FIG. 19

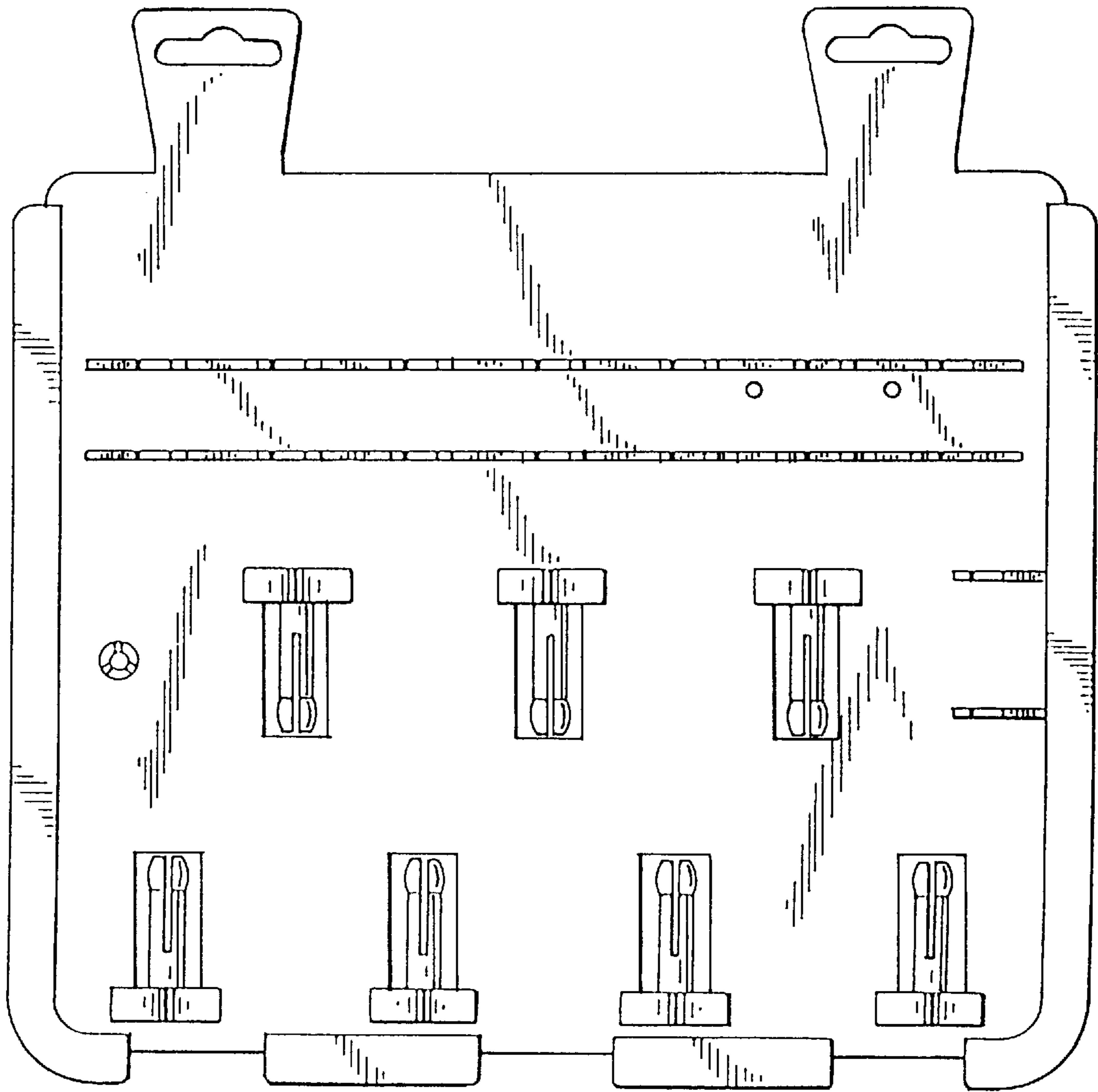

FIG. 20

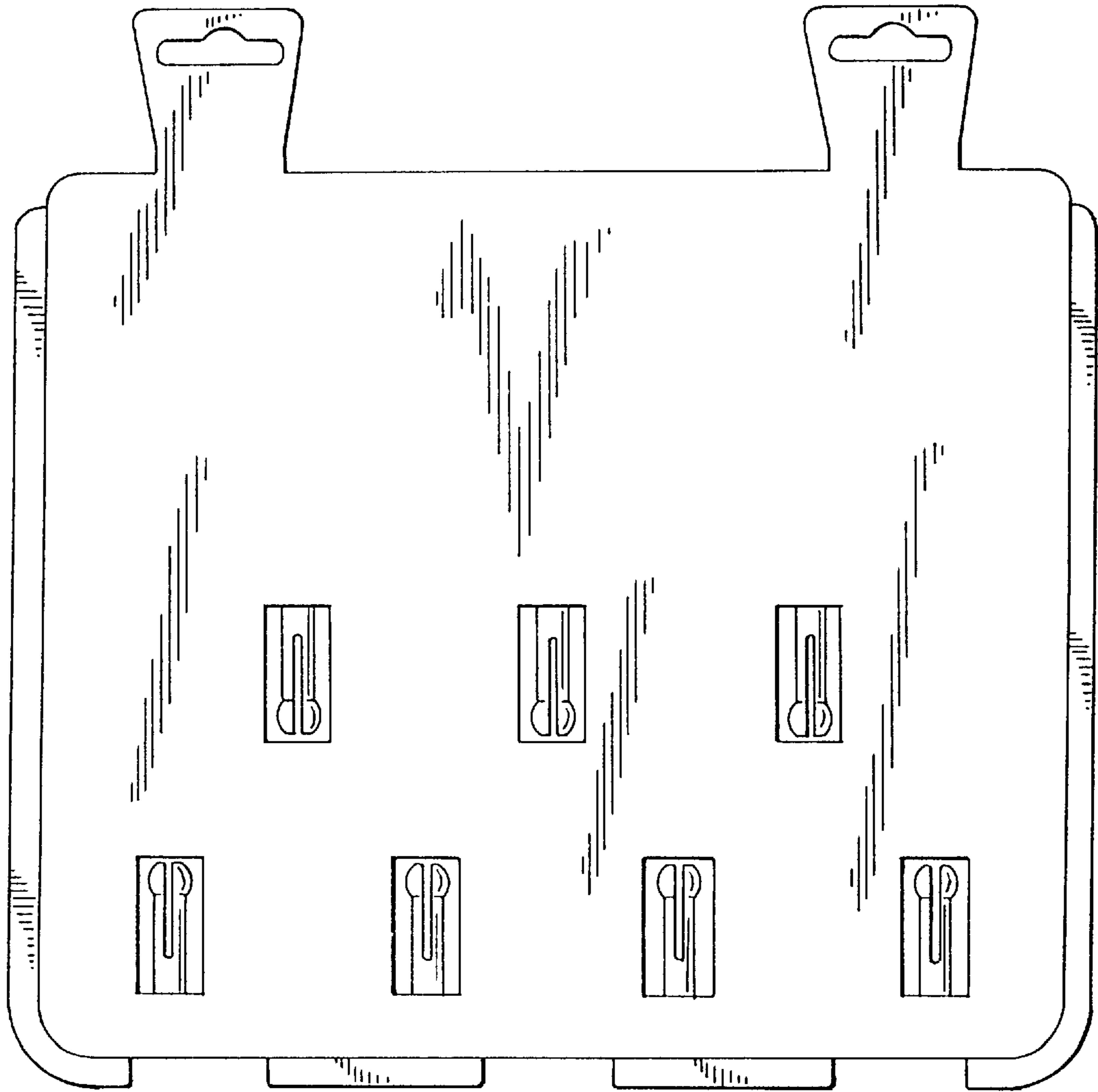

FIG. 21

