



US00D403462S

United States Patent [19] de Longcamp

[11] Patent Number: Des. 403,462

[45] Date of Patent: **Dec. 29, 1998

[54] FLOOR LAMP

[75] Inventor: Gerard de Longcamp, Nantes, France

[73] Assignee: Radian, S.A., Bouaye, France

[**] Term: 14 Years

[21] Appl. No.: 75,199

[22] Filed: Jul. 28, 1997

[51] LOC (6) Cl. 26-05

[52] U.S. Cl. D26/107

[58] Field of Search D26/93, 102-112;
362/410-414

[56] **References Cited**

U.S. PATENT DOCUMENTS

- D. 377,993 2/1997 Herst et al. 26/107 D
- 5,276,597 1/1994 Herst et al. 362/414 X

Primary Examiner—Susan J. Lucas
Attorney, Agent, or Firm—Hill & Simpson

[57] **CLAIM**

The ornamental design for a floor lamp, as shown.

DESCRIPTION

FIG. 1 is a right, front perspective view of the floor lamp showing my new design;
 FIG. 2 is an enlarged bottom, left, and rear view of the head of the lamp, the opposite side being a mirror image;
 FIG. 3 is an enlarged fragmentary rear perspective view of the stand, the opposite side of the stand being a mirror image of the side shown;
 FIG. 4 is a right, front perspective view of a second embodiment of the floor lamp showing my new design;
 FIG. 5 is a bottom, left, and rear view of the head of the lamp, the opposite side being a mirror image; and,
 FIG. 6 is a top perspective view of the head of the lamp which is common to both embodiments.
 The stand in FIGS. 2, and 5 is omitted for convenience of illustration and purposes of disclosure The head of the lamp is omitted from FIG. 3 for purposes of disclosure.

1 Claim, 2 Drawing Sheets

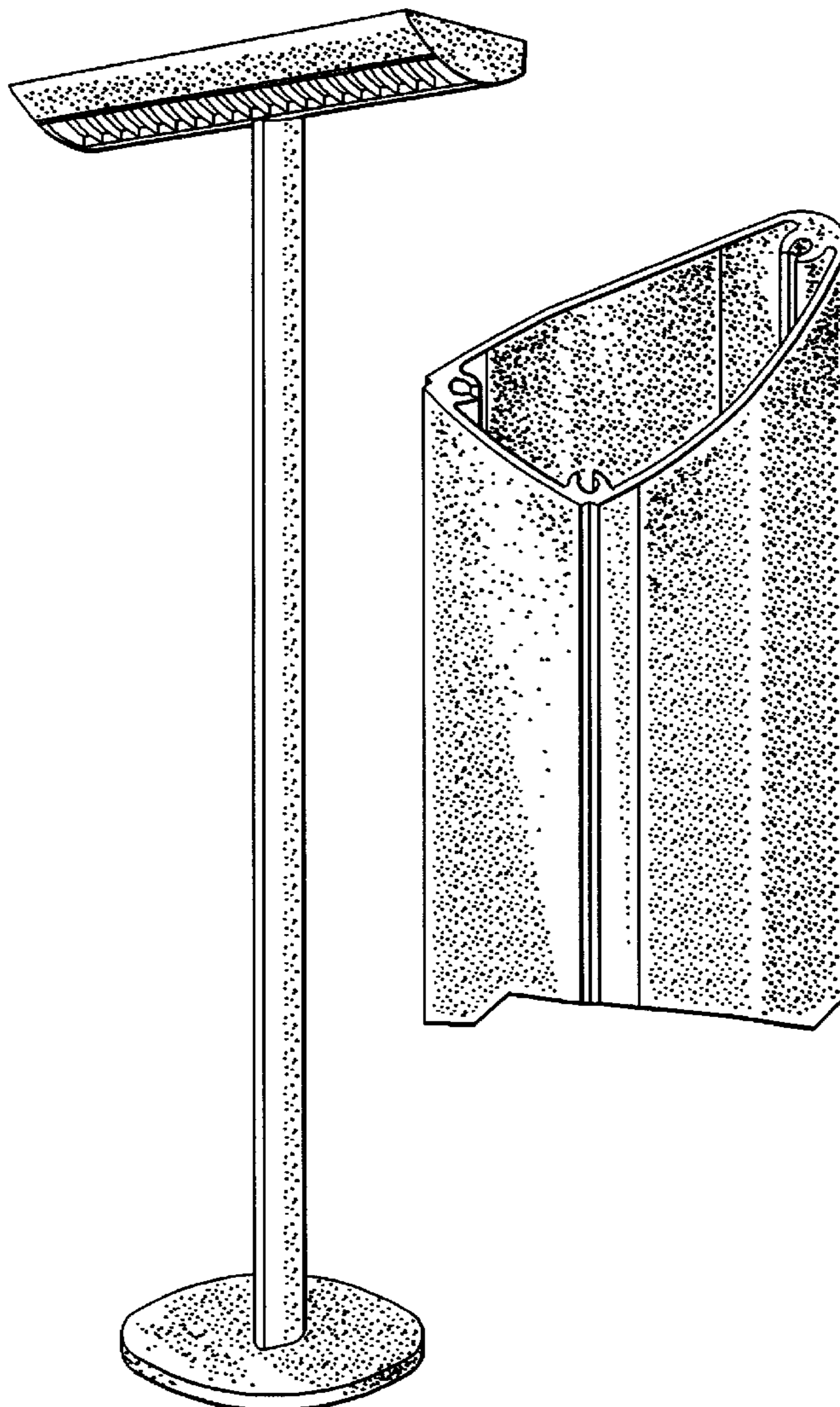

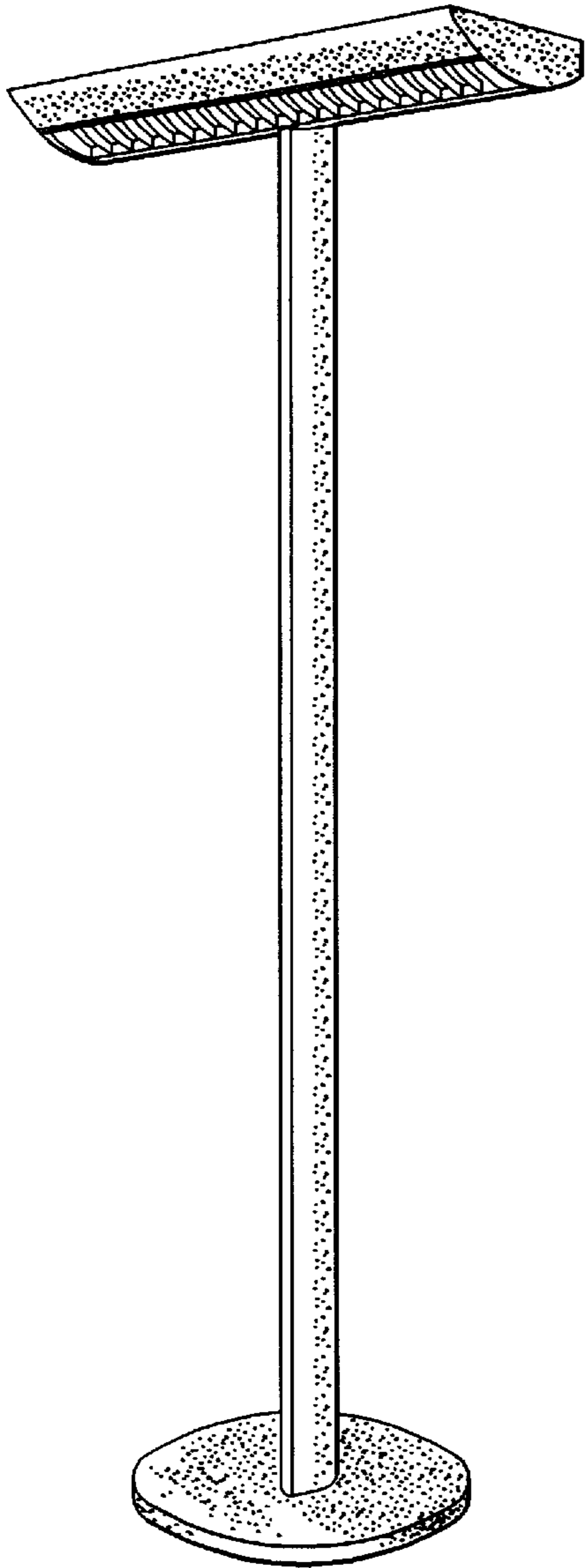

FIG. 1

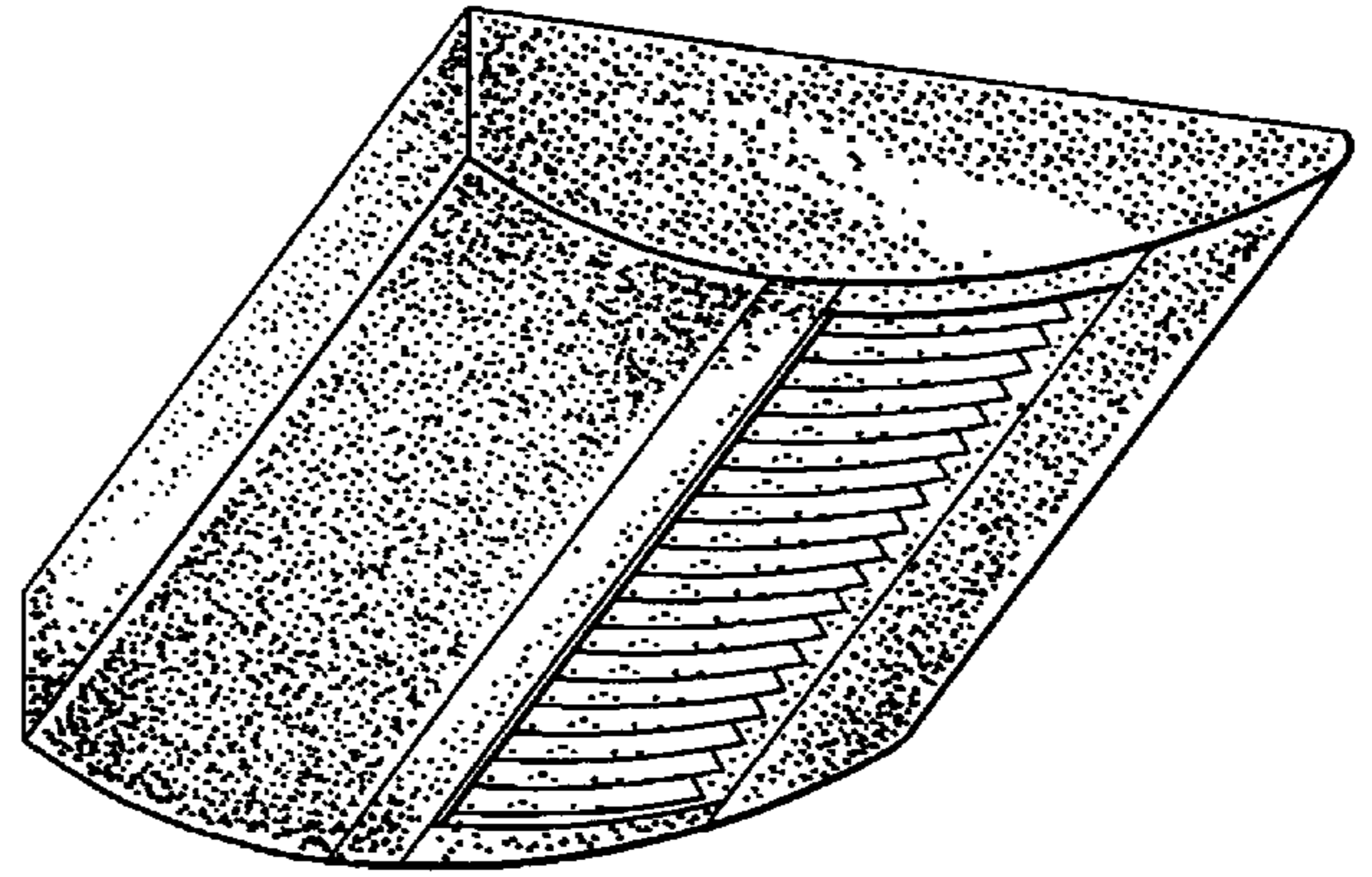

FIG. 2

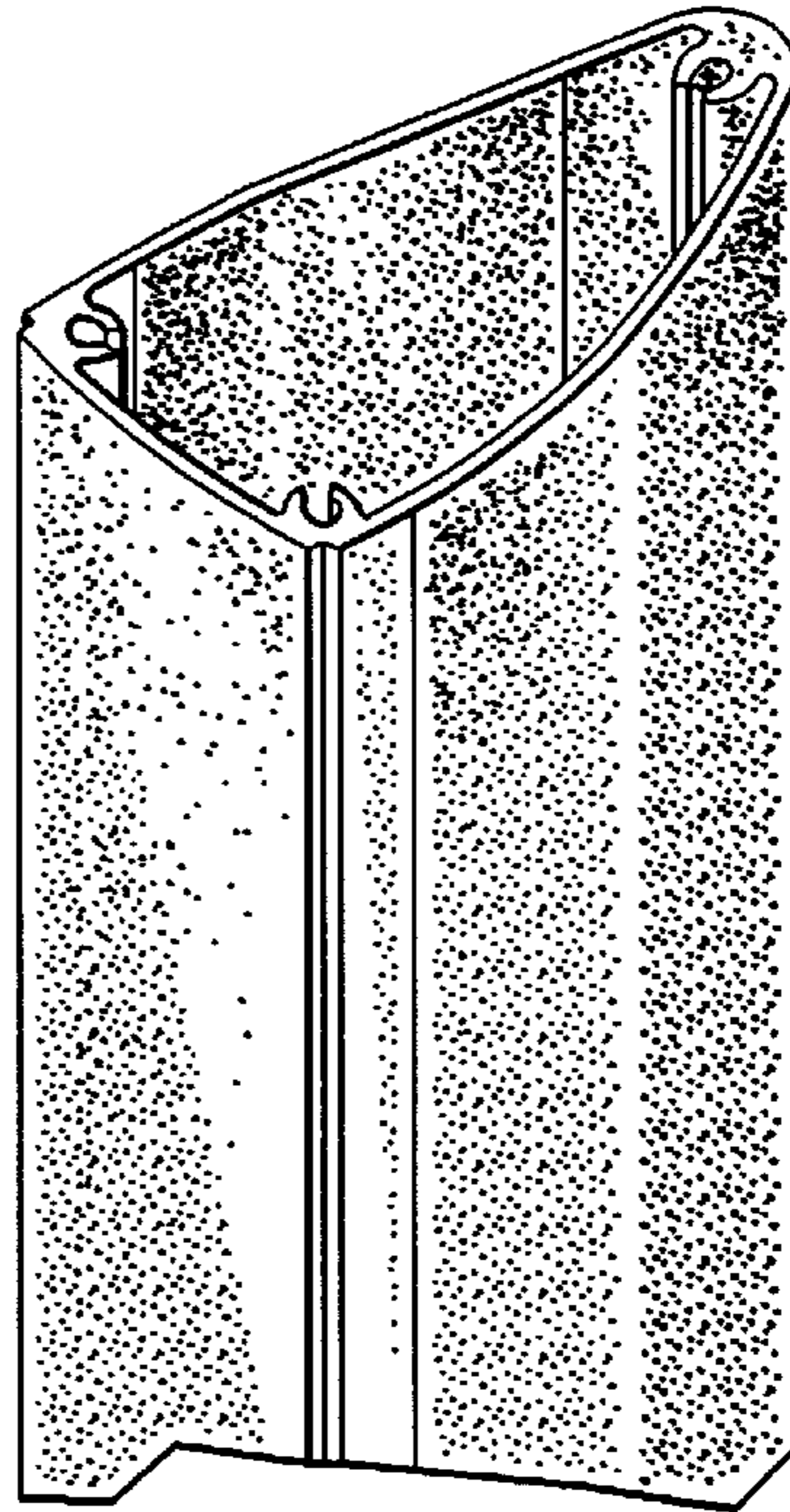

FIG. 3

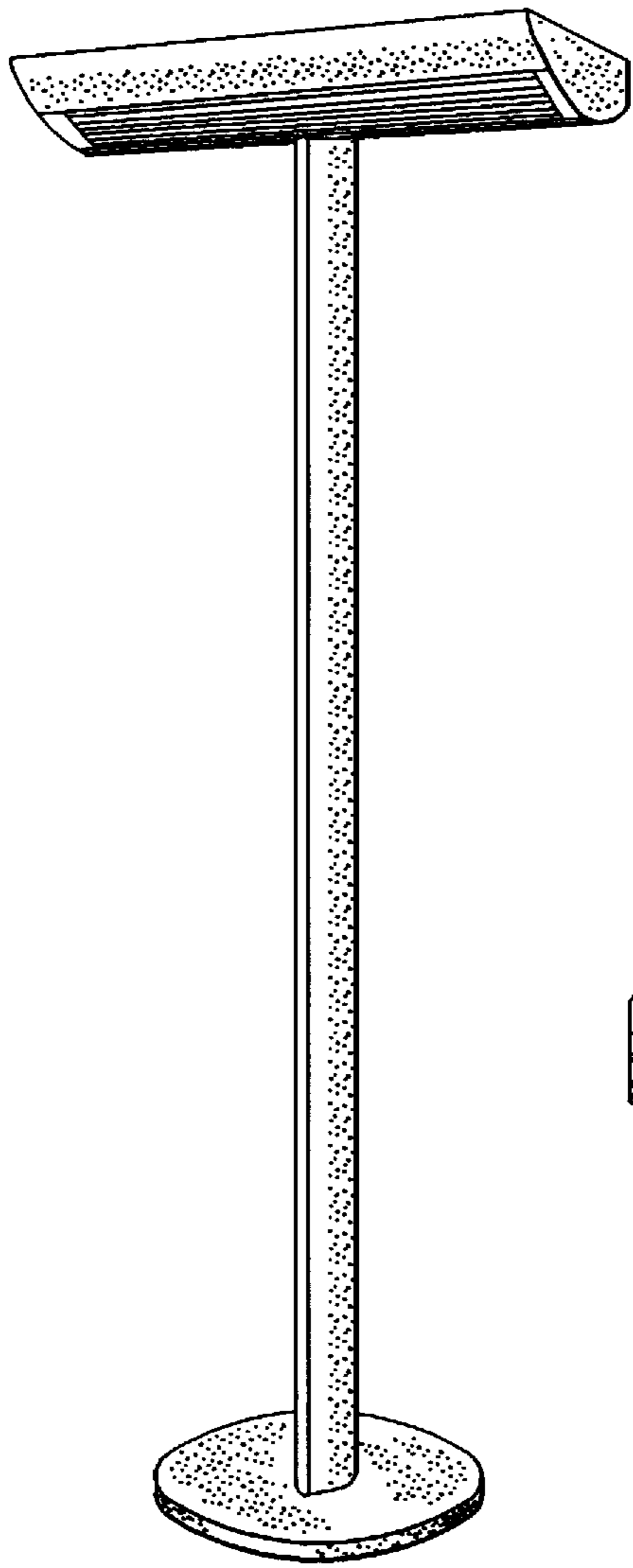

FIG. 4

FIG. 5

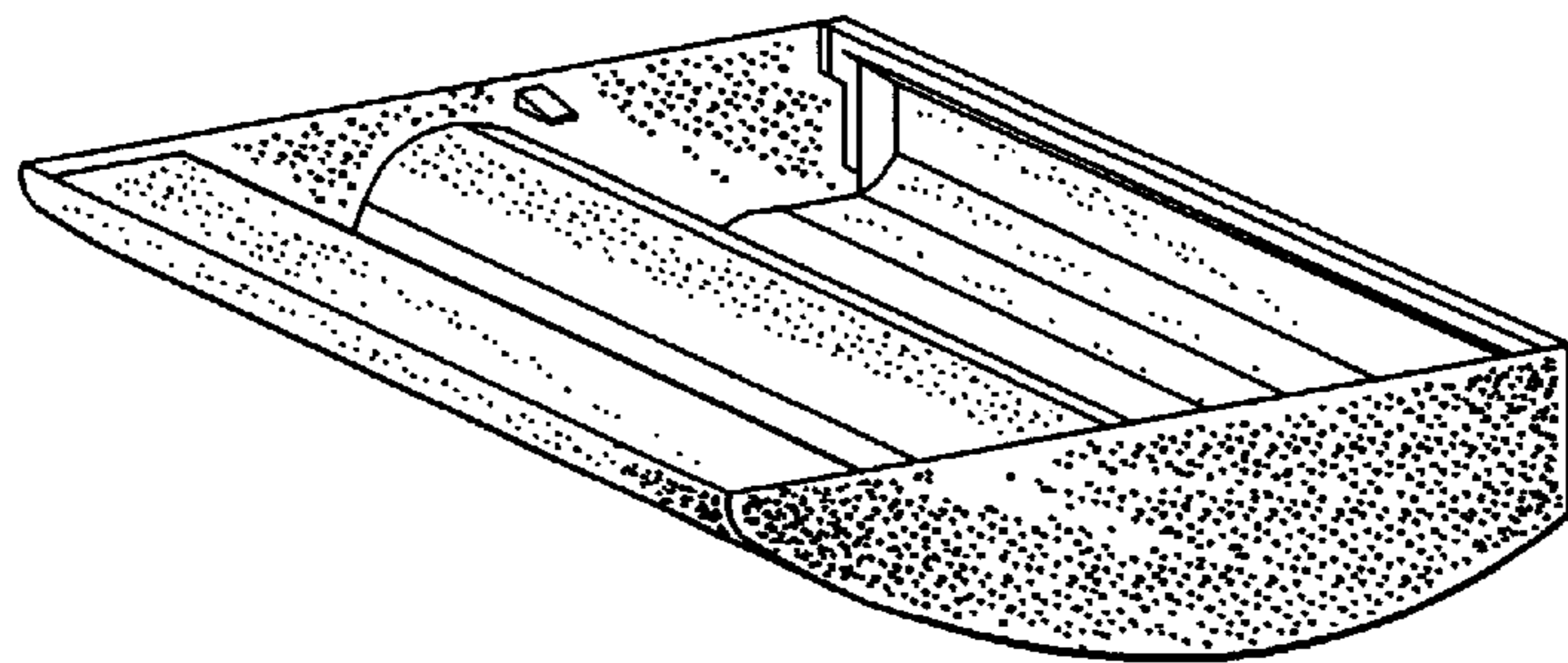
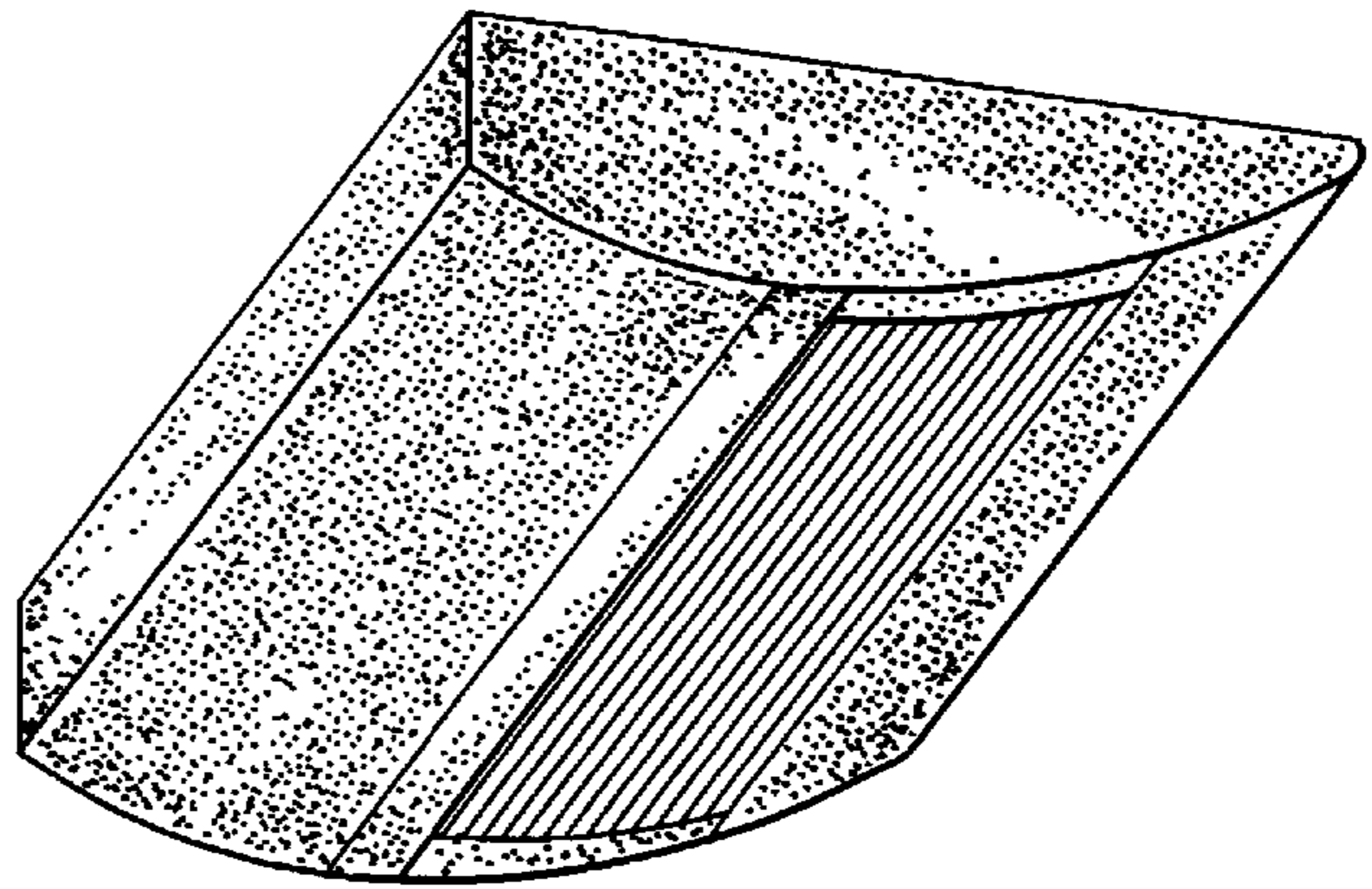

FIG. 6