



US00D403353S

United States Patent [19]

Uchiyama et al.

[11] Patent Number: **Des. 403,353**

[45] Date of Patent: ****Dec. 29, 1998**

[54] **TAPE CARTRIDGE FOR TAPE PRINTER**

[75] Inventors: **Yoichi Uchiyama**, Nagoya; **Koshiro Yamaguchi**, Kasugai; **Kiyoshi Sugimoto**, Kuwana, all of Japan

[73] Assignee: **Brother Kogyo Kabushiki Kaisha**, Nagoya, Japan

[**] Term: **14 Years**

[21] Appl. No.: **68,500**

[22] Filed: **Mar. 24, 1997**

Related U.S. Application Data

[62] Division of Ser. No. 52,848, Apr. 10, 1996, Pat. No. Des. 389,179.

[30] Foreign Application Priority Data

Nov. 8, 1995	[JP]	Japan	7-33887
Nov. 8, 1995	[JP]	Japan	7-33888
Nov. 8, 1995	[JP]	Japan	7-33889

[51] **LOC (6) Cl.** **18-02**

[52] **U.S. Cl.** **D18/56**

[58] **Field of Search** D18/56; D14/121; 400/235.1, 207, 208, 234, 612

4,650,354	3/1987	Morarka et al. .	
4,844,636	7/1989	Paque .	
4,880,323	11/1989	Milliser et al. .	
5,215,012	6/1993	Kannoe et al.	D18/56
5,295,753	3/1994	Godou et al.	400/612
5,383,733	1/1995	Zinsmeyer et al. .	
5,431,504	7/1995	Beadman et al.	400/234
5,435,658	7/1995	Hasegawa	400/208
5,439,303	8/1995	Alday	D18/56
5,500,669	3/1996	Yamashita et al.	D18/56
5,533,818	7/1996	Bahrabadi	400/208
5,567,065	10/1996	Cai et al.	400/207
5,569,064	10/1996	Yeong	400/235.1
5,601,375	2/1997	Sims et al.	400/207
5,618,119	4/1997	Misu et al.	400/208
5,620,268	4/1997	Yamaguchi et al.	400/207

FOREIGN PATENT DOCUMENTS

061577	10/1982	European Pat. Off. .	
0 075 665	4/1983	European Pat. Off. .	
2591150	6/1987	France	400/234
3510303	9/1986	Germany .	
3927421	2/1991	Germany .	
0 134 775	8/1983	Japan .	
0134777	8/1983	Japan .	
4008077	1/1989	Japan .	
5330210	12/1993	Japan .	
6115234	4/1994	Japan .	
6143777	5/1994	Japan .	
6166251	6/1994	Japan .	

[56] References Cited

U.S. PATENT DOCUMENTS

D. 253,354	11/1979	Lenney et al. .	
D. 284,978	8/1986	Kusabuka .	
D. 342,275	12/1993	Cooper	D18/56
D. 347,241	5/1994	Watanabe et al. .	
D. 352,305	11/1994	Cooper	D18/56
D. 355,671	2/1995	Onumata	D18/56
D. 357,497	4/1995	Gray et al.	D18/56
D. 358,601	5/1995	Zinsmeyer .	
D. 359,303	6/1995	Gray et al. .	
D. 372,044	7/1996	Ware et al. .	
D. 372,269	7/1996	Miyazaki et al.	D18/56
D. 376,796	12/1996	Hirasawa	D18/56
3,804,227	4/1974	Cappotto et al. .	
4,074,799	2/1978	Hishida et al. .	
4,480,936	11/1984	Kasun et al. .	
4,582,439	4/1986	LaSpesa .	

OTHER PUBLICATIONS

IBM Technical Disclosure Bulletin; vol. 25, No. 10; Mar. 1983; Stuffer Gear Drive.
OPD/Feb. 1980; p. 95; Graphic Ribbon, Inc. advertisement; center tape cartridge, bottom row.

Primary Examiner—Cathy Anne MacCormac
Attorney, Agent, or Firm—Oliff & Berridge, PLC

[57] CLAIM

The ornamental design for a tape cartridge for tape printer, as shown and described.

DESCRIPTION

FIG. 1 is a top plan view of a tape cartridge for tape printer; FIG. 2 is a bottom plan view thereof;

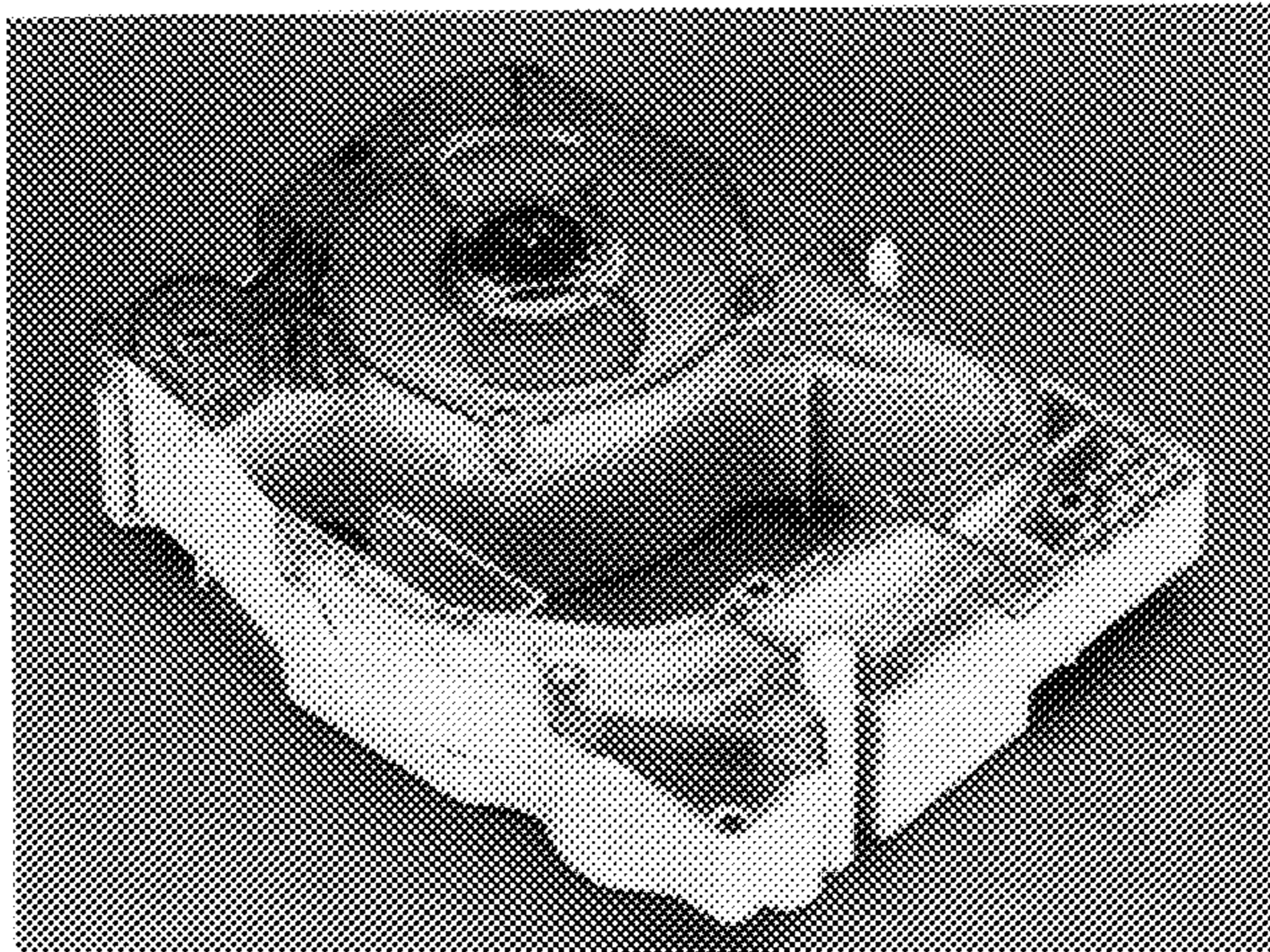

FIG. 3 is a front view thereof;
FIG. 4 is a rear view thereof;
FIG. 5 is a left side view thereof;
FIG. 6 is a right side view thereof; and,
FIG. 7 is a perspective view thereof.

The solid black areas in FIGS. 1-4, 6 and 7 are due to shadows produced during photography. It should also be understood that there is no ornamentation on the interior surfaces.

1 Claim, 4 Drawing Sheets

FIG. 1

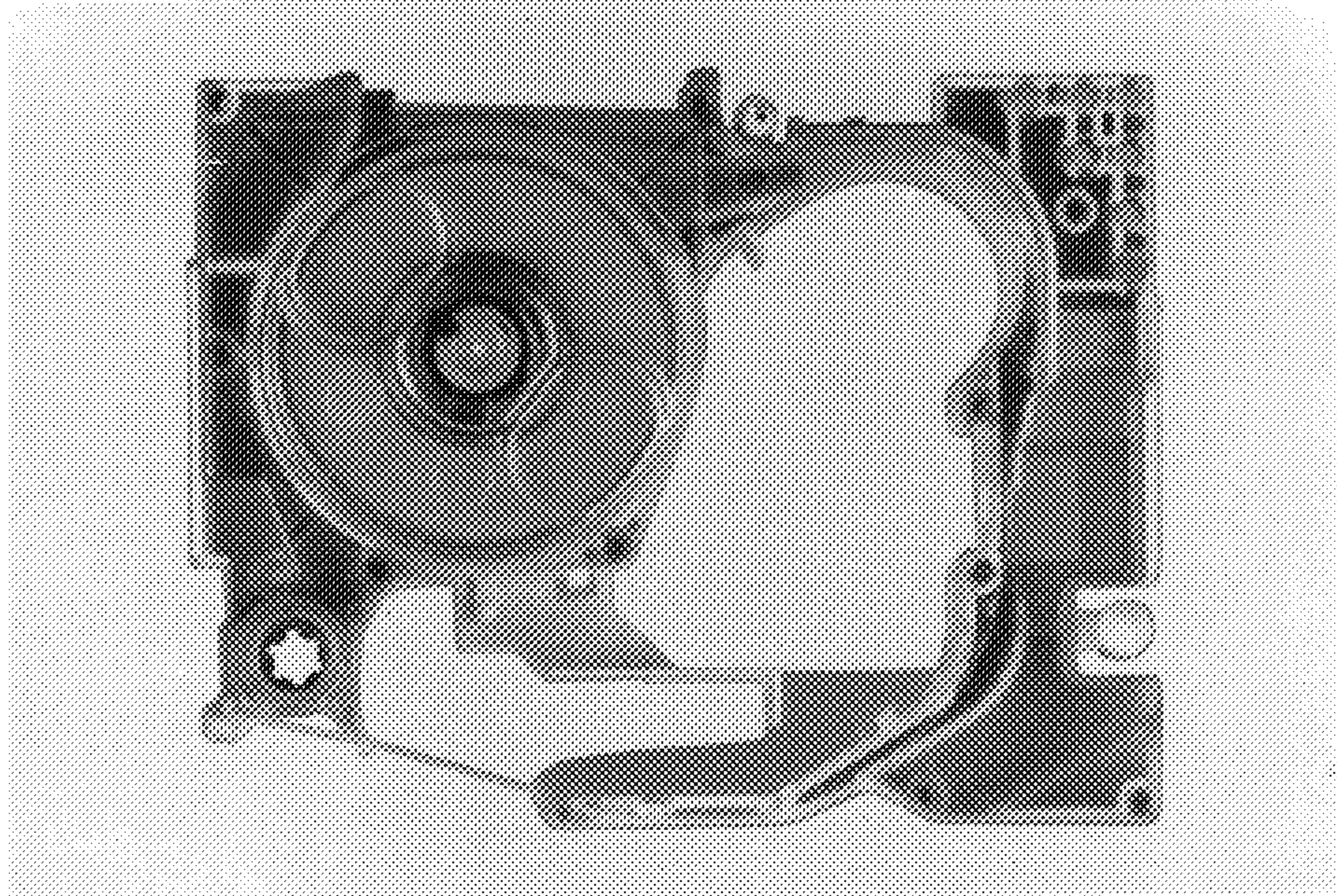

FIG. 2

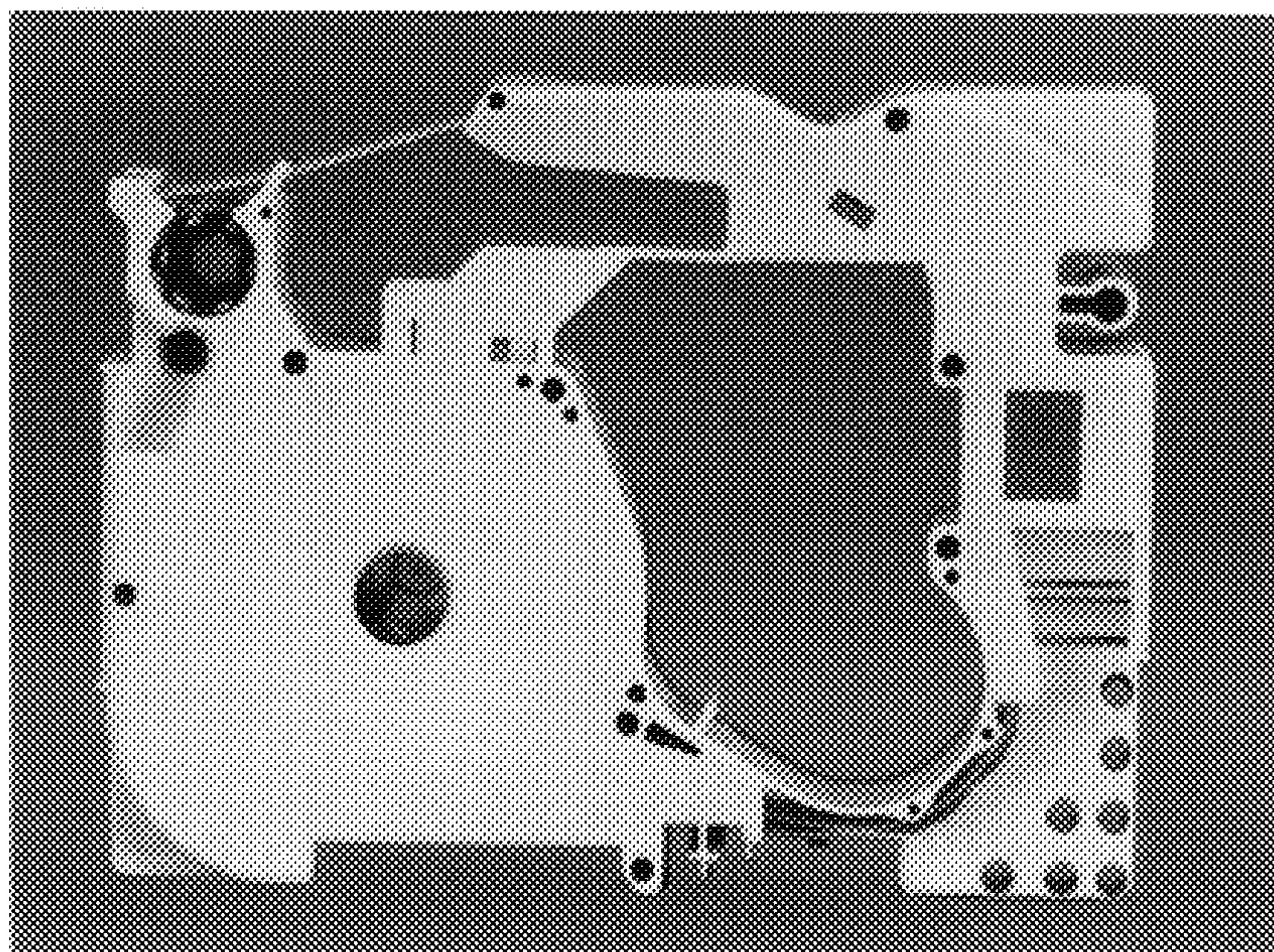

FIG. 3

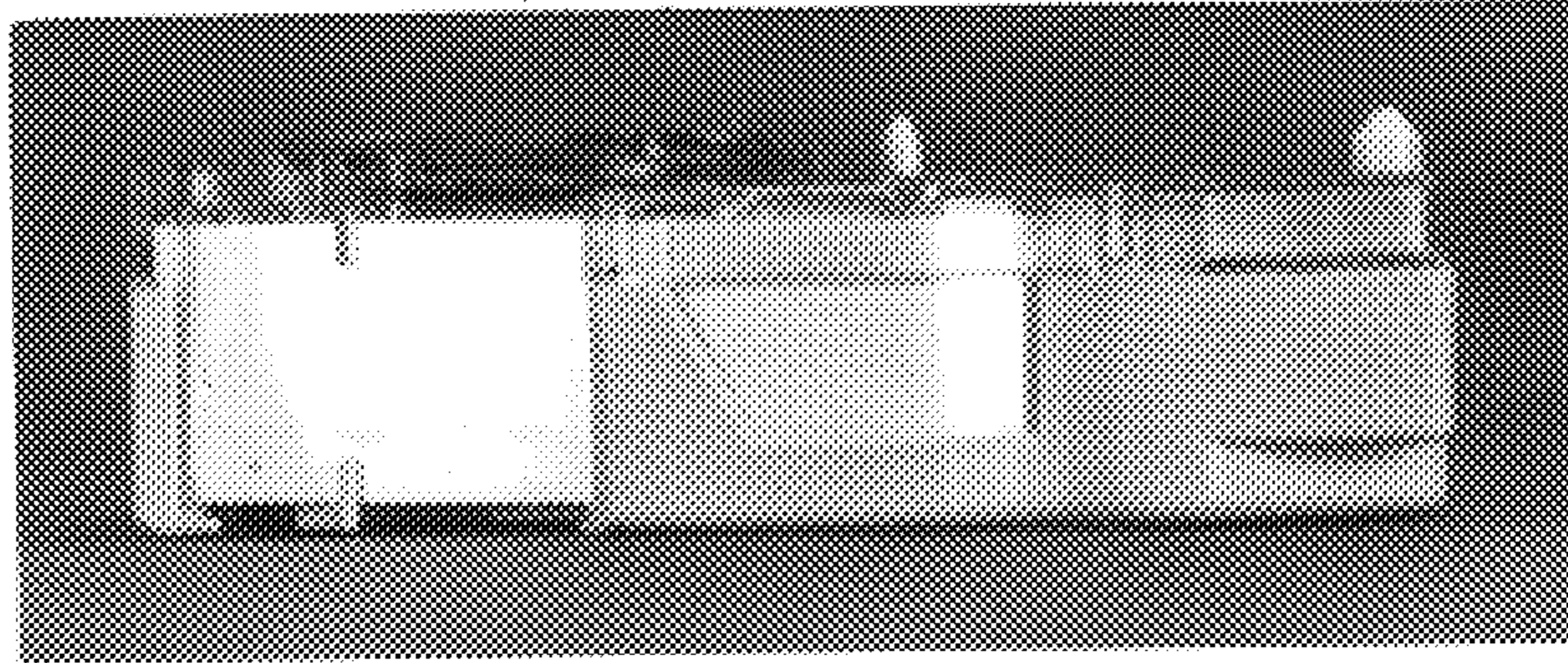

FIG. 4

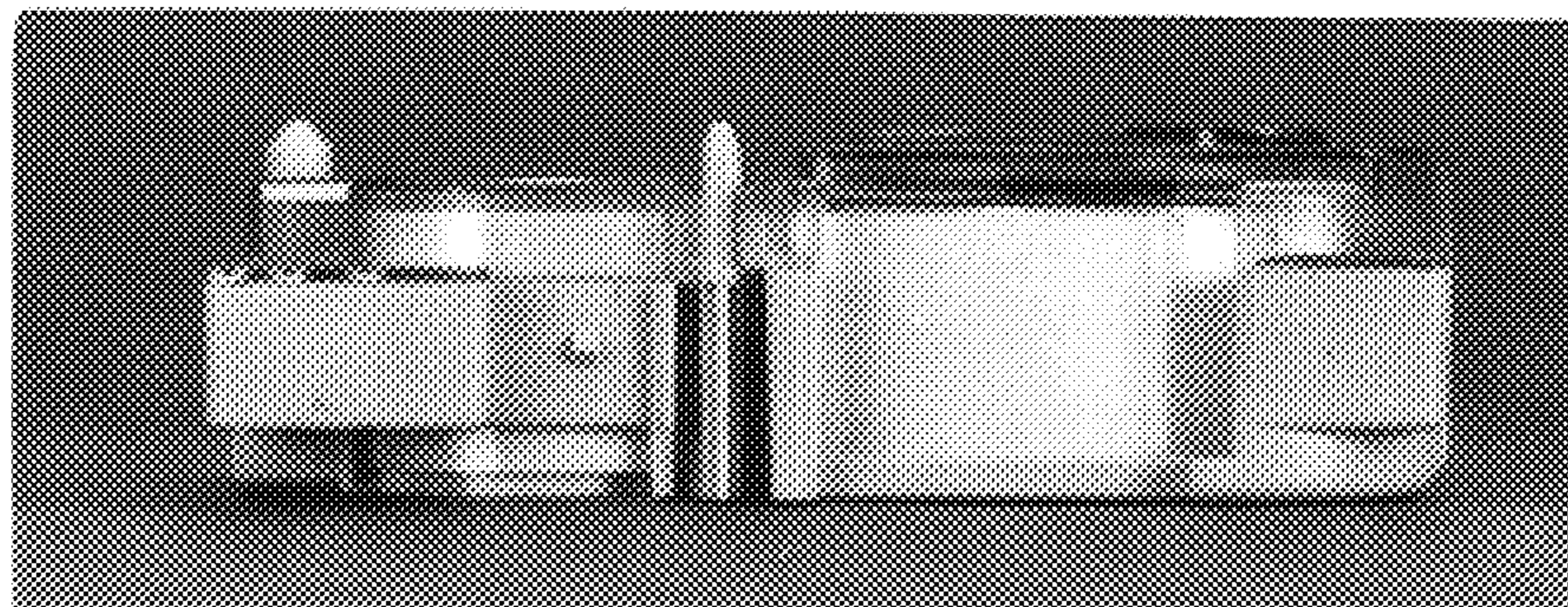

FIG. 5

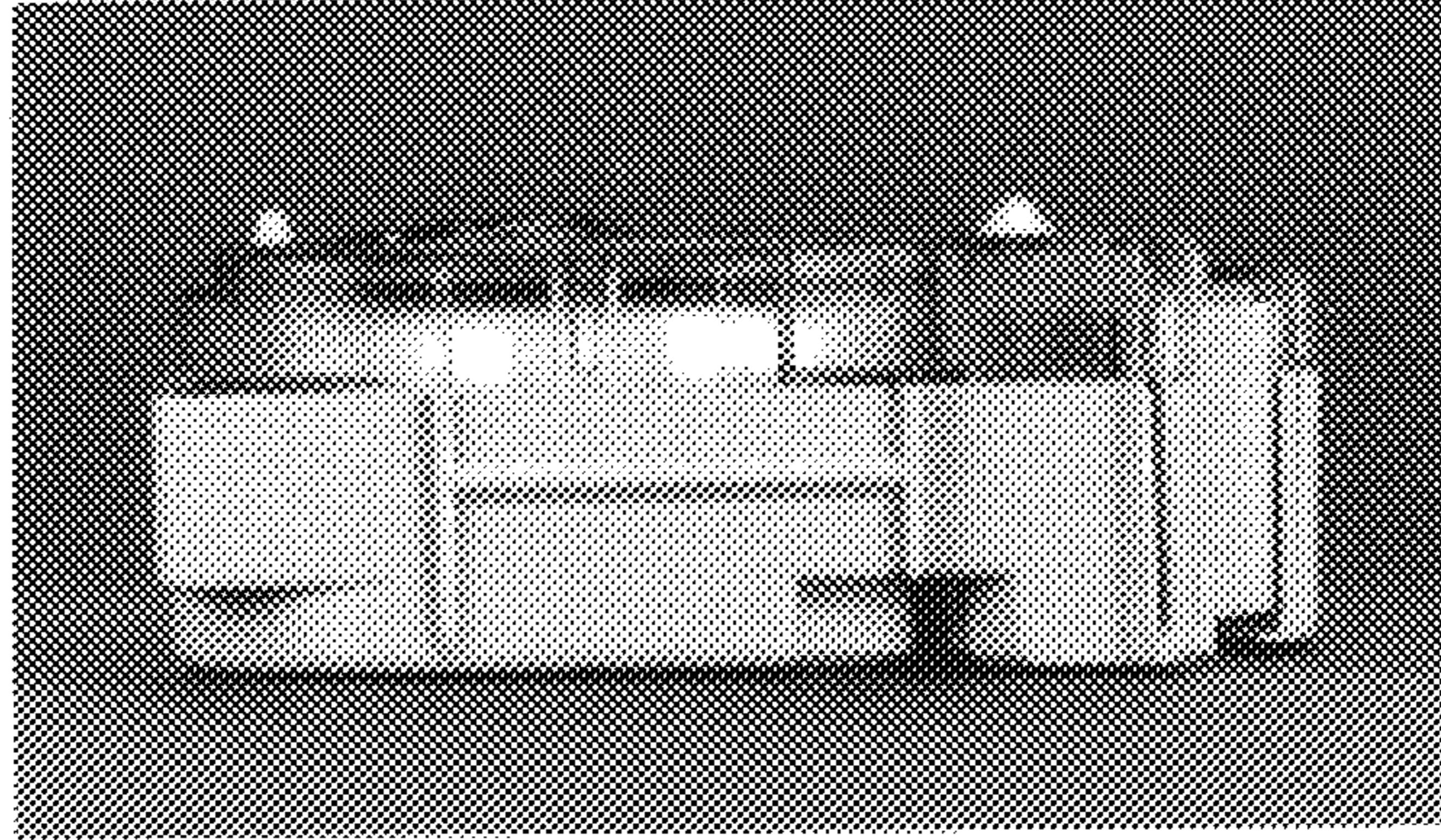

FIG. 6

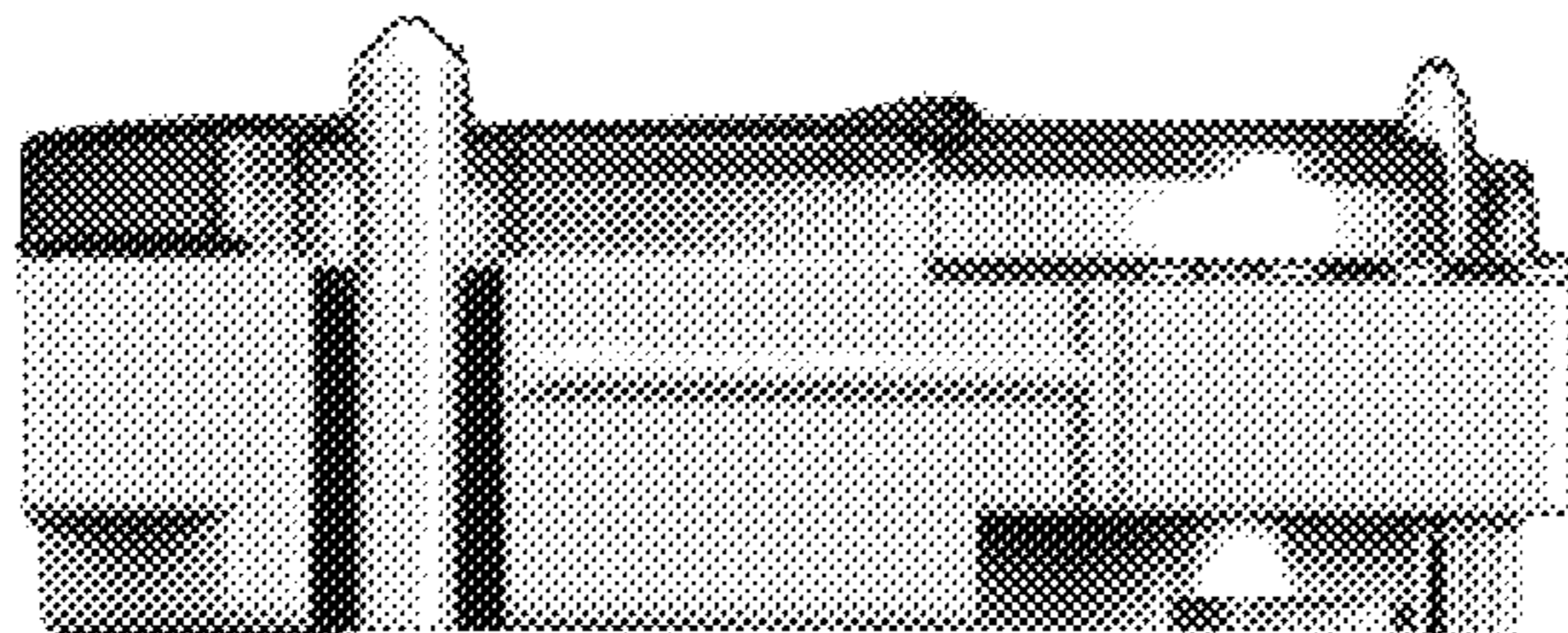

FIG. 7

