

US00D403349S

United States Patent [19]

Hirose et al.

[11] Patent Number: Des. 403,349

[45] Date of Patent: **Dec. 29, 1998

[54] SHEET HANDLING APPARATUS

D. 274,520 7/1984 Bressler D18/49
4,416,449 11/1983 McNerny D18/47 X

[75] Inventors: Tomoyuki Hirose; Toyoaki Nanba;
Kyouzuke Taka, all of Osaka;
Kazuyuki Kubota; Hideki Mimura,
both of Yamanashi-Ken, all of Japan

Primary Examiner—Caron D. Veynar
Attorney, Agent, or Firm—Kane, Dalsimer, Sullivan, Kurucz,
Levy, Eisele and Richard, LLP

[73] Assignees: Sharp Kabushiki Kaisha, Osaka-fu;
Nisca Corporation, Yamanashi-ken,
both of Japan

[57] CLAIM

The ornamental design for a sheet handling apparatus, as shown and described.

[**] Term: 14 Years

DESCRIPTION

[21] Appl. No.: 81,217

FIG. 1 is a front elevational view of a sheet handling apparatus embodying our ornamental design;
FIG. 2 is a top plan view thereof;
FIG. 3 is a right side view thereof;
FIG. 4 is a left side view thereof;
FIG. 5 is a rear view thereof;
FIG. 6 is a bottom plan view thereof;
FIG. 7 is a sectional view taken along lines 7—7 of FIG. 2;
FIG. 8 is a sectional view taken along lines 8—8 of FIG. 2;
FIG. 9 is a view similar to FIG. 1 but depicting elevating trays in a moved position; and,
FIG. 10 is a front perspective view.

[22] Filed: Dec. 23, 1997

[51] LOC (6) Cl. 18-99

[52] U.S. Cl. D18/46; D18/47

[58] Field of Search D18/36-40, 46-49;
399/361, 367, 369; 271/3.14, 8.1, 278,
279, 287

[56] References Cited

U.S. PATENT DOCUMENTS

D. 264,847 6/1982 DiBlasio D18/46

1 Claim, 10 Drawing Sheets

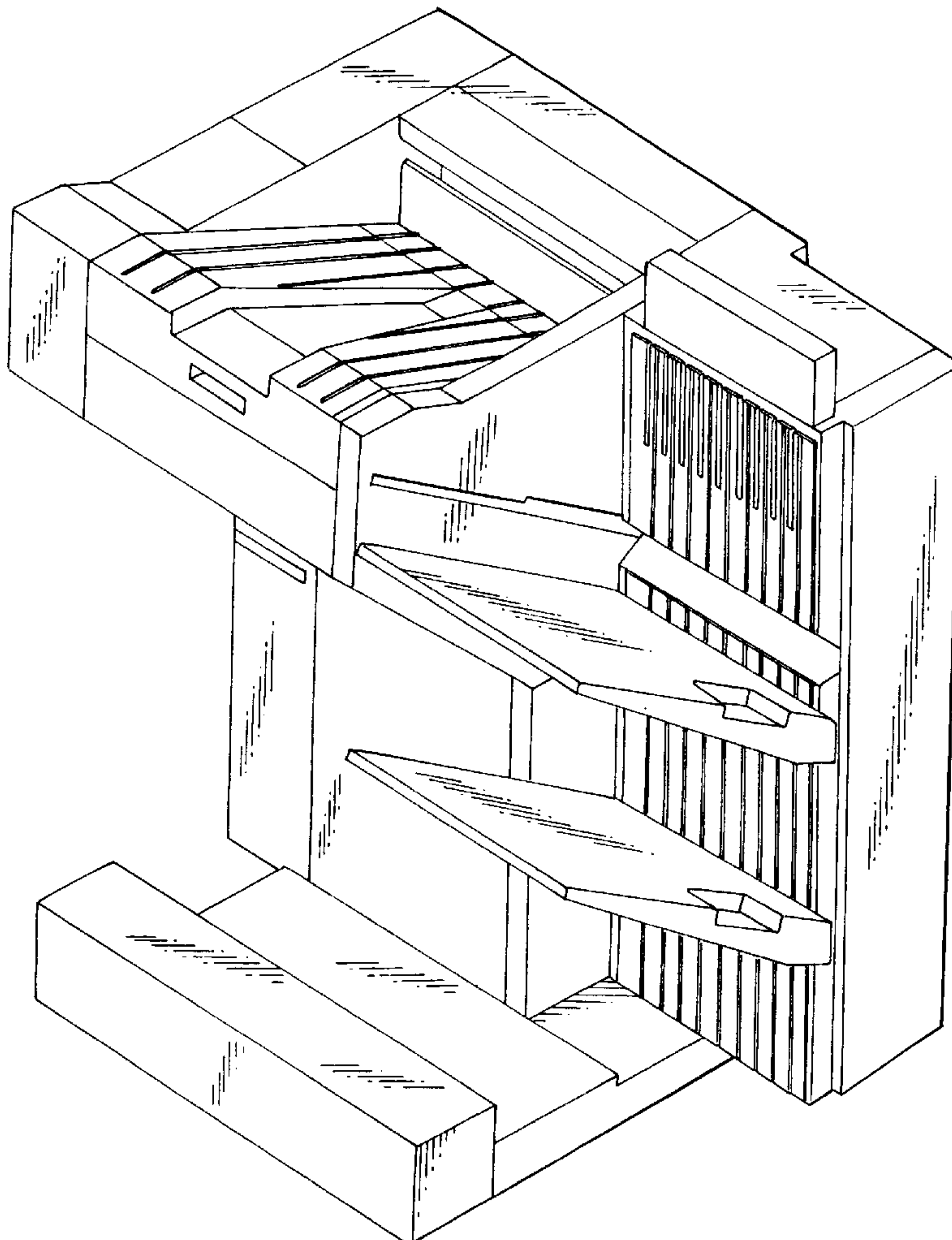

FIG. 1

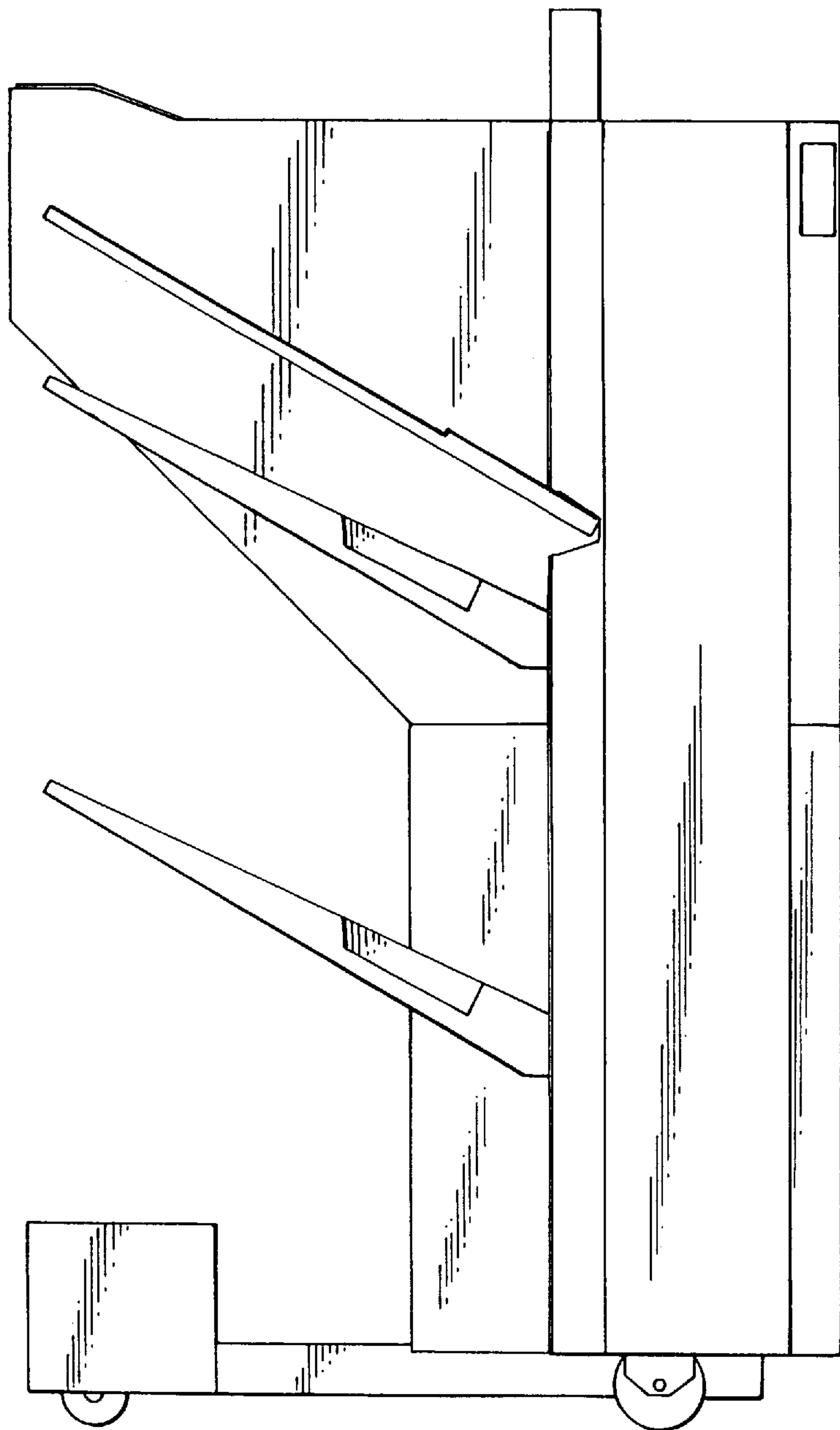

FIG. 2

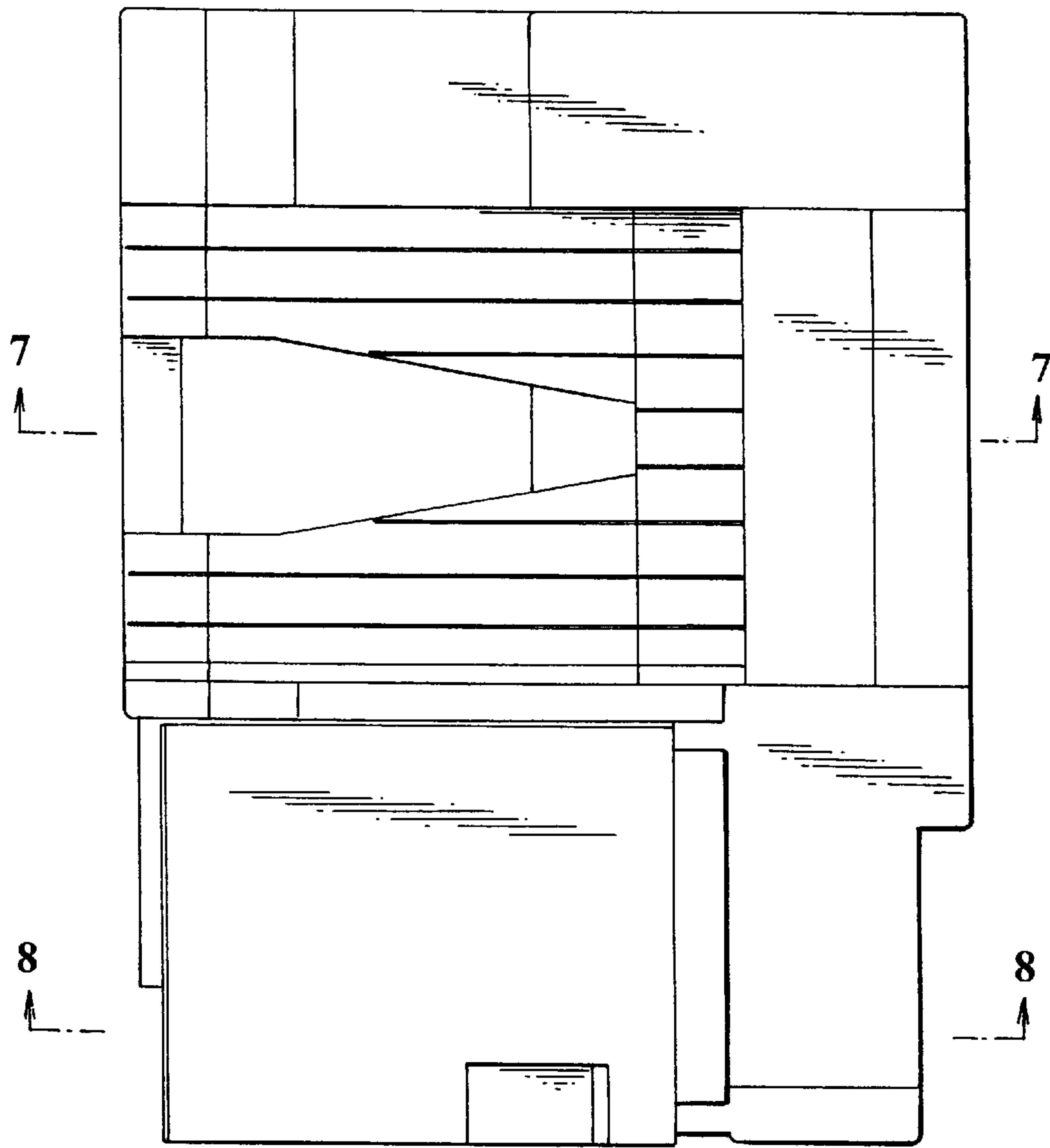

FIG. 3

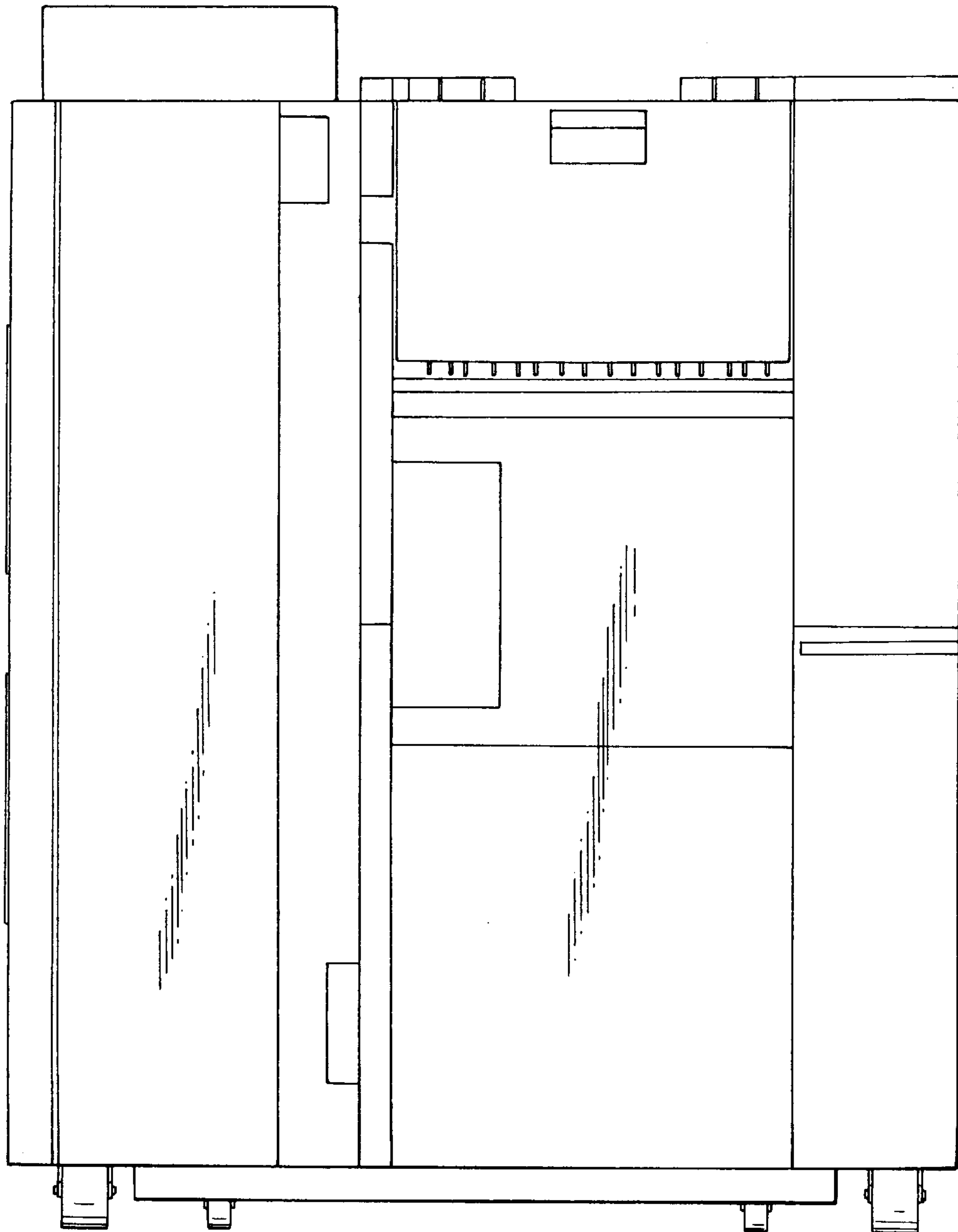

FIG. 4

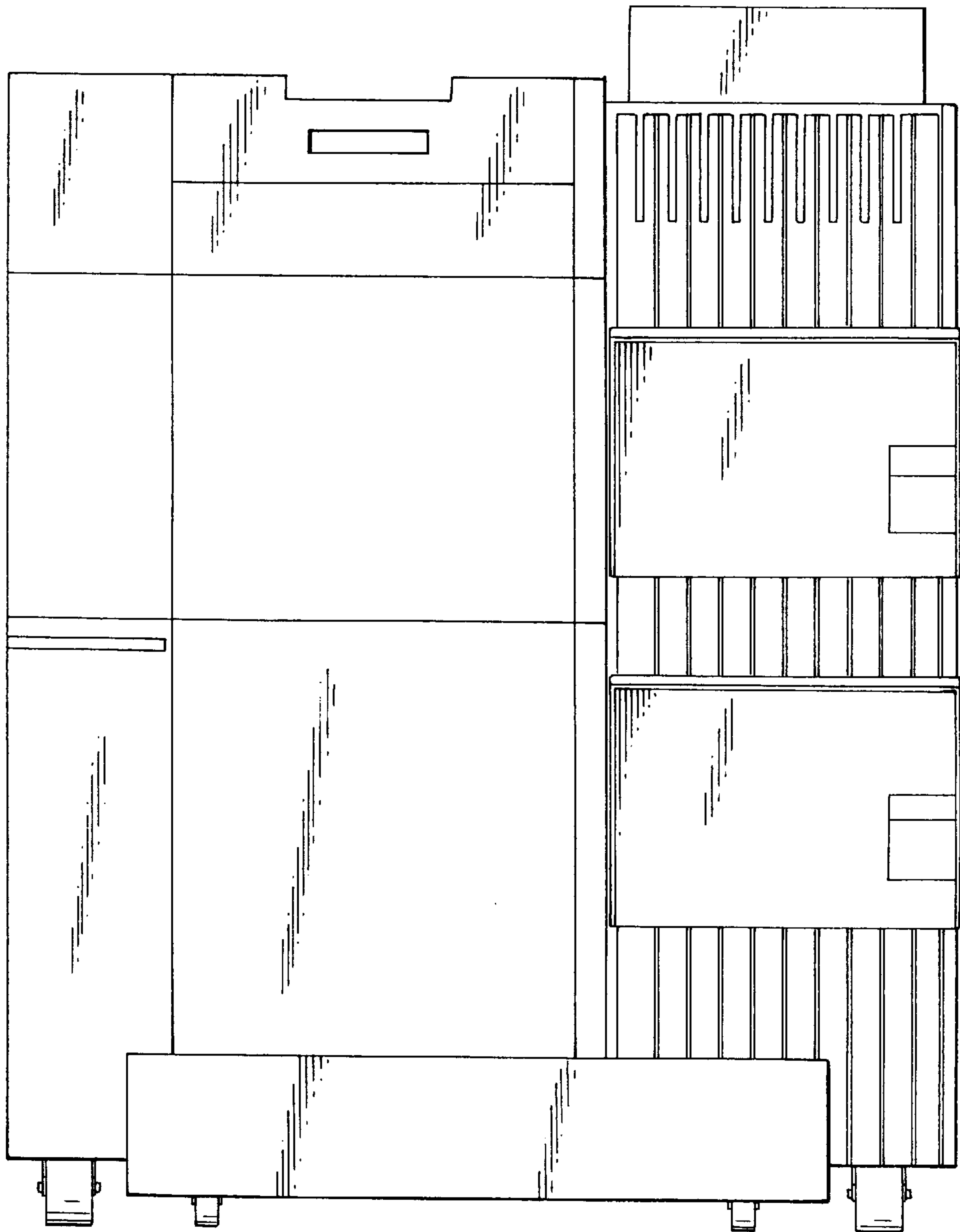

FIG. 5

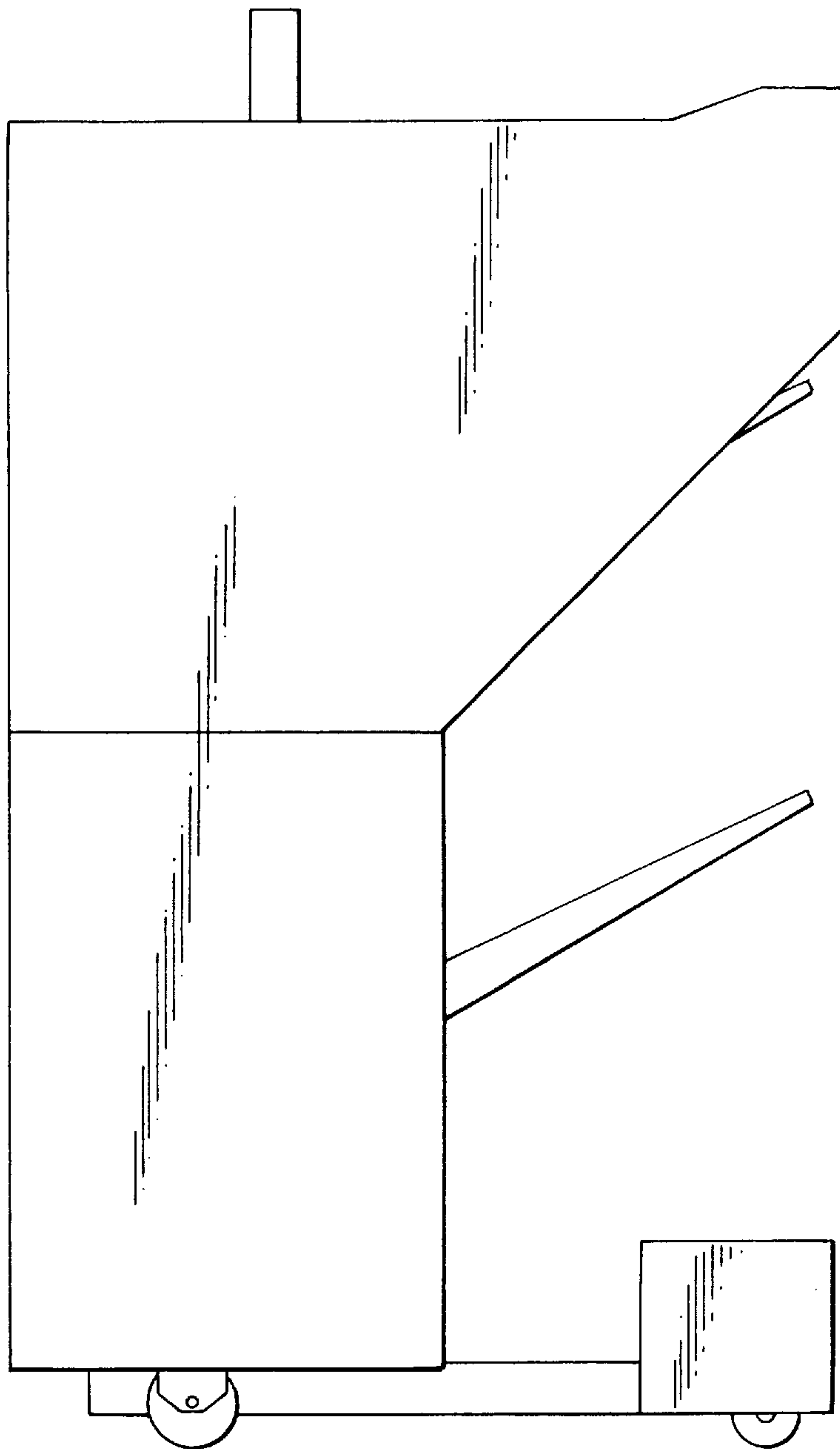

FIG. 6

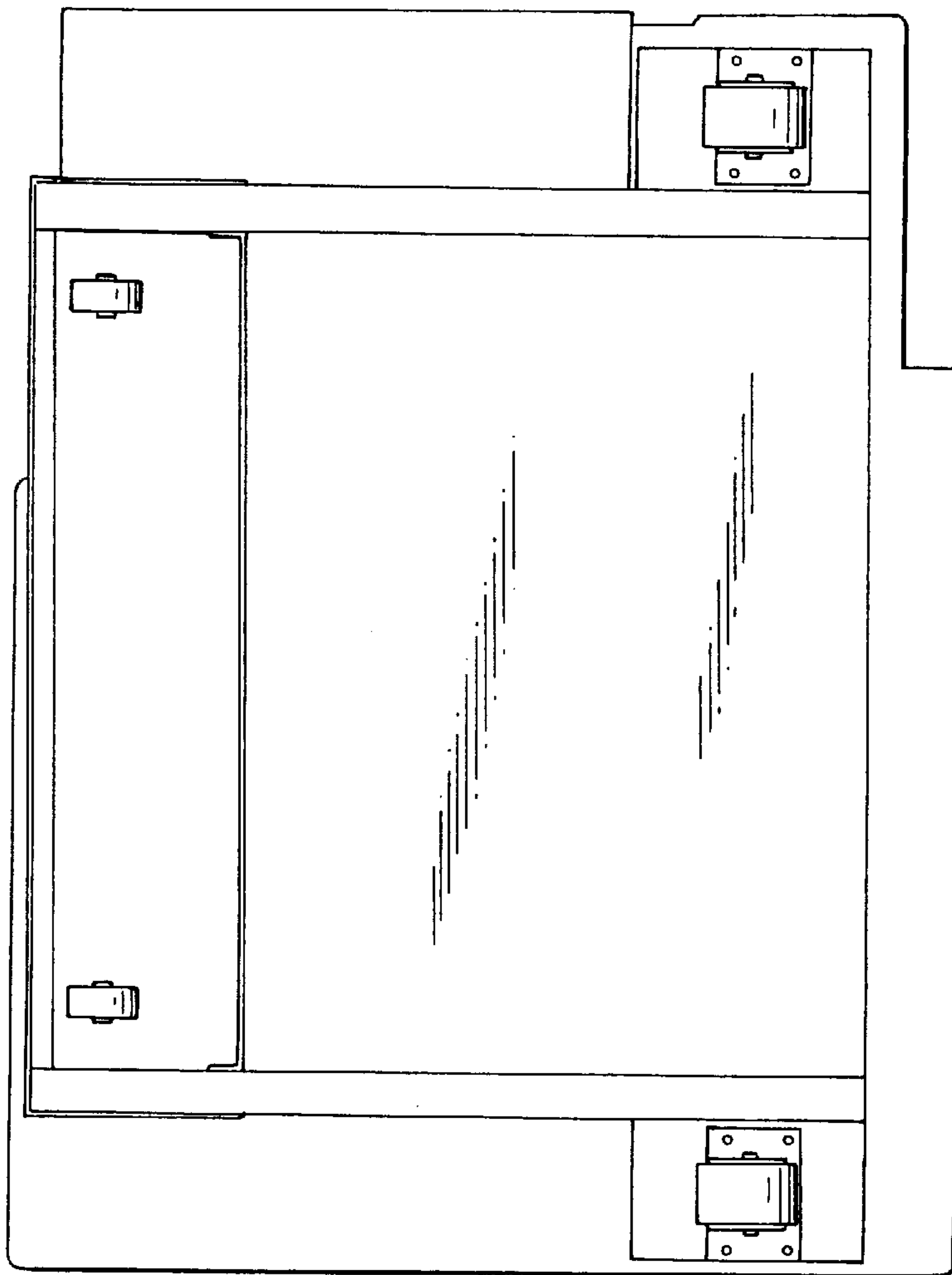

FIG. 7

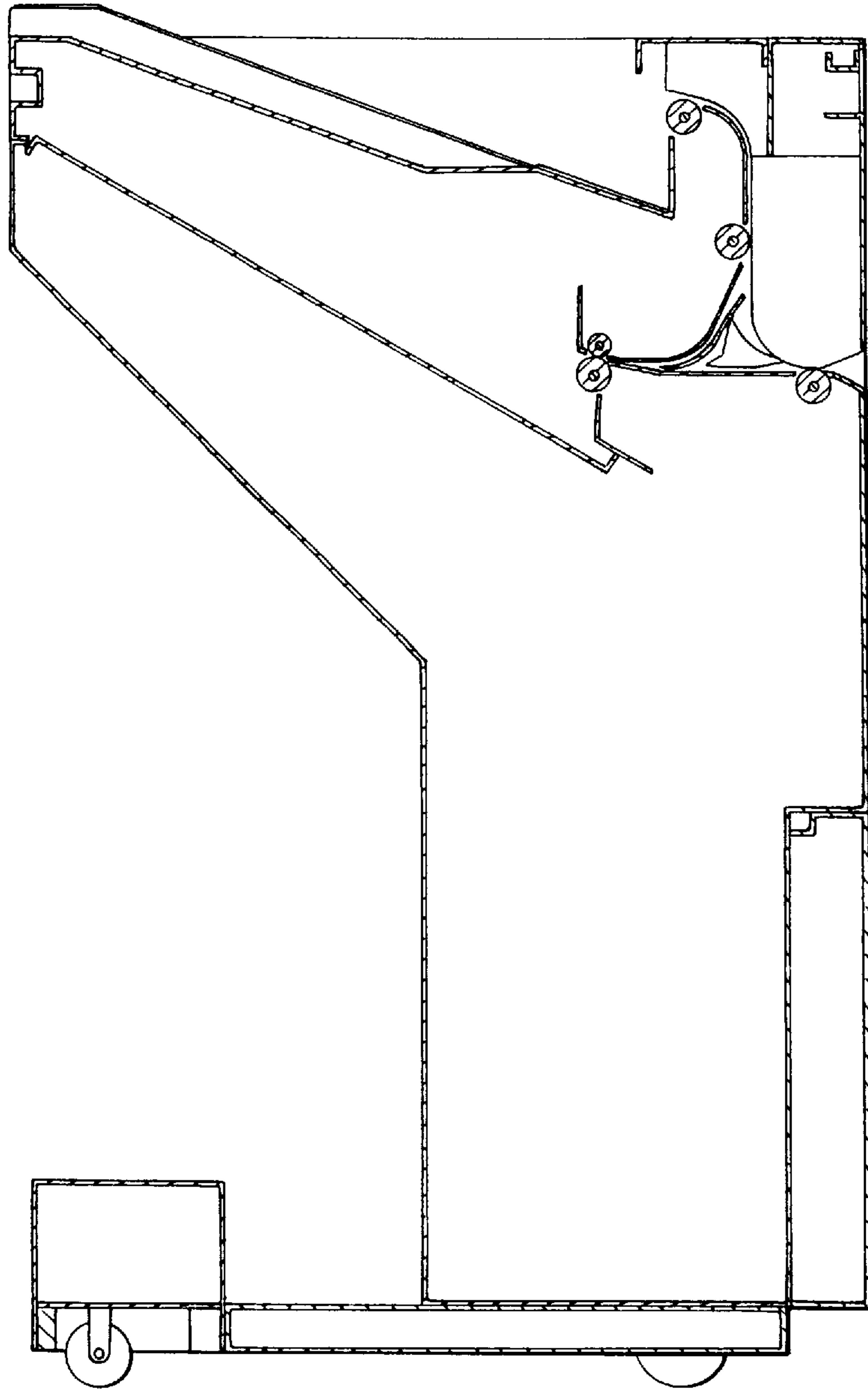

FIG. 8

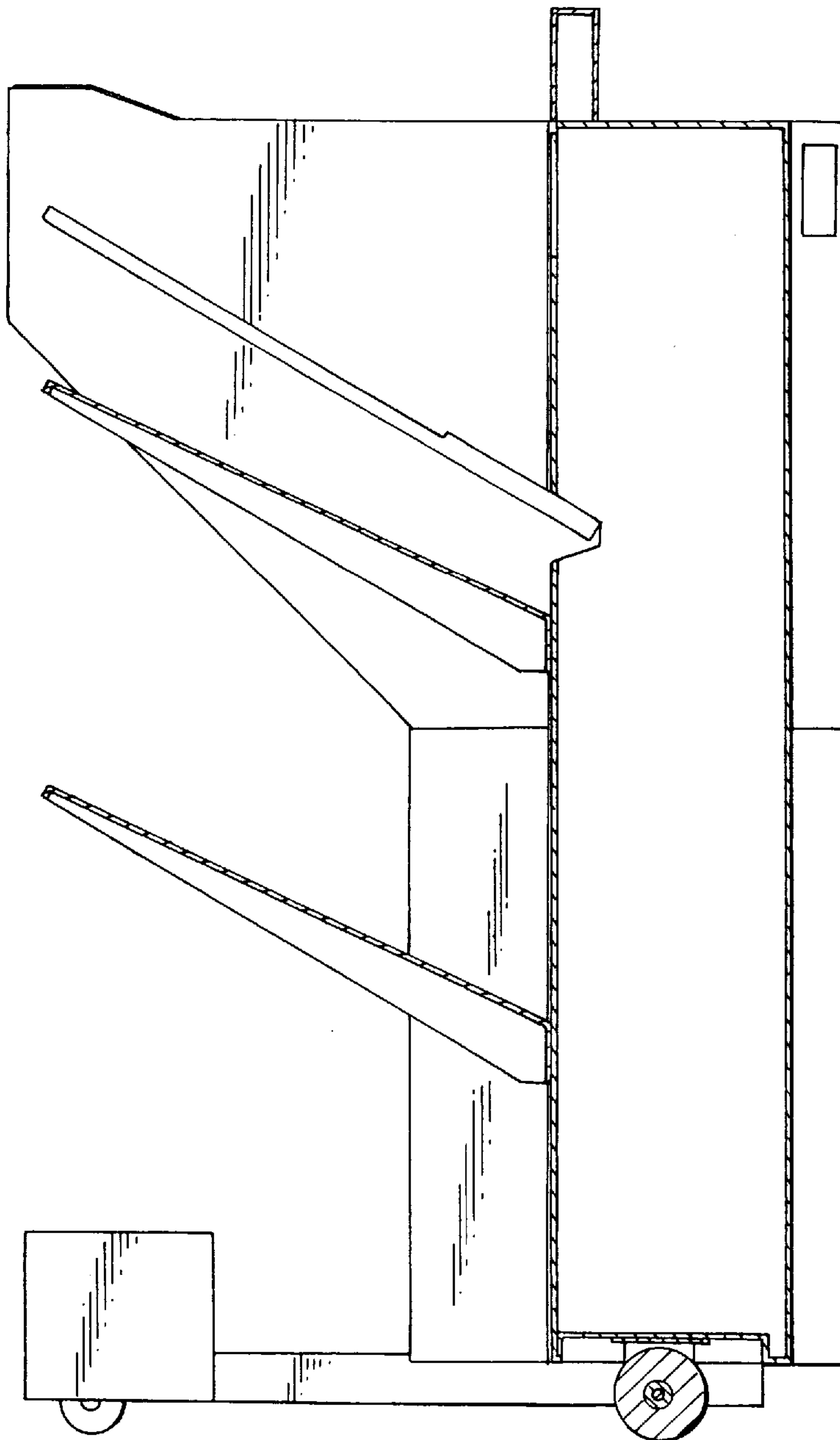

FIG. 9

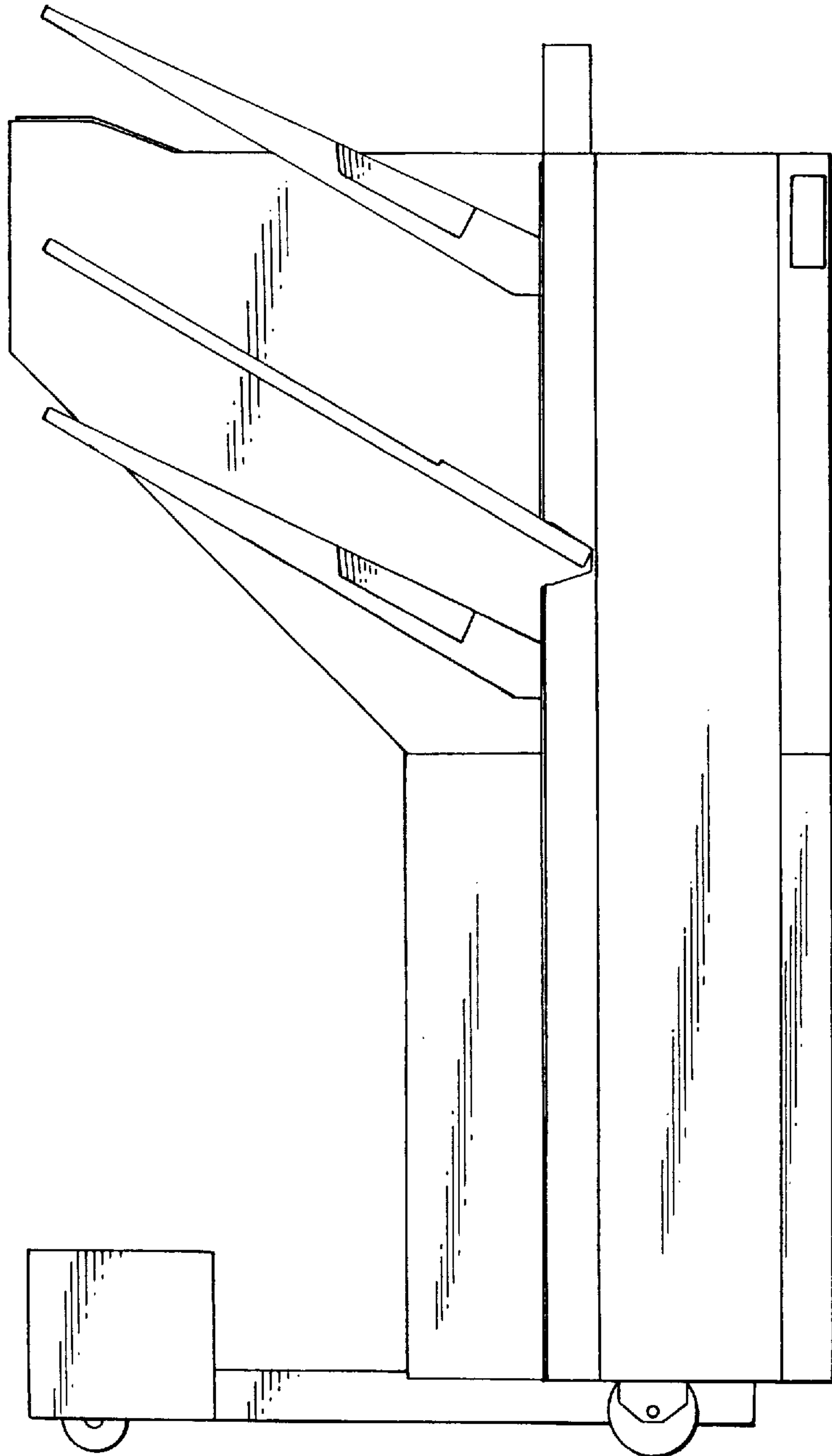
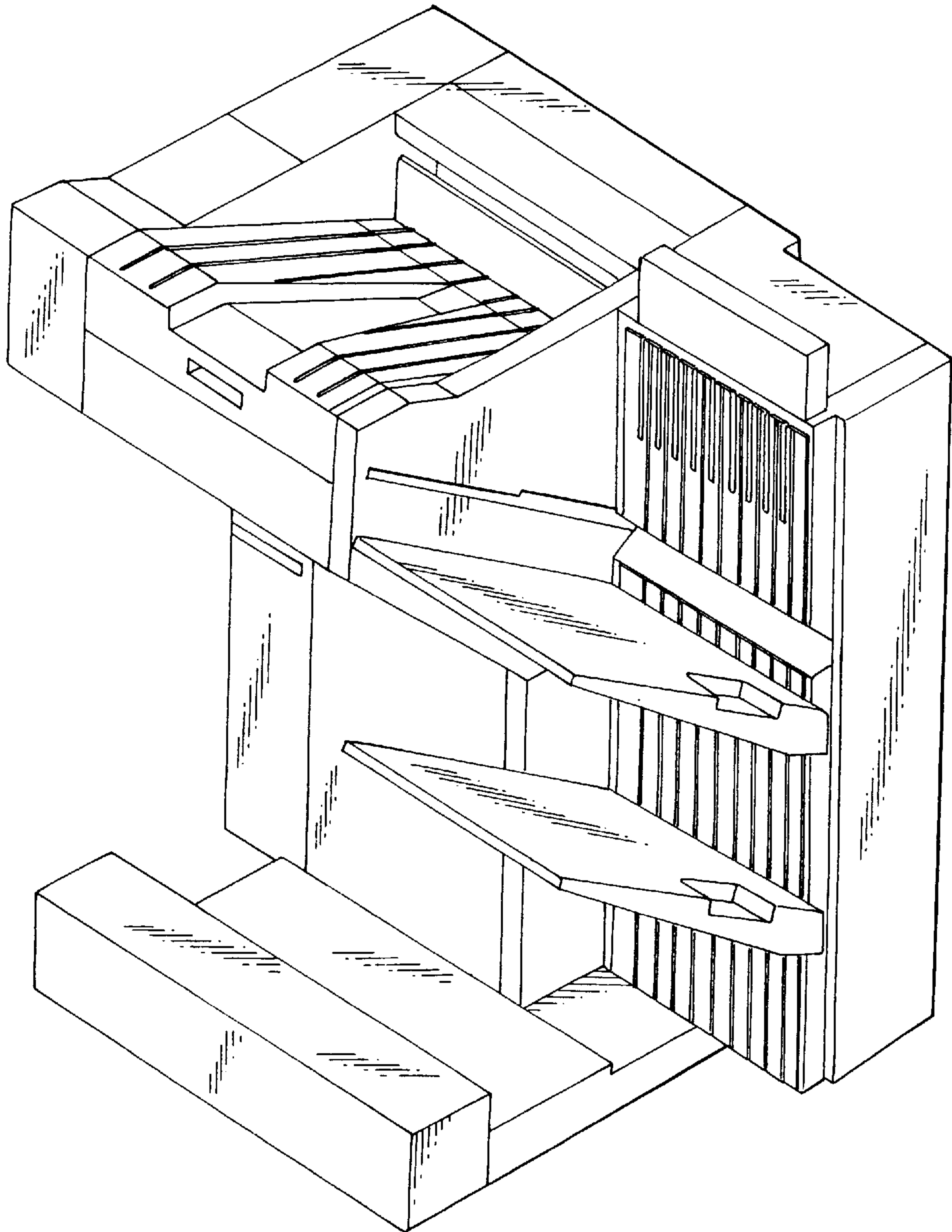

FIG.10



UNITED STATES PATENT AND TRADEMARK OFFICE
CERTIFICATE OF CORRECTION

PATENT NO. : Des. 403,349

DATED : December 29, 1998

INVENTOR(S) : Tomoyuki Hirose, et al.

It is certified that error appears in the above-identified patent and that said Letters Patent is hereby corrected as shown below:

On the title page, between Items [22] and [51], please insert the following information:

[30] Foreign Application Priority Data

Jun 23, 1997 [JP] Japan.....9-59131

Signed and Sealed this
Thirty-first Day of August, 1999

Attest:

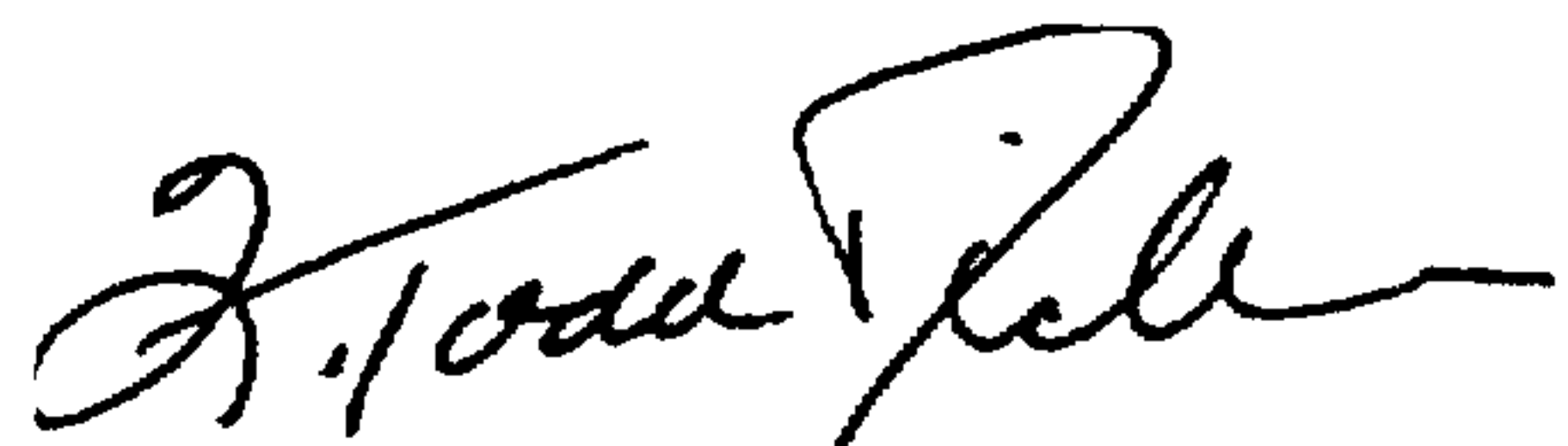

Q. TODD DICKINSON

Attesting Officer

Acting Commissioner of Patents and Trademarks