



US00D403331S

United States Patent [19] Williams

[11] Patent Number: Des. 403,331

[45] Date of Patent: **Dec. 29, 1998

[54] AIR COMPRESSOR

[75] Inventor: Kevin Williams, Brooklyn, N.Y.

[73] Assignee: Interdynamics, Inc., Brooklyn, N.Y.

[**] Term: 14 Years

[21] Appl. No.: 78,721

[22] Filed: Nov. 3, 1997

[51] LOC (6) Cl. 15-02

[52] U.S. Cl. D15/9

[58] Field of Search D15/7, 8, 9; 417/231,
417/234, 229, 321, 410-411; D24/8; D26/38

[56] **References Cited**

U.S. PATENT DOCUMENTS

D. 277,675	2/1985	Hung	D15/7
D. 328,465	8/1992	Schwartz et al.	D15/9
D. 340,726	10/1993	Wang	D15/7
D. 352,295	11/1994	Morgan	D15/9

Primary Examiner—Ralf Seifert

Attorney, Agent, or Firm—Levisohn, Lerner, Berger & Langsam

[57] **CLAIM**

The air compressor, as shown and described in the drawings.

DESCRIPTION

FIG. 1 is a perspective view of the air compressor of this invention in a closed configuration;

FIG. 2 is a front view of the air compressor of this invention;

FIG. 3 is a top view of the air compressor of this invention;

FIG. 4 is a side view of the air compressor of this invention;

FIG. 5 is a bottom view of the air compressor of this invention;

FIG. 6 is a right view of the air compressor of this invention;

FIG. 7 is a rear view of the air compressor of this invention;

and,

FIG. 8 is a perspective view of the air compressor of this invention in an open configuration.

The broken line showing of a luminaire in FIGS. 1-5, 7 and 8, and of a pump, hose and gauge in FIG. 8, is for illustrative purposes only and forms no part of the claimed design.

Further, the portion of the air compressor immediately behind and obscured by the luminaire shown in broken lines in FIGS. 1-5, 7 and 8 is also not part of the claimed design.

1 Claim, 5 Drawing Sheets

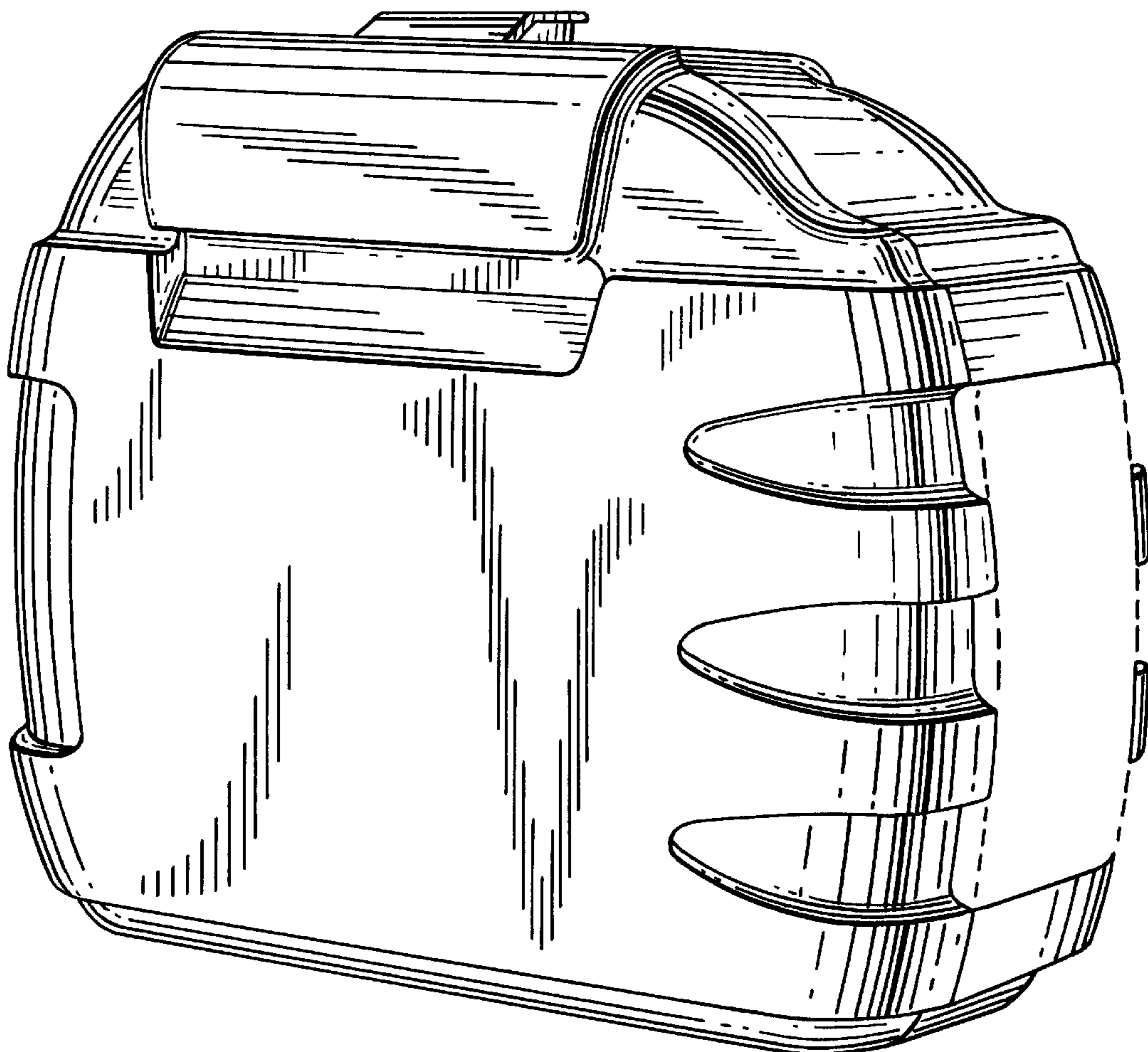

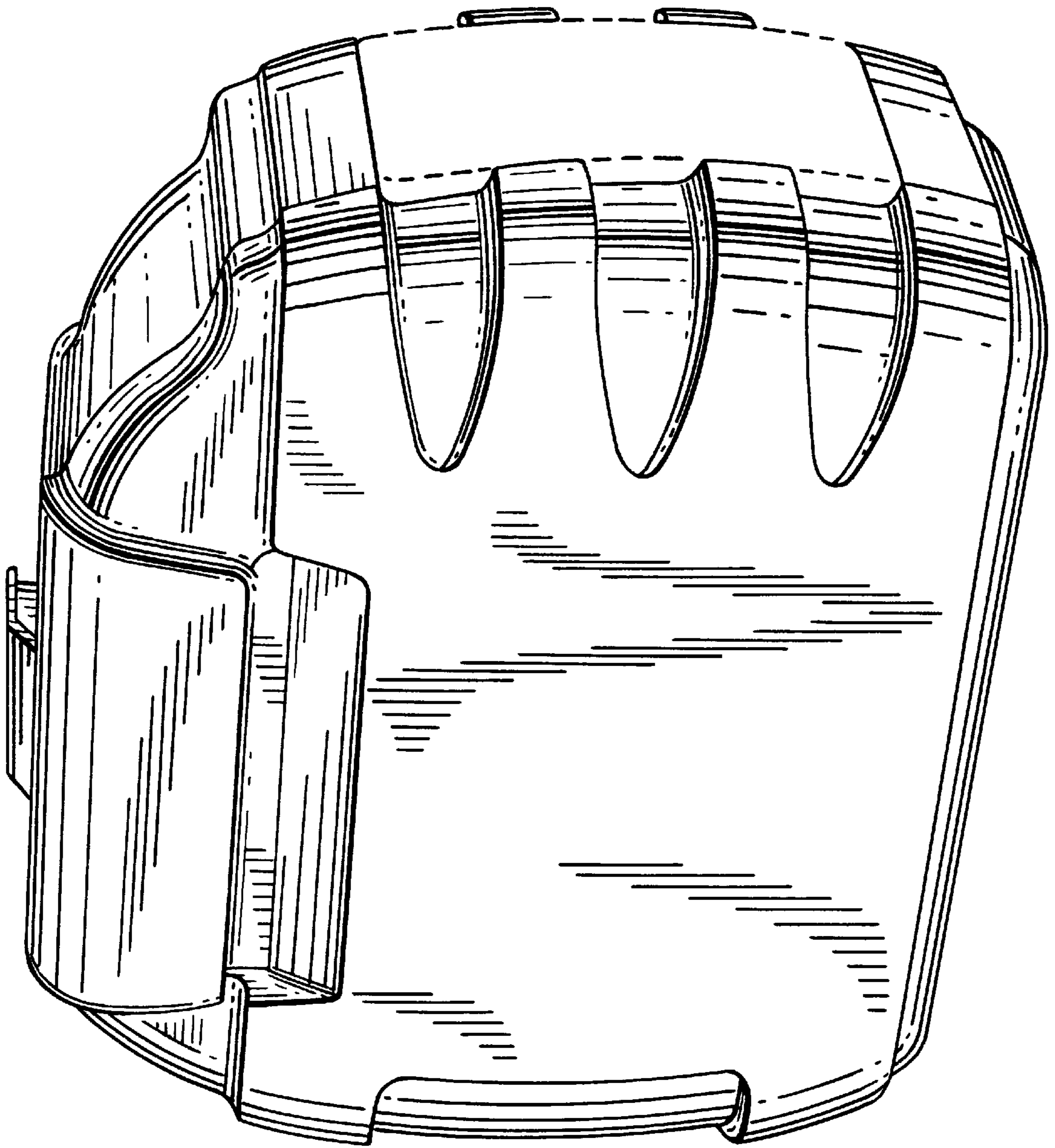

FIG. 1

FIG. 2

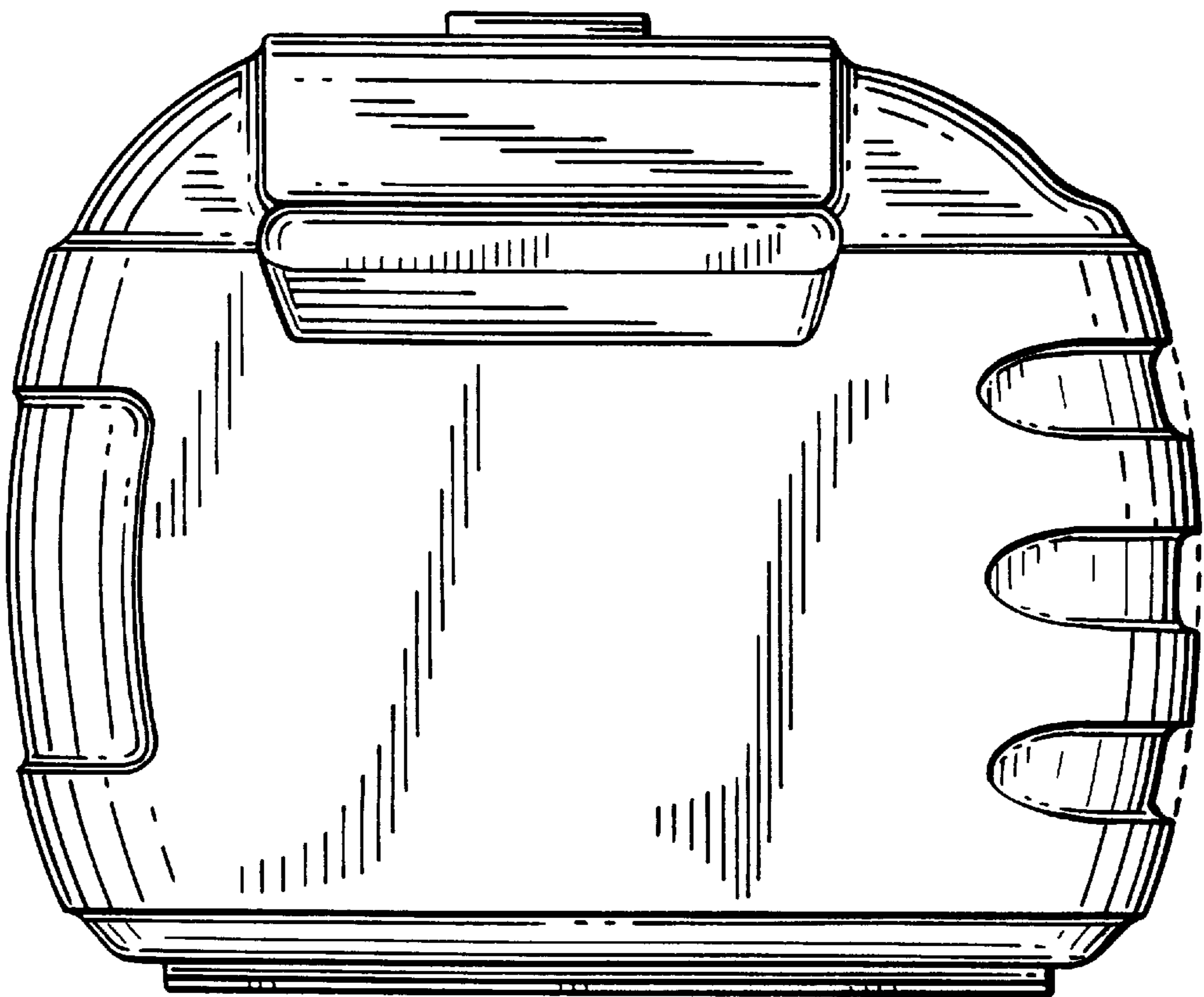
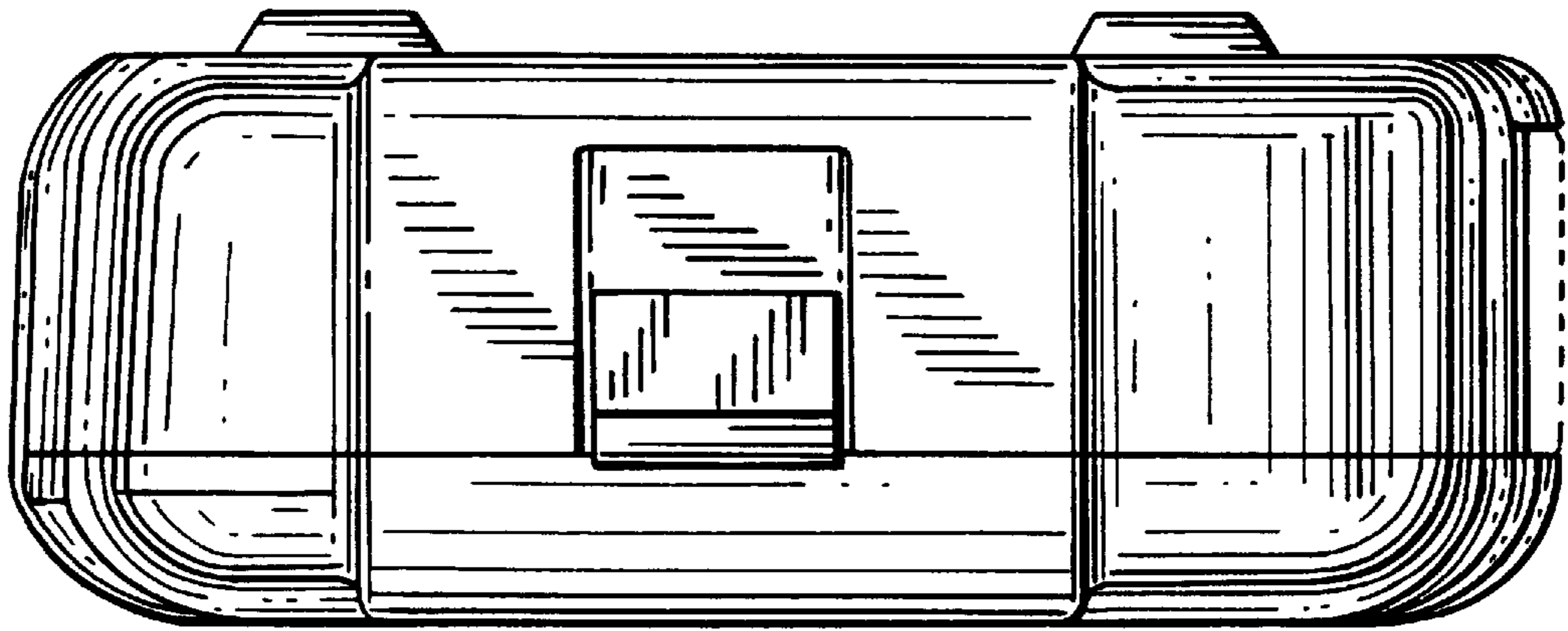

FIG. 3

FIG. 5

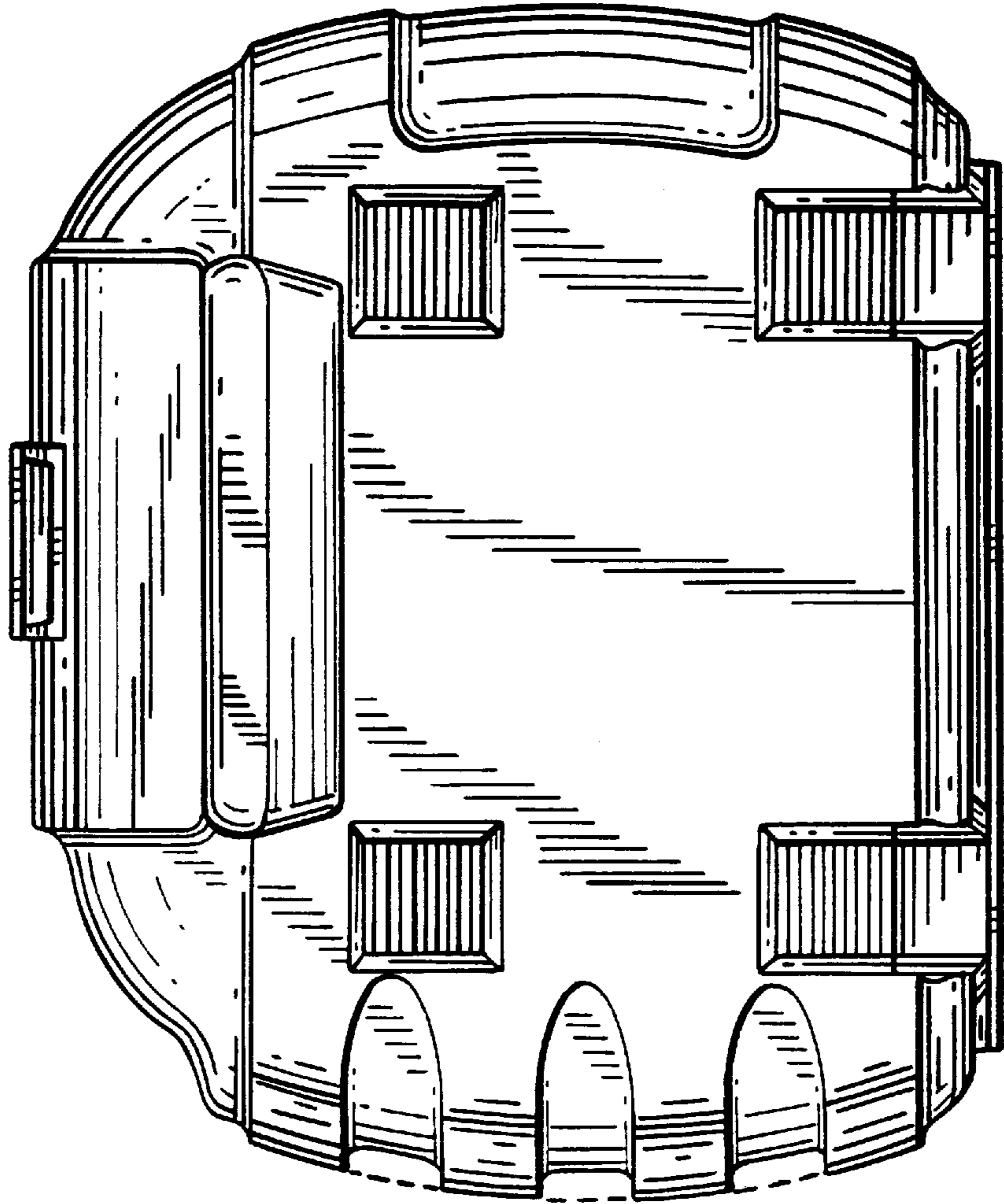

FIG. 4

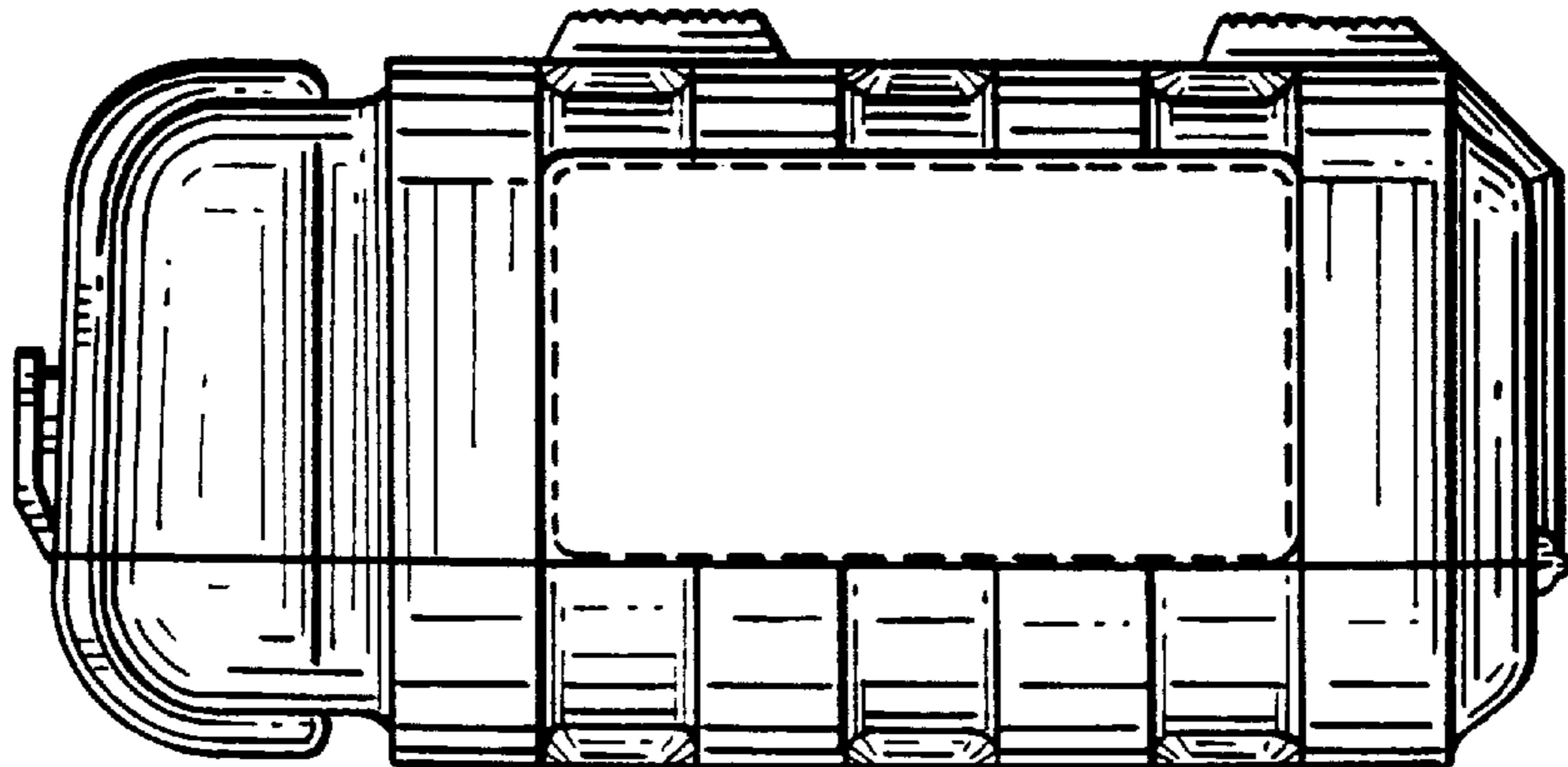

FIG. 6

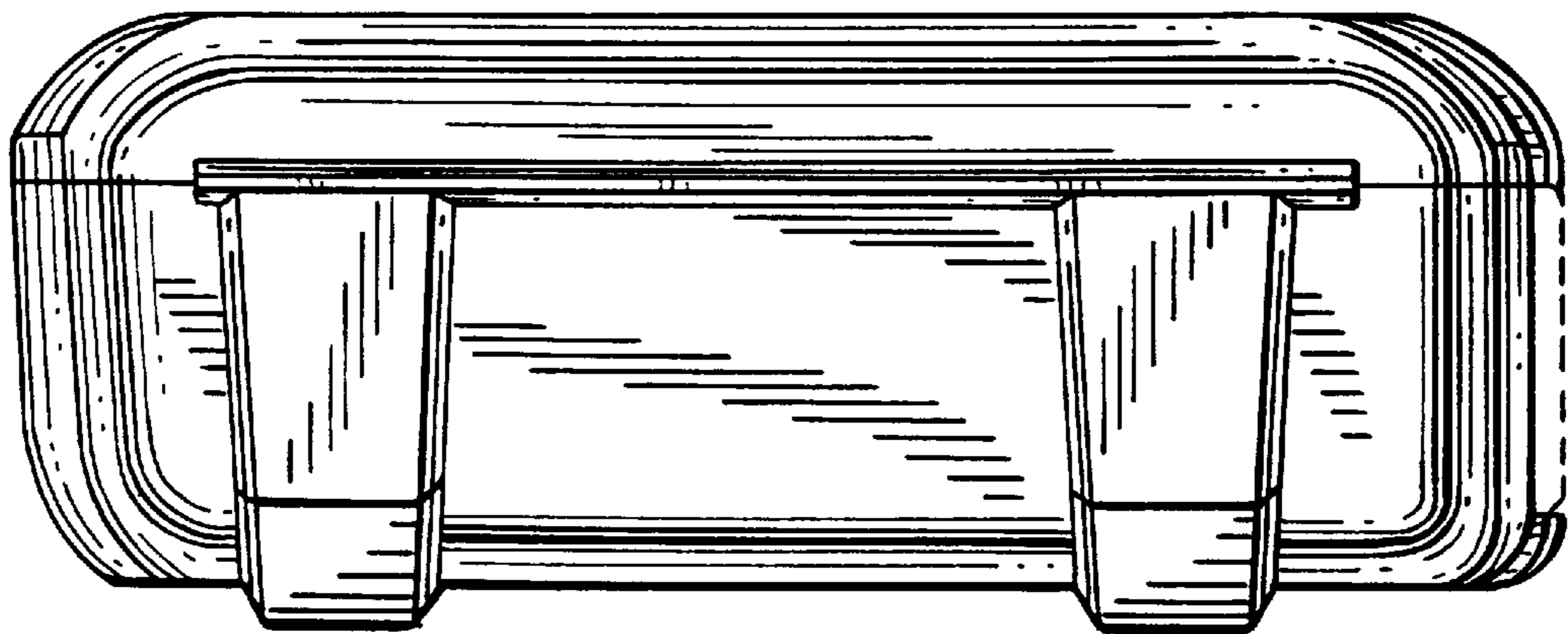
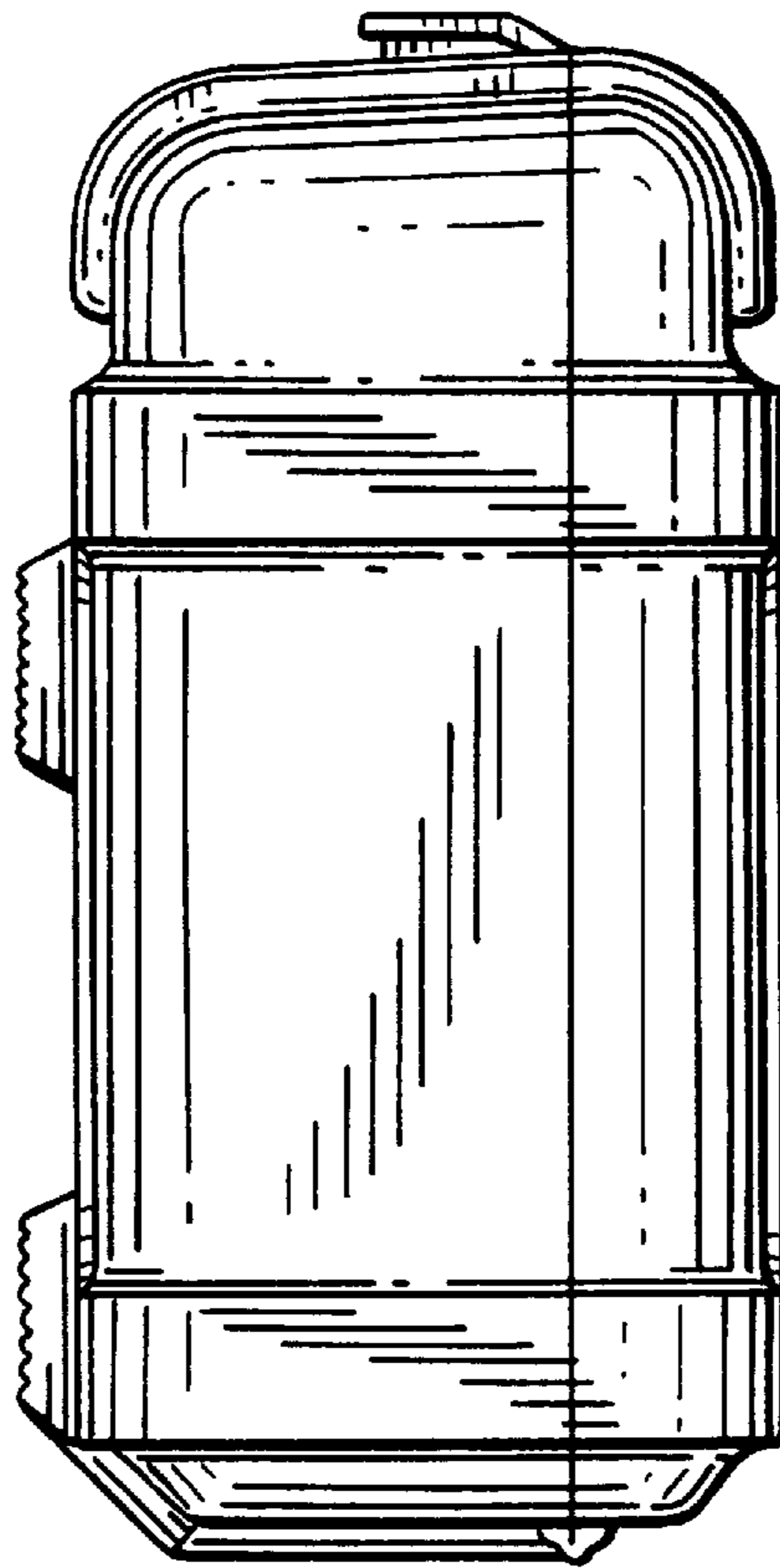

FIG. 7

FIG. 8

