



US00D403306S

United States Patent [19]

LeClair et al.

[11] Patent Number: **Des. 403,306**

[45] Date of Patent: ****Dec. 29, 1998**

[54] **ROCKER SWITCH ACTUATOR**

D. 394,042 5/1998 Hwang D13/171

[75] Inventors: **Joseph L. LeClair**, Waterbury; **Teresa Jo Errato**, Higganum, both of Conn.

Primary Examiner—Brian N. Vinson
Attorney, Agent, or Firm—McCormick, Paulding & Huber

[73] Assignee: **Carlingswitch, Inc.**, Plainville, Conn.

[57] **CLAIM**

[**] Term: **14 Years**

The ornamental design for a rocker switch actuator, as shown and described.

[21] Appl. No.: **75,751**

DESCRIPTION

[22] Filed: **Aug. 22, 1997**

[51] **LOC (6) Cl.** **13-03**

[52] **U.S. Cl.** **D13/169**

[58] **Field of Search** D13/169, 174,
D13/175, 177; 200/296, 302.3, 315, 330,
339

FIG. 1 is a front upper right perspective view of a rocker switch actuator showing our new design;
FIG. 2 is a top plan view of a rocker switch actuator showing our new design on an enlarged scale;
FIG. 3 is a front elevational view thereof, the broken lines showing the switch housing being included for the purpose of illustrating environmental background only and forming no part of the claimed design;
FIG. 4 is a rear elevational view thereof;
FIG. 5 is a left hand side elevational view thereof; and,
FIG. 6 is a right hand side elevational view thereof.

[56] **References Cited**

U.S. PATENT DOCUMENTS

- D. 328,454 8/1992 Sorenson et al. D13/174
- D. 341,568 11/1993 Sorenson et al. D13/174
- D. 388,398 12/1997 Jeong D13/174

1 Claim, 2 Drawing Sheets

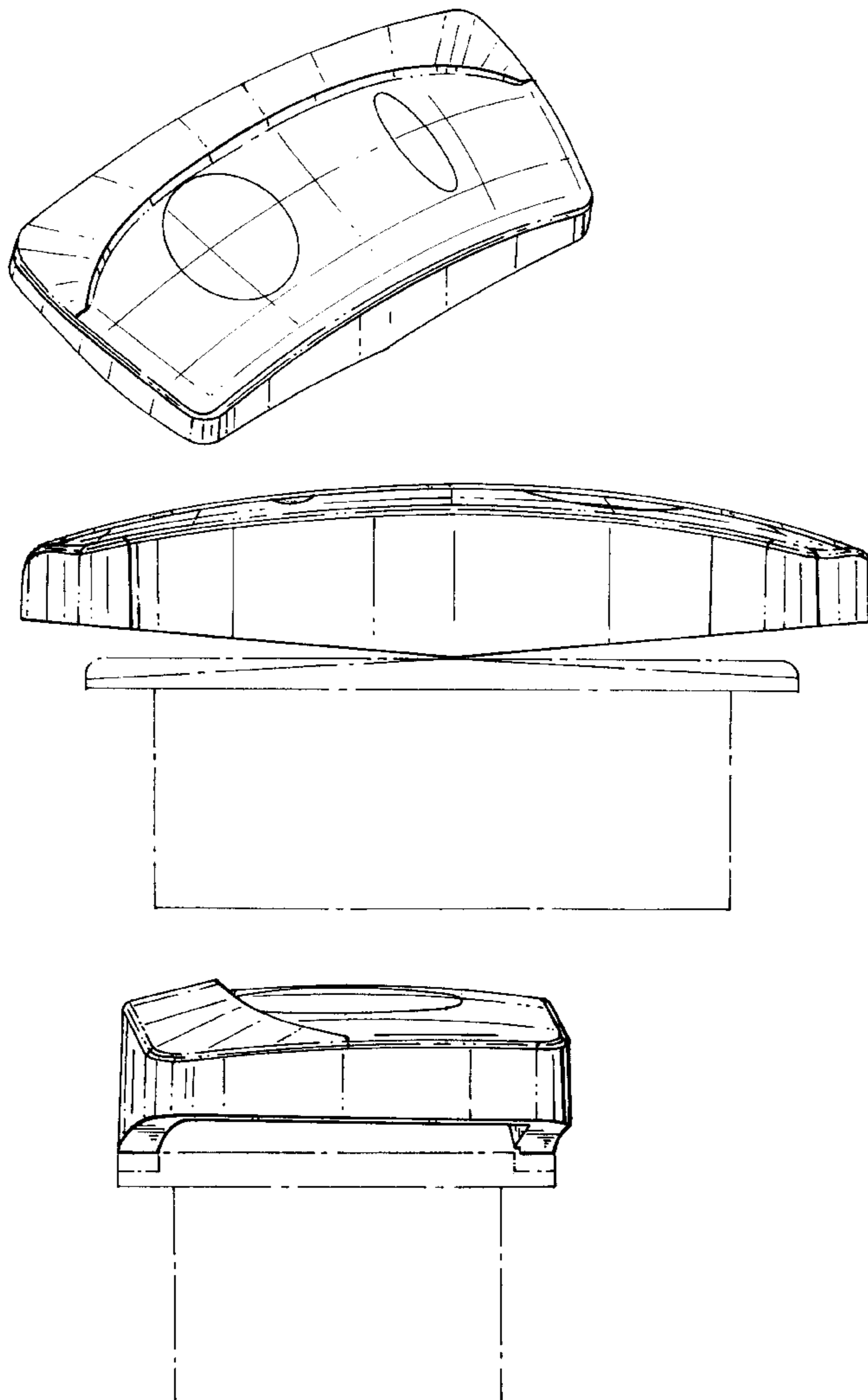

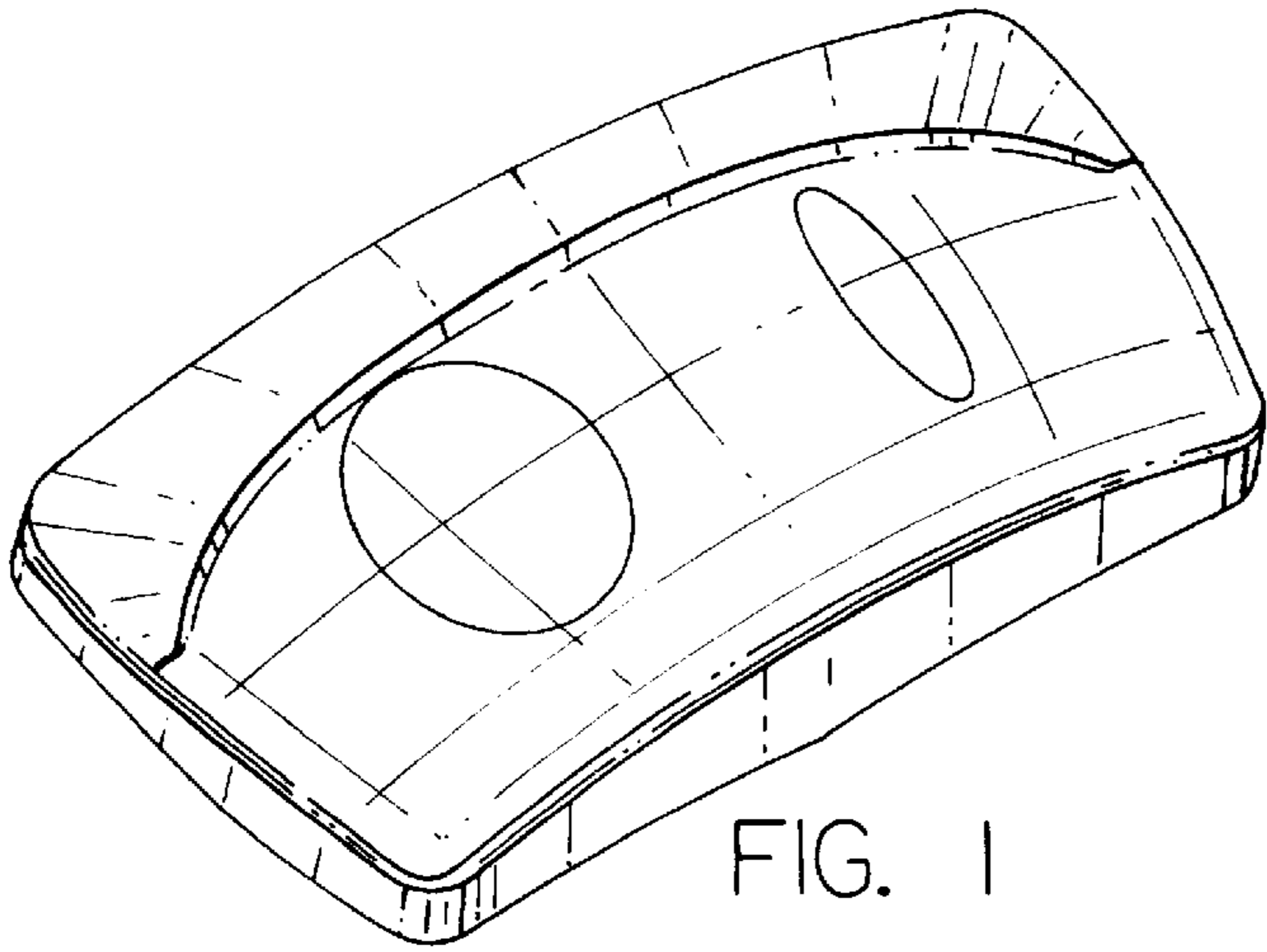

FIG. 1

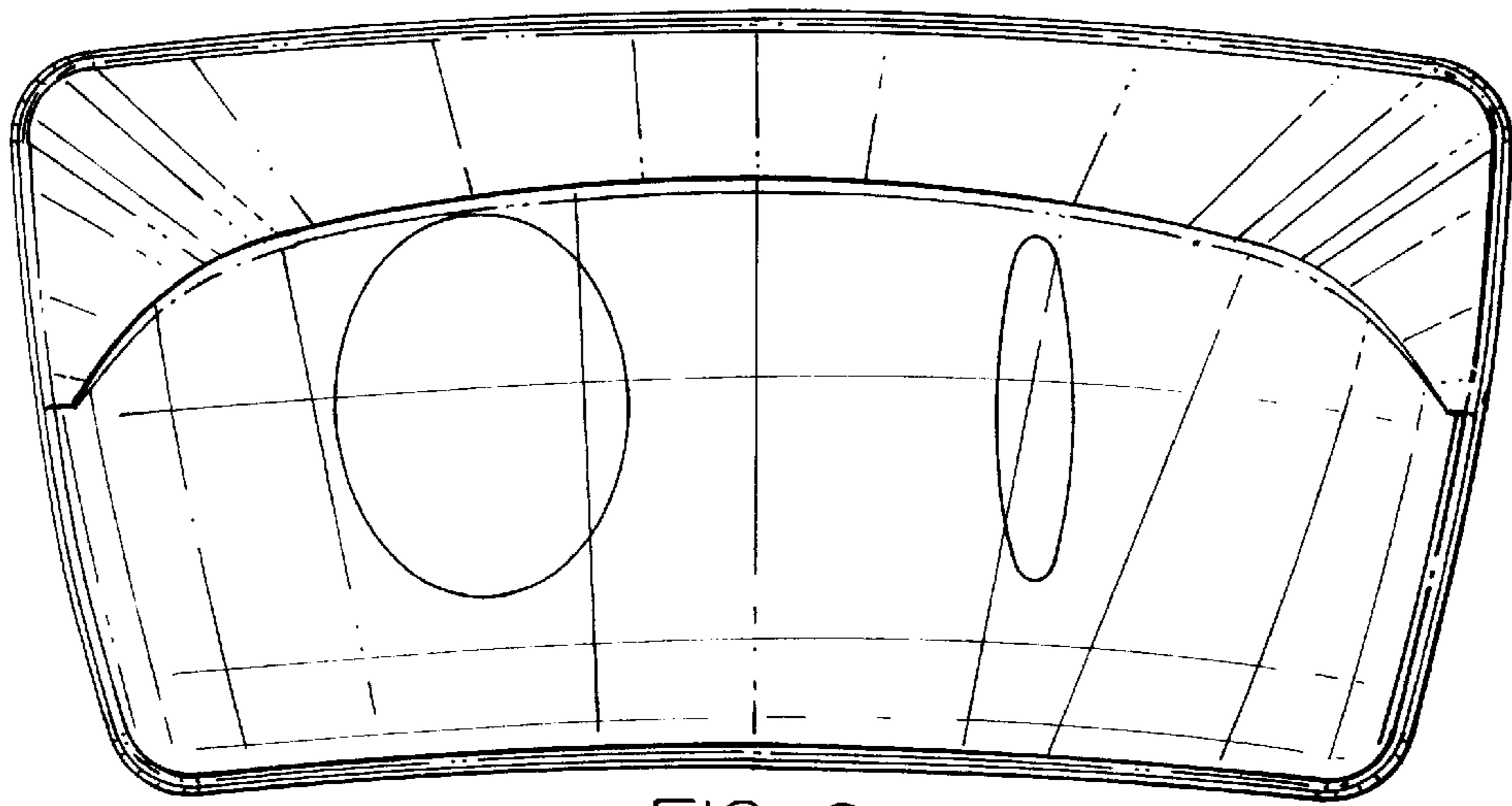

FIG. 2

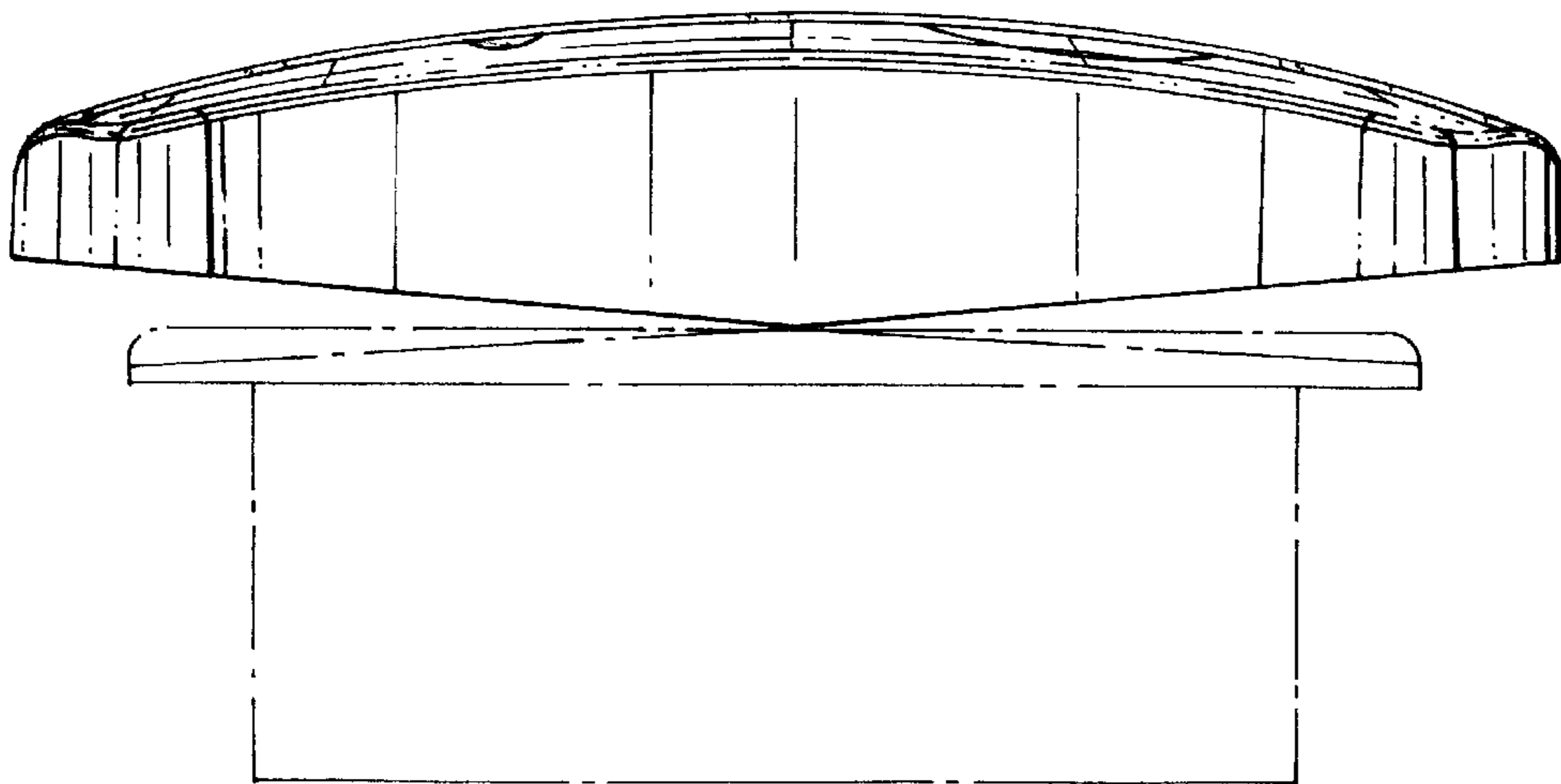

FIG. 3

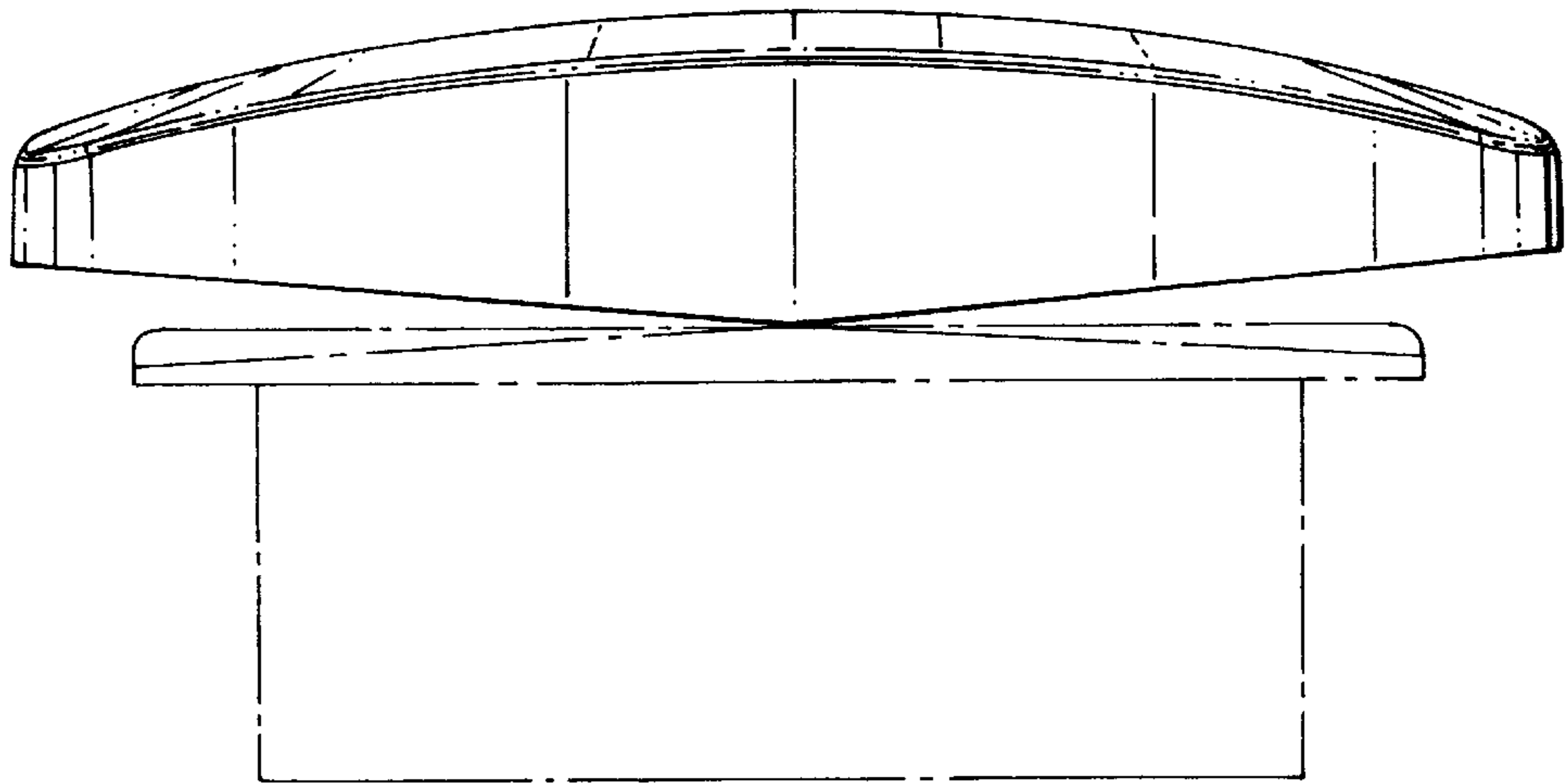

FIG. 4

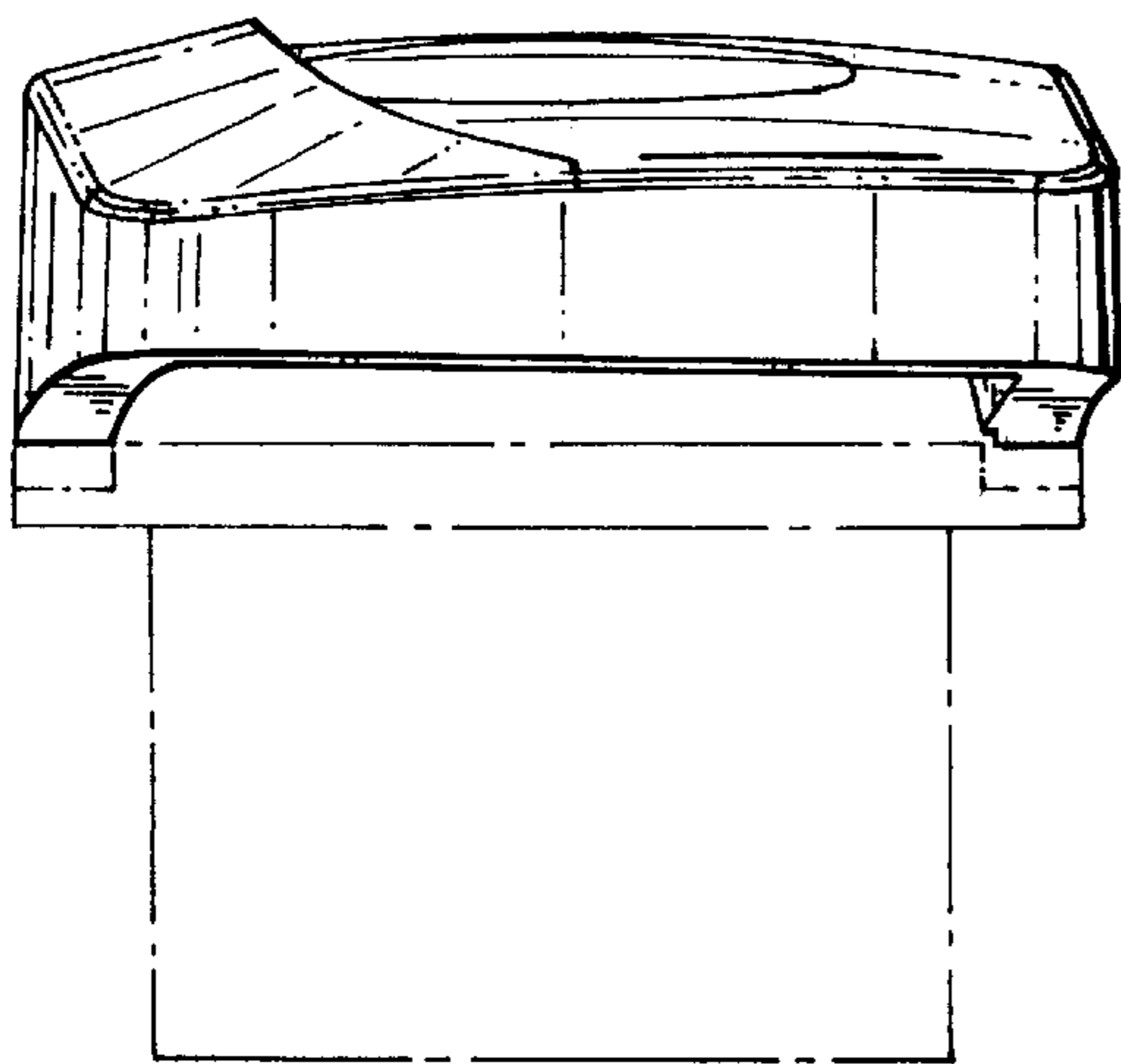

FIG. 5

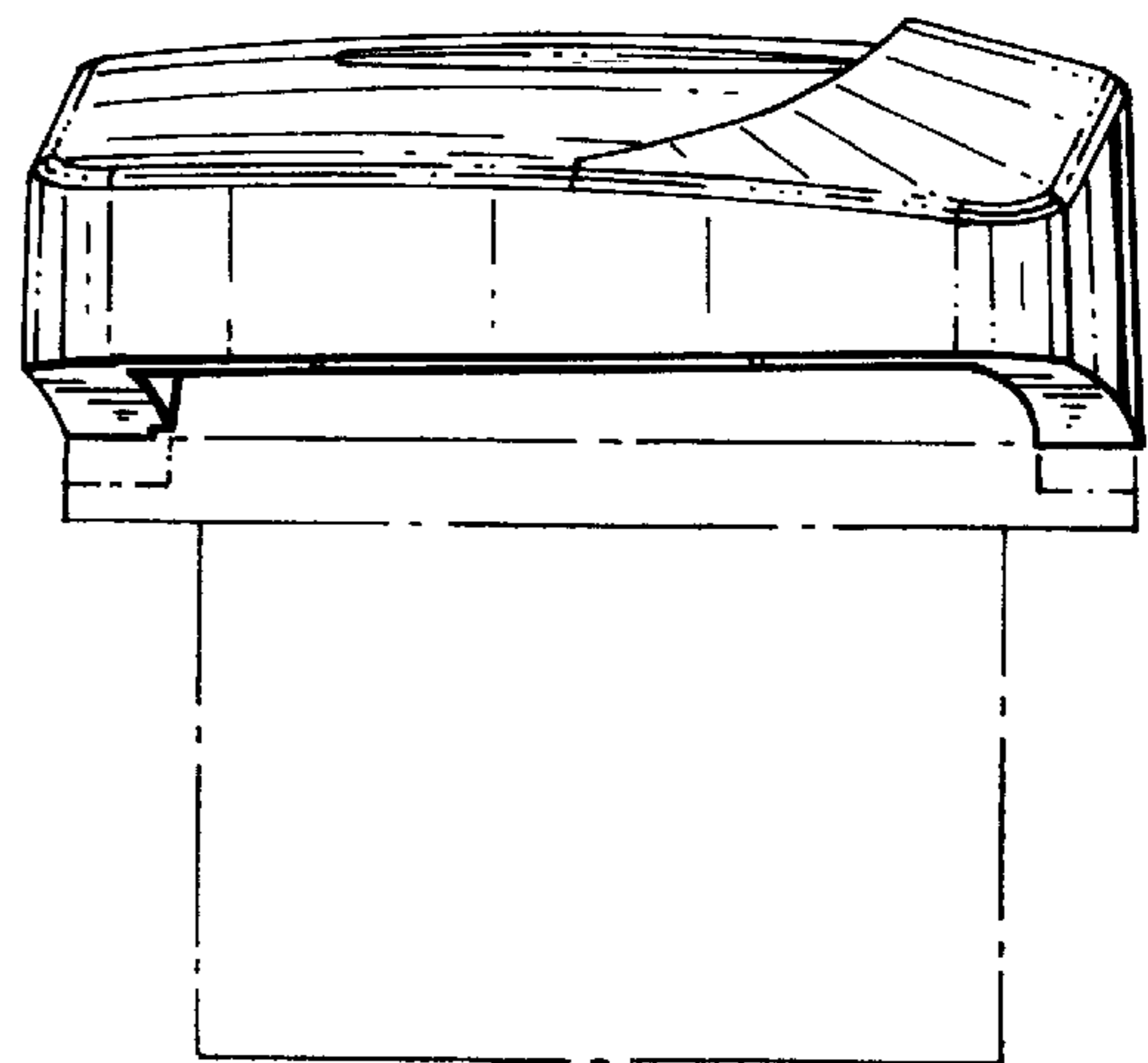

FIG. 6