



US00D403269S

United States Patent [19]

[11] **Patent Number: Des. 403,269**

Weder et al.

[45] **Date of Patent: **Dec. 29, 1998**

[54] **FLOWER POT COVER**

[75] Inventors: **Donald E. Weder; Joseph G. Straeter,**
both of Highland, Ill.

[73] Assignee: **Southpac Trust International, Inc.**

[*] Notice: The term of this patent shall not extend beyond the expiration date of Pat. Nos. Des. 360,382, Des. 360,386, Des. 360,387, Des. 361,294, Des. 361,295, Des. 361,297, Des. 379,780 and Des. 380,981.

[**] Term: **14 Years**

D. 360,386	7/1995	Weder et al.	D11/164
D. 360,387	7/1995	Weder et al.	D11/164
D. 361,294	8/1995	Weder et al.	D11/164
D. 361,295	8/1995	Weder et al.	D11/164
D. 361,297	8/1995	Weder et al.	D11/164
D. 371,521	7/1996	Weder et al.	D11/164
D. 374,204	10/1996	Weder	D11/164
D. 379,780	6/1997	Weder	D11/164
D. 380,981	7/1997	Weder et al.	D11/164
D. 387,012	12/1997	Weder et al.	D11/164
1,300,164	4/1919	Guardino	229/1.5 B
1,520,647	12/1924	Hennegan	47/72
1,794,212	2/1931	Snyder	47/72
3,443,741	5/1969	Stockdale	D9/431 X
4,166,568	9/1979	Swan	229/108

[21] Appl. No.: **72,641**

[22] Filed: **Jun. 20, 1997**

Related U.S. Application Data

[62] Division of Ser. No. 54,026, May 6, 1996, Pat. No. 8,387,012, which is a division of Ser. No. 3,869, Jan. 21, 1993, Pat. No. 8,371,521, which is a continuation-in-part of Ser. No. 808,548, Dec. 16, 1991, Pat. No. 8,355,395, which is a continuation-in-part of Ser. No. 710,272, Jun. 4, 1991, Pat. No. 8,365,302, which is a continuation-in-part of Ser. No. 617,454, Nov. 21, 1990, abandoned, said Ser. No. 710,272, Jun. 4, 1991, Pat. No. 8,365,302, is a continuation-in-part of Ser. No. 411,249, Sep. 22, 1989, Pat. No. 8,358,113, said Ser. No. 710,272, Jun. 4, 1991, Pat. No. 8,365,302, is a continuation-in-part of Ser. No. 411,247, Sep. 22, 1989, abandoned, said Ser. No. 710,272, Jun. 4, 1991, Pat. No. 8,365,302, is a continuation-in-part of Ser. No. 411,245, Sep. 22, 1989, abandoned.

[51] **LOC (6) Cl.** **11-02**

[52] **U.S. Cl.** **D11/164**

[58] **Field of Search** D11/143, 149, D11/152-156, 164, 89, 90; 47/66, 72; 206/423; 215/100.5; 229/1.5 R, 1.5 B, 4.5, 108, 108.1, 109, 110, 87.01, 922, 930, 186, 189; 428/27, 35.1, 24, 542.6; D9/346, 428-431; D27/102, 133; D26/128-136; D19/96; D7/540, 584, 586, 587, 354

[56] References Cited

U.S. PATENT DOCUMENTS

D. 360,382 7/1995 Weder et al. D11/164

FOREIGN PATENT DOCUMENTS

785369	8/1935	France	229/186
153402	of 1903	Germany	47/72
1115	of 1887	Sweden	47/72
17903	5/1899	Switzerland	47/72
54263	7/1912	Switzerland	47/72

OTHER PUBLICATIONS

The Glassware of Frederick Carder, p. 217, (c) 1971.

Primary Examiner—Jeffrey Asch
Attorney, Agent, or Firm—Dunlap & Codding, P.C.

[57] CLAIM

The ornamental design for a flower pot cover, as shown and described.

DESCRIPTION

FIG. 1 is a perspective view of our new flower pot cover design;
FIG. 2 is a side elevational view thereof;
FIG. 3 is a top plan view thereof;
FIG. 4 is a bottom plan view thereof;
FIG. 5 is a perspective view of a second embodiment of our new flower pot cover design;
FIG. 6 is a side elevational view thereof;
FIG. 7 is a top plan view thereof;
FIG. 8 is a bottom plan view thereof;
FIG. 9 is a perspective view of a third embodiment of our new flower pot cover design;
FIG. 10 is a side elevational view thereof;

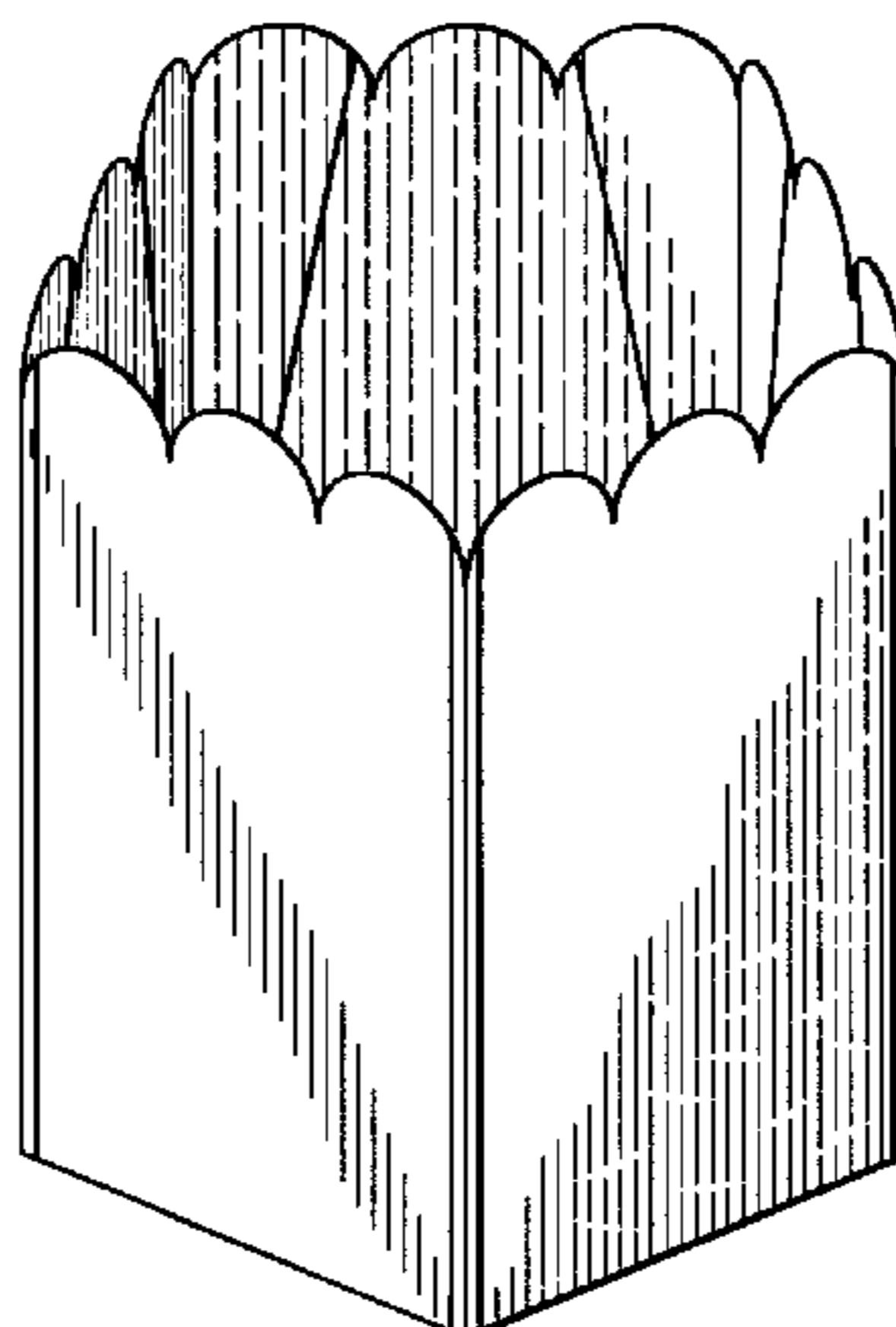

FIG. 11 is a top plan view thereof;
FIG. 12 is a bottom plan view thereof;
FIG. 13 is a perspective view of a fourth embodiment of our new flower pot cover design;
FIG. 14 is a side elevational view thereof;
FIG. 15 is a top plan view thereof;
FIG. 16 is a bottom plan view thereof;
FIG. 17 is a perspective view of a fifth embodiment of our new flower pot cover design;
FIG. 18 is a side elevational view thereof;
FIG. 19 is a top plan view thereof;
FIG. 20 is a bottom plan view thereof;
FIG. 21 is a perspective view of a sixth embodiment of our new flower pot cover design;
FIG. 22 is a side elevational view thereof;
FIG. 23 is a top plan view thereof;
FIG. 24 is a bottom plan view thereof;

FIG. 25 is a perspective view of a seventh embodiment of our new flower pot cover design;
FIG. 26 is a side elevational view thereof;
FIG. 27 is a top plan view thereof;
FIG. 28 is a bottom plan view thereof;
FIG. 29 is a perspective view of an eighth embodiment of our new flower pot cover design;
FIG. 30 is a side elevational view thereof;
FIG. 31 is a top plan view thereof;
FIG. 32 is a bottom plan view thereof;
FIG. 33 is a perspective view of a ninth embodiment of our new flower pot cover design;
FIG. 34 is a side elevational view thereof;
FIG. 35 is a top plan view thereof; and,
FIG. 36 is a bottom plan view thereof.

1 Claim, 6 Drawing Sheets

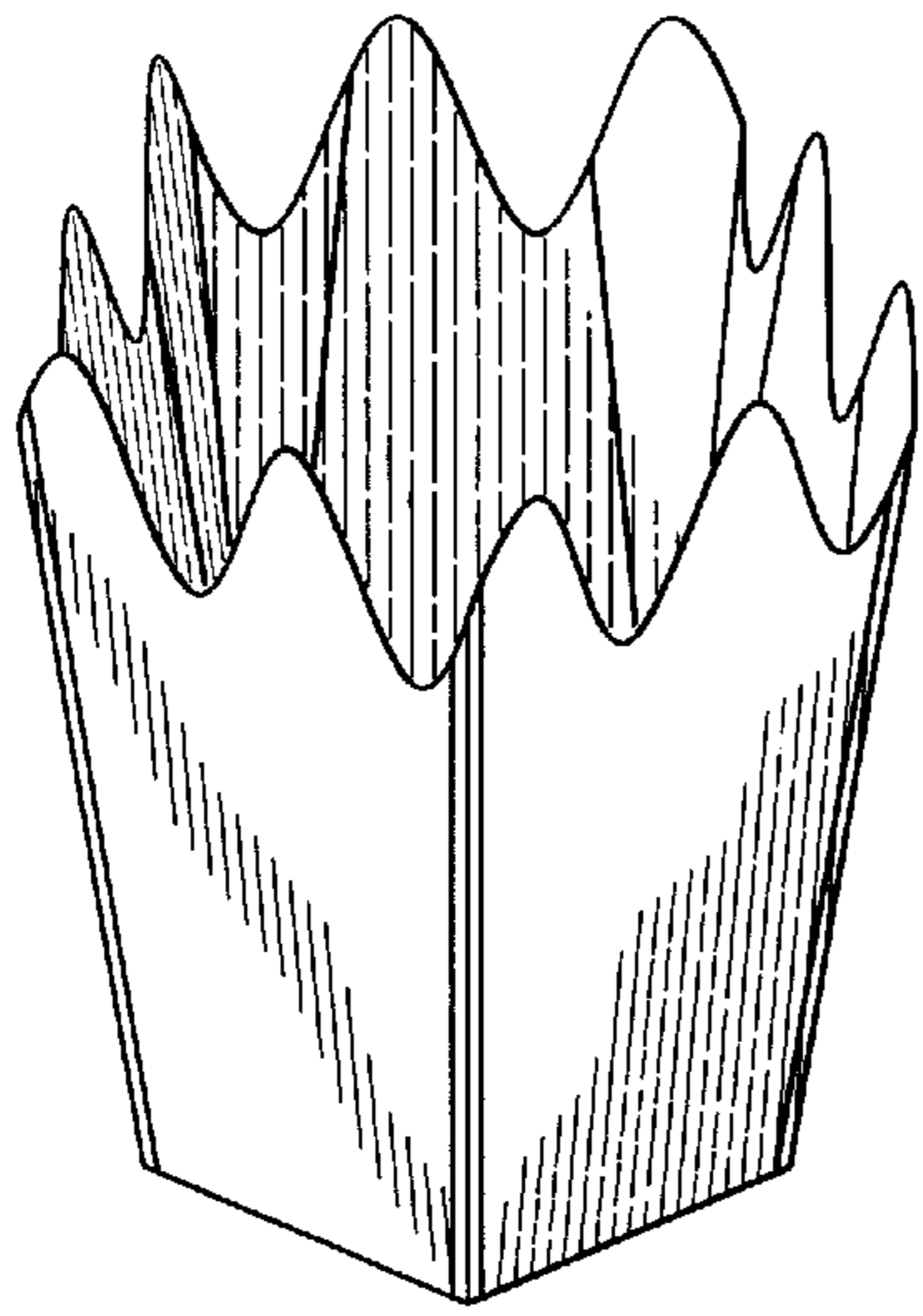

FIG. 1

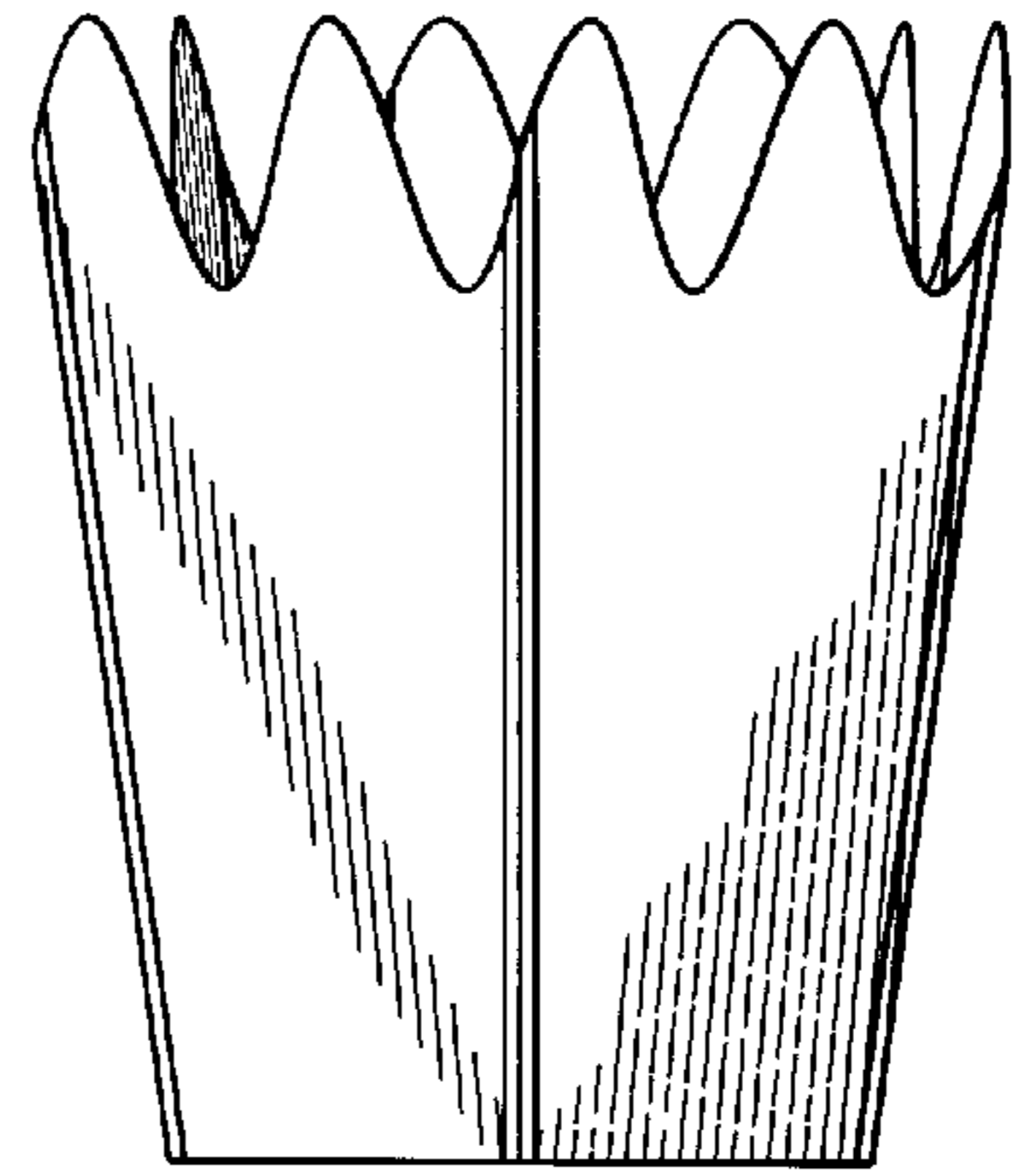

FIG. 2

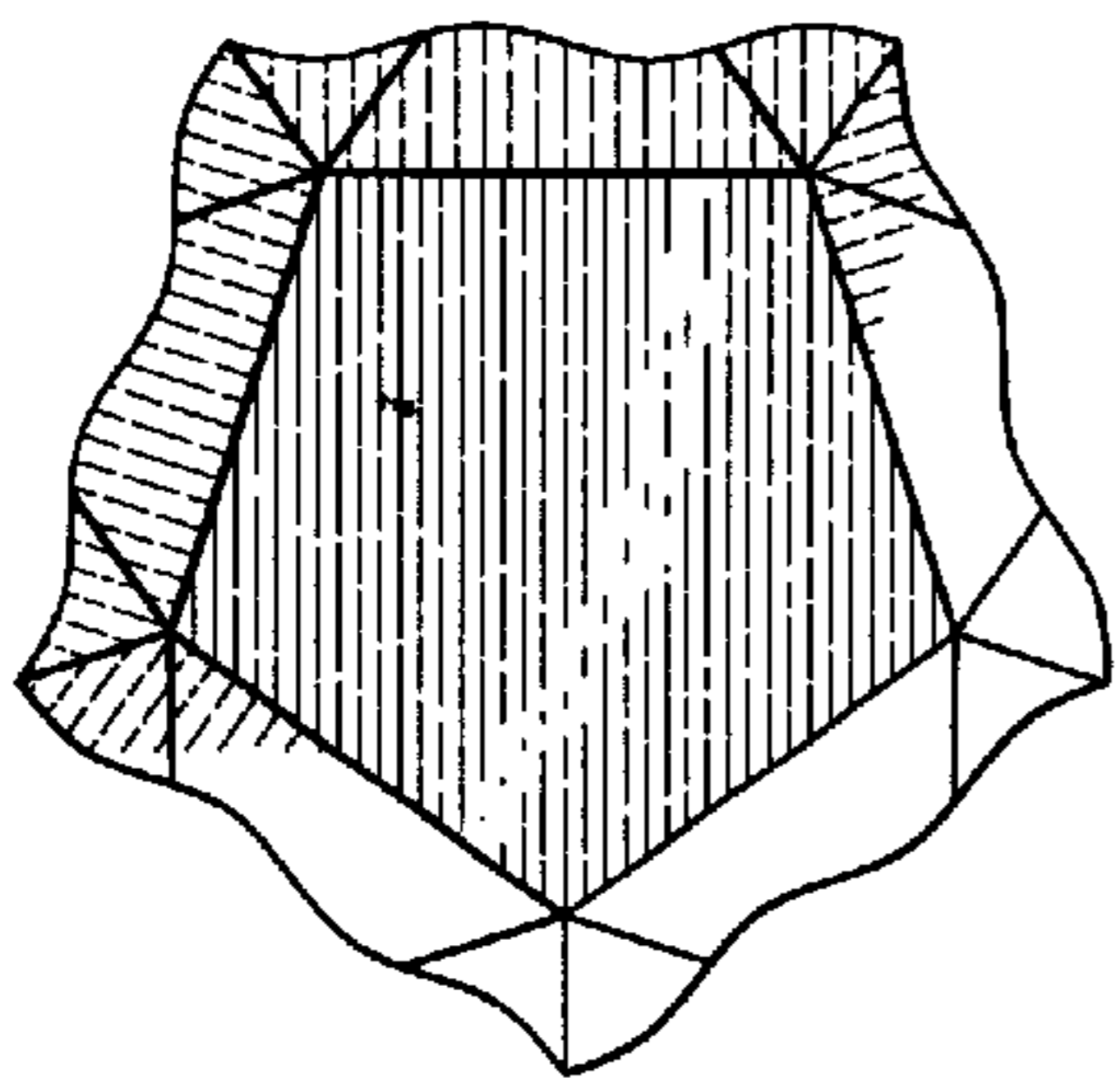

FIG. 3

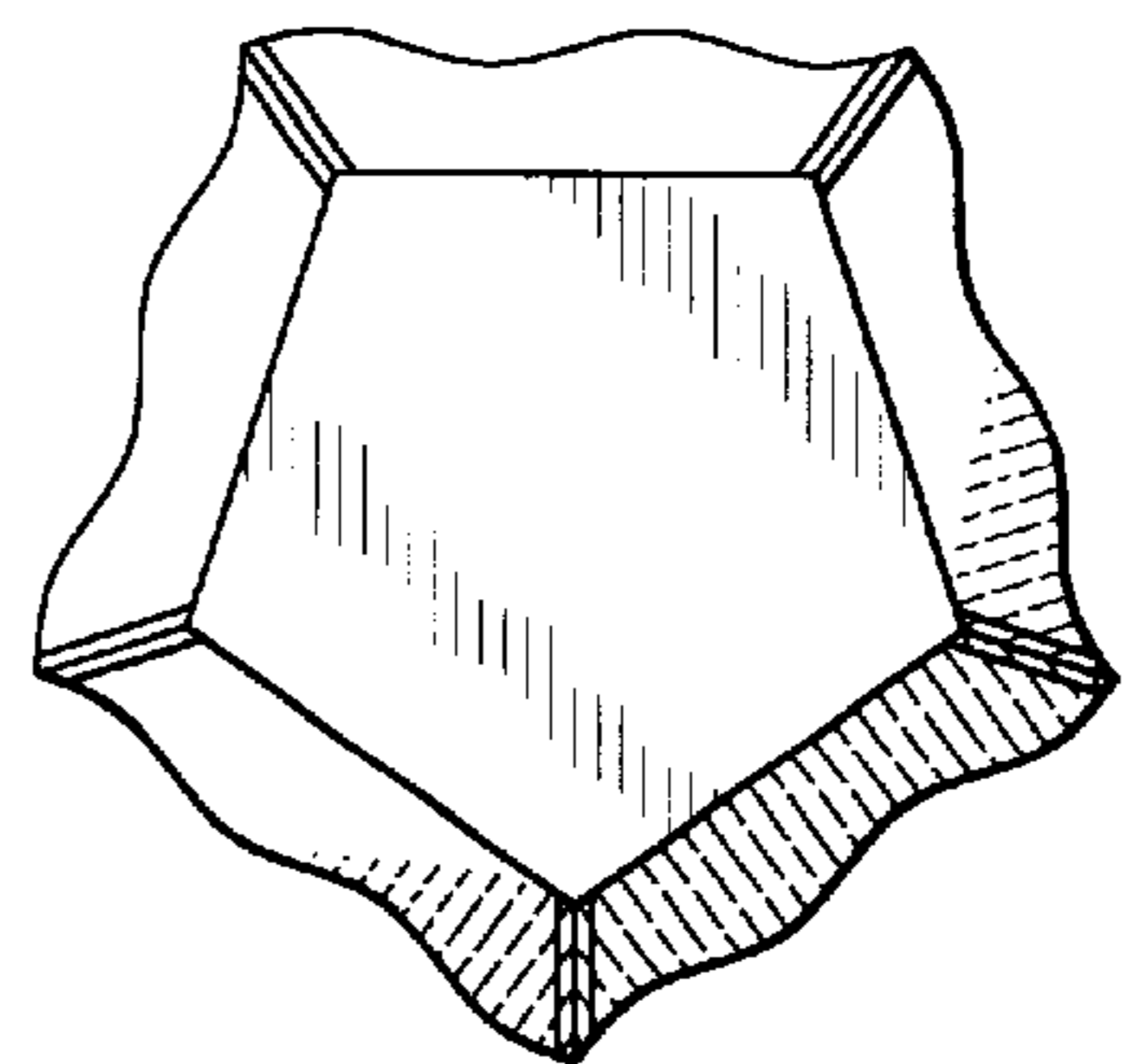

FIG. 4

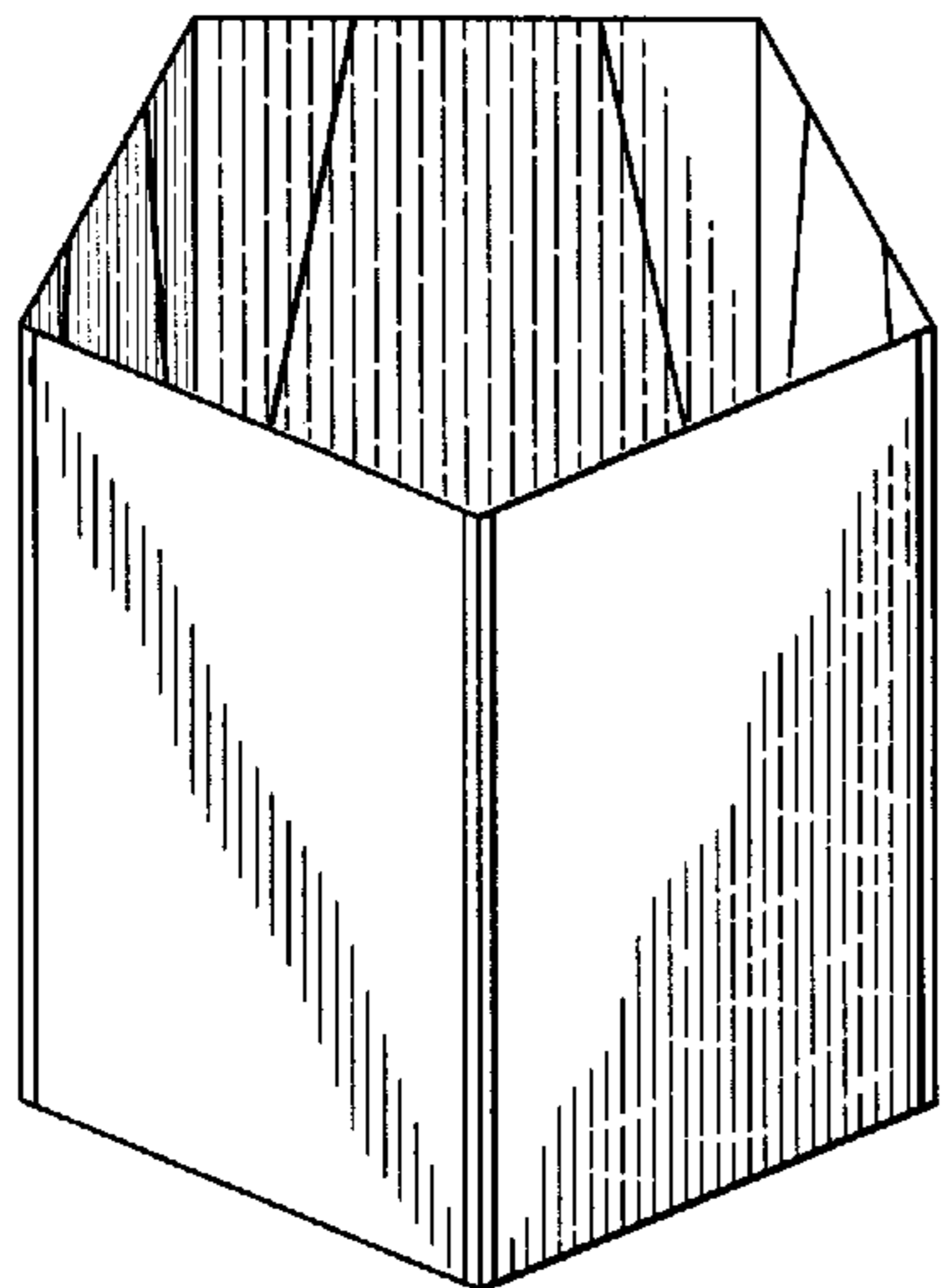

FIG. 5

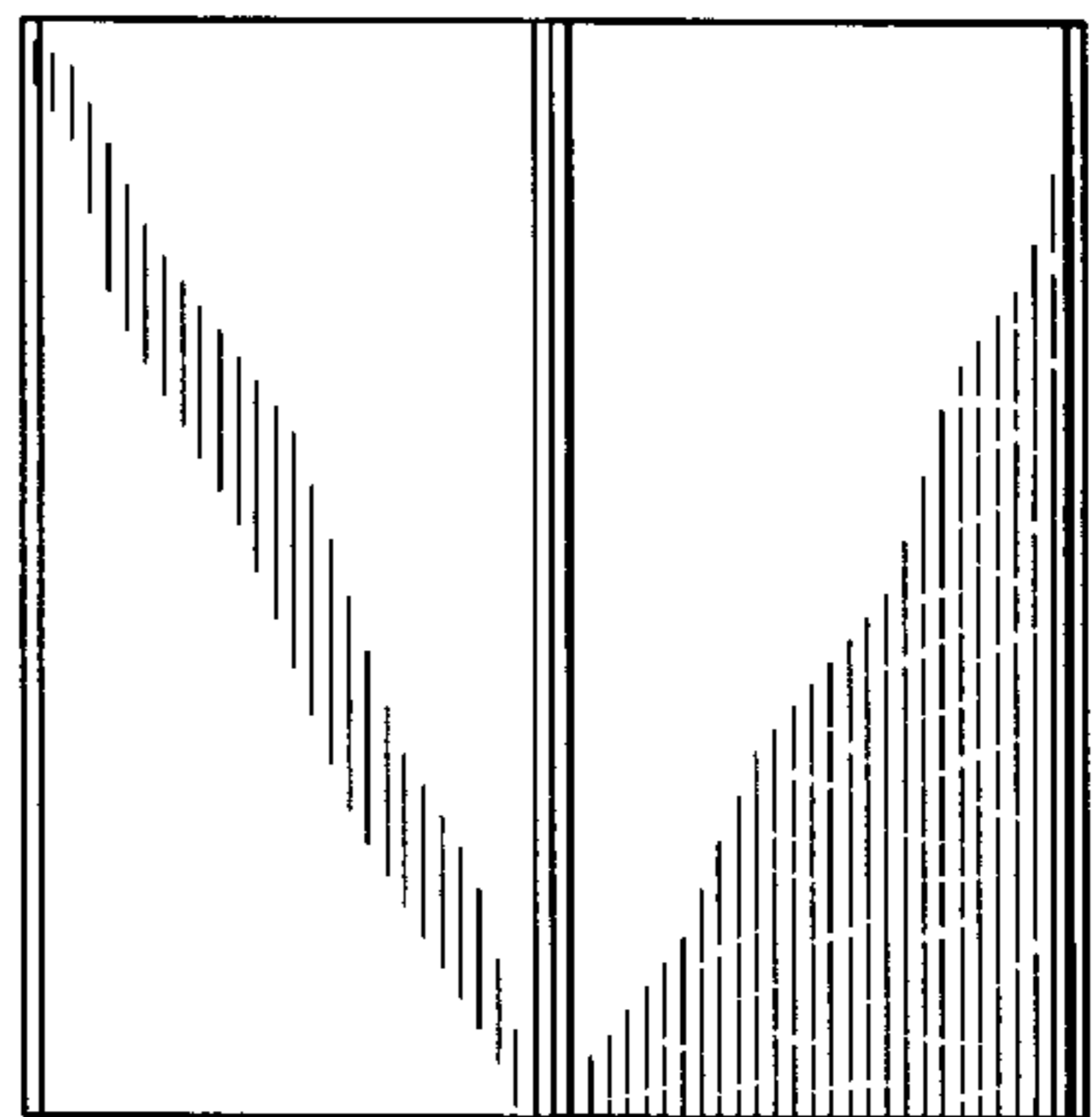

FIG. 6

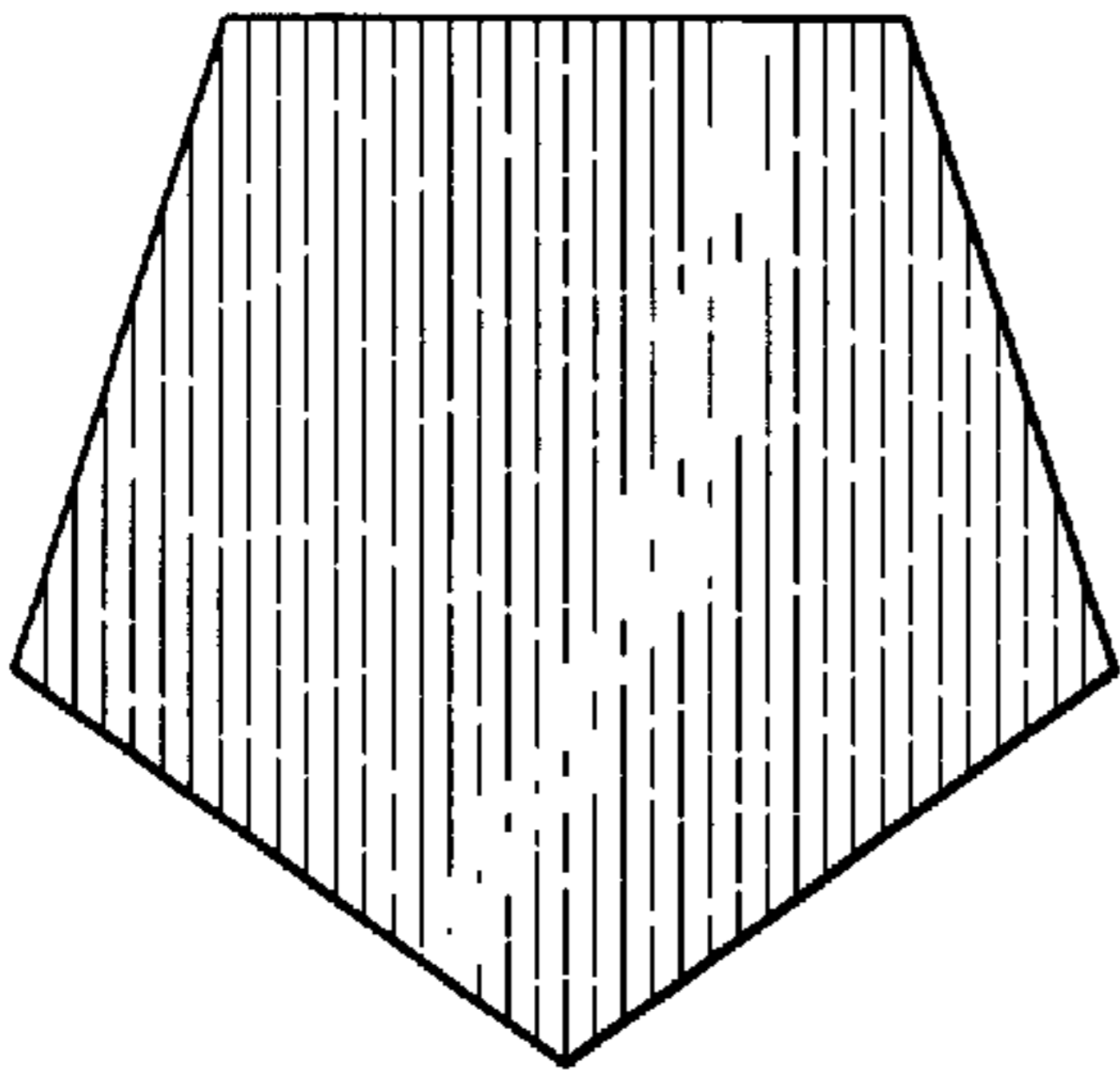

FIG. 7

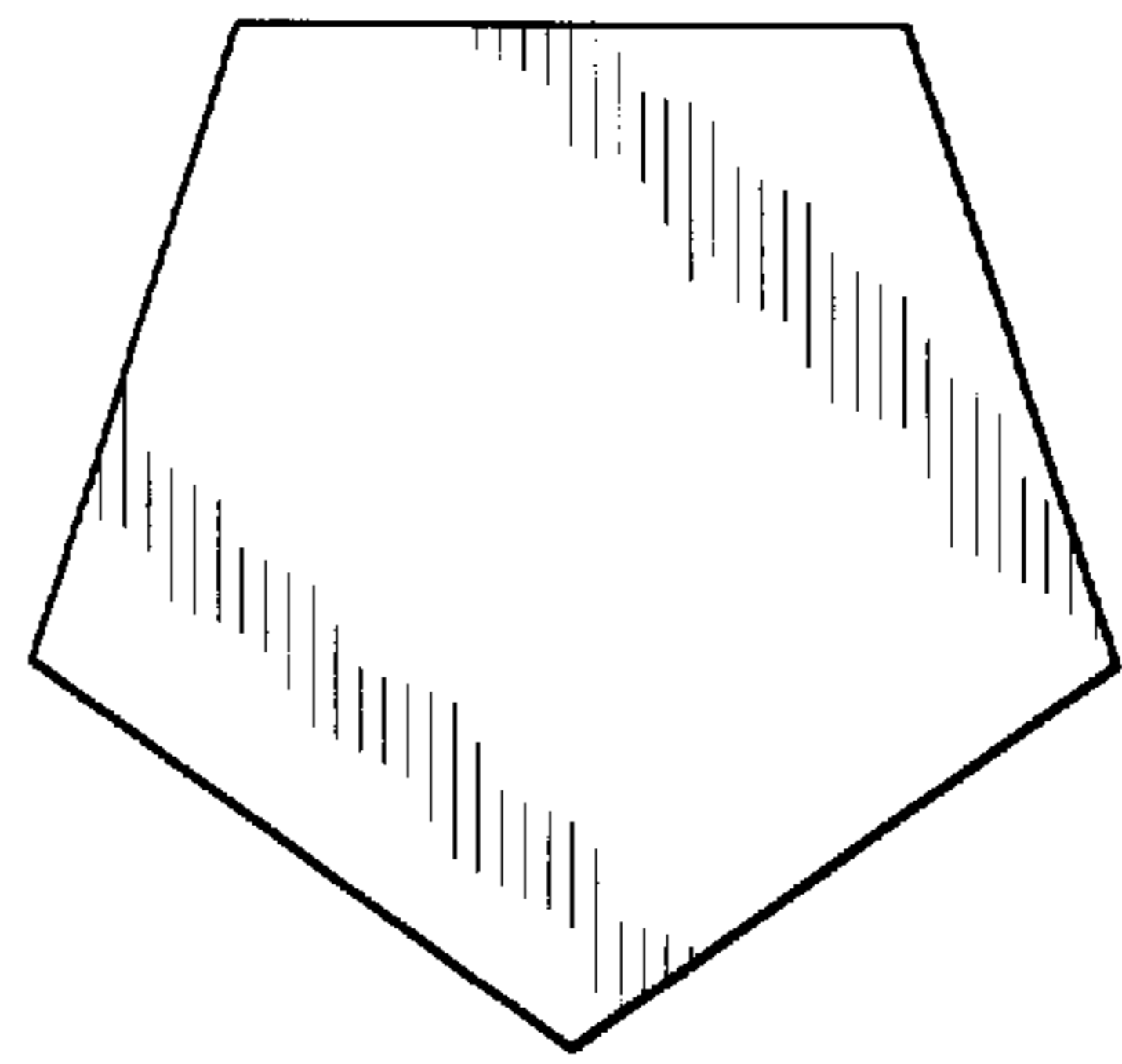

FIG. 8

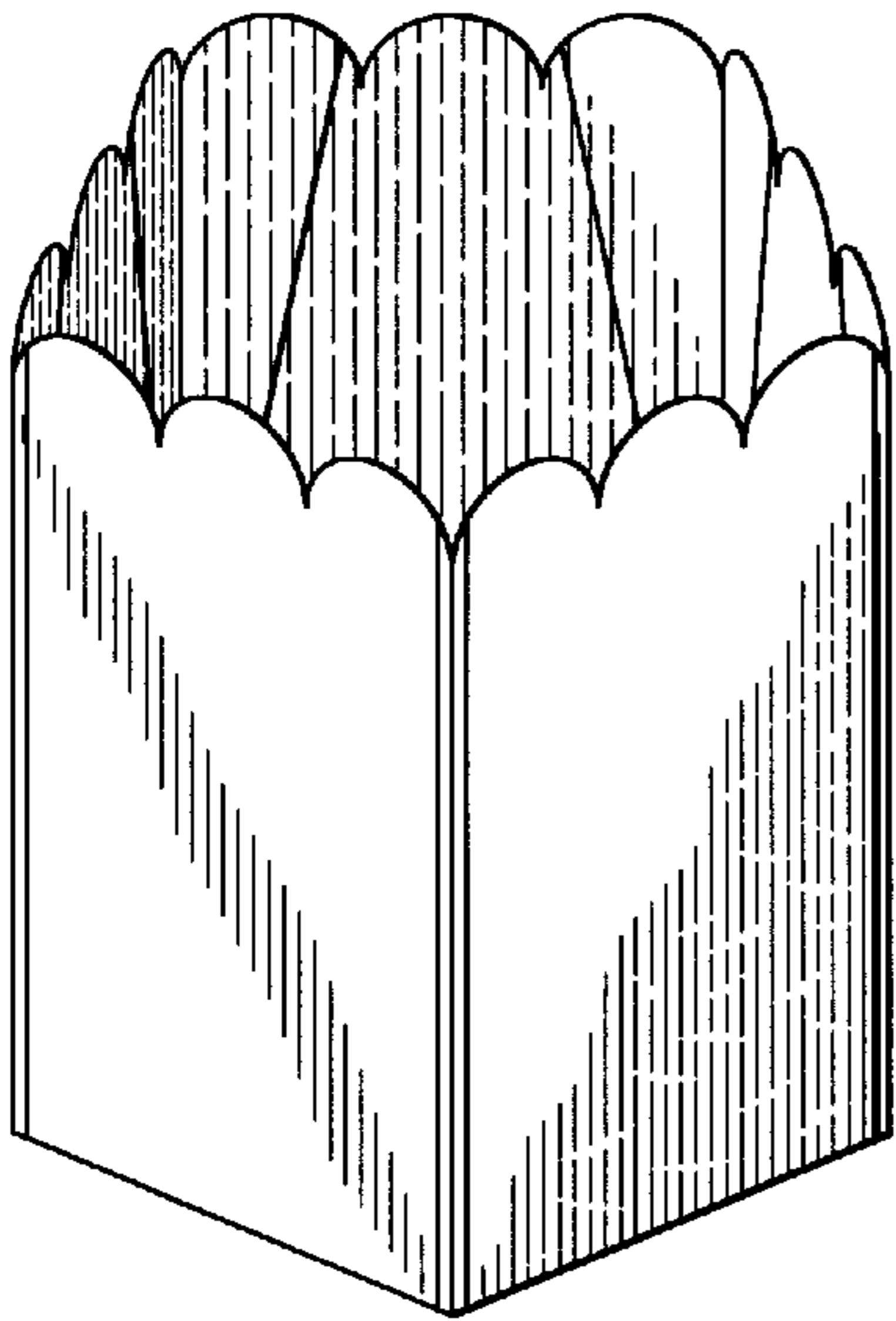

FIG. 9

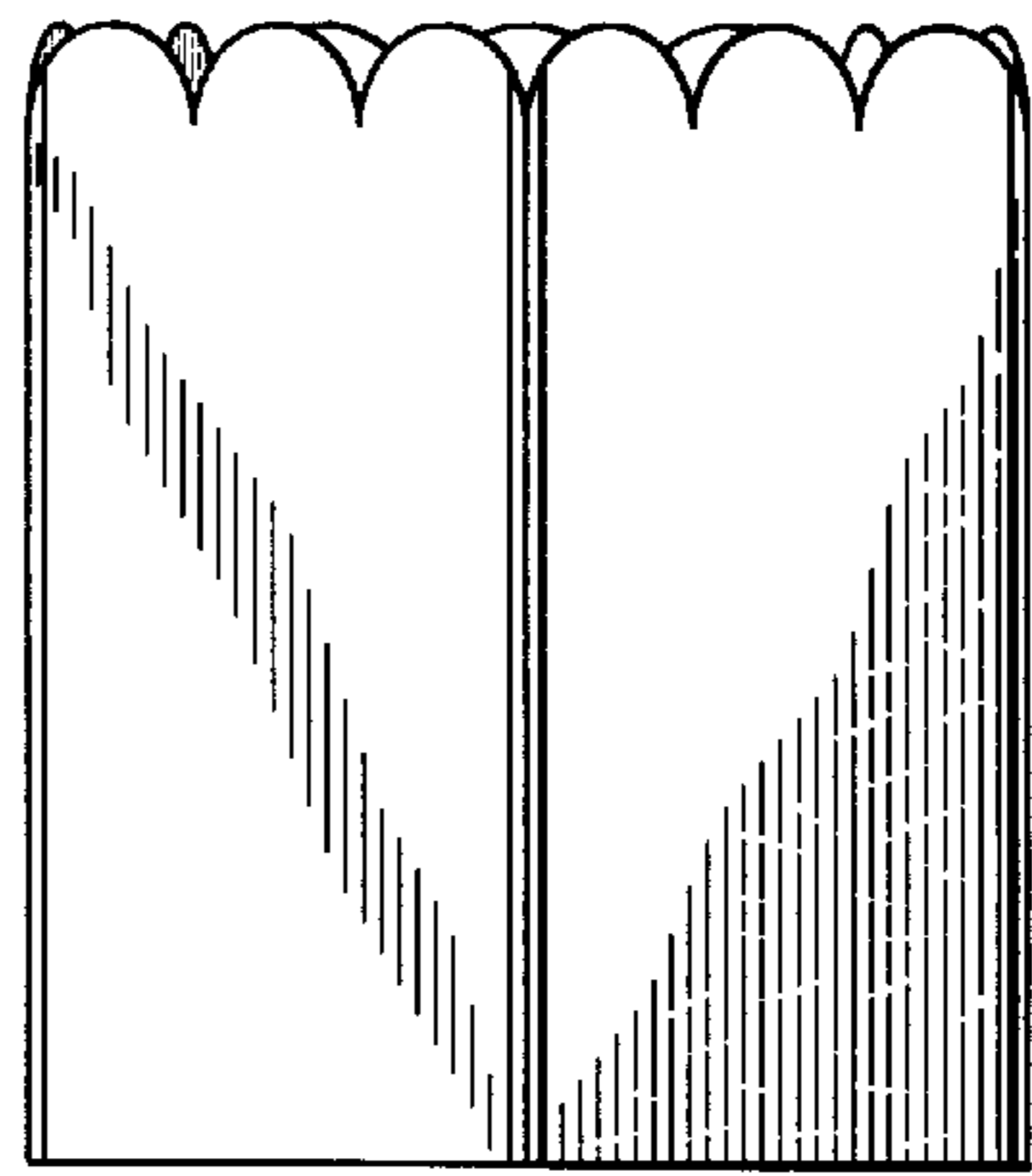

FIG. 10

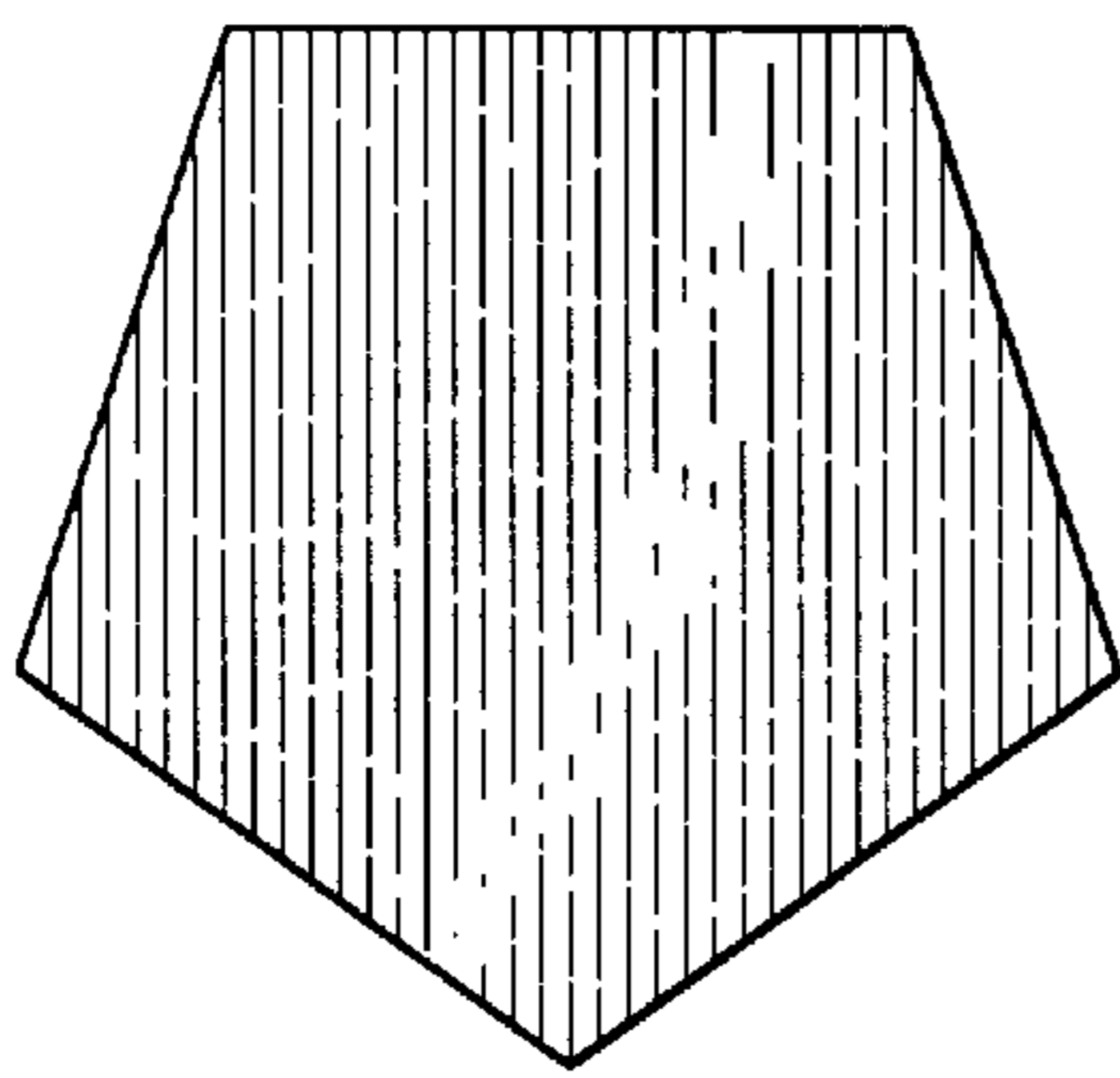

FIG. 11

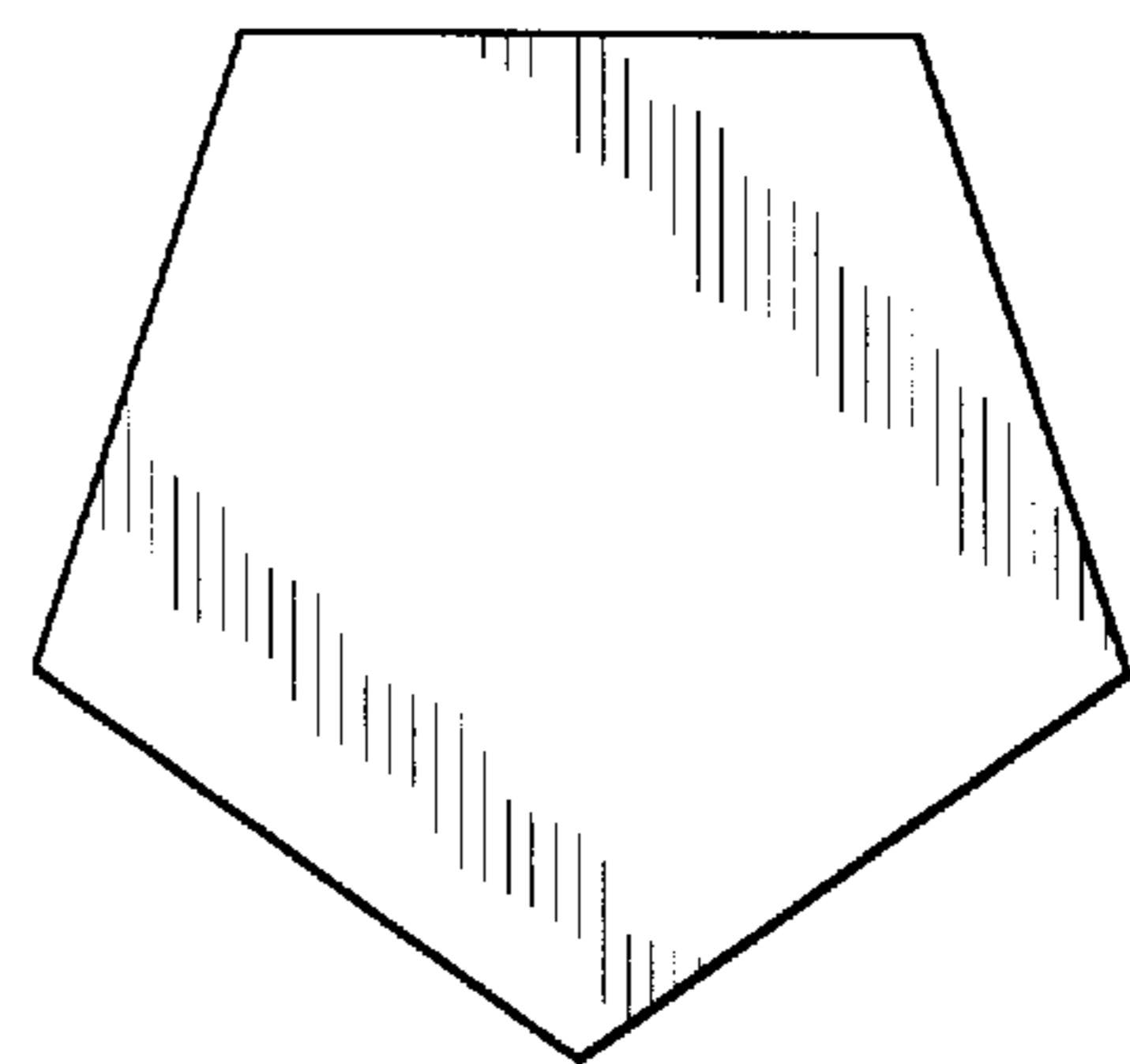

FIG. 12

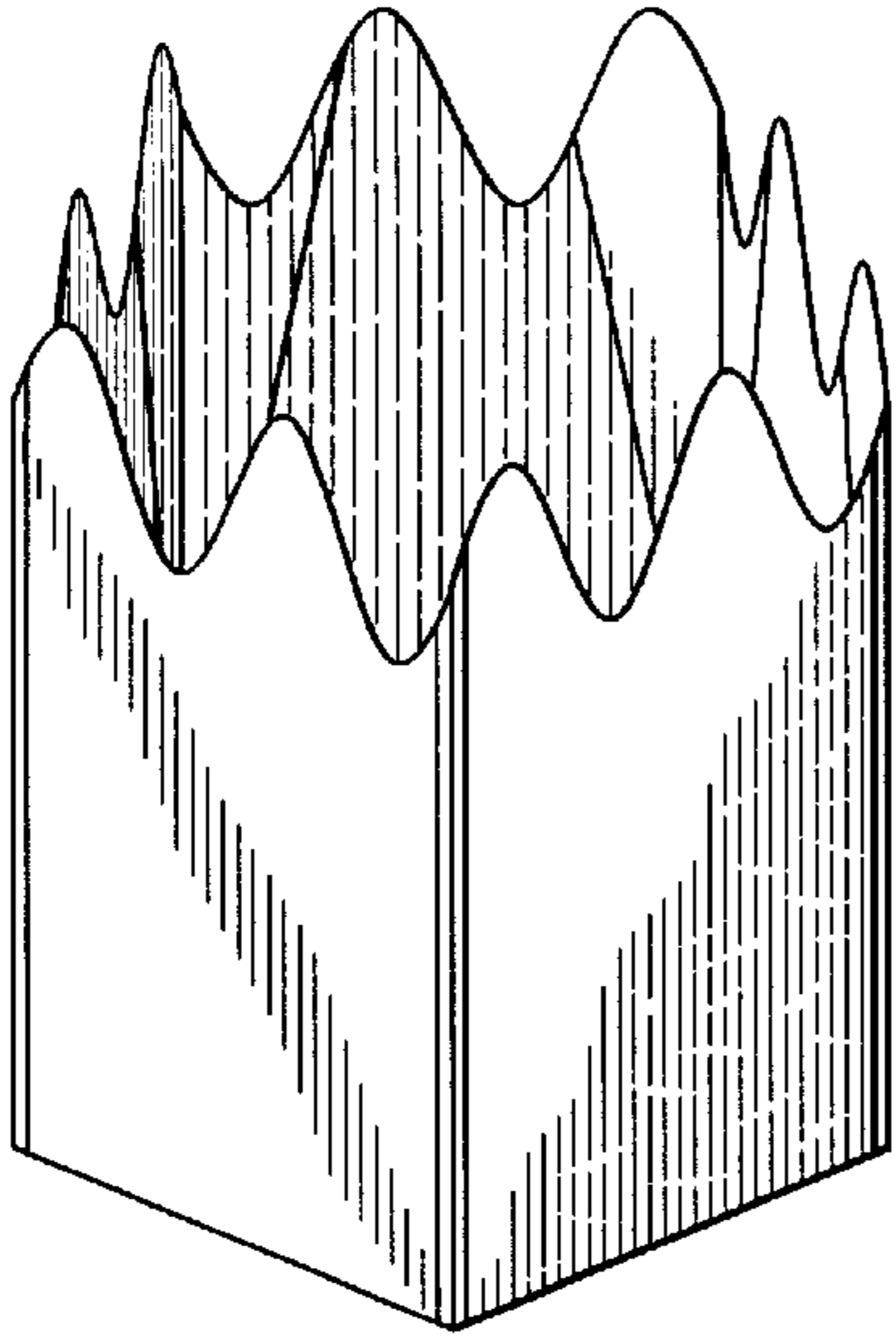

FIG. 13

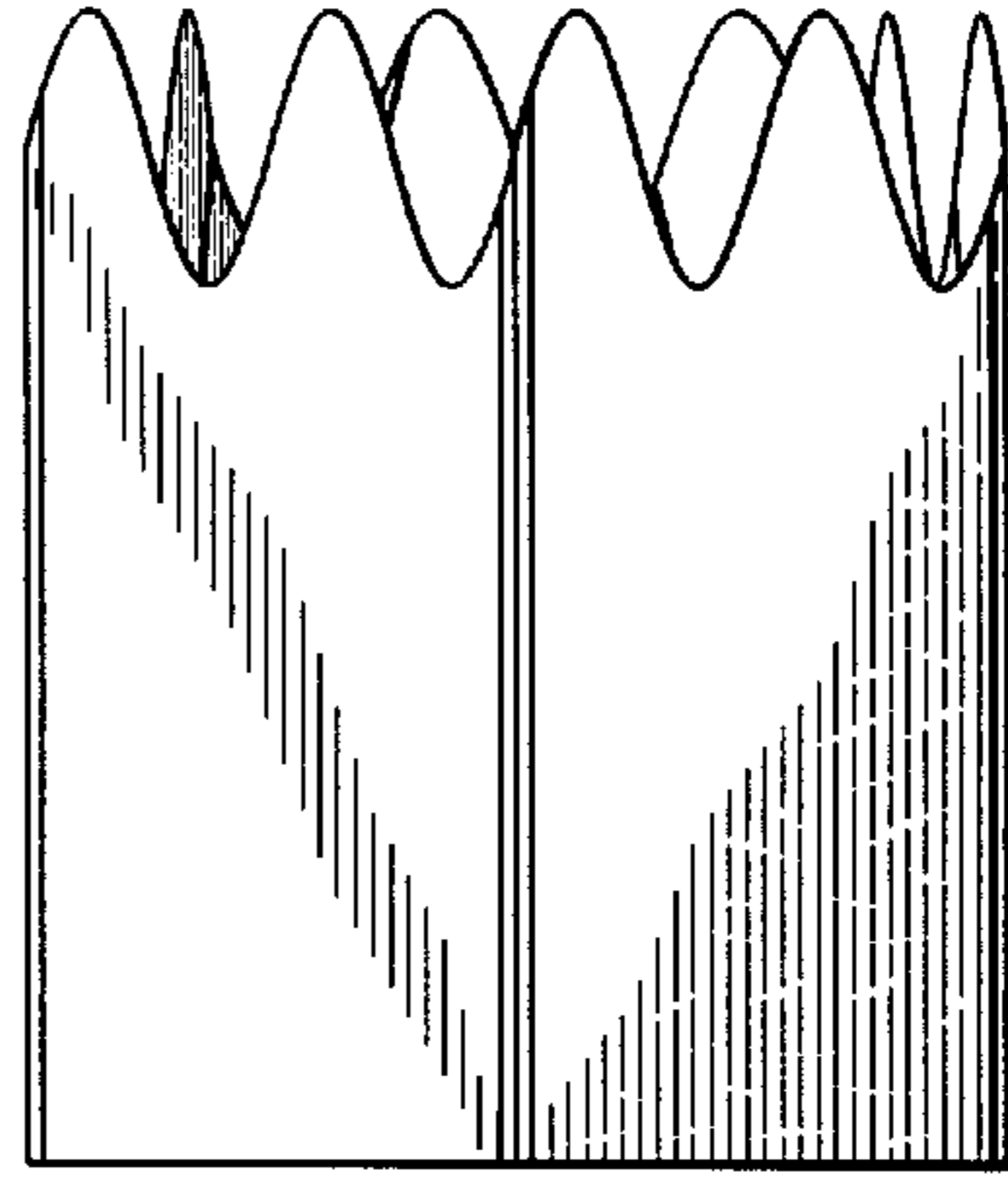

FIG. 14

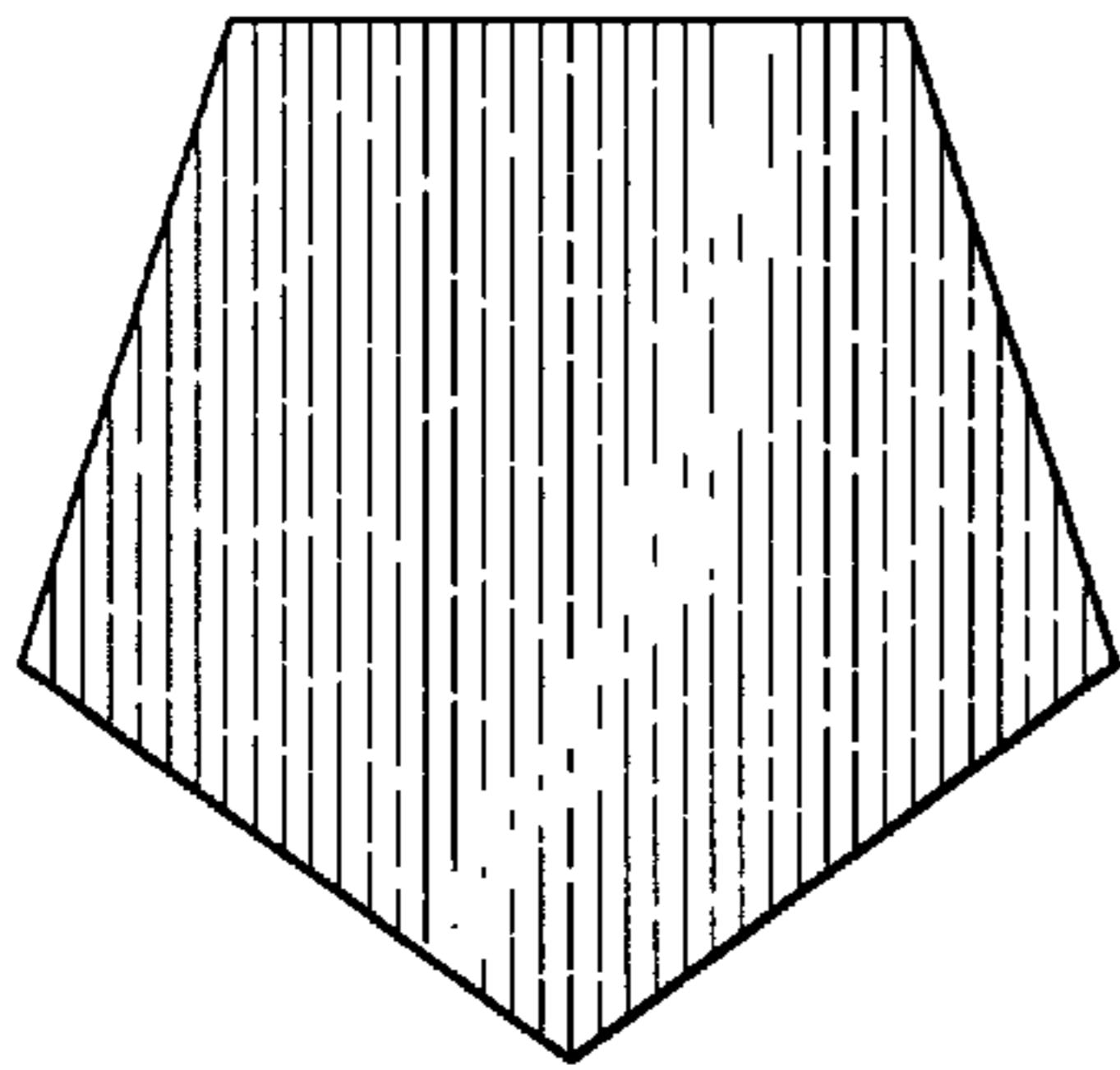

FIG. 15

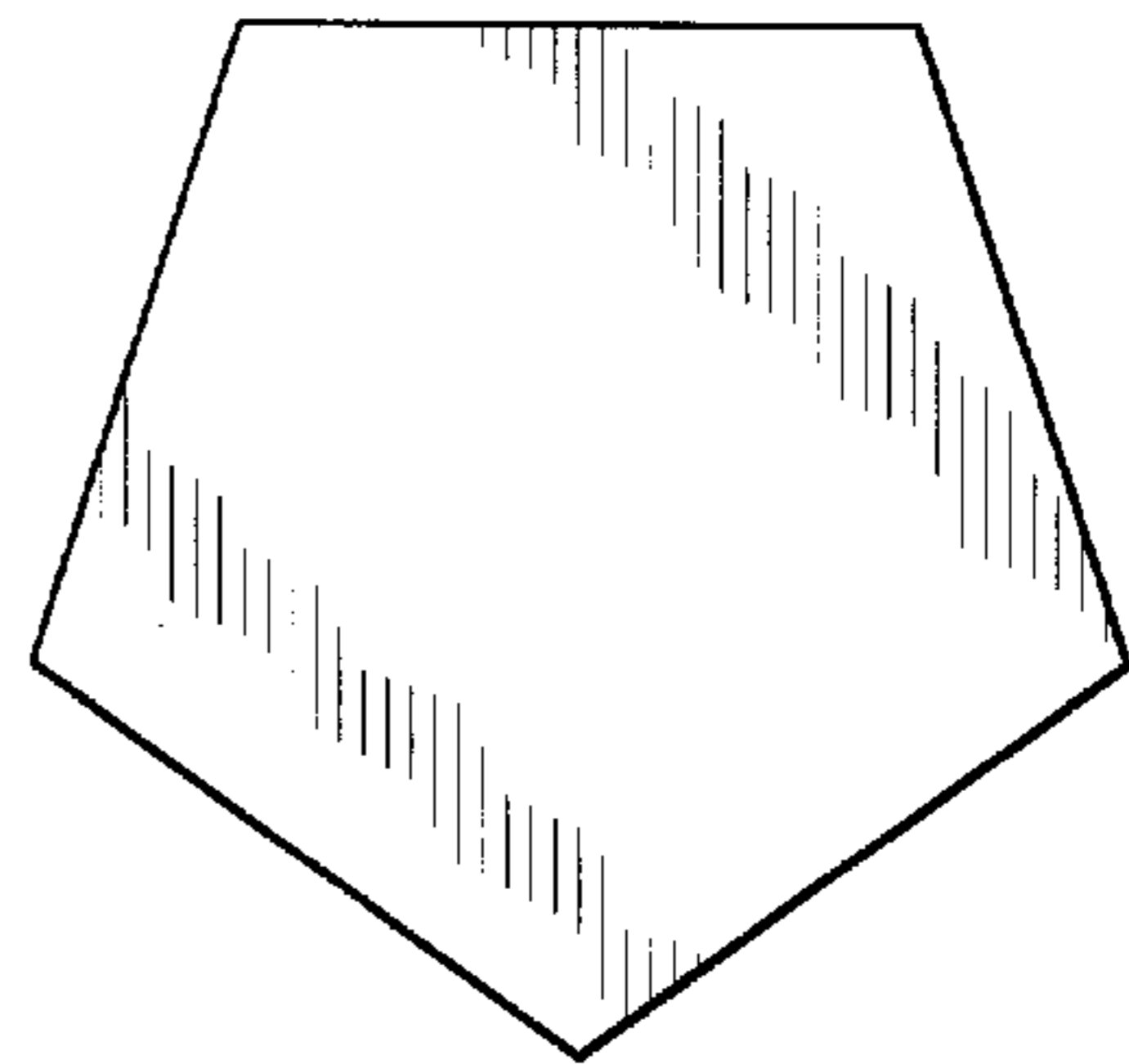

FIG. 16

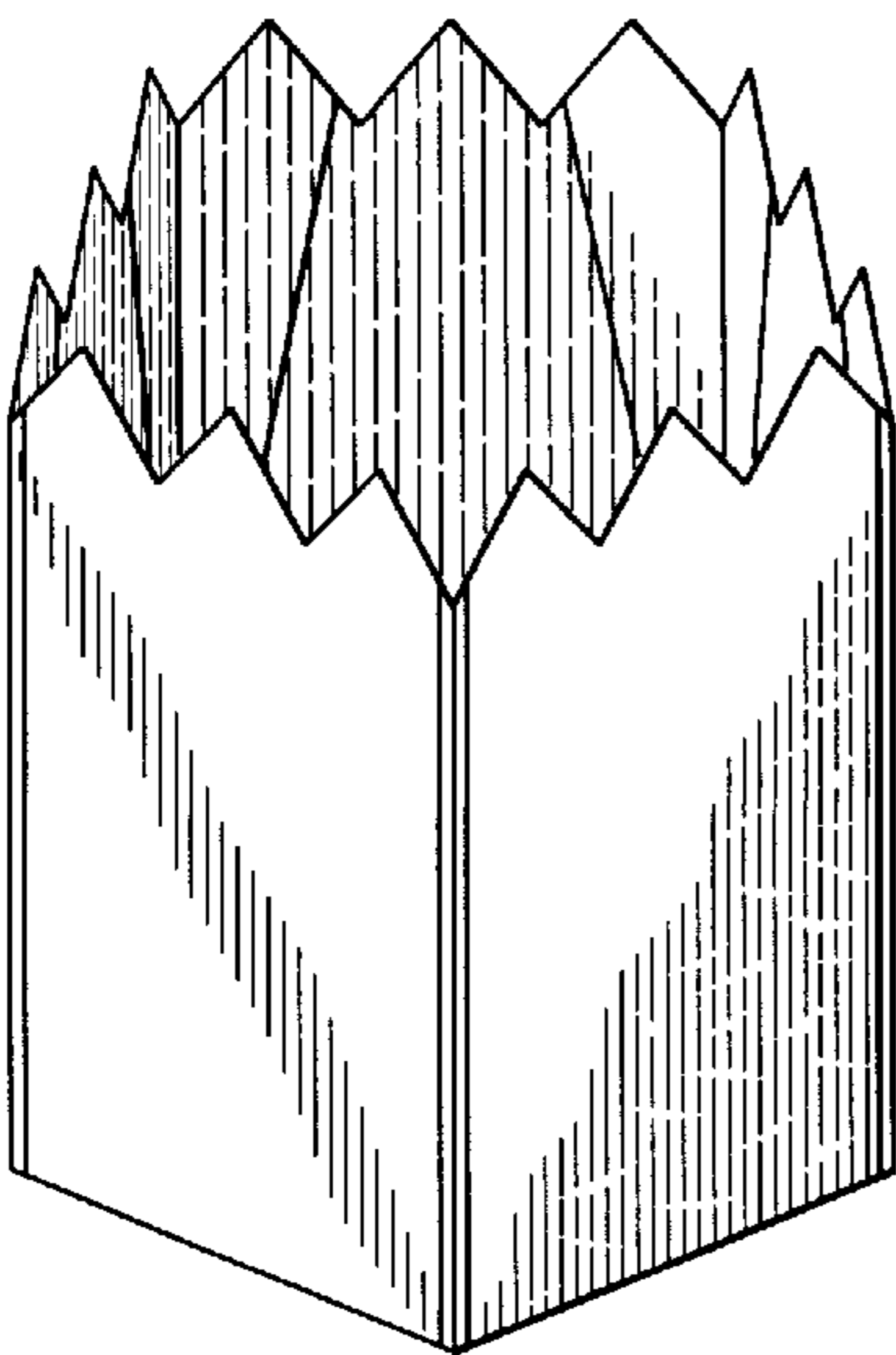

FIG. 17

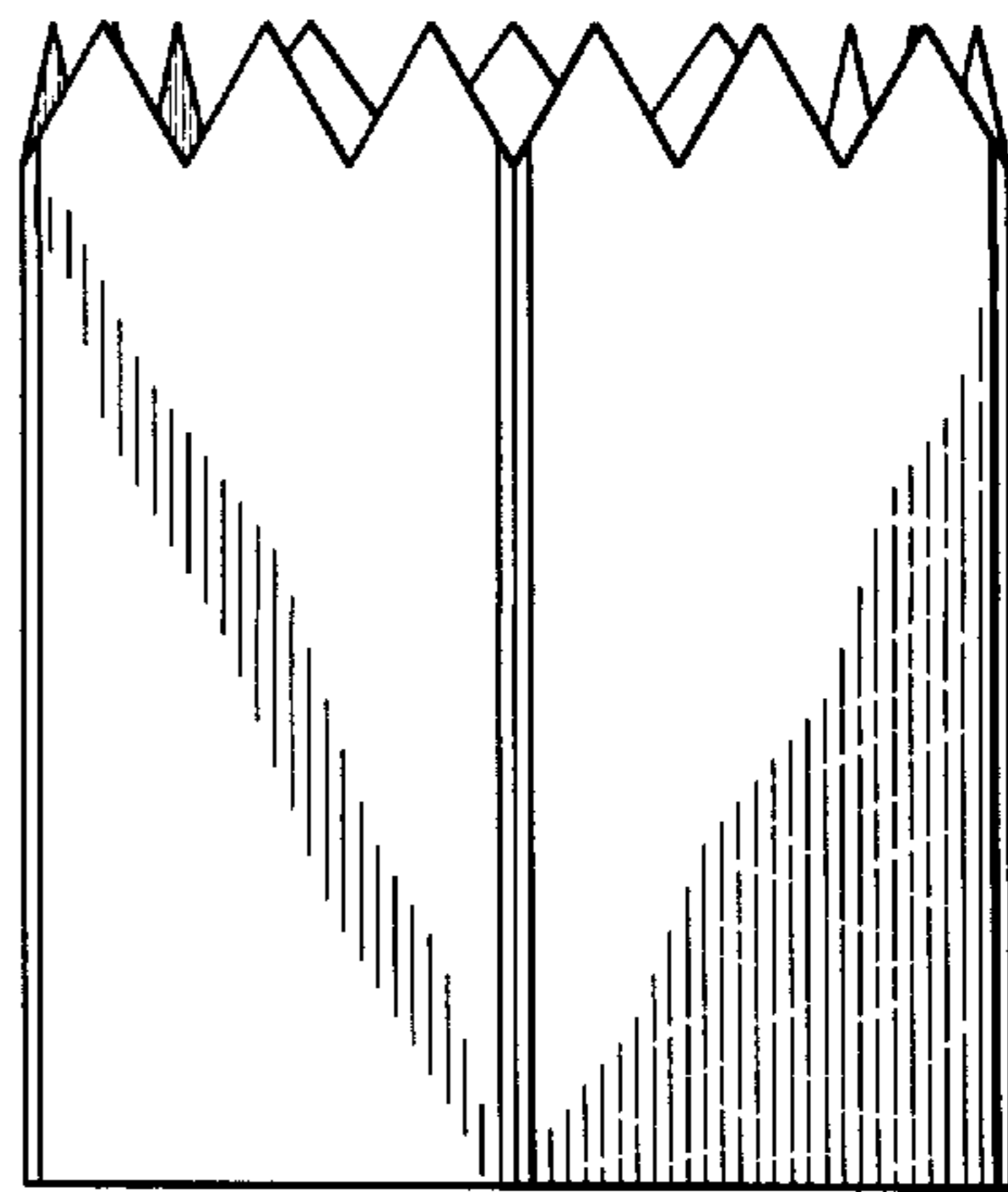

FIG. 18

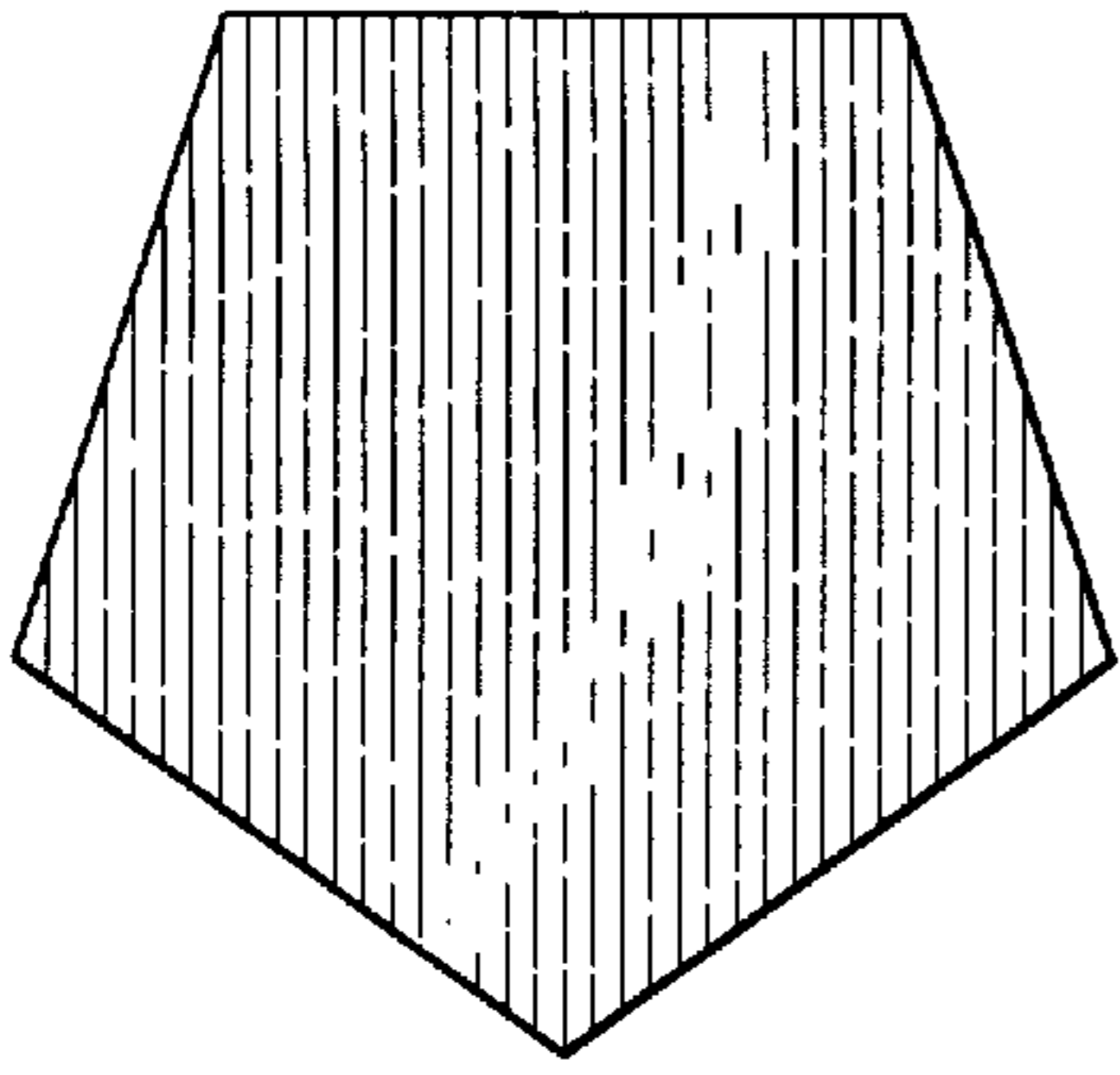

FIG. 19

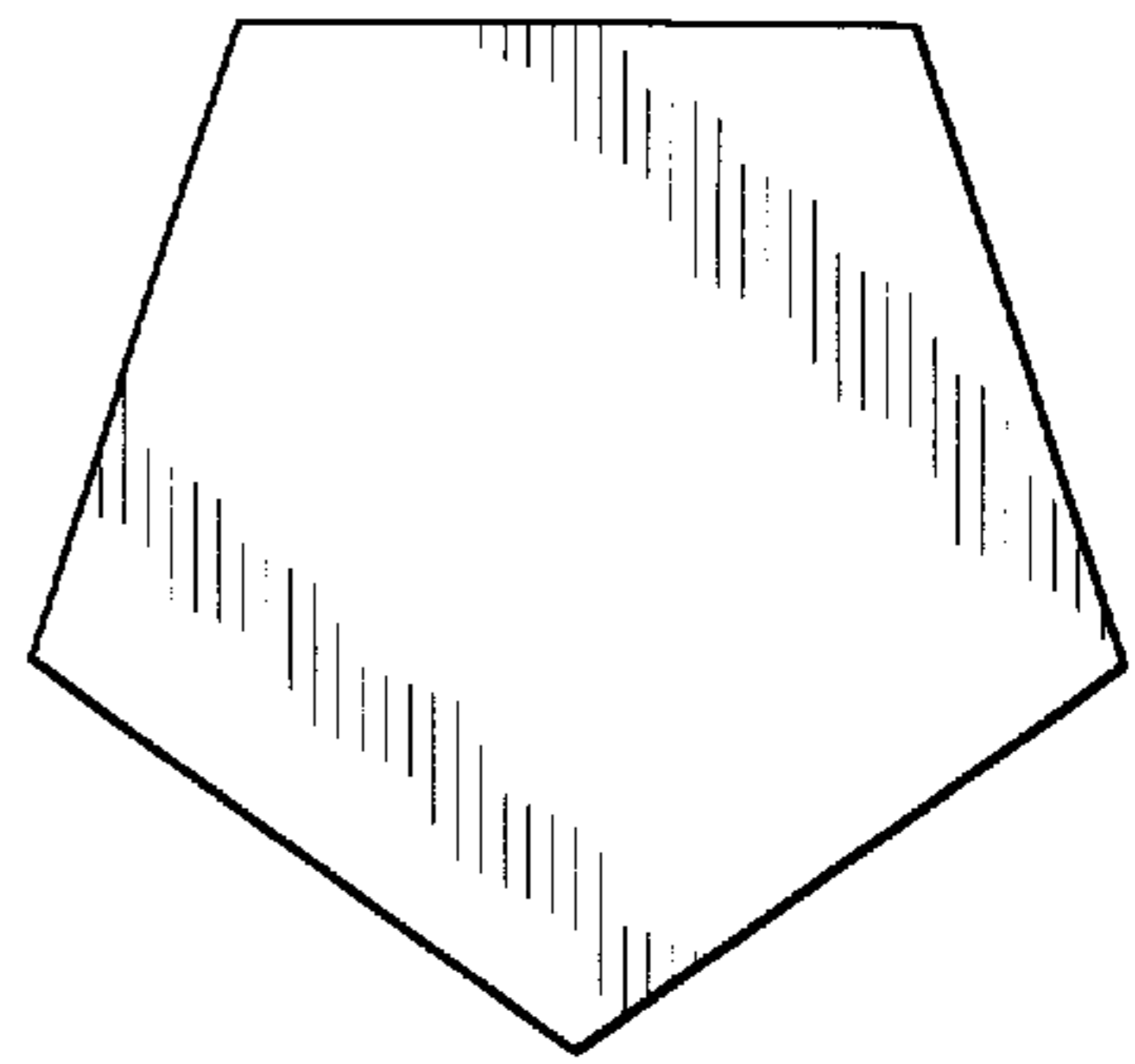

FIG. 20

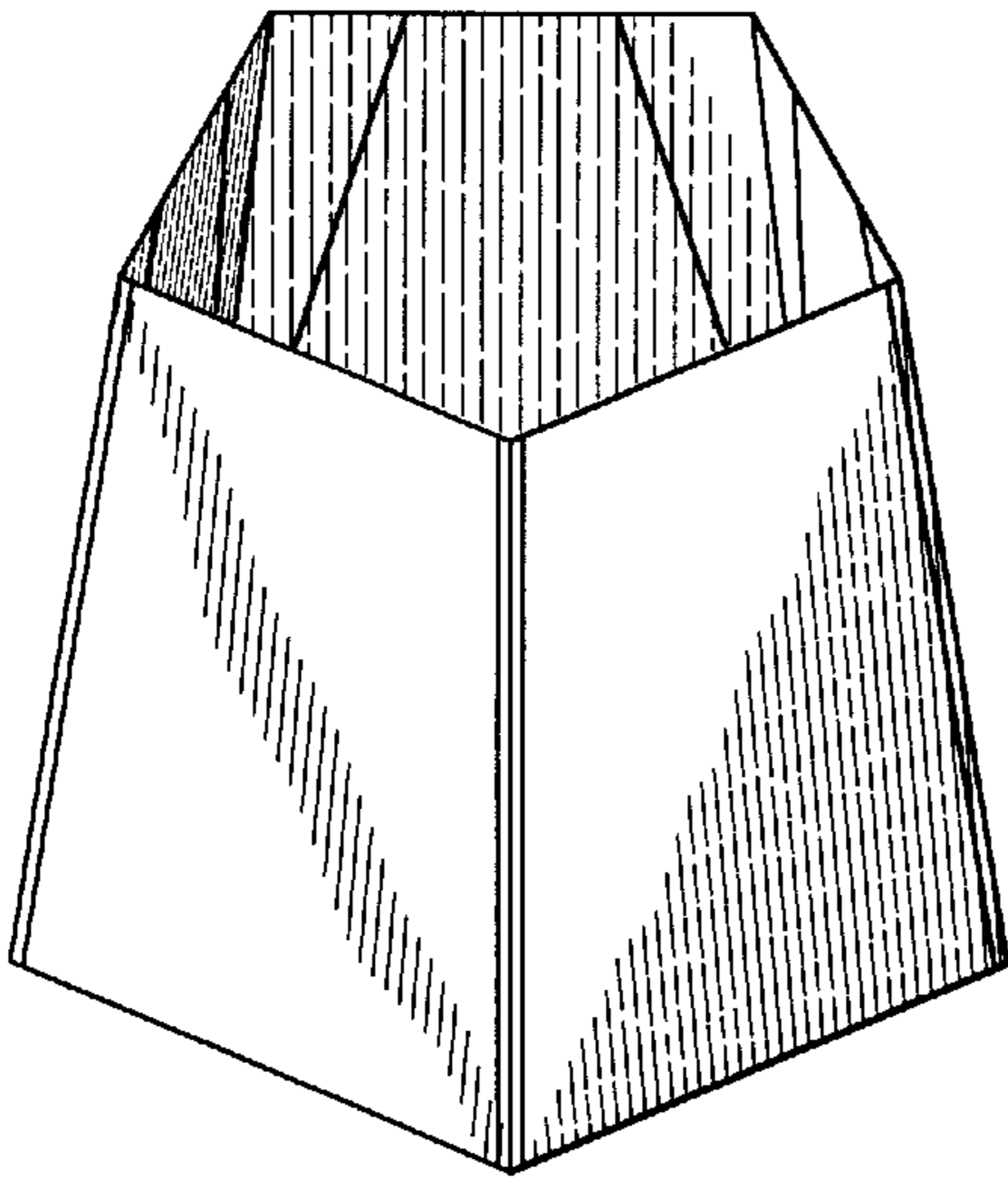

FIG. 21

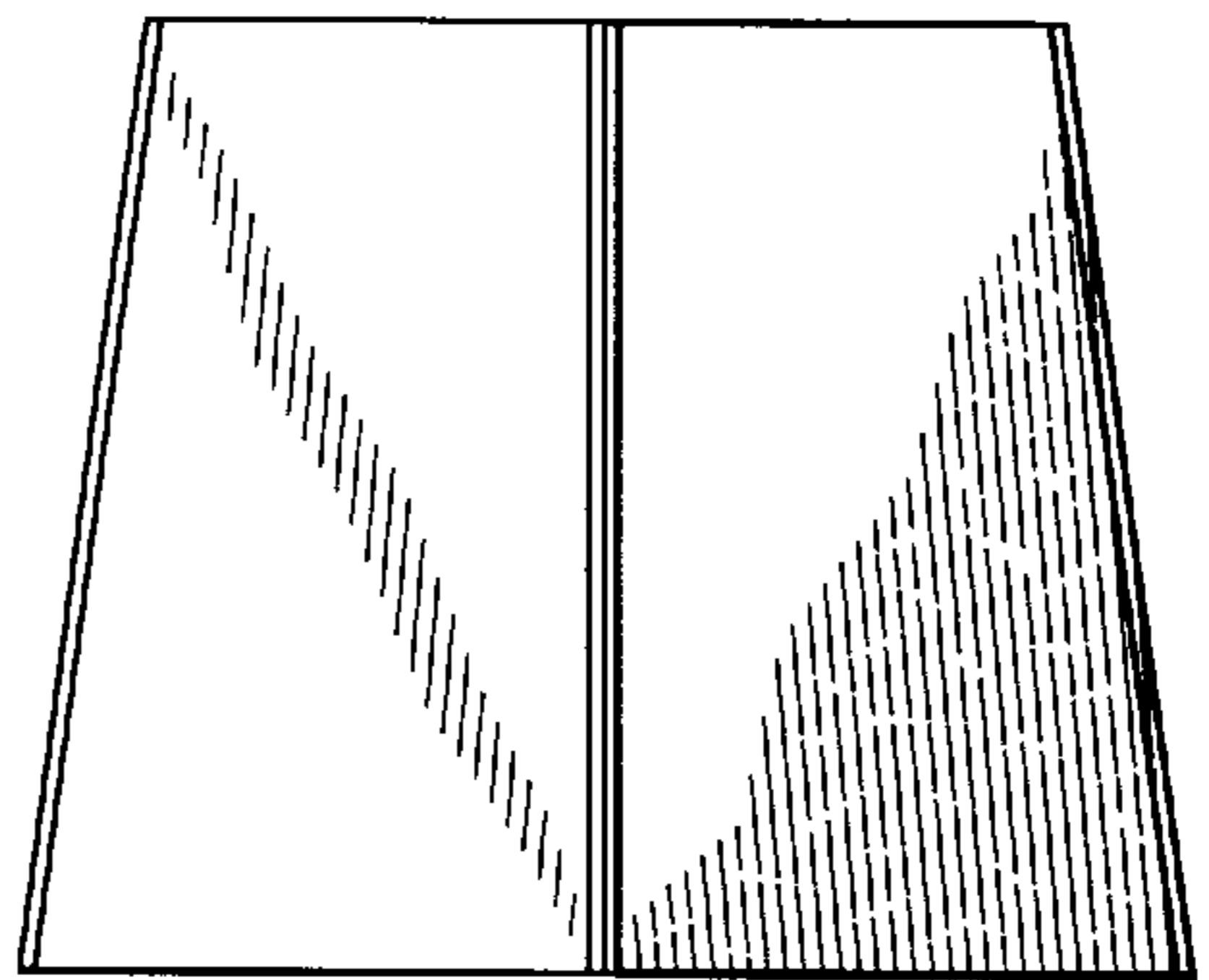

FIG. 22

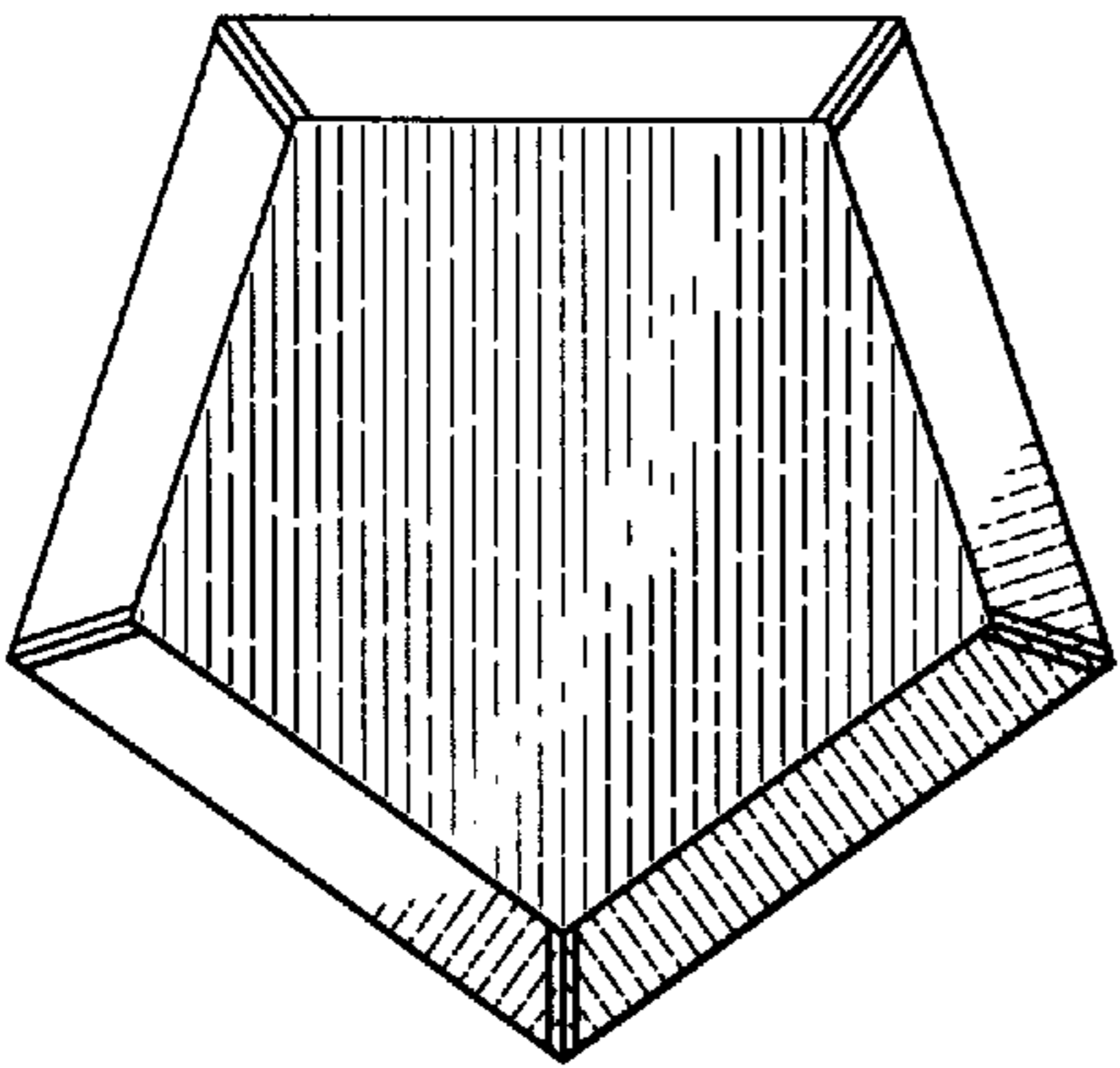

FIG. 23

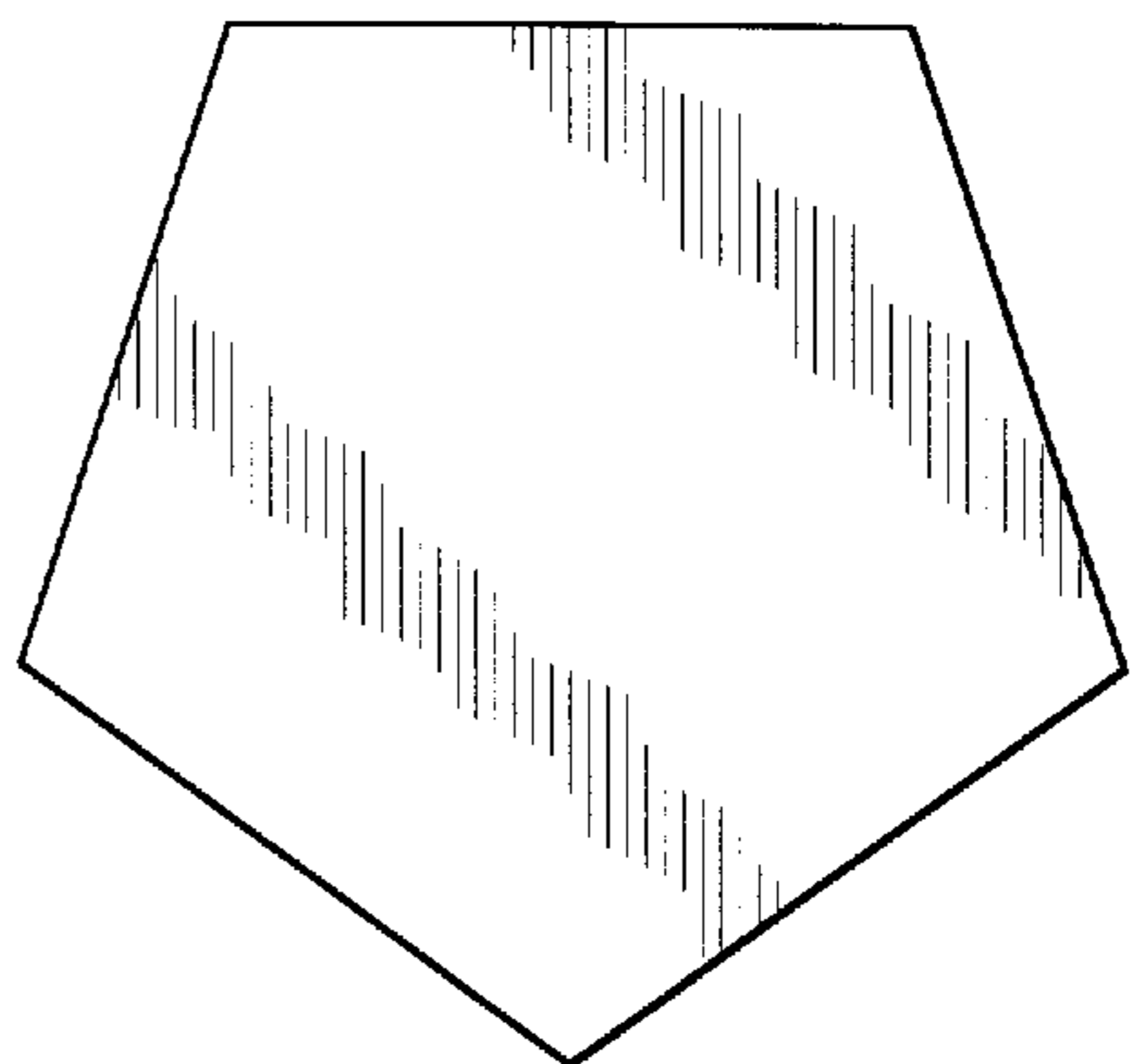

FIG. 24

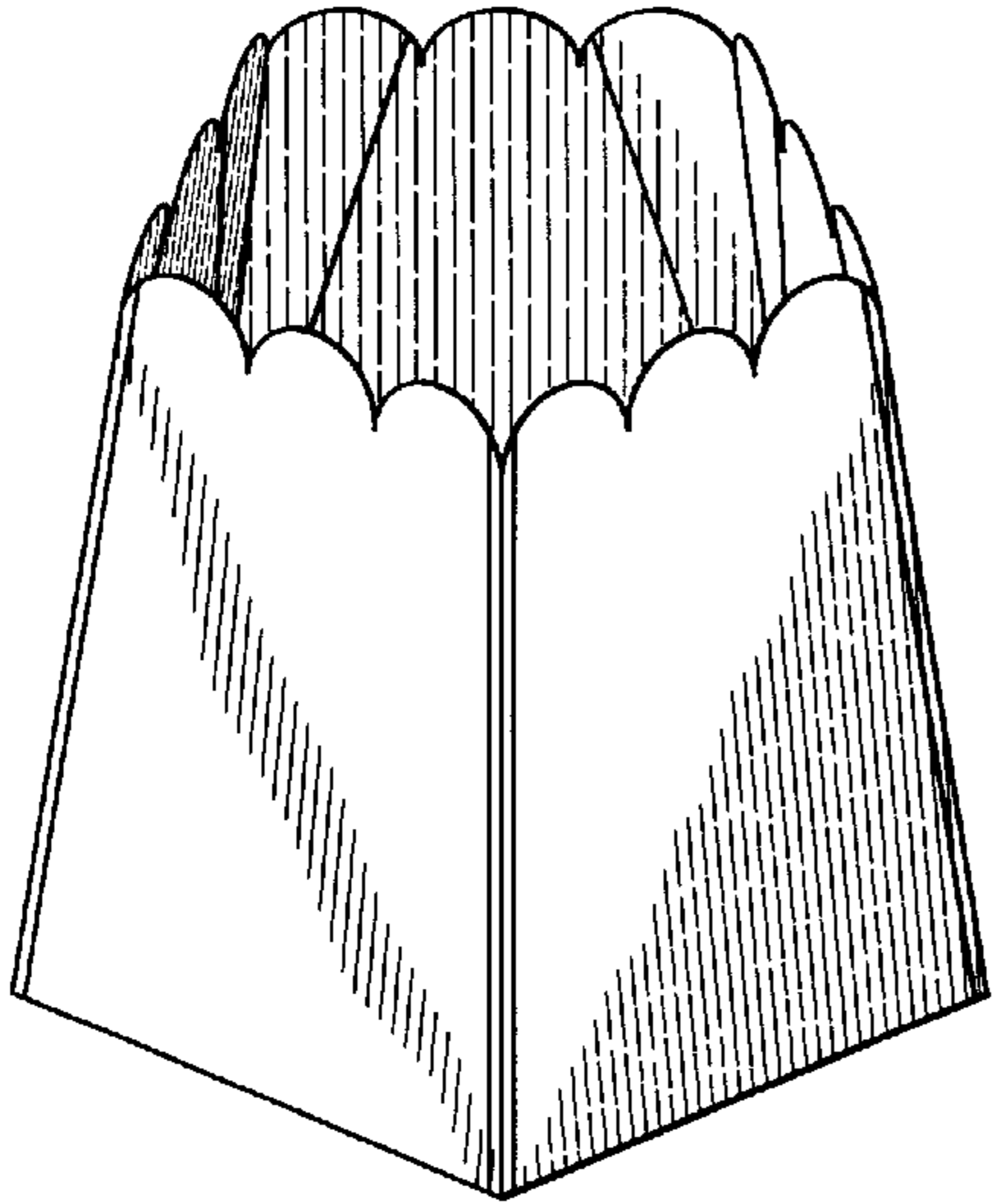

FIG. 25

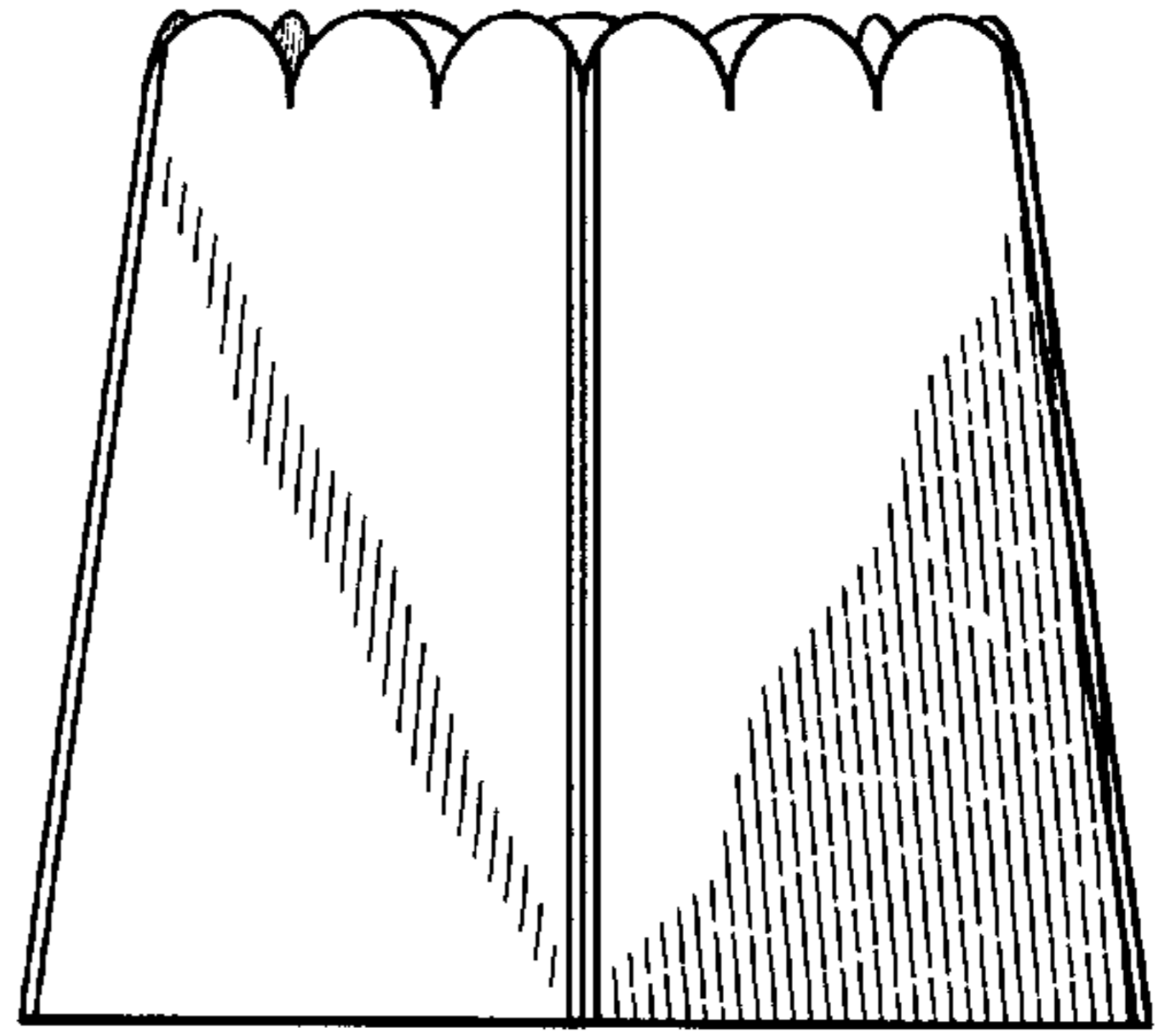

FIG. 26

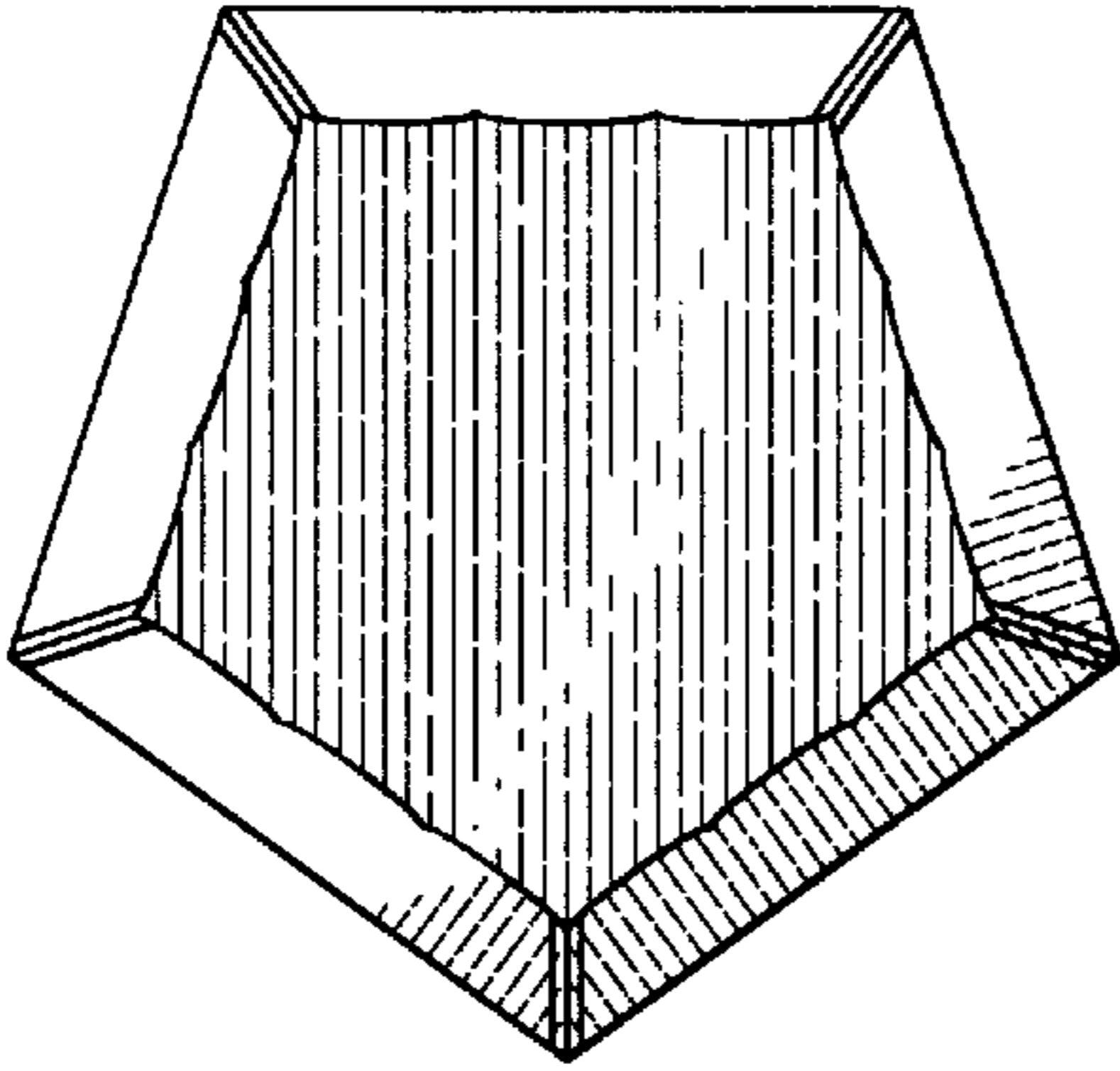

FIG. 27

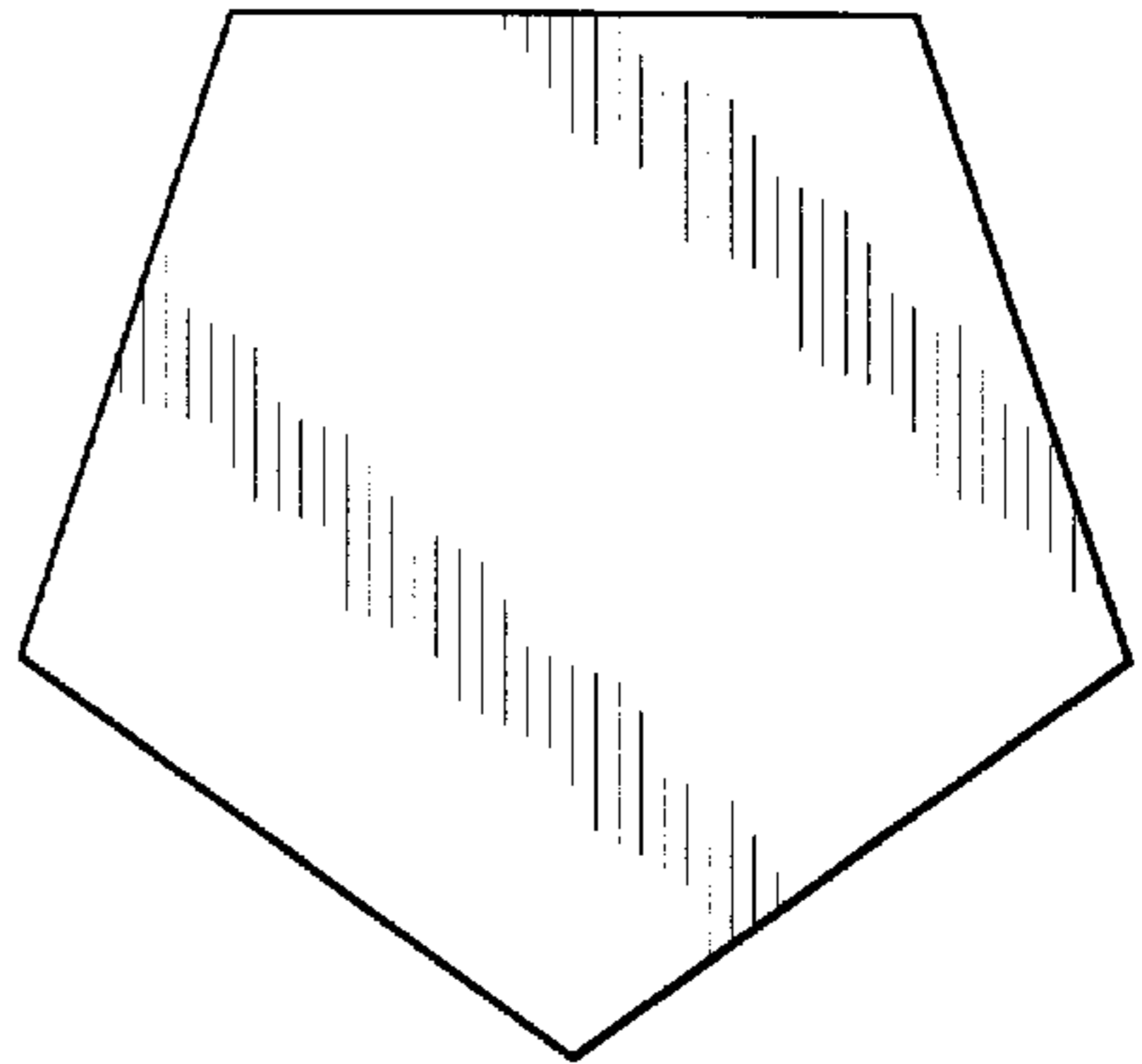

FIG. 28

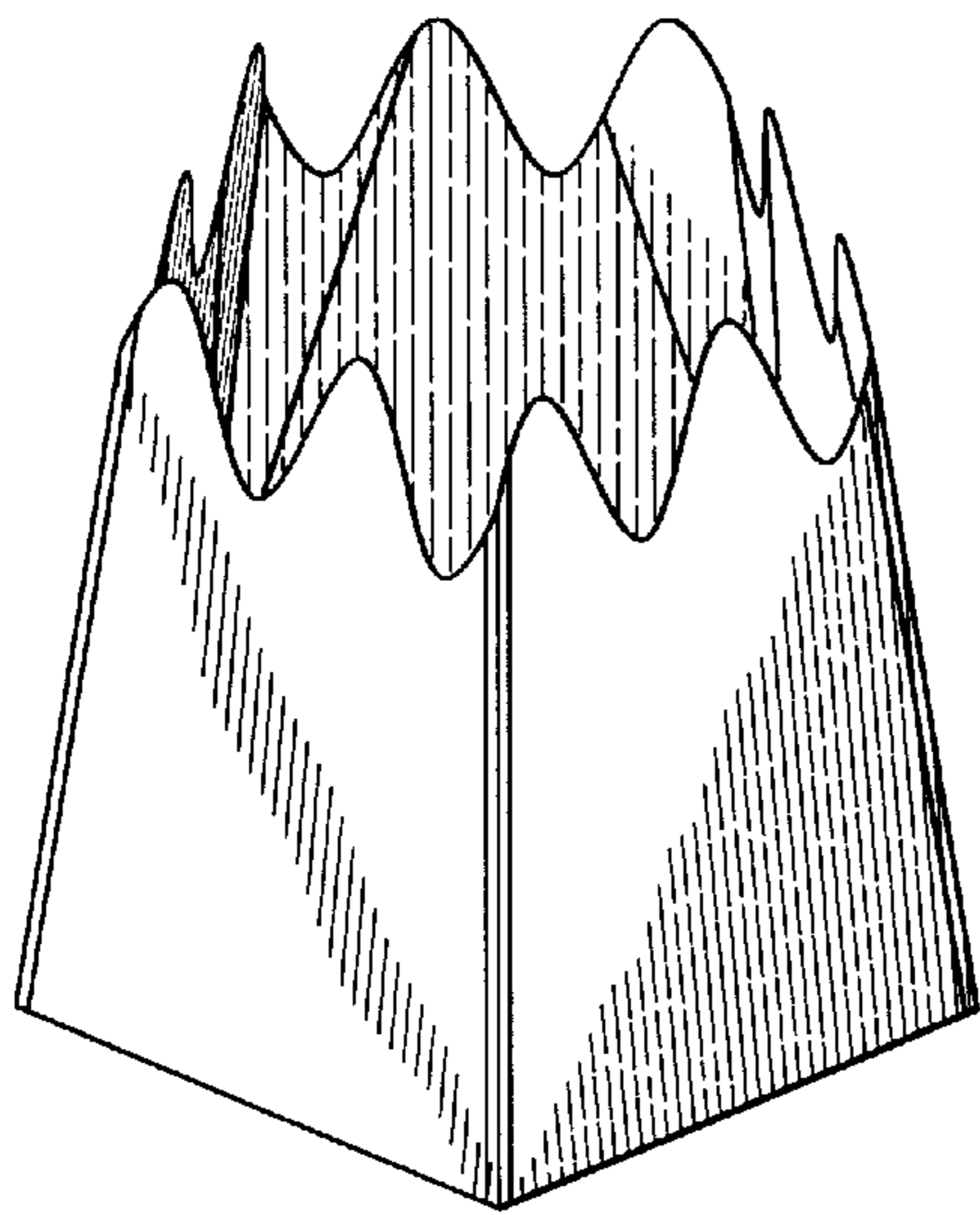

FIG. 29

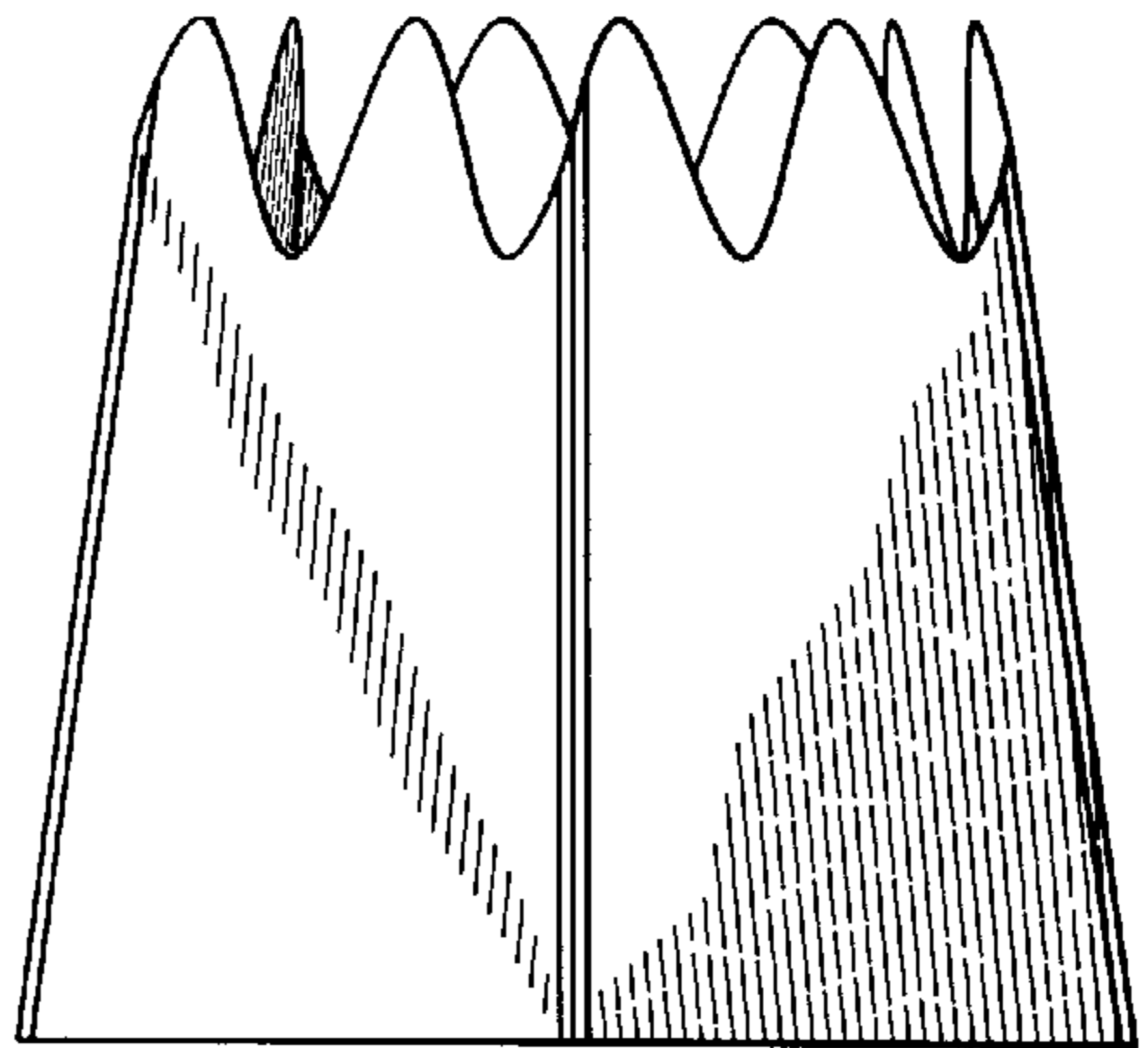

FIG. 30

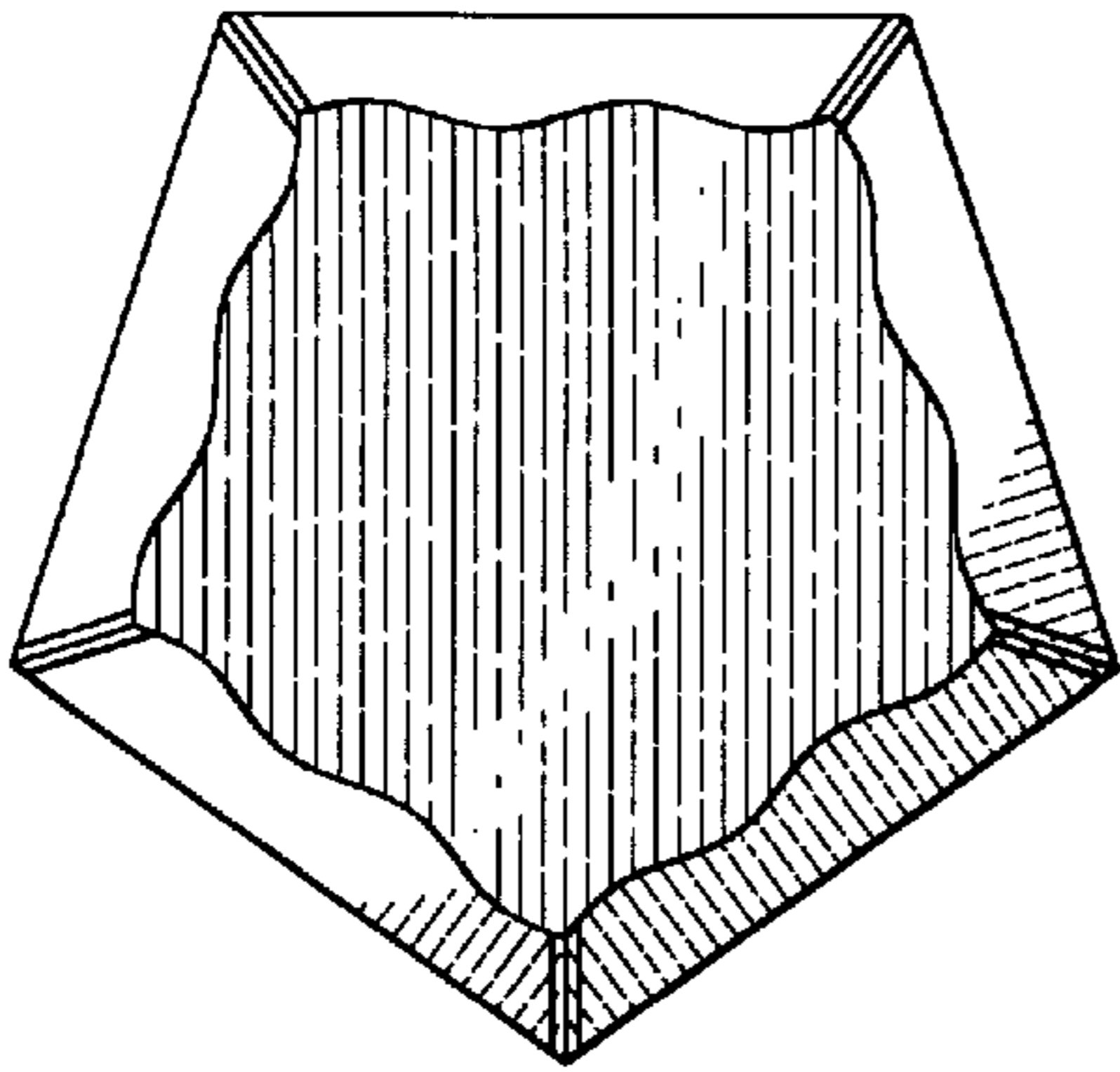

FIG. 31

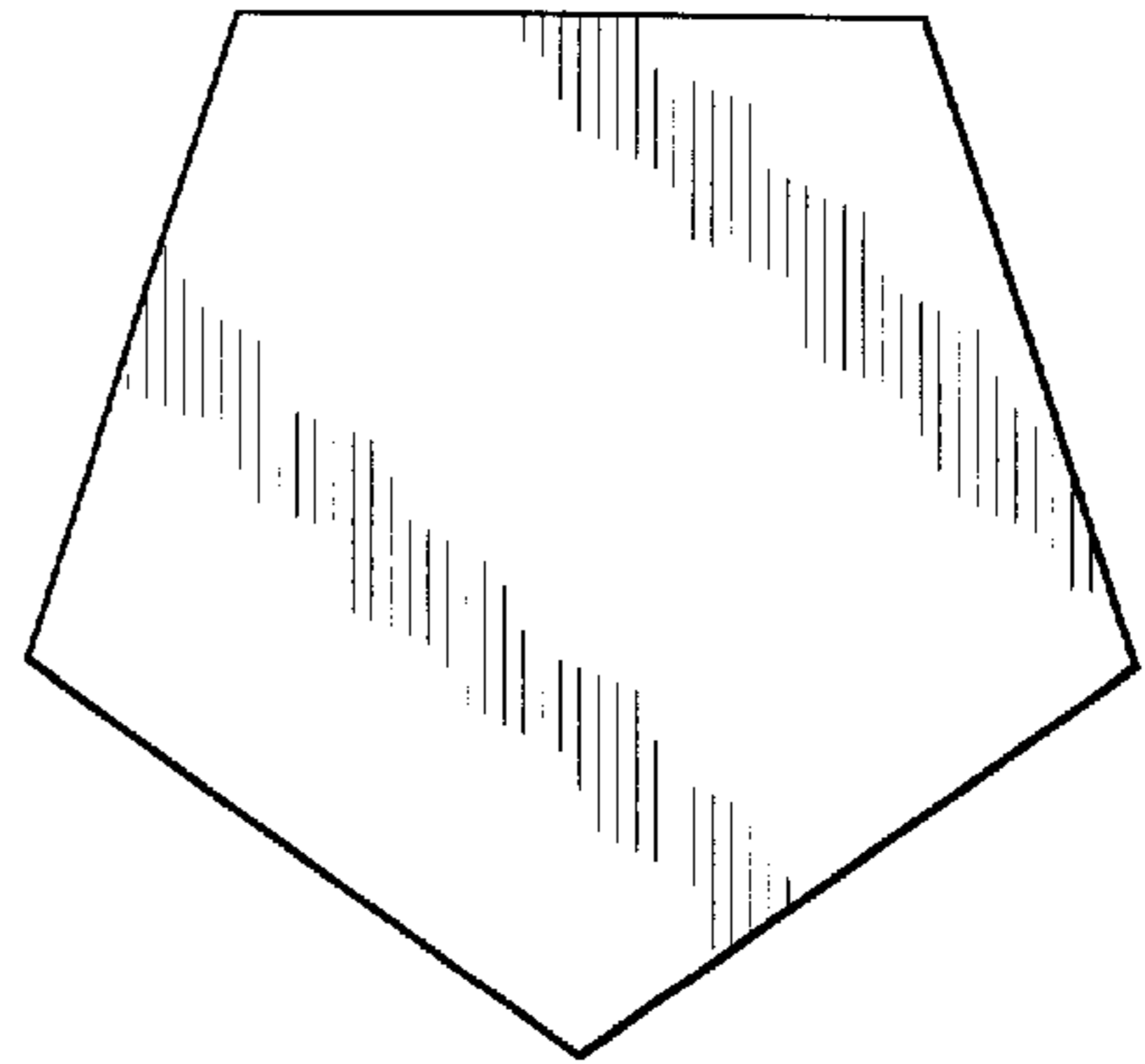

FIG. 32

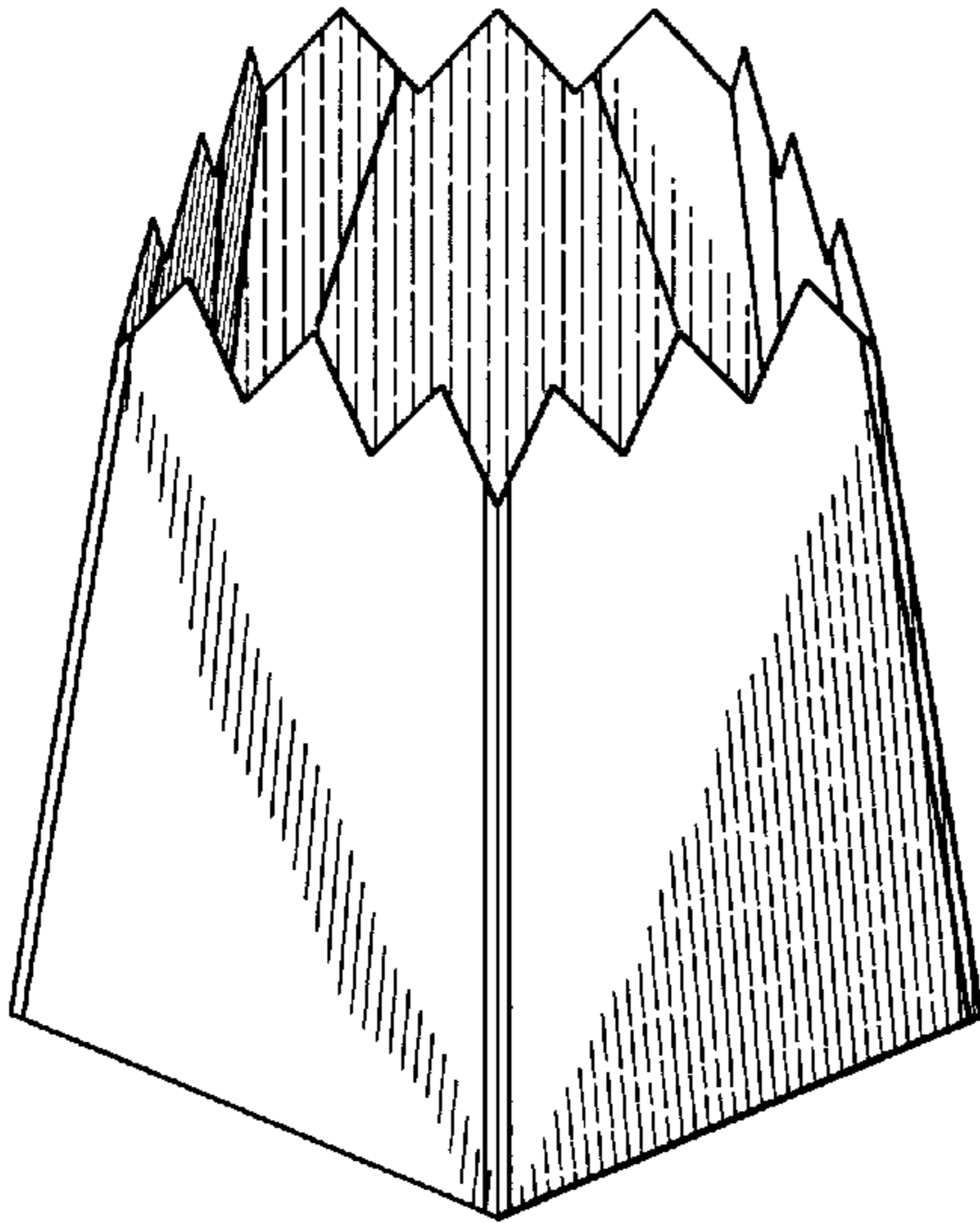

FIG. 33

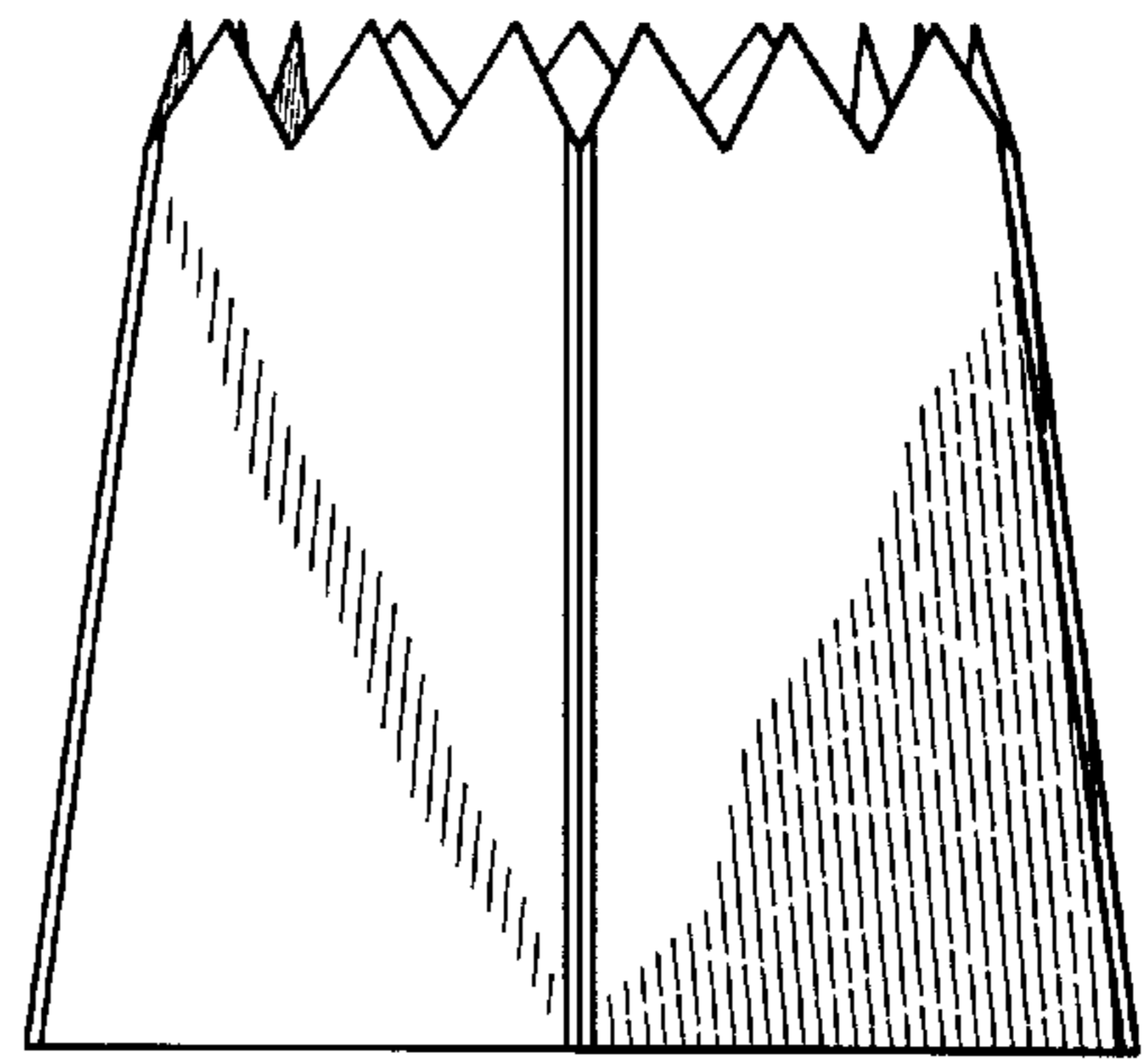

FIG. 34

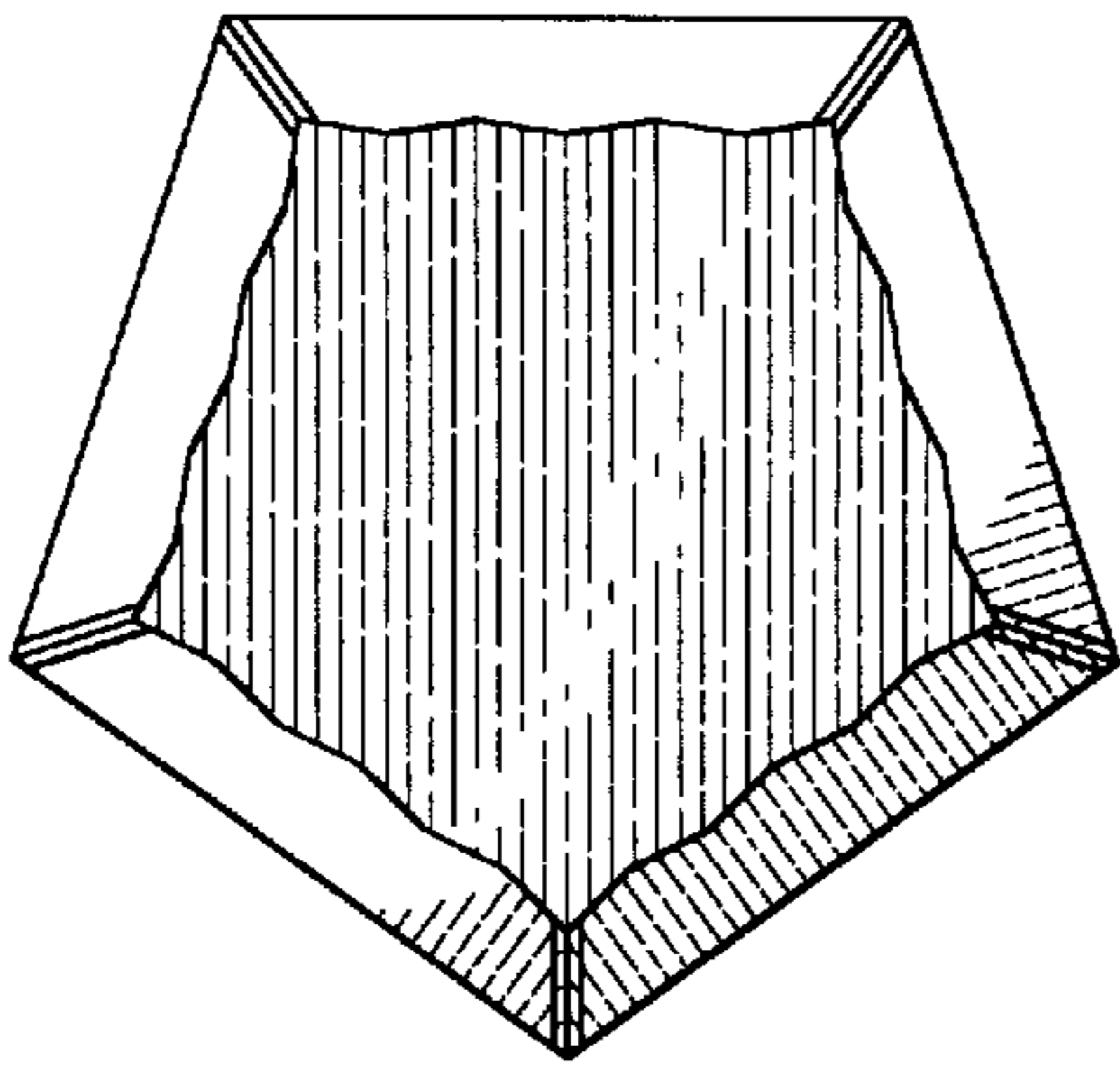

FIG. 35

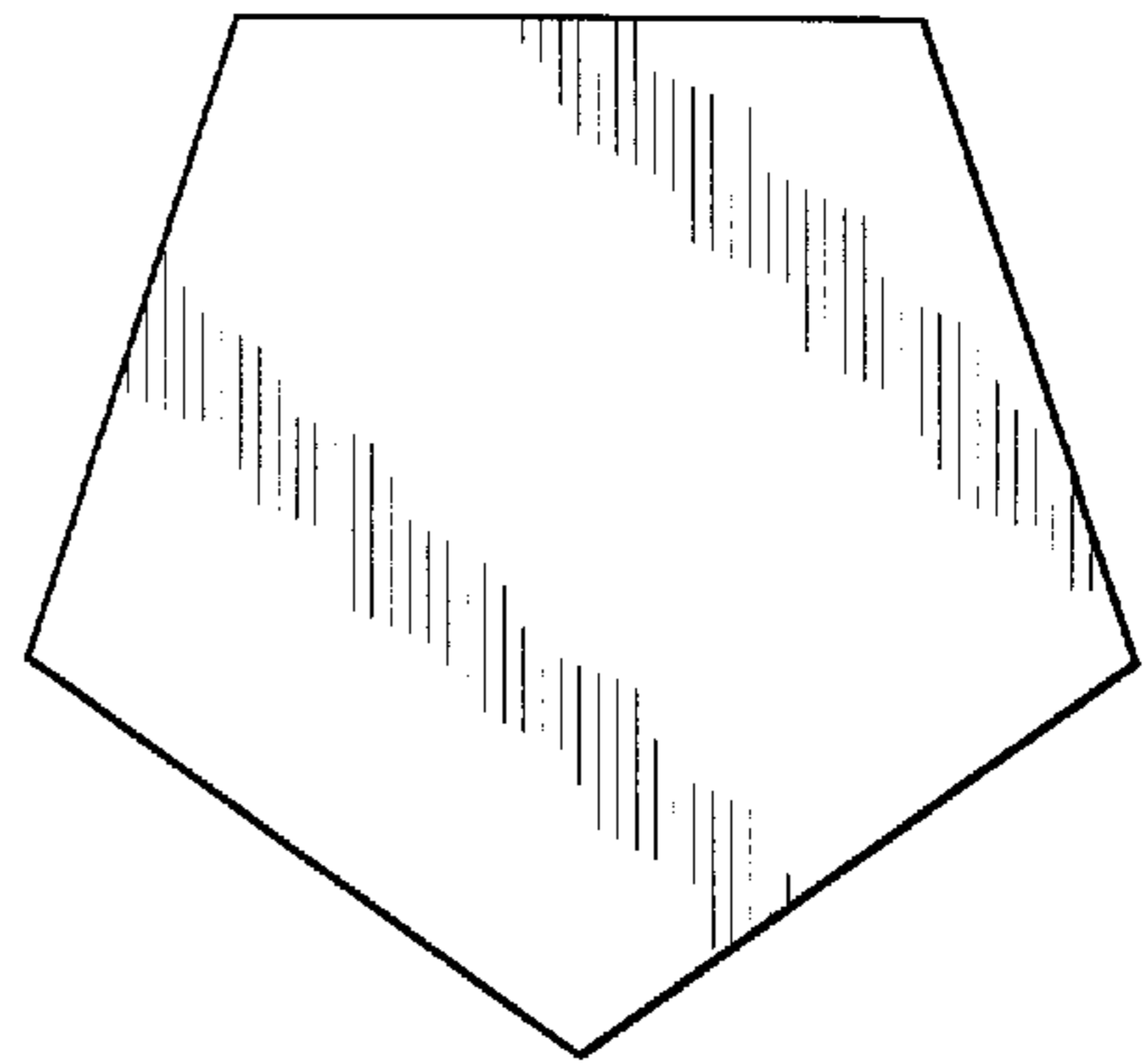

FIG. 36

UNITED STATES PATENT AND TRADEMARK OFFICE
CERTIFICATE OF CORRECTION

PATENT NO. : Des. 403,269
DATED : December 29, 1998
INVENTOR(S) : Donald E. Weder et al.

Page 1 of 2

It is certified that error appears in the above-identified patent and that said Letters Patent is hereby corrected as shown below:
On the title page, Item [62],

under Related U.S. Application Data [62], lines 1-2, please delete "8,387,012", and substitute therefor
--D387,012--.

under Related U.S. Application Data [62], line 3, please delete "8,371,521", and substitute therefor
--D371,521--.

under Related U.S. Application Data [62], line 4, please delete "8,355,395", and substitute therefor
--D355,395--.

under Related U.S. Application Data [62], line 6, please delete "8,365,302", and substitute therefor
--D365,302--.

under Related U.S. Application Data [62], line 8, please delete "8,365,302", and substitute therefor
--D365,302--.

under Related U.S. Application Data [62], line 9, please delete "8,358,113", and substitute therefor
--D358,113--.

UNITED STATES PATENT AND TRADEMARK OFFICE
CERTIFICATE OF CORRECTION

PATENT NO. : Des. 403,269
DATED : December 29, 1998
INVENTOR(S) : Donald E. Weder et al.

Page 2 of 2

It is certified that error appears in the above-identified patent and that said Letters Patent is hereby corrected as shown below:

under Related U.S. Application Data [62], line 10, please delete "8,365,302", and substitute therefor --D365,302--.

under Related U.S. Application Data [62], line 13, please delete "8,365,302", and substitute therefor --D365,302--.

Signed and Sealed this
Twenty-ninth Day of June, 1999

Attest:



Q. TODD DICKINSON

Attesting Officer

Acting Commissioner of Patents and Trademarks