



US00D403210S

United States Patent [19]
Licari

[11] **Patent Number: Des. 403,210**

[45] **Date of Patent: **Dec. 29, 1998**

[54] **COLANDER**

[76] Inventor: **Yaffa Licari**, 875 Ocean Ave., Elberon,
N.J. 07740

[**] Term: **14 Years**

[21] Appl. No.: **44,637**

[22] Filed: **Sep. 27, 1995**

[51] **LOC (6) Cl.** **07-04**

[52] **U.S. Cl.** **D7/667**

[58] **Field of Search** D7/356, 400, 667,
D7/668; 99/403, 426; 210/464, 465, 470,
473, 498, 499

[56] **References Cited**

U.S. PATENT DOCUMENTS

D. 314,315 2/1991 Darnell D7/667
D. 339,506 9/1993 Feer D7/667

Primary Examiner—Terry A. Wallace
Attorney, Agent, or Firm—Morton Chirnomas

[57] **CLAIM**

The ornamental design for a colander, as shown and described.

DESCRIPTION

FIG. 1 is a top, front, left side perspective view of a colander showing my new design;
FIG. 2 is a top plan view thereof;
FIG. 3 is a bottom plan view thereof;
FIG. 4 is a front elevation view thereof;
FIG. 5 is a left side elevation view thereof;
FIG. 6 is a right side elevation view thereof;
FIG. 7 is a rear elevation view thereof;
FIG. 8 is a top, front, left side perspective view of an alternate embodiment of FIG. 1;
FIG. 9 is a top plan view of FIG. 8;
FIG. 10 is a bottom plan view of FIG. 8;
FIG. 11 is a front elevation view of FIG. 8;
FIG. 12 is left side elevation view of FIG. 8;
FIG. 13 is a right side elevation view of FIG. 8; and,
FIG. 14 is a rear elevation view of FIG. 8.

1 Claim, 9 Drawing Sheets

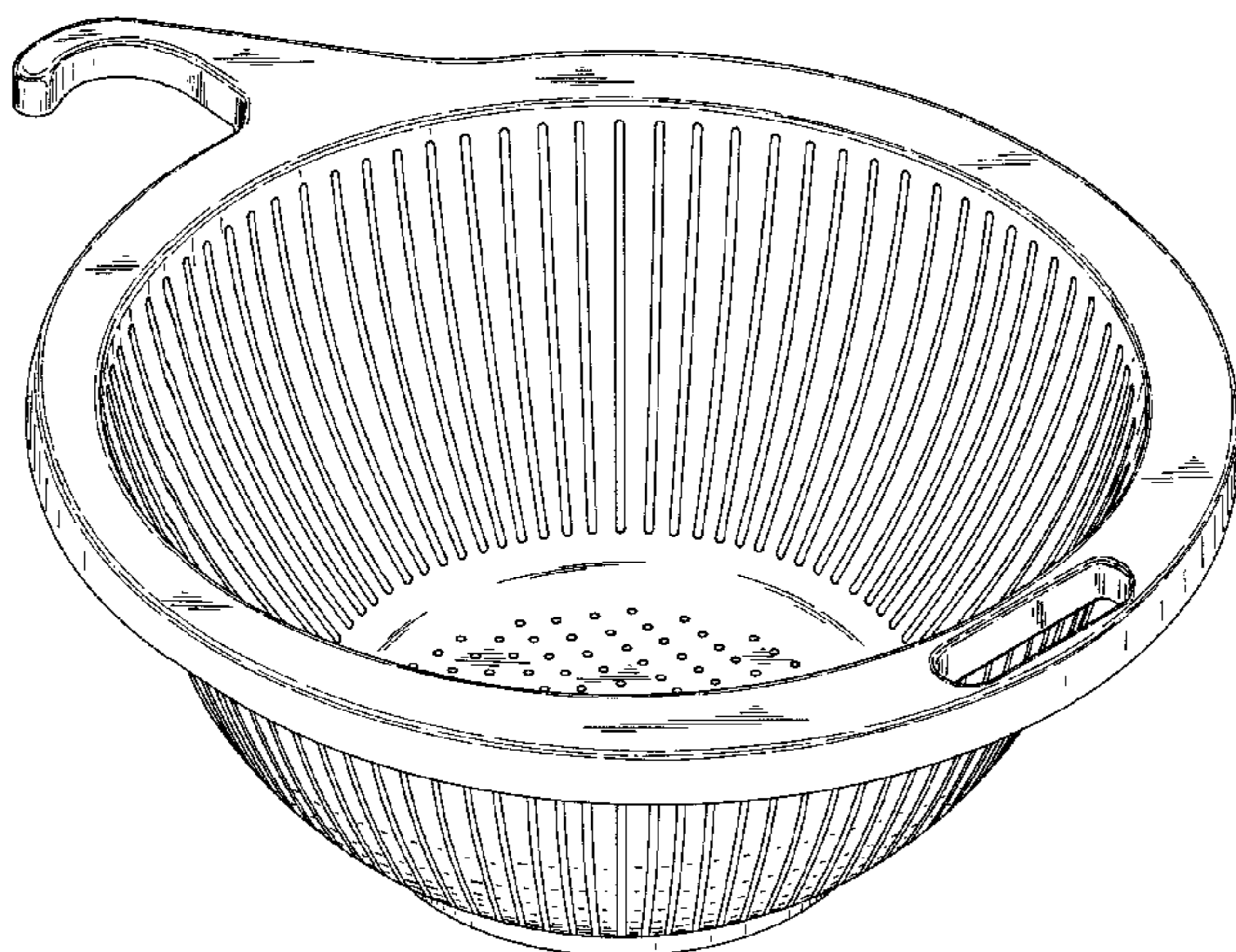
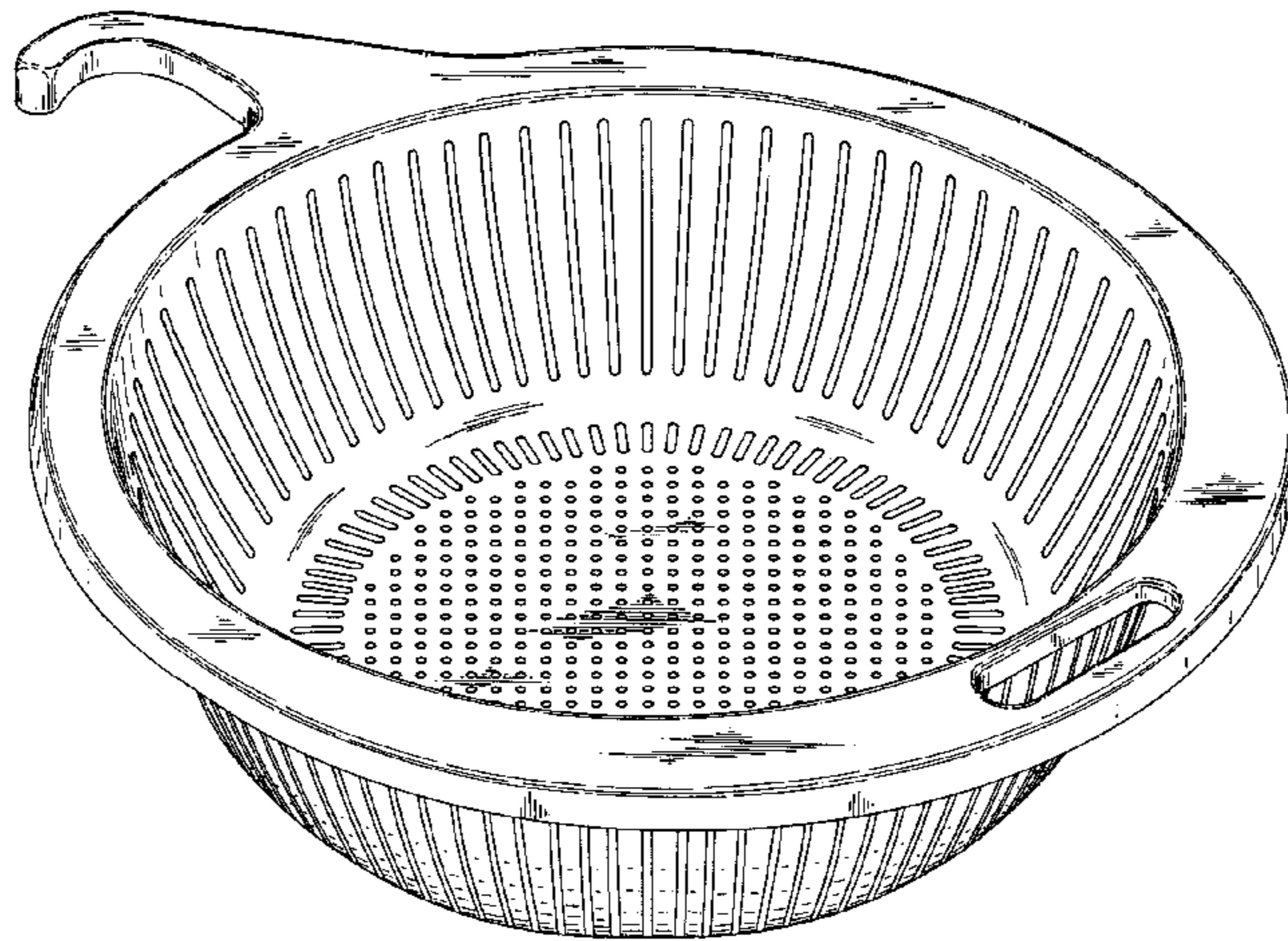

FIG. 1

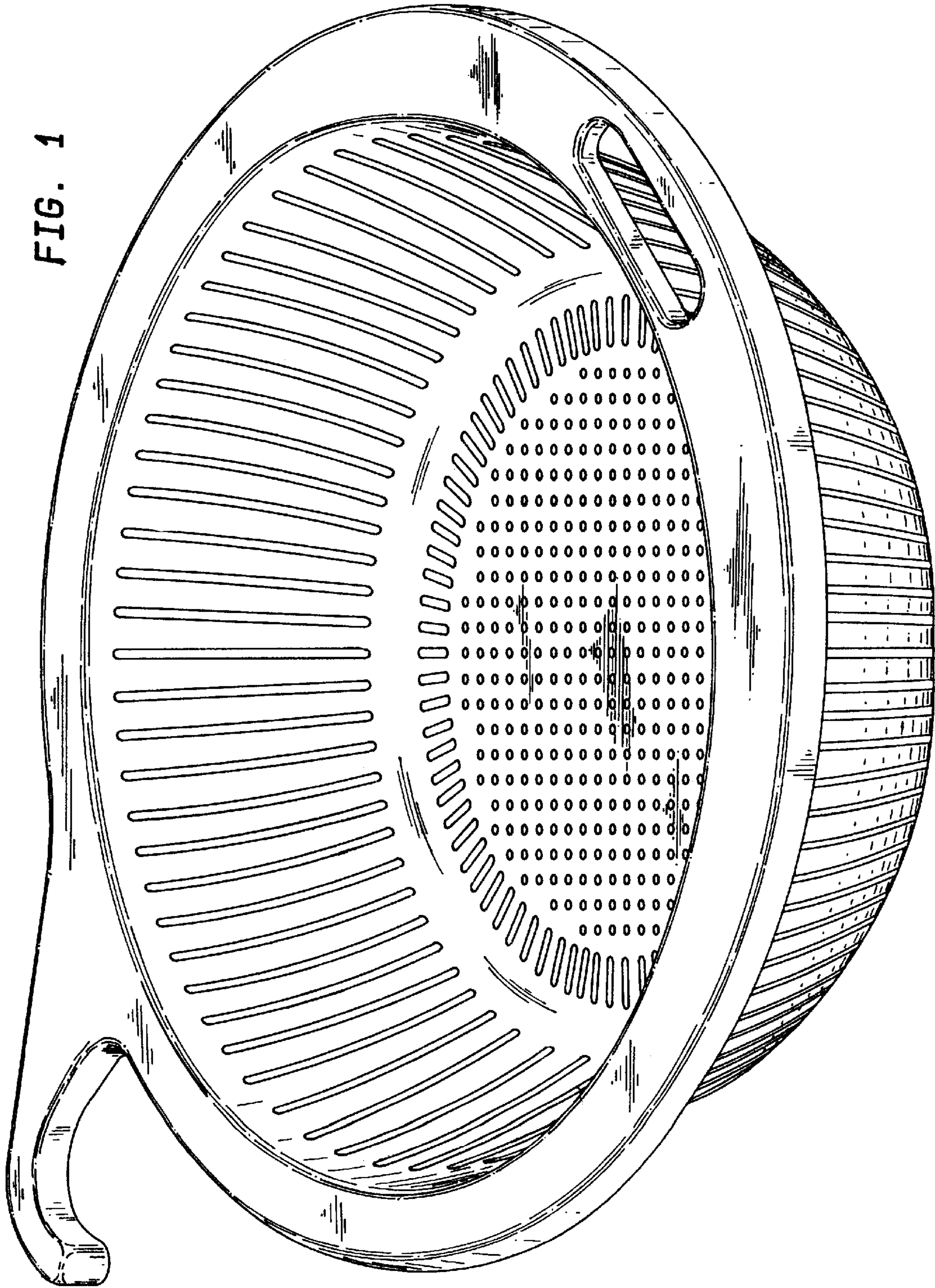

FIG. 2

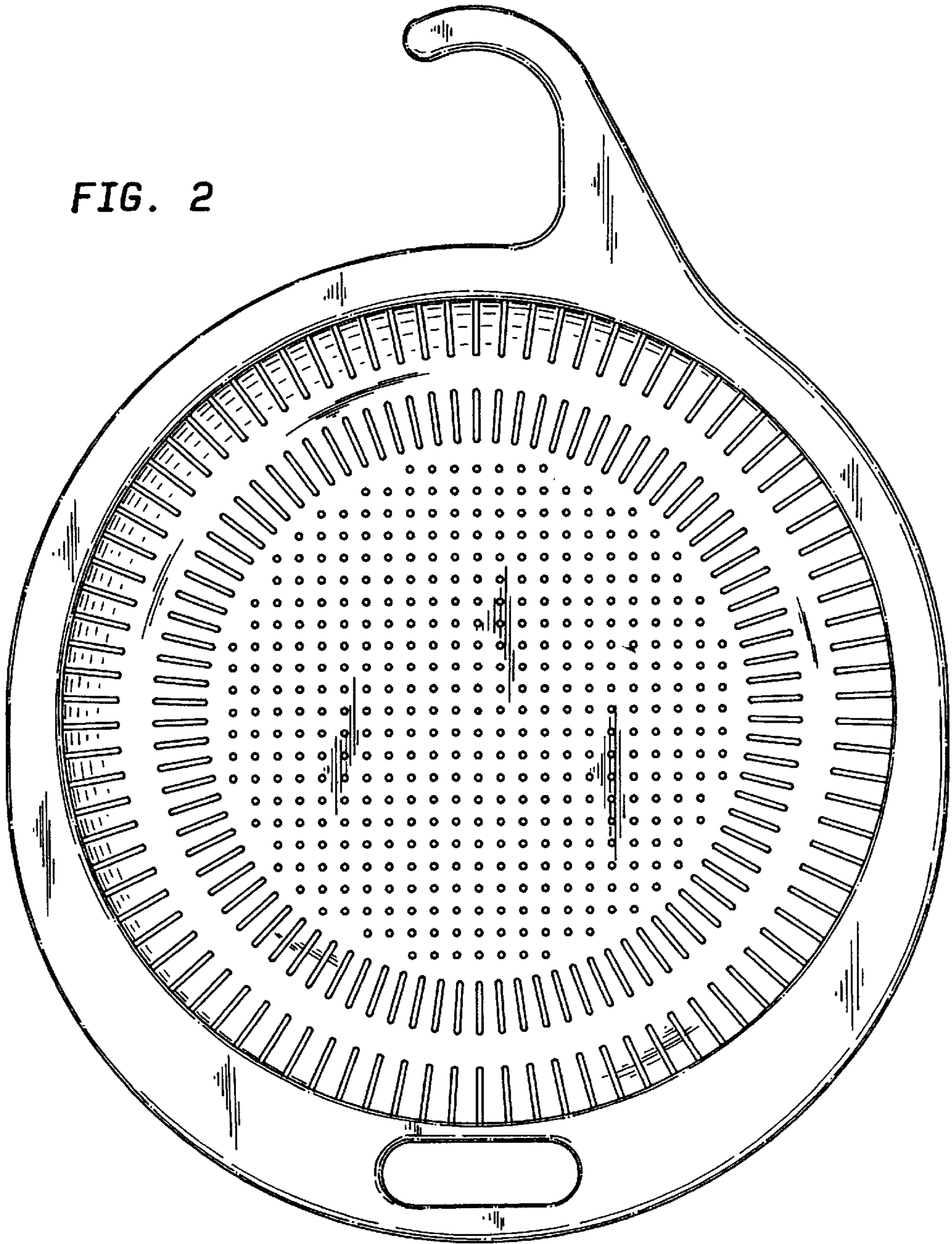
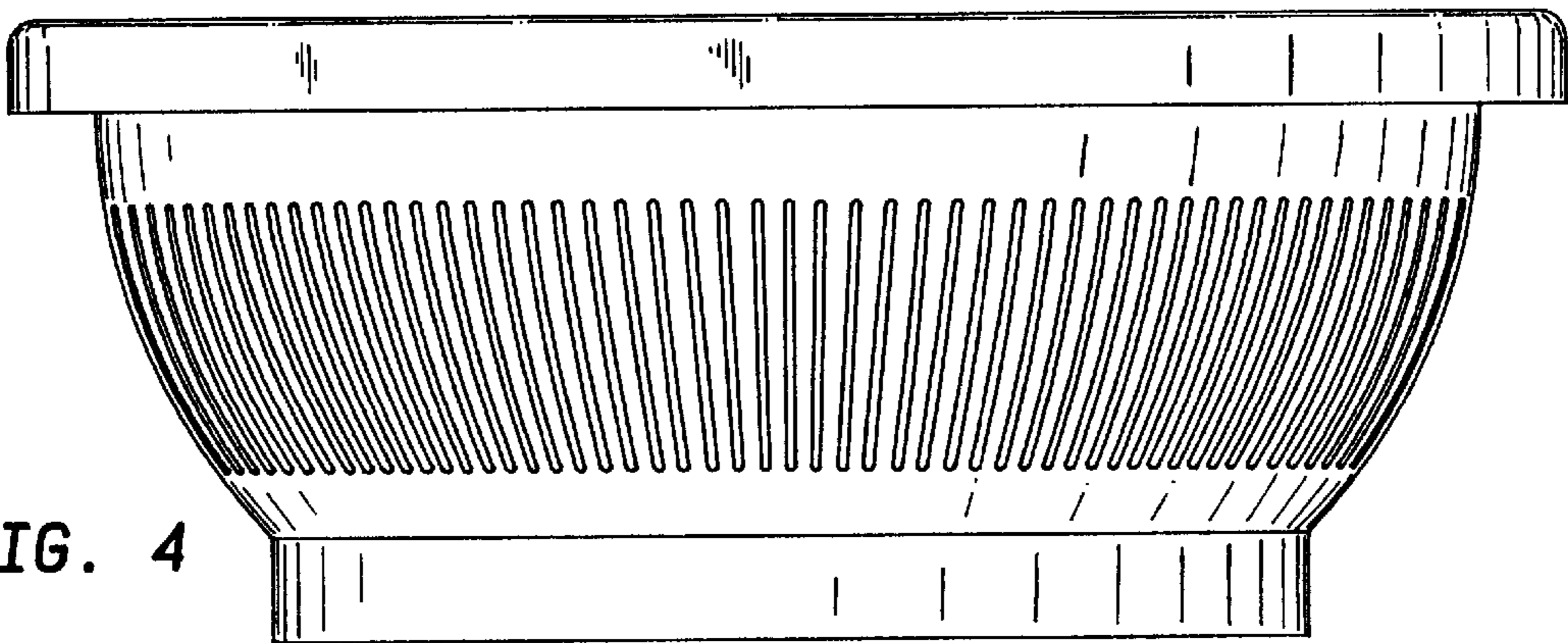

FIG. 4



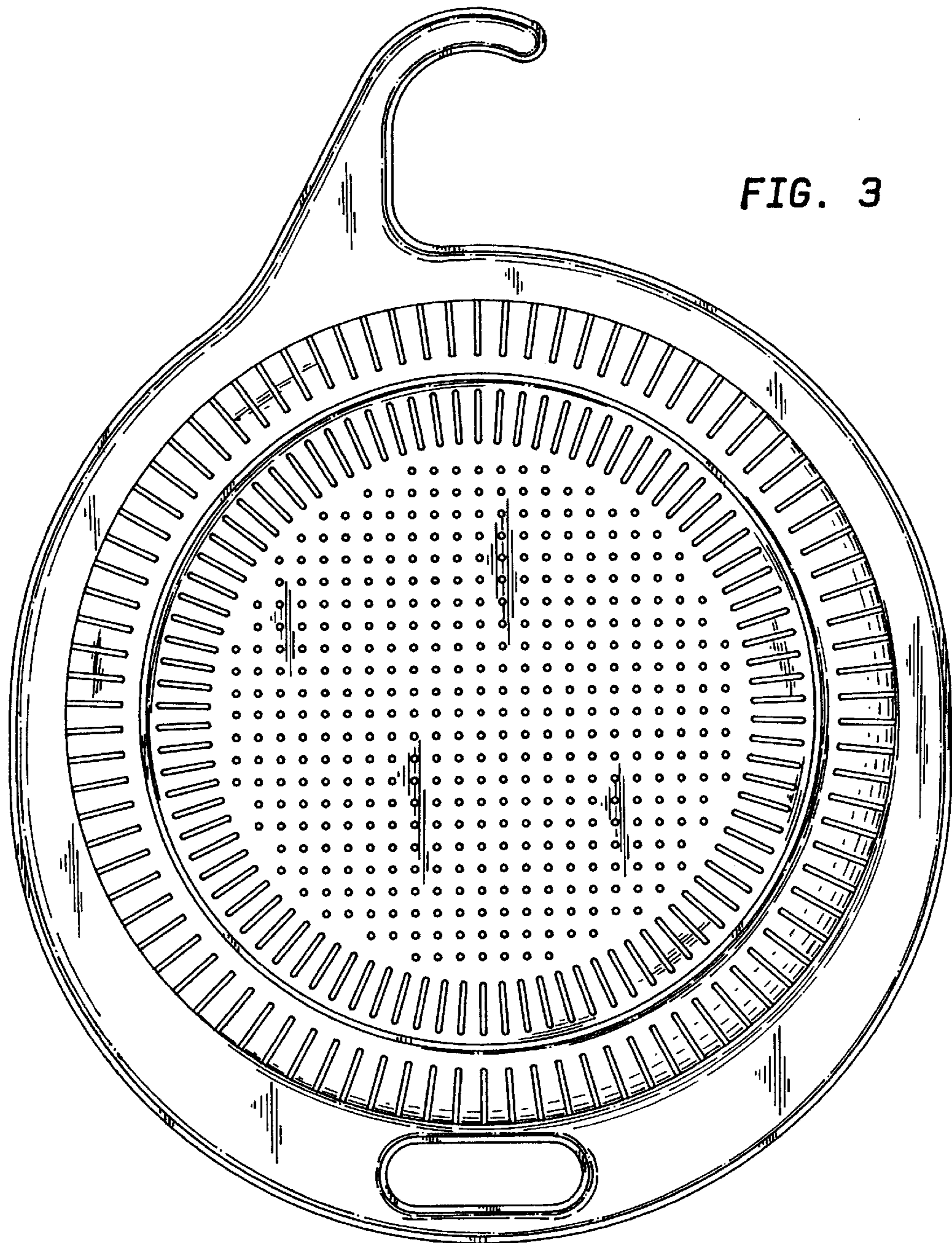

FIG. 3

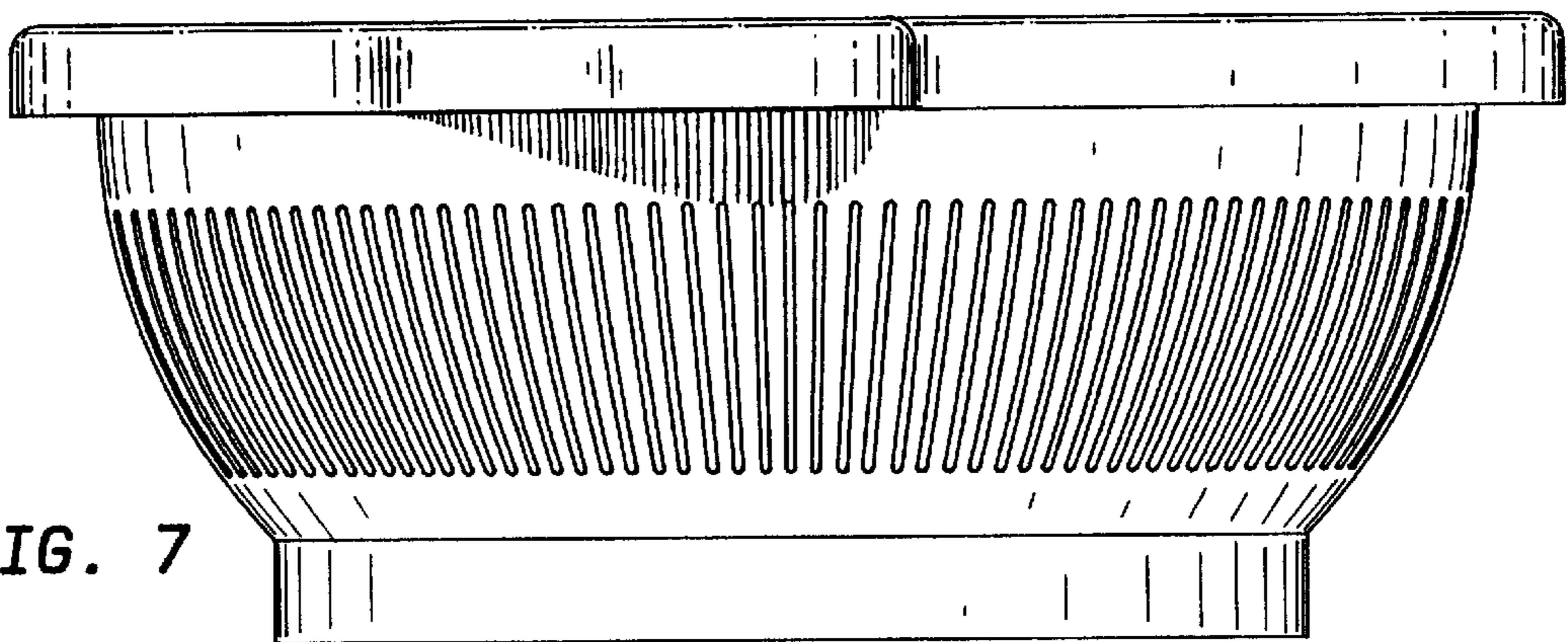

FIG. 7

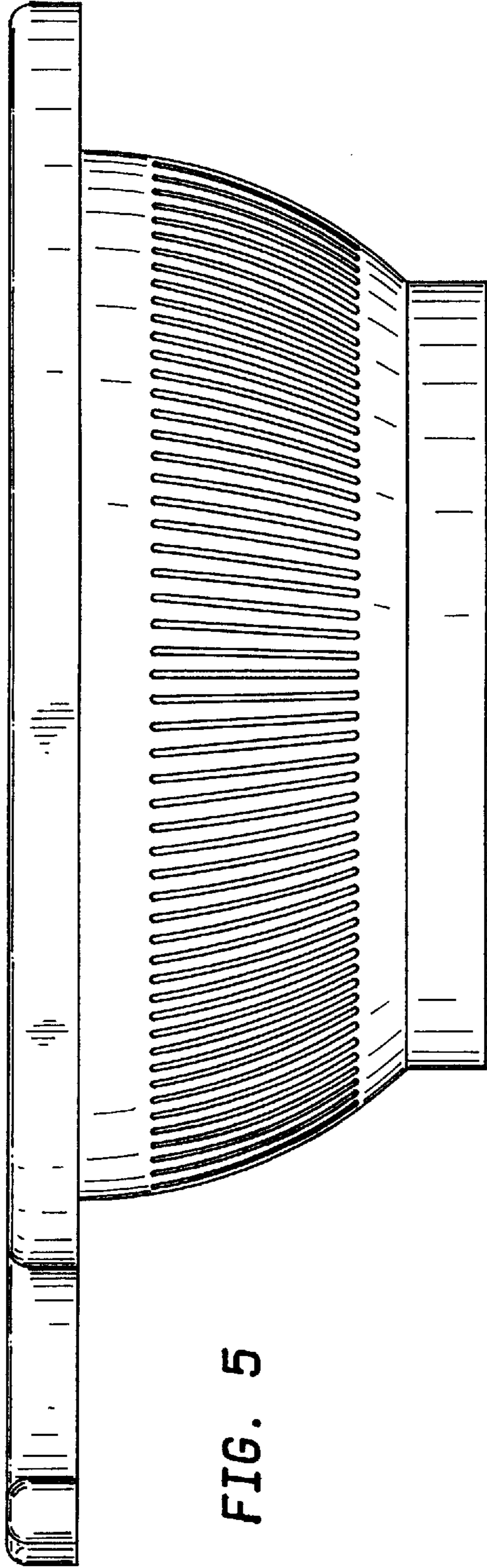

FIG. 5

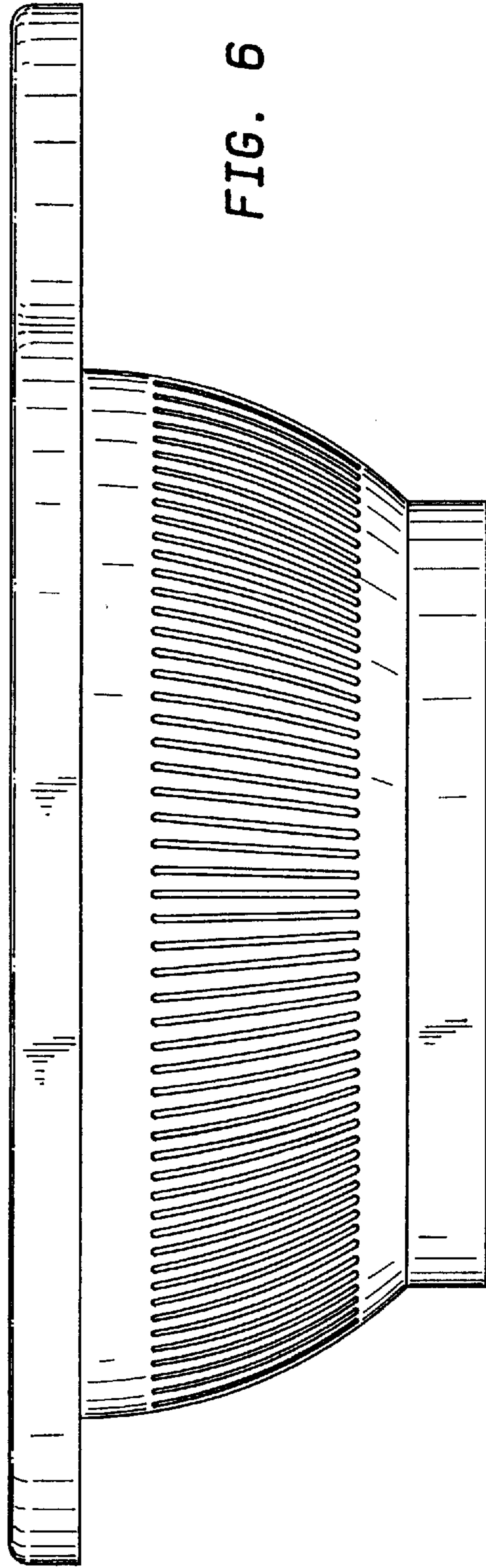

FIG. 6

FIG. 8

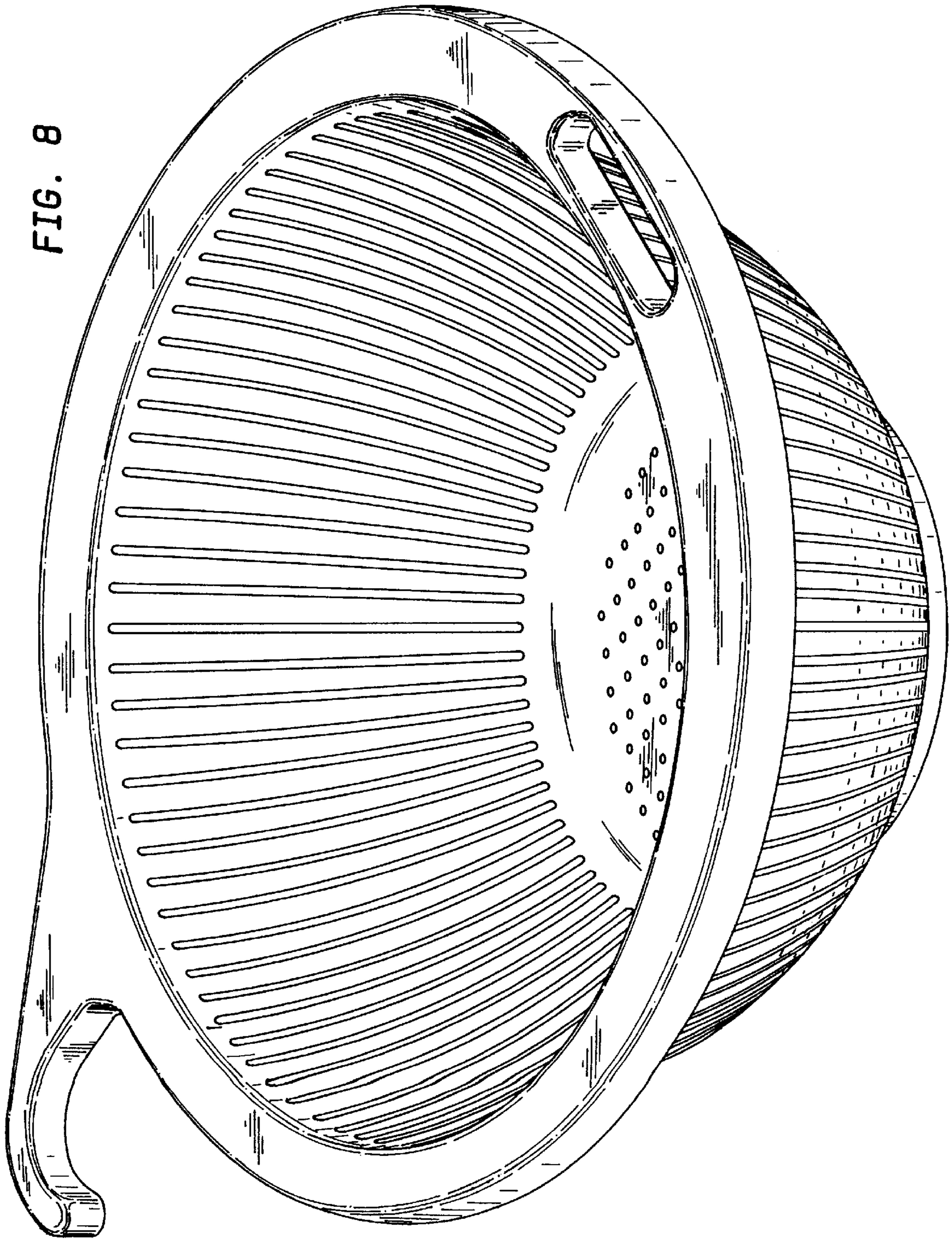

FIG. 9

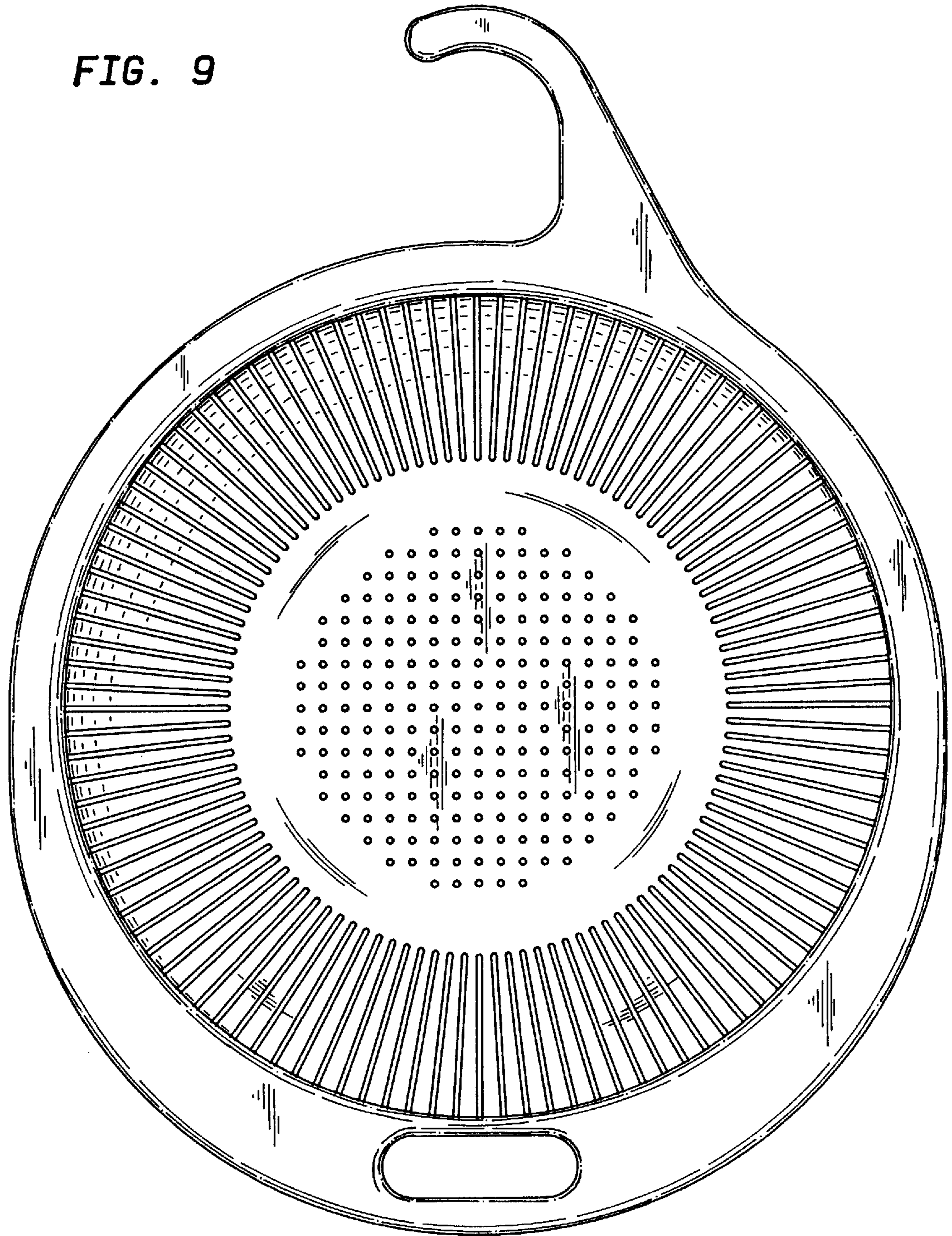

FIG. 10

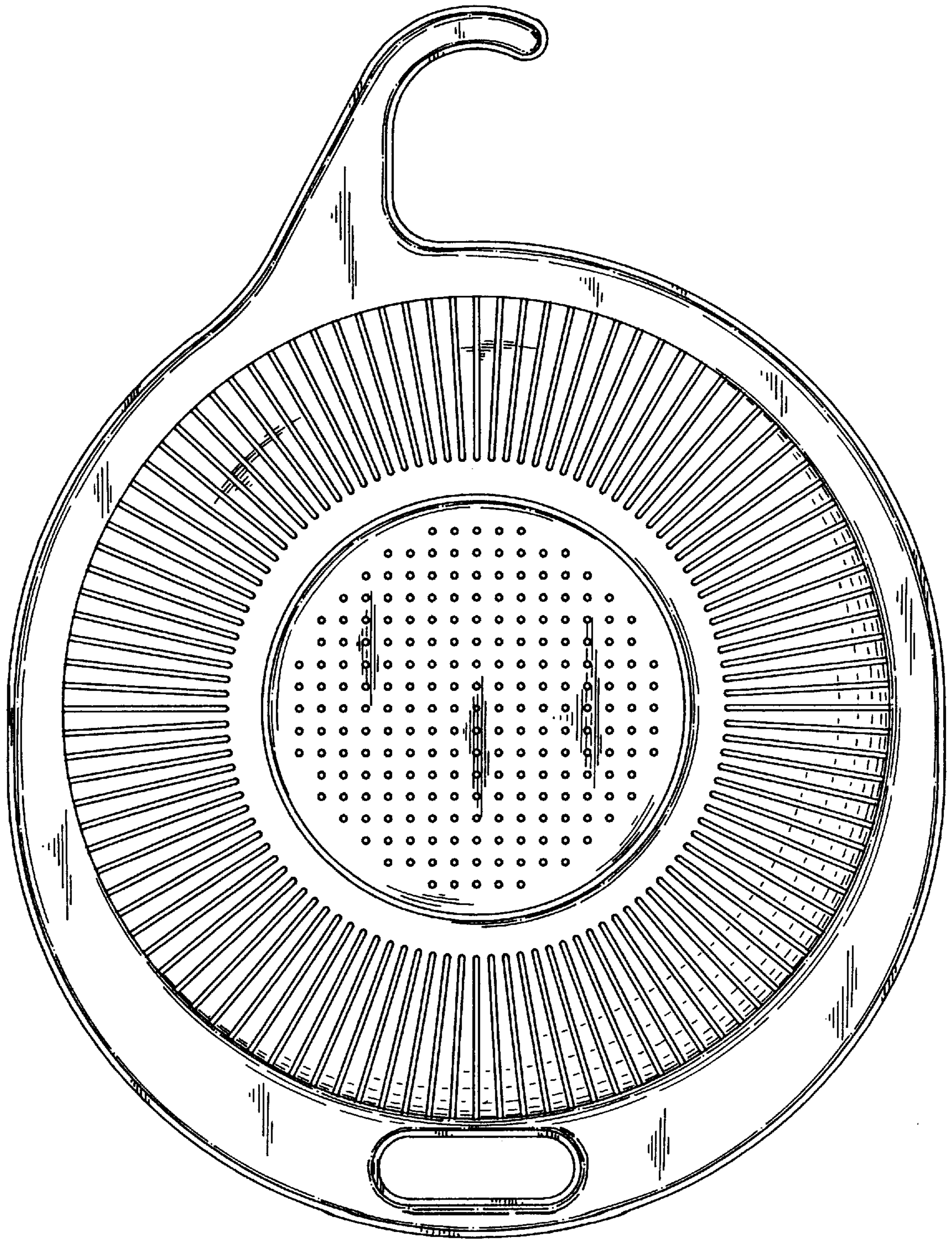

FIG. 11

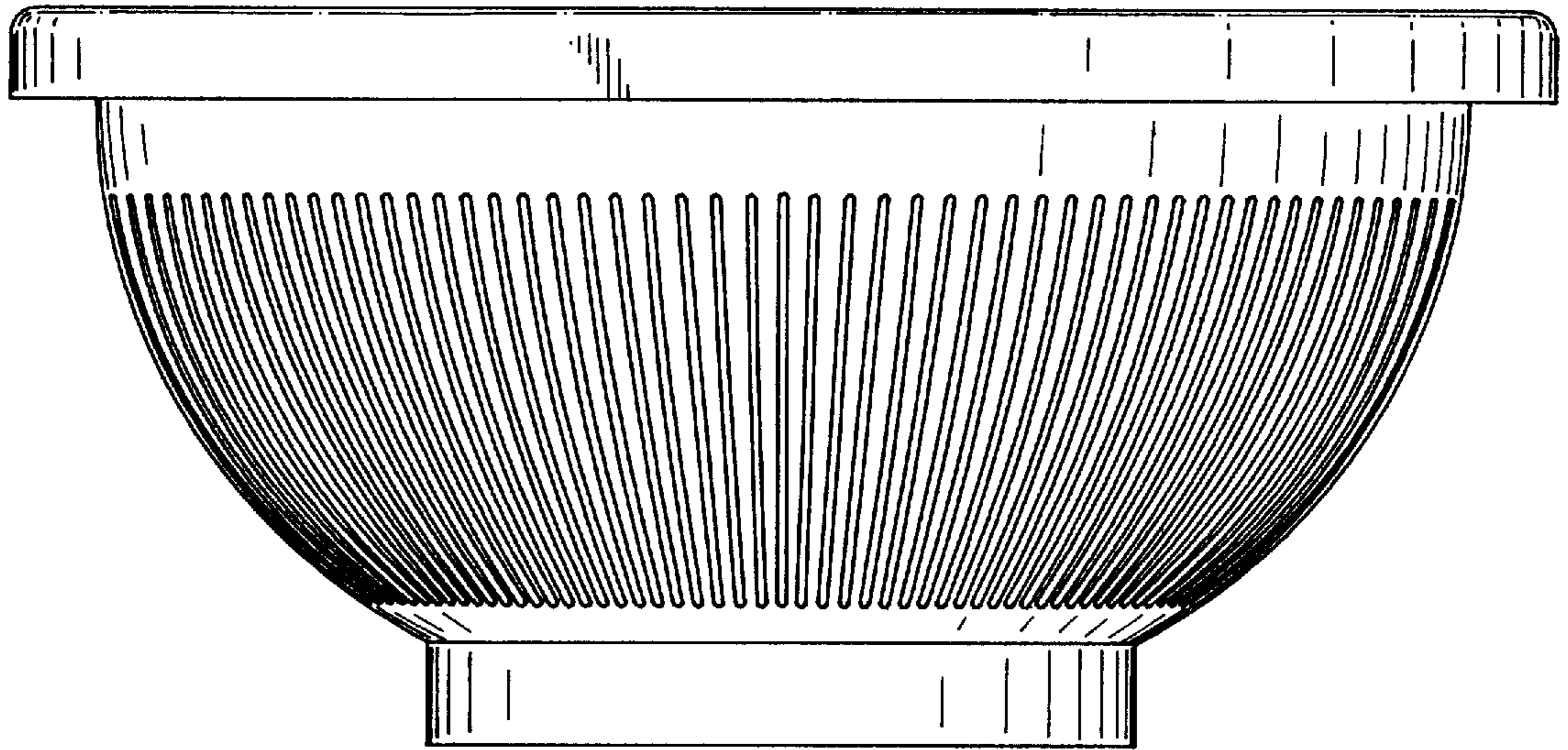
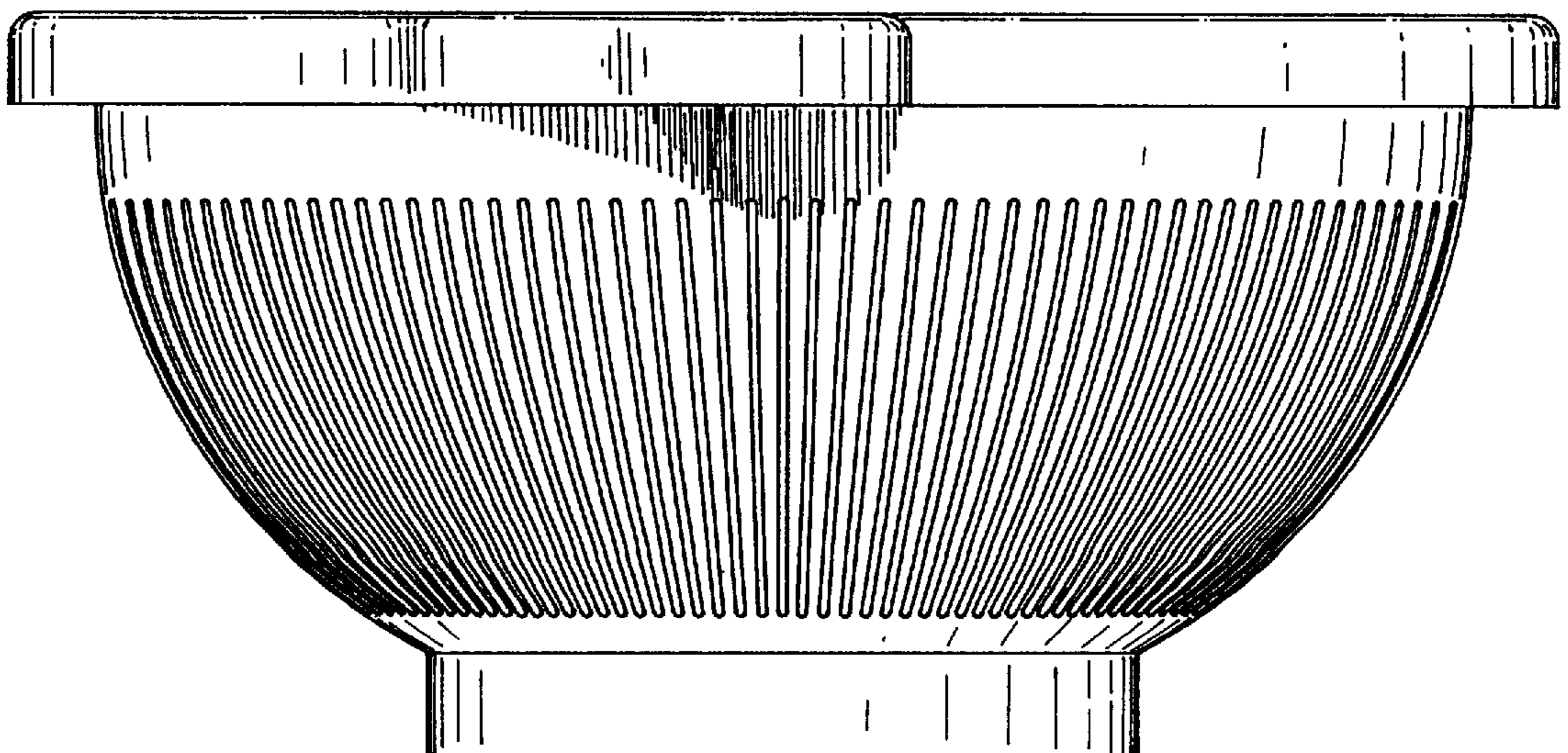

FIG. 14



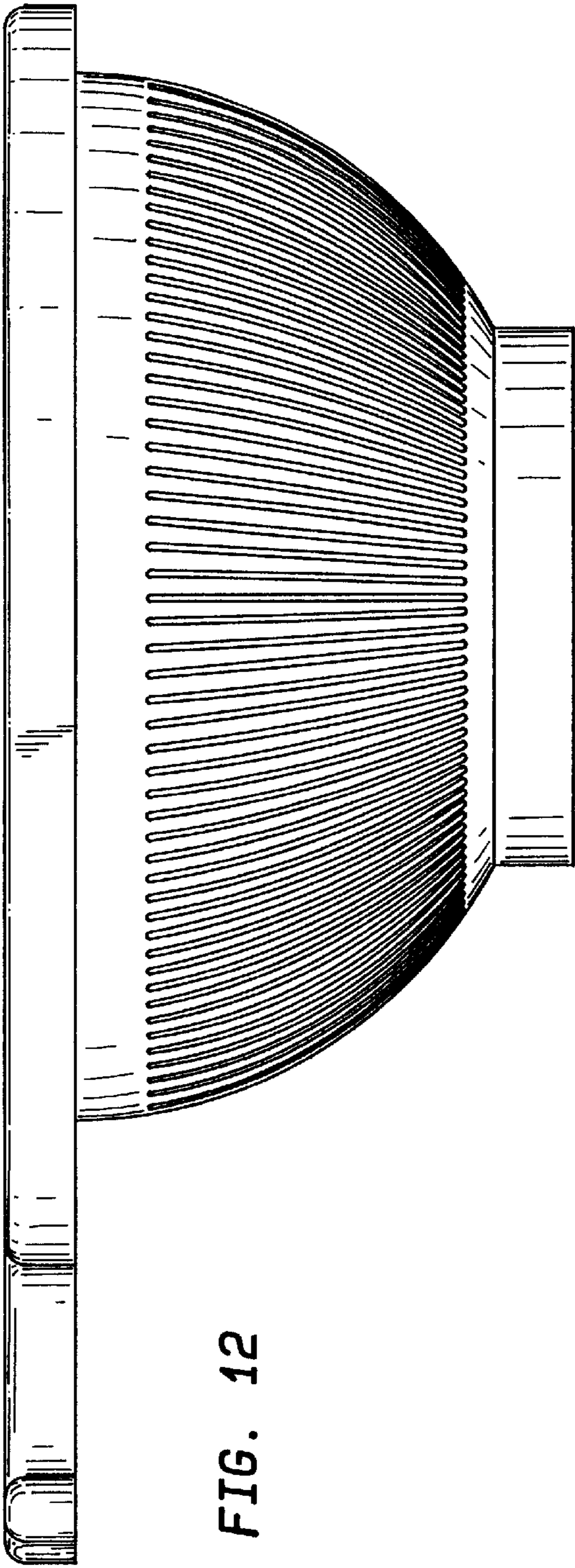

FIG. 12

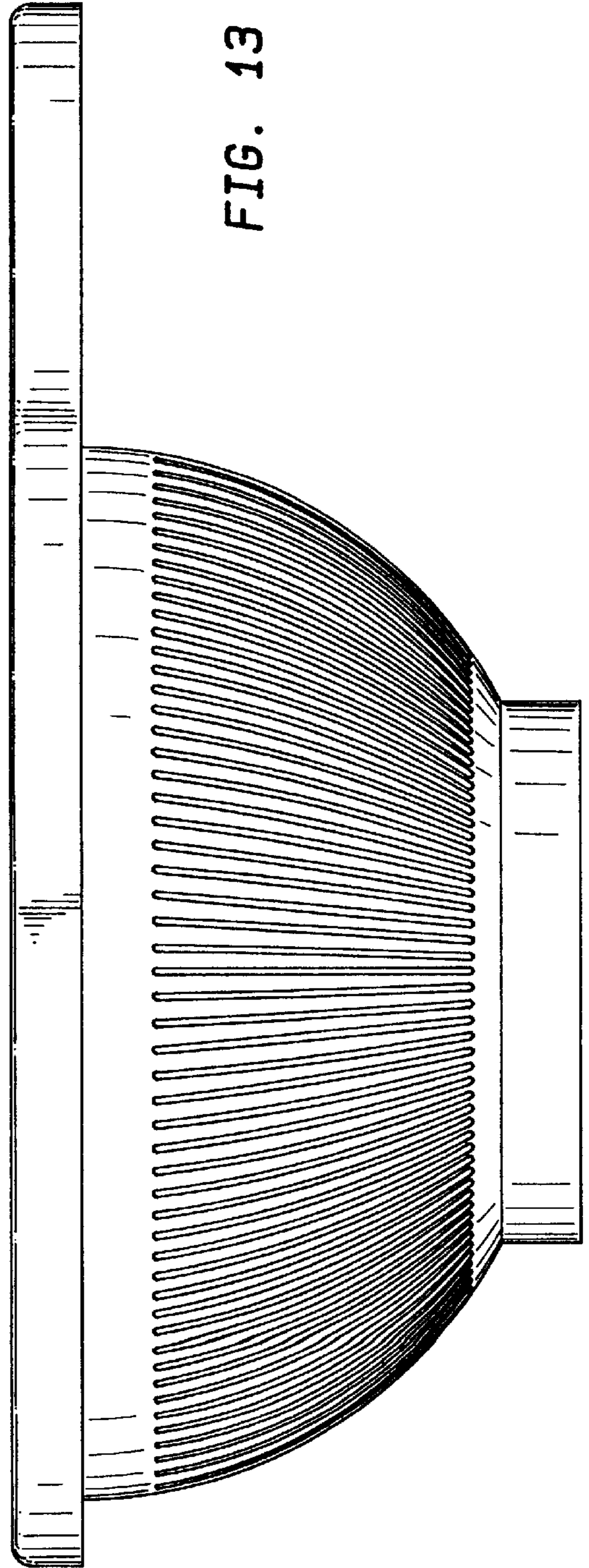

FIG. 13