



US00D403102S

**United States Patent** [19]  
**Archambault**

[11] **Patent Number: Des. 403,102**

[45] **Date of Patent: \*\*Dec. 22, 1998**

[54] **LIGHT DIFFUSER**

D. 204,988 6/1966 Burnbaum ..... D26/125 X  
3,940,521 2/1976 Hack ..... 362/806 X  
4,930,053 5/1990 Vaught ..... 362/807 X

[75] Inventor: **Alan Alfred Archambault**, Smithfield,  
R.I.

*Primary Examiner*—Susan J. Lucas  
*Attorney, Agent, or Firm*—Fay, Sharpe, Beall, Fagan,  
Minnich & McKee

[73] Assignee: **General Electric Company**,  
Schenectady, N.Y.

[\*\*] Term: **14 Years**

[57] **CLAIM**

[21] Appl. No.: **76,034**

The ornamental design for a light diffuser, as shown and described.

[22] Filed: **Aug. 27, 1997**

**DESCRIPTION**

[51] **LOC (6) Cl.** ..... **26-05**

FIG. 1 is a perspective view of a light diffuser showing my new design;

[52] **U.S. Cl.** ..... **D26/125; D11/125**

FIG. 2 is a front elevational view thereof, the rear being a mirror image;

[58] **Field of Search** ..... D26/125, 126,  
D26/118, 128-136; 362/341, 343, 345,  
346, 349, 351, 355, 356, 806, 807, 808

FIG. 3 is a top plan view thereof;

FIG. 4 is a left side elevational view thereof;

FIG. 5 is a right side elevational view thereof; and,

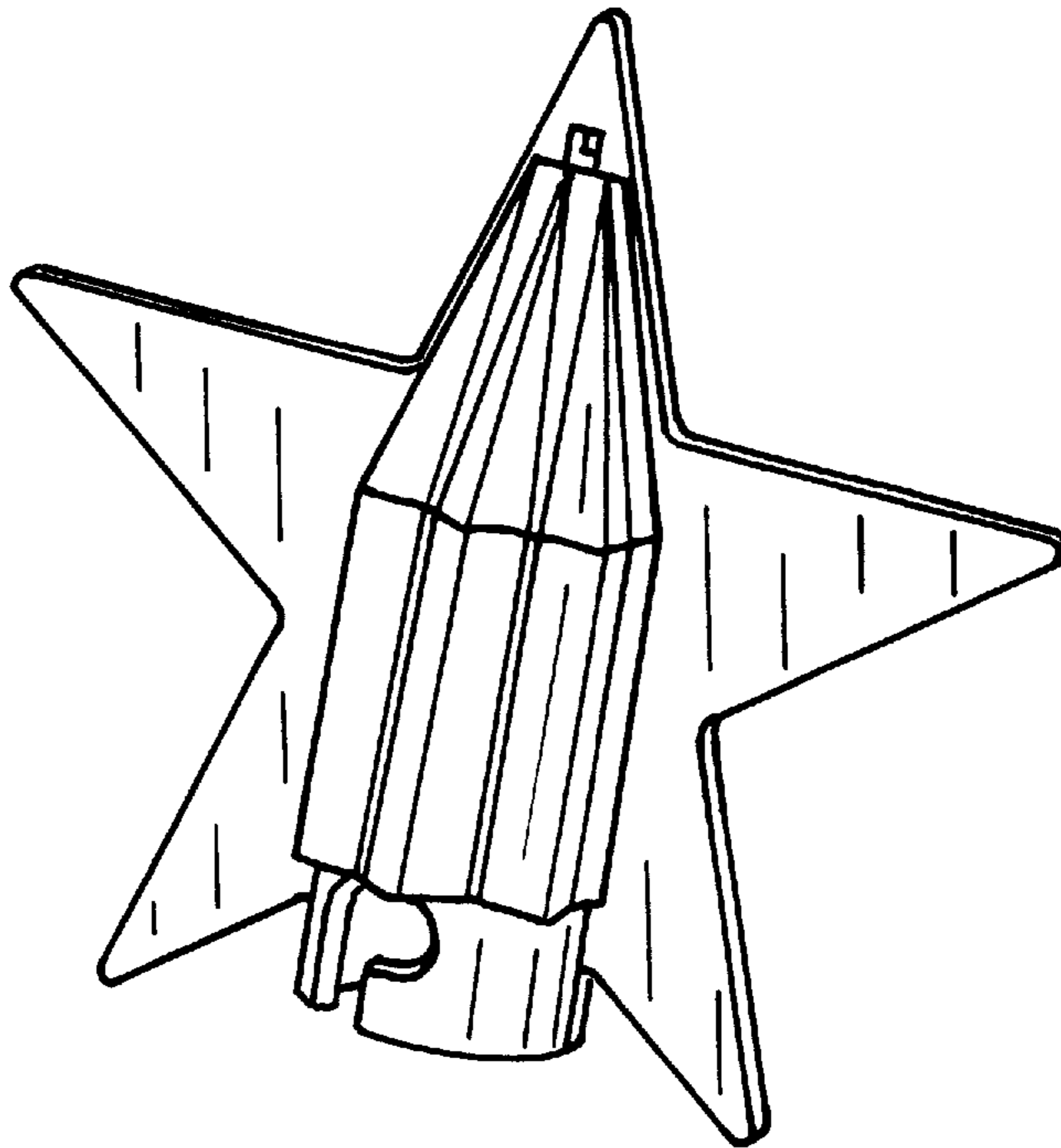
FIG. 6 is a bottom view thereof.

[56] **References Cited**

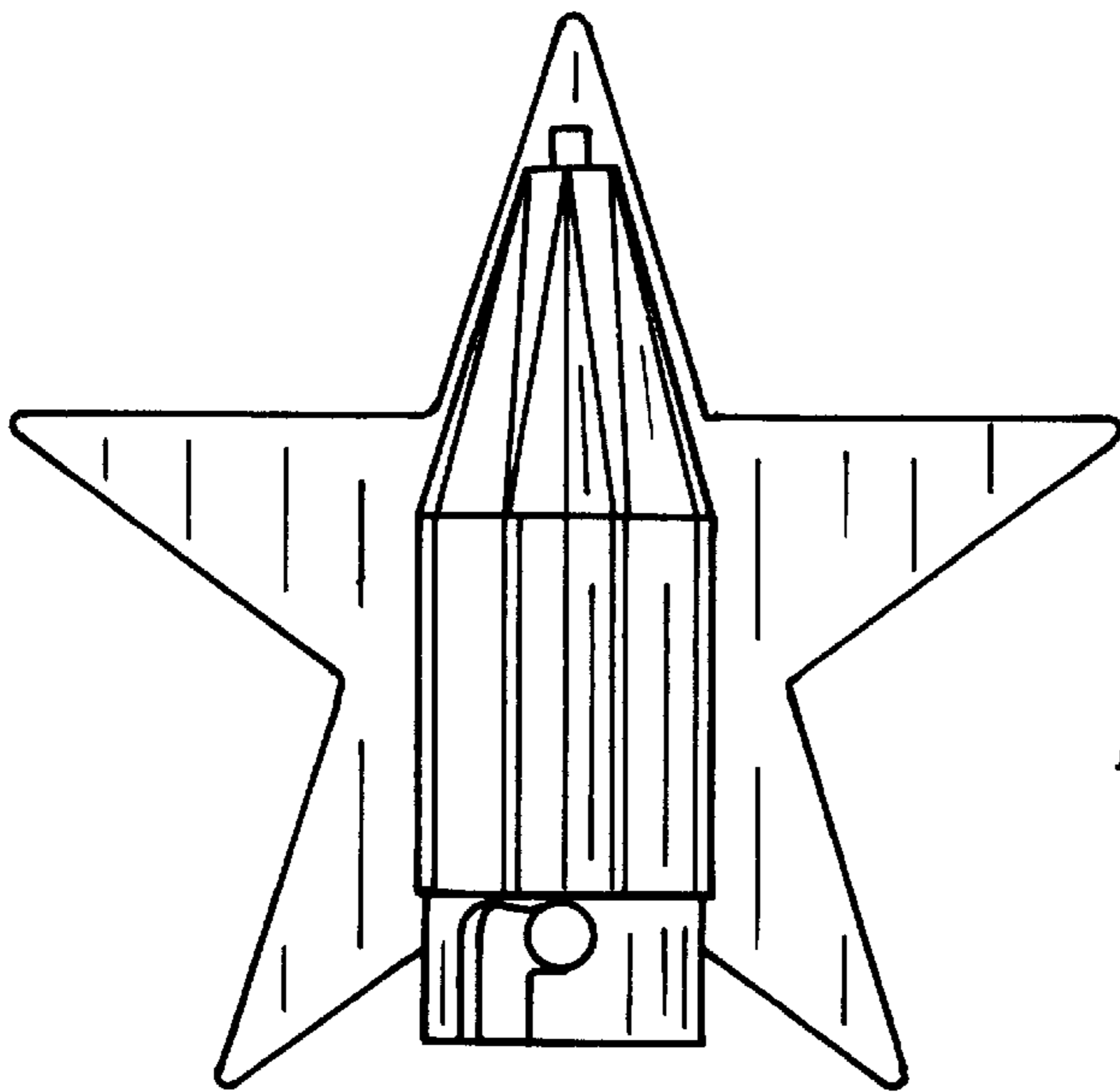
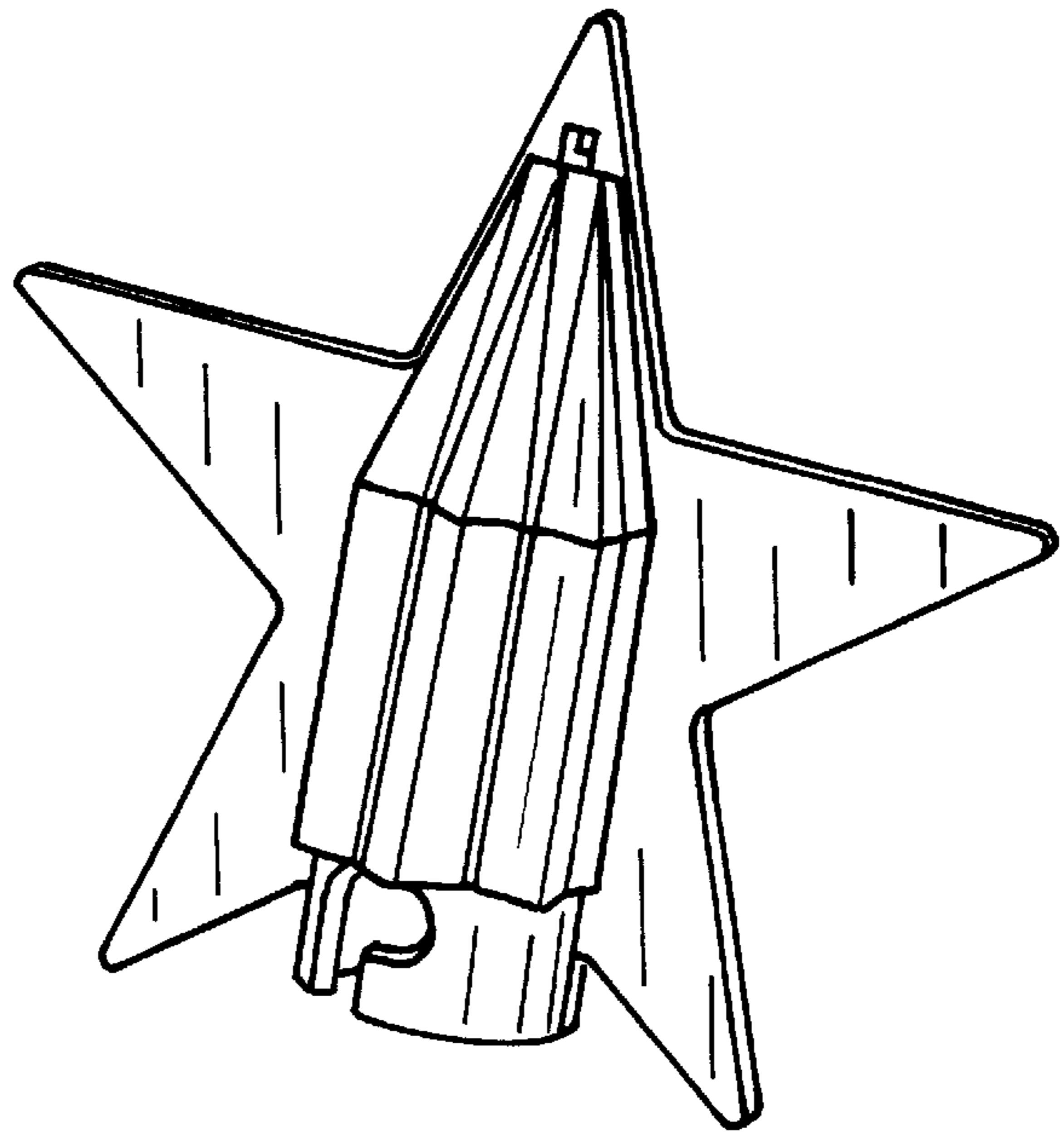
**U.S. PATENT DOCUMENTS**

D. 121,522 7/1940 Petry ..... D26/125 X

**1 Claim, 2 Drawing Sheets**

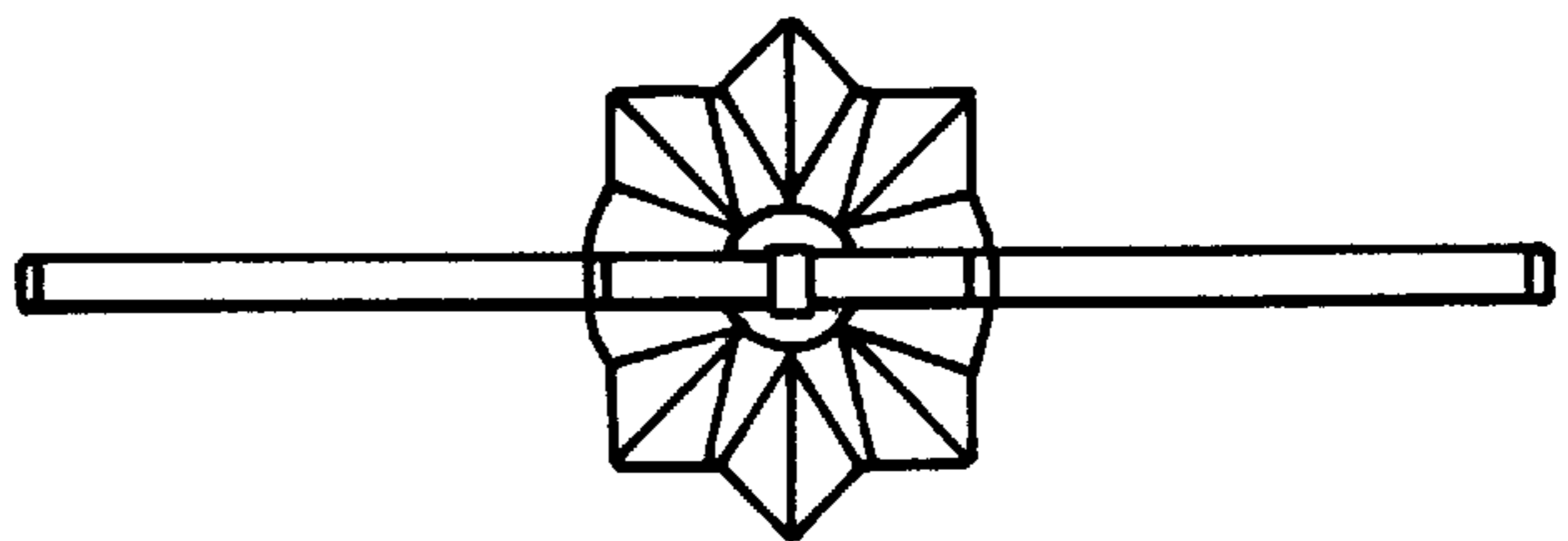


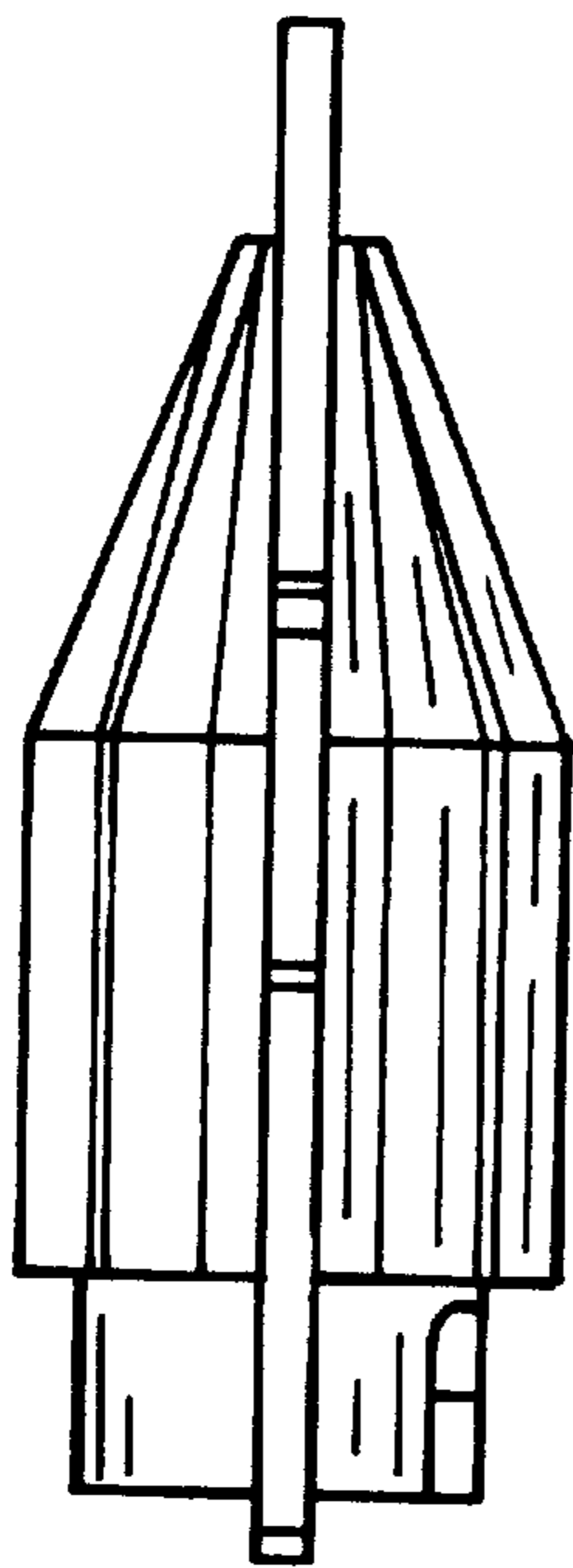
*Fig. 1*



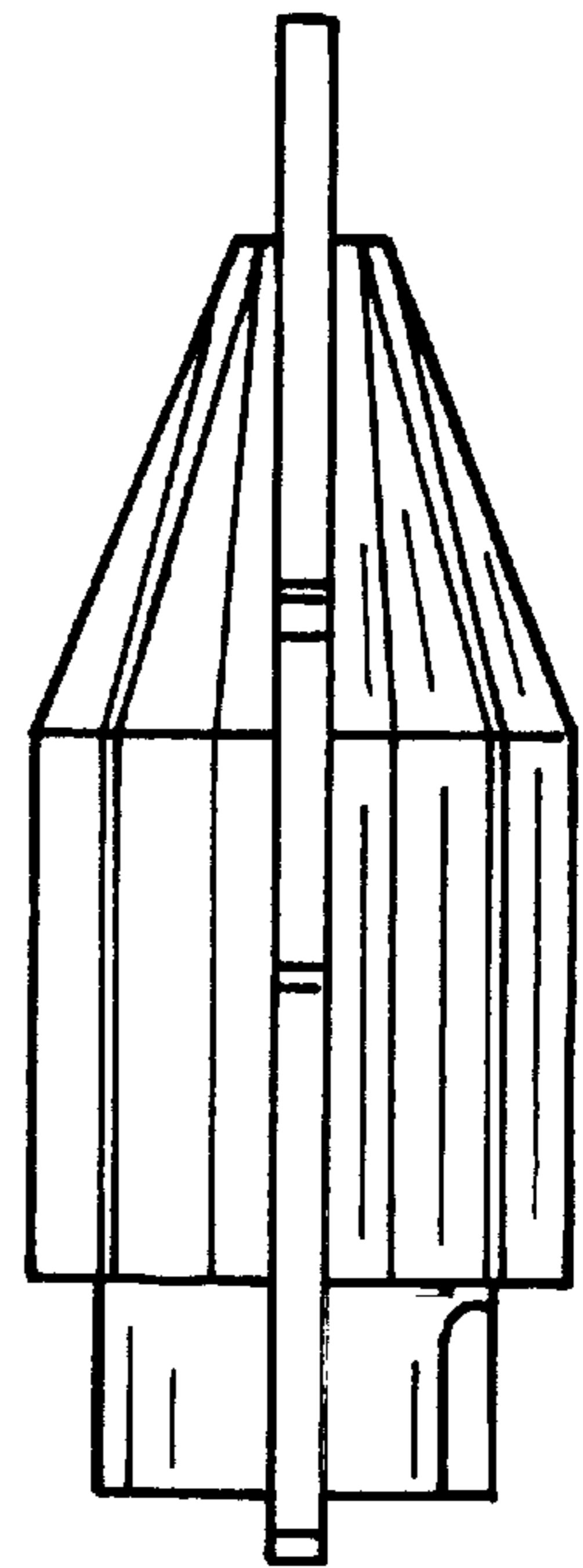
*Fig. 2*

*Fig. 3*

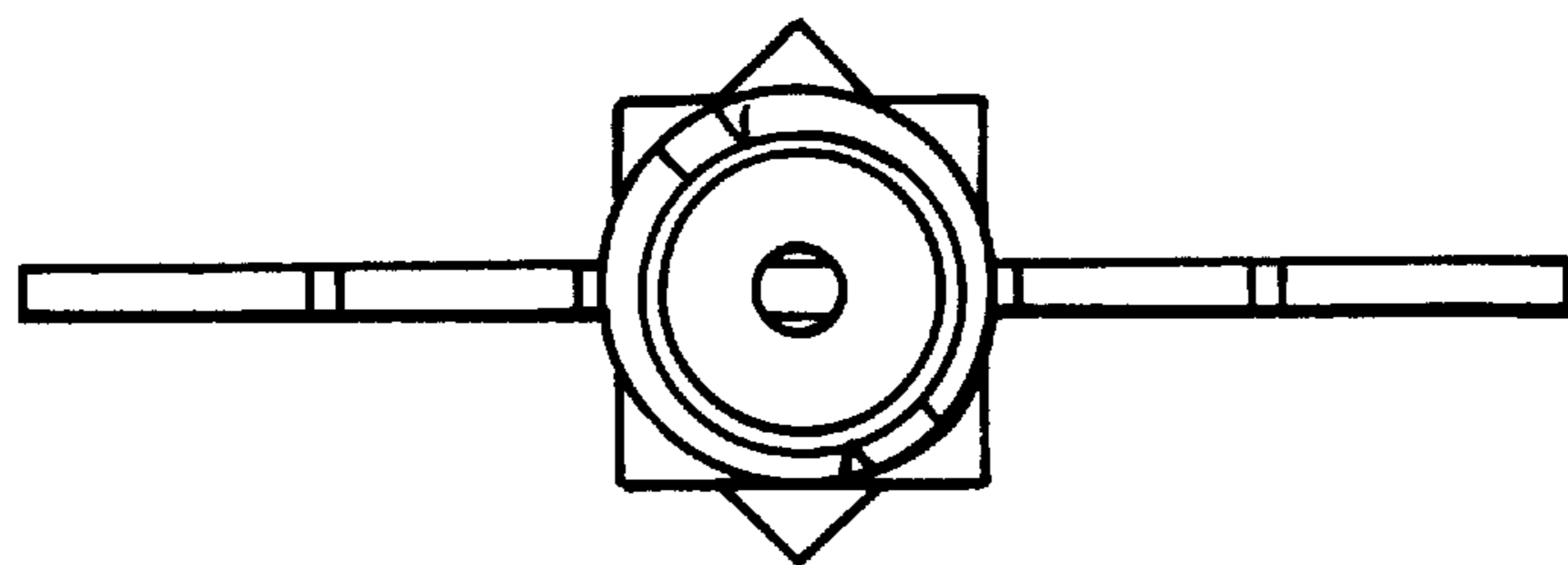




*Fig. 4*



*Fig. 5*



*Fig. 6*