



US00D403051S

**United States Patent** [19]  
**Lobermeier**

[11] **Patent Number: Des. 403,051**

[45] **Date of Patent: \*\*Dec. 22, 1998**

[54] **SHOWER FAUCET**

[75] Inventor: **Hans Lobermeier**, Menden, Germany

[73] Assignee: **Friedrich Grohe AG**, Hemer, Germany

[\*\*] Term: **14 Years**

[21] Appl. No.: **70,584**

[22] Filed: **May 12, 1997**

[30] **Foreign Application Priority Data**

Nov. 19, 1996 [DE] Germany ..... M96 09 977.1

[51] **LOC (6) Cl.** ..... **23-01**

[52] **U.S. Cl.** ..... **D23/241**

[58] **Field of Search** ..... D23/238-243,  
D23/250-257; 137/801; 4/675-678

[56] **References Cited**

**U.S. PATENT DOCUMENTS**

D. 347,264 5/1994 Gottwald ..... D23/238

D. 347,265 5/1994 Gottwald ..... D23/239  
D. 353,187 12/1994 Pormgren ..... D23/241  
D. 353,442 12/1994 Pormgren ..... D23/241

*Primary Examiner*—Doris V. Coles  
*Assistant Examiner*—Eric Watterson  
*Attorney, Agent, or Firm*—Herbert Dubno

[57] **CLAIM**

The ornamental design for a shower faucet, as shown.

**DESCRIPTION**

FIG. 1 is a top, front, left-side perspective view of a shower faucet showing my new design;  
FIG. 2 is a left side elevational view thereof, the right side being mirror symmetrical thereto;  
FIG. 3 is a top view thereof;  
FIG. 4 is a bottom view thereof;  
FIG. 5 is a rear elevational view thereof; and,  
FIG. 6 is a front view thereof.

**1 Claim, 4 Drawing Sheets**

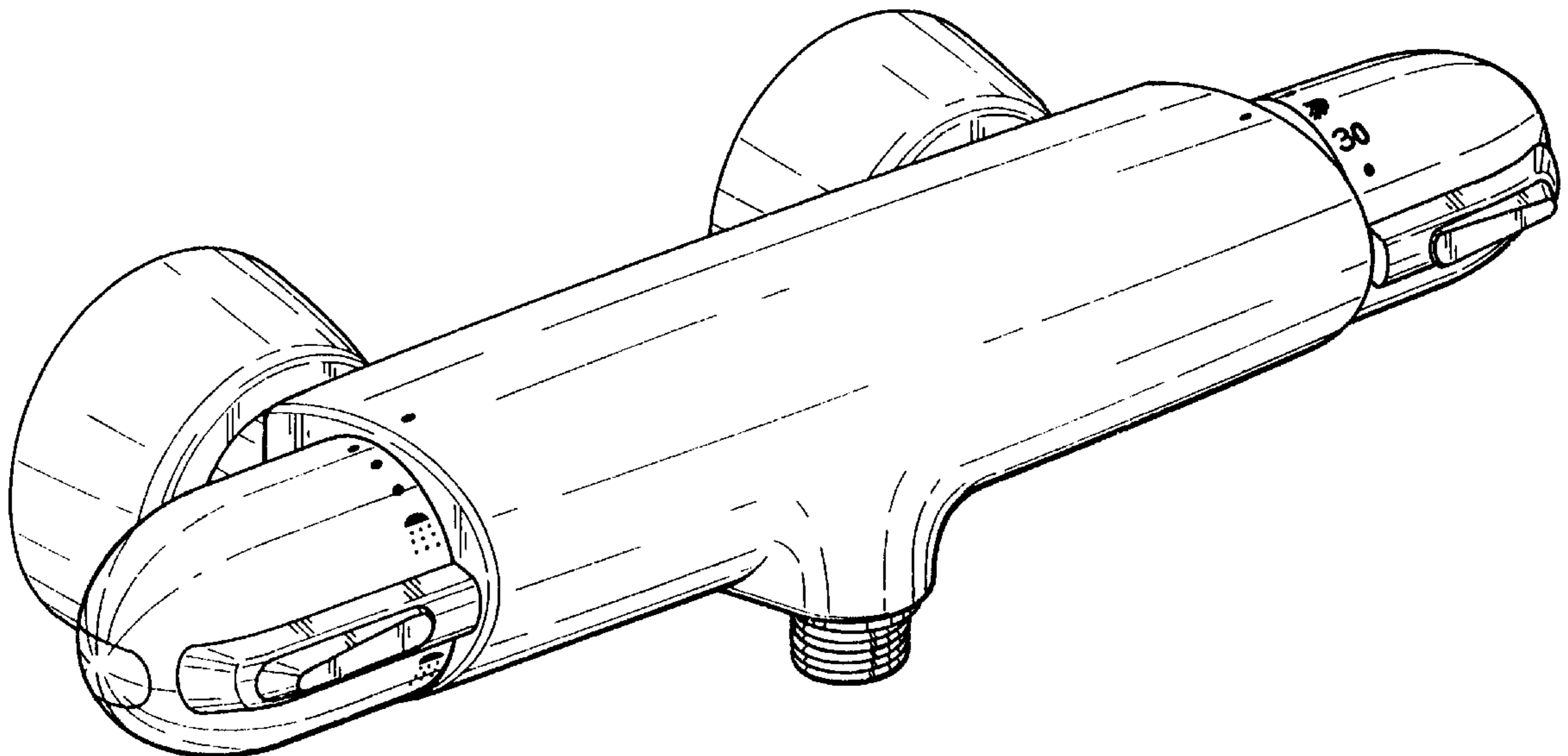

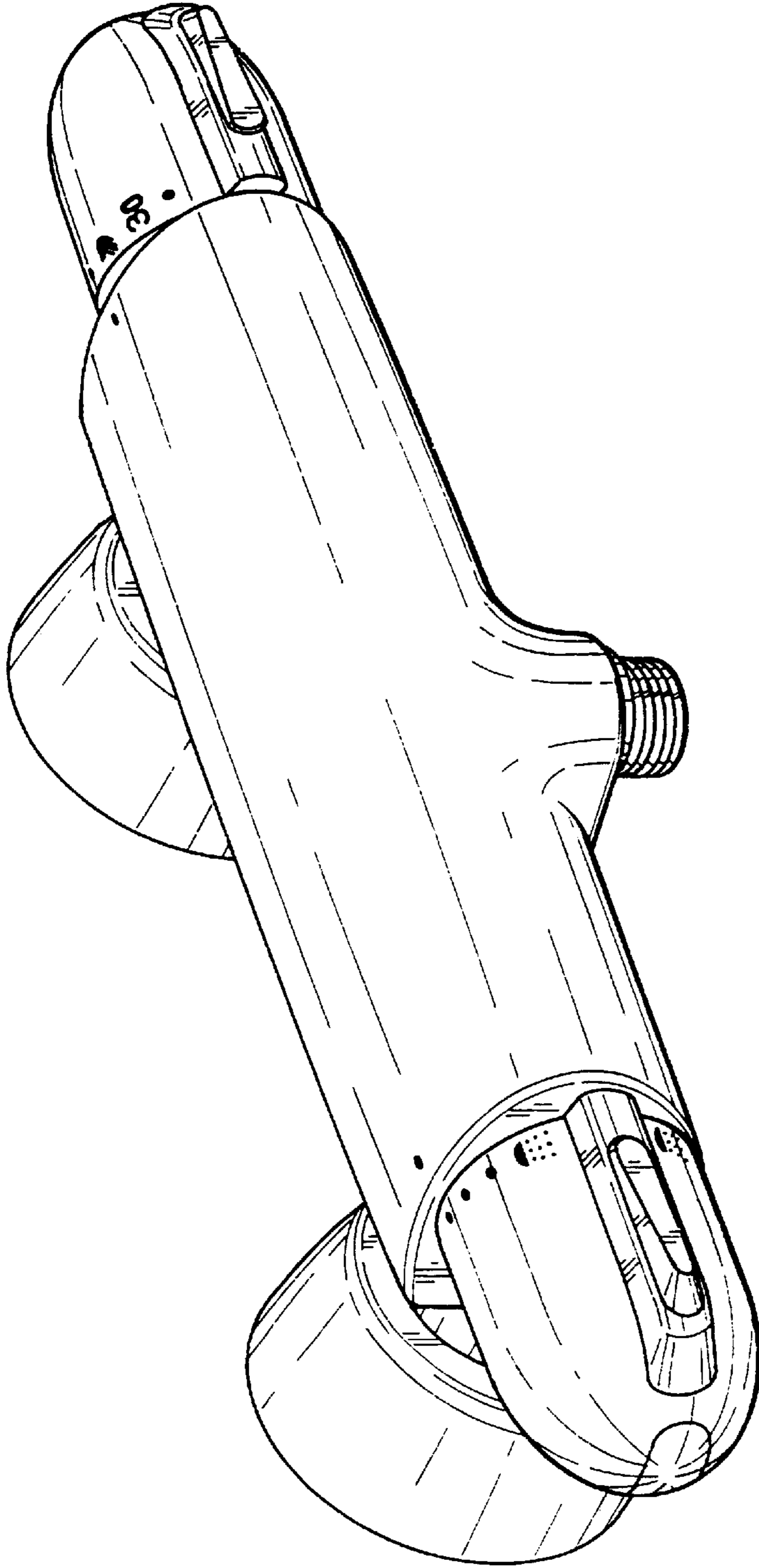

FIG. 2

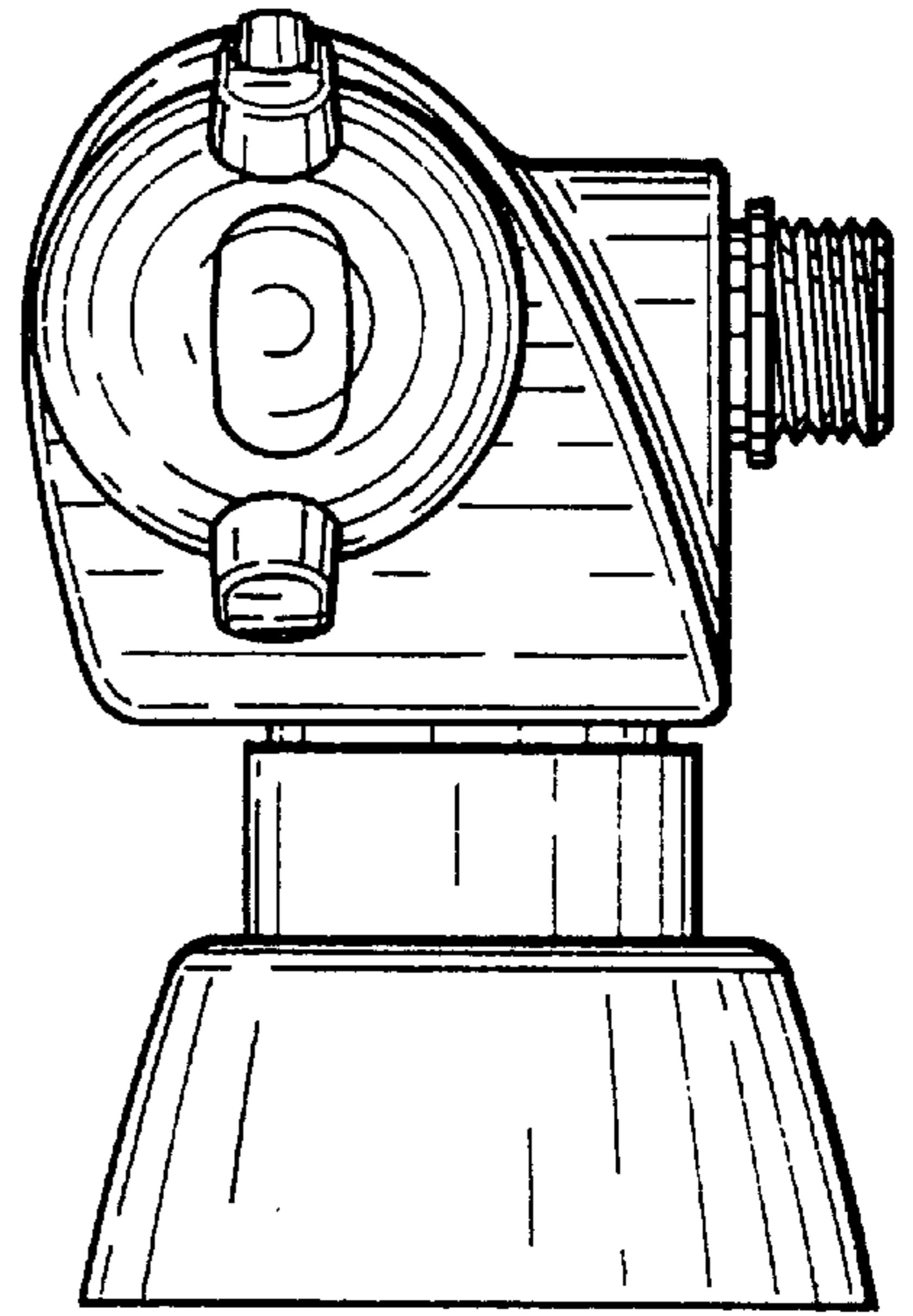

FIG. 1

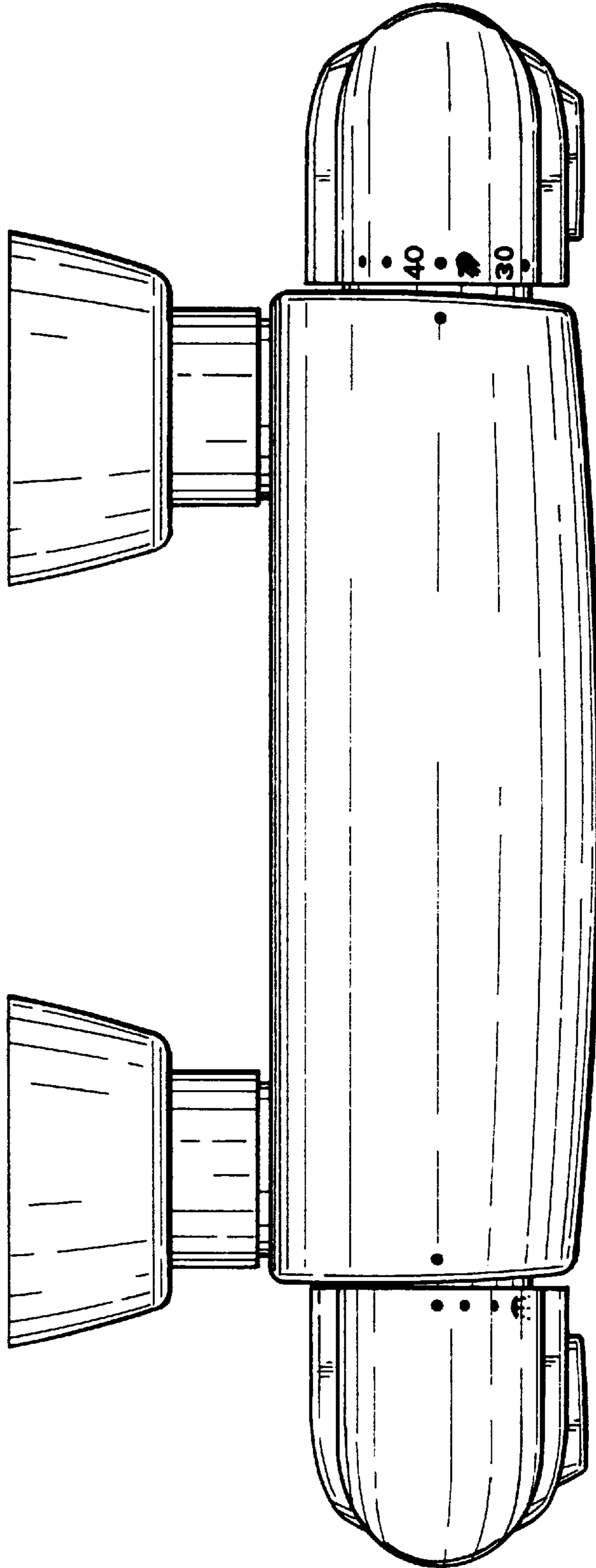

FIG. 3

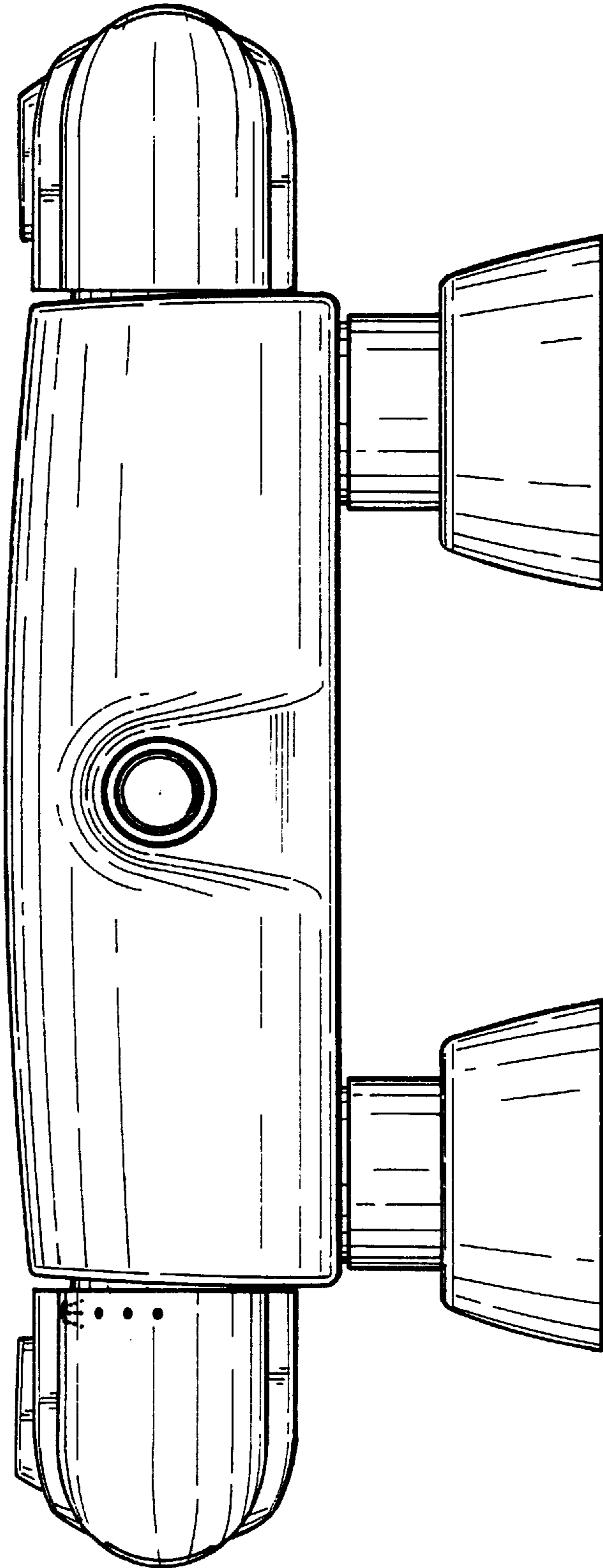

FIG. 4

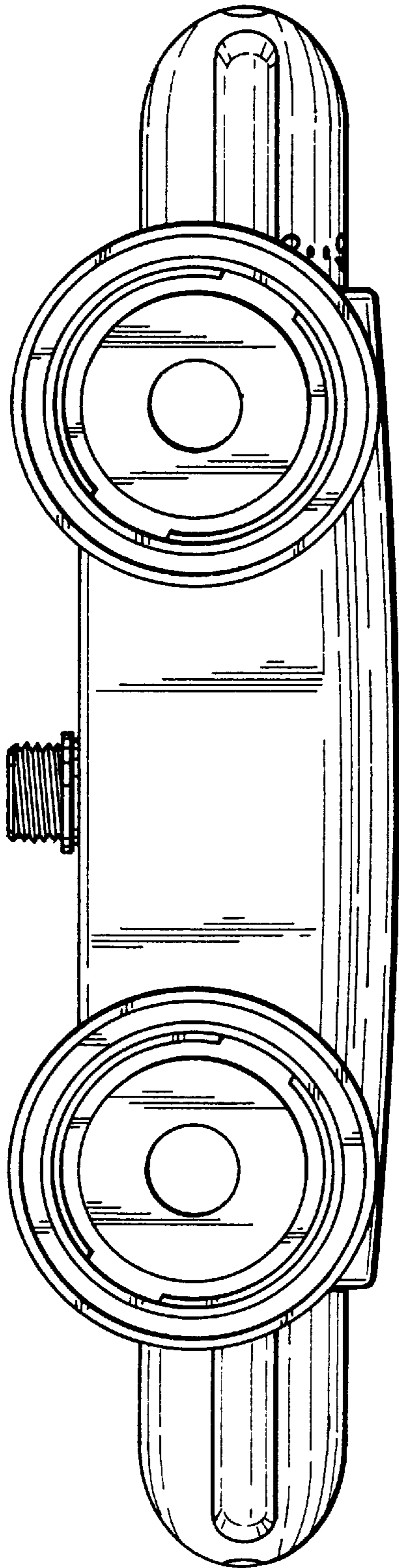

FIG. 5

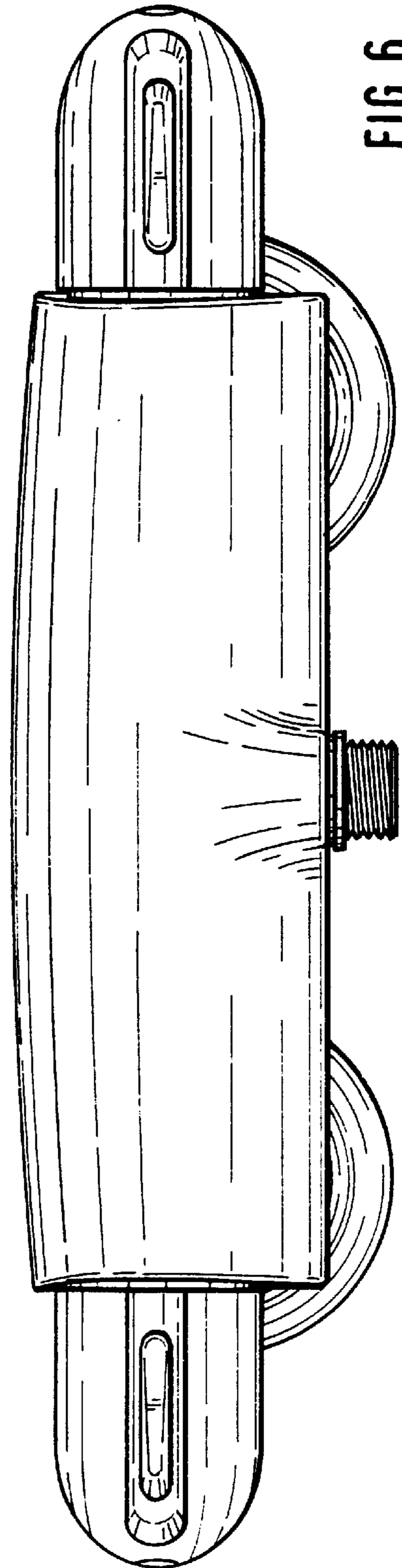

FIG. 6