

US00D402984S

# United States Patent [19]

Ito et al.

[11] **Patent Number: Des. 402,984**

[45] **Date of Patent: \*\*Dec. 22, 1998**

[54] **COMBINED AUDIO MIXER AND TAPE RECORDER**

D. 325,910	5/1992	Ito et al.	.....	D14/217 X
D. 326,454	5/1992	Ito et al.	.....	D14/162
5,257,317	10/1993	Stavrou	.....	381/119

[75] Inventors: **Masafumi Ito; Haruki Takita; Yasunobu Shimizu**, all of Musashino, Japan

*Primary Examiner*—Philip S. Hyder  
*Assistant Examiner*—Nanda Bondade  
*Attorney, Agent, or Firm*—Ladas & Parry

[73] Assignee: **Teac Corporation**, Tokyo, Japan

[\*\*] Term: **14 Years**

[57] **CLAIM**

The ornamental design for a combined audio mixer and tape recorder, as shown and described.

[21] Appl. No.: **84,116**

**DESCRIPTION**

[22] Filed: **Feb. 24, 1998**

[30] **Foreign Application Priority Data**

Aug. 27, 1997 [JP] Japan ..... 9-65917

FIG. 1 is a perspective view of a combined audio mixer and tape recorder showing our new design;  
FIG. 2 is a front view thereof;  
FIG. 3 is a read view thereof;  
FIG. 4 is a top view thereof;  
FIG. 5 is a bottom view thereof;  
FIG. 6 is a left side view thereof; and,  
FIG. 7 is a right side view thereof.

[51] **LOC (6) Cl.** ..... **14-01**

[52] **U.S. Cl.** ..... **D14/162; D14/217**

[58] **Field of Search** ..... D14/124, 162, D14/164, 217, 260; 381/28, 119; 379/202

[56] **References Cited**

**U.S. PATENT DOCUMENTS**

D. 291,196 8/1987 Ito et al. .... D14/162

**1 Claim, 3 Drawing Sheets**

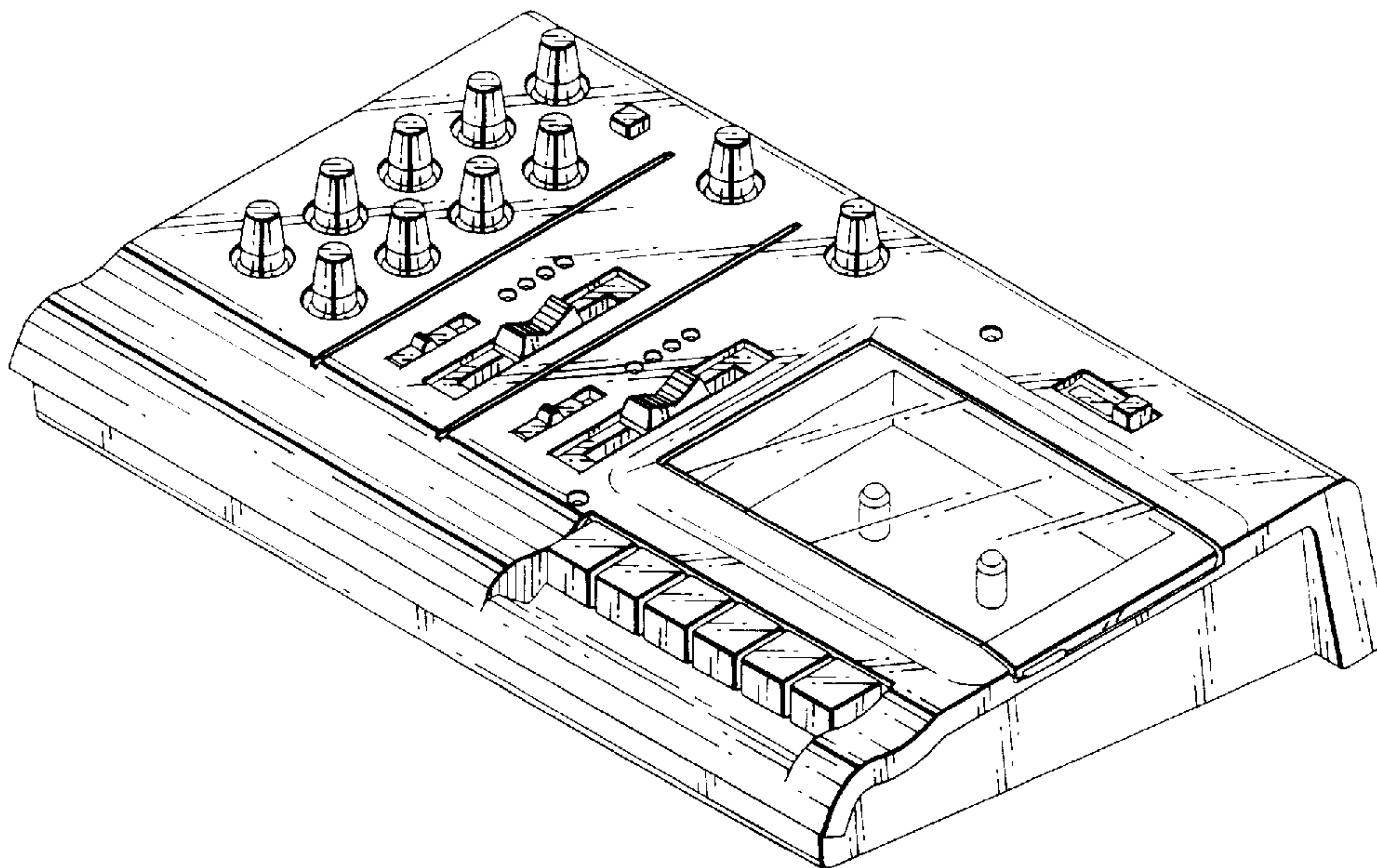

FIG. 1

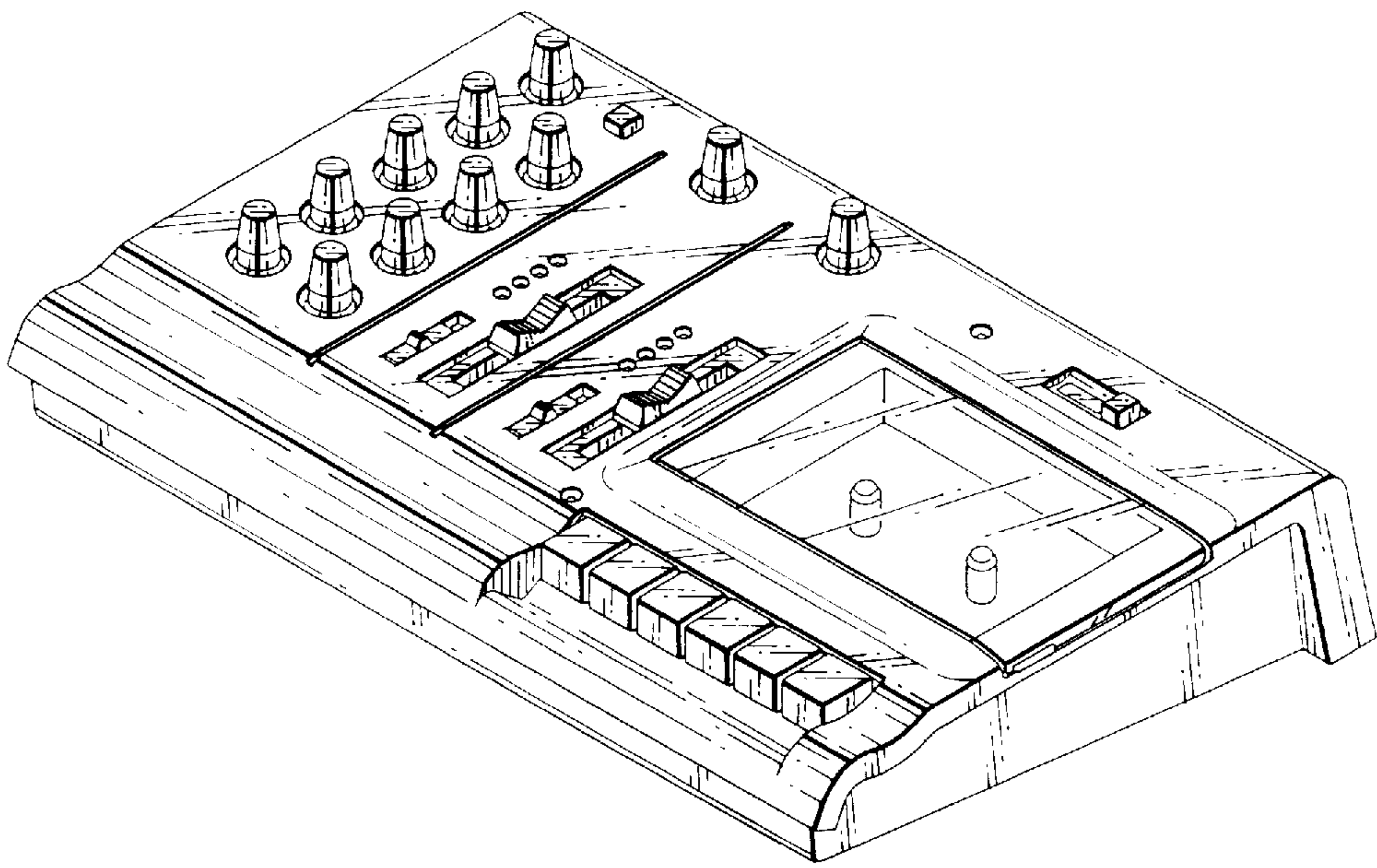

FIG. 2

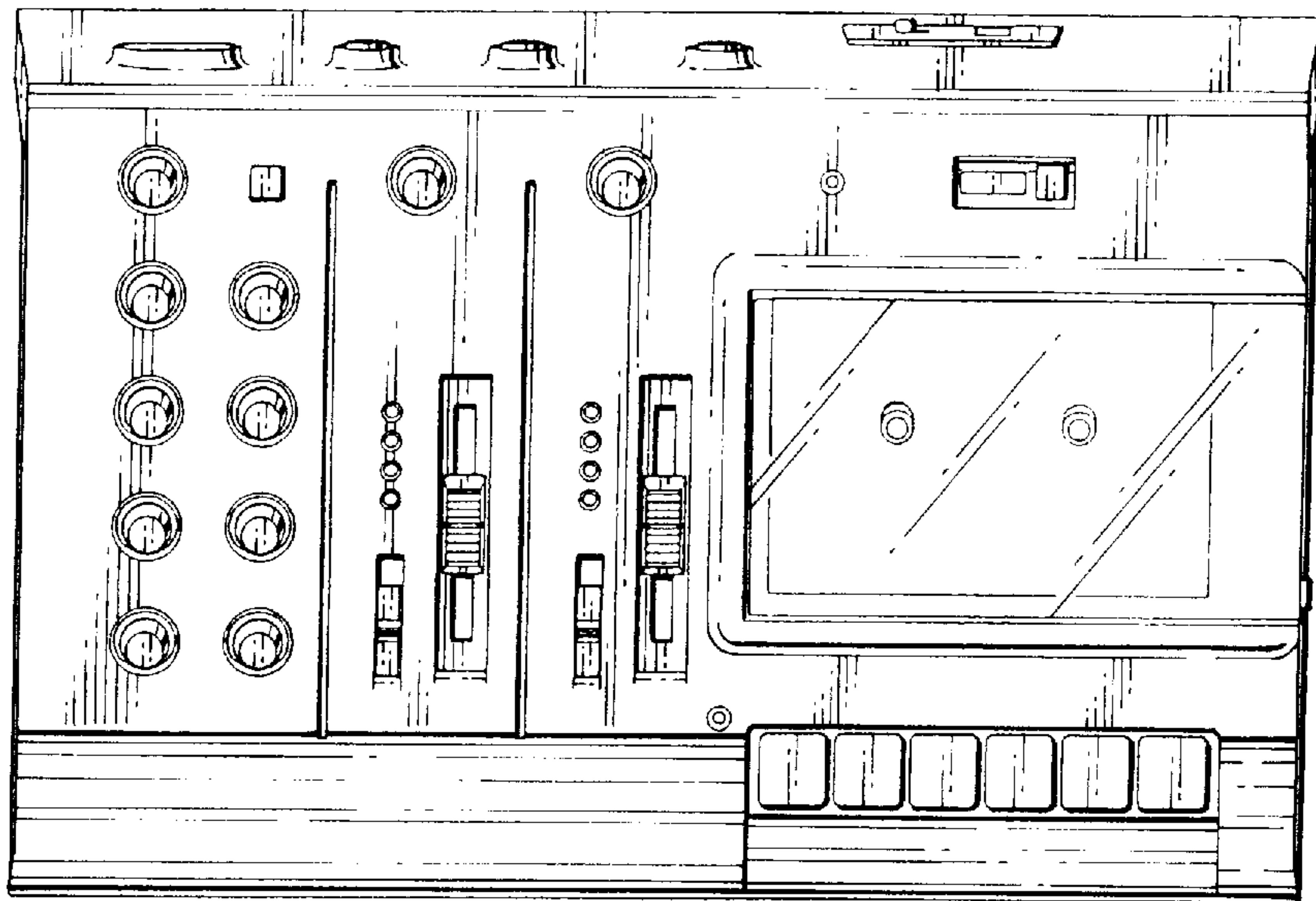

FIG. 3

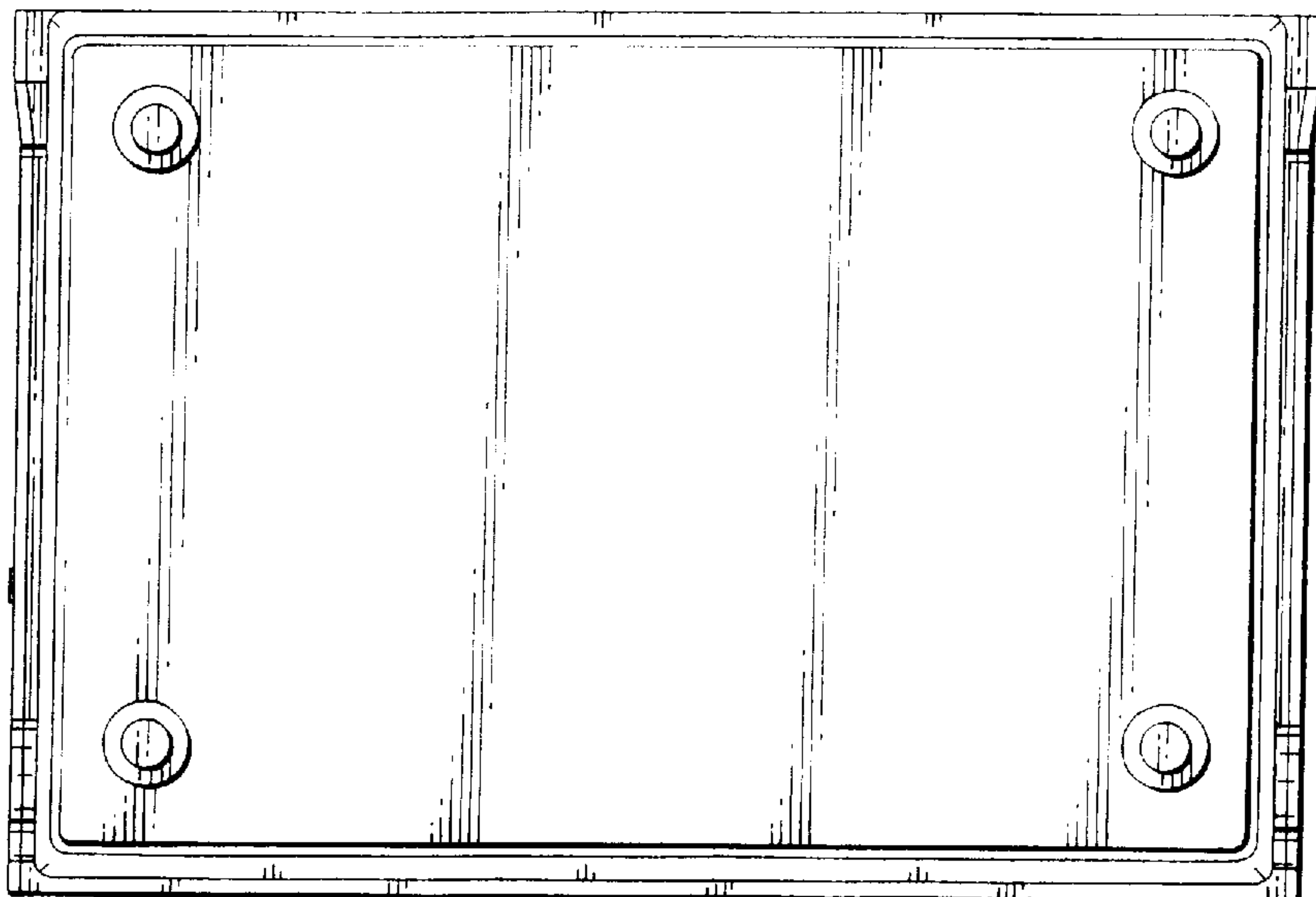

FIG. 4

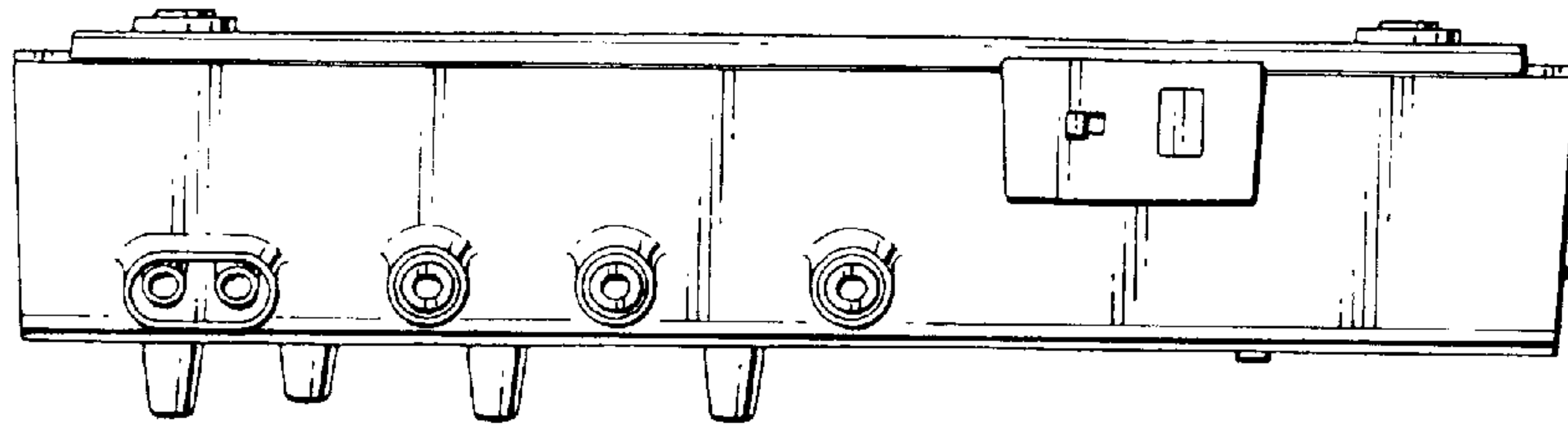

FIG. 5

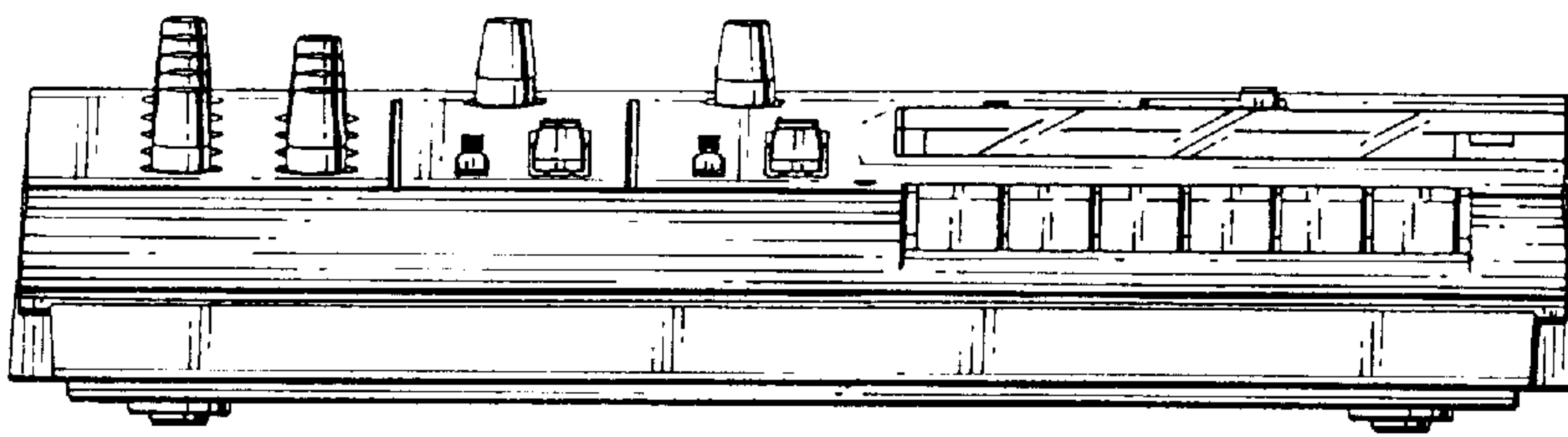

FIG. 6

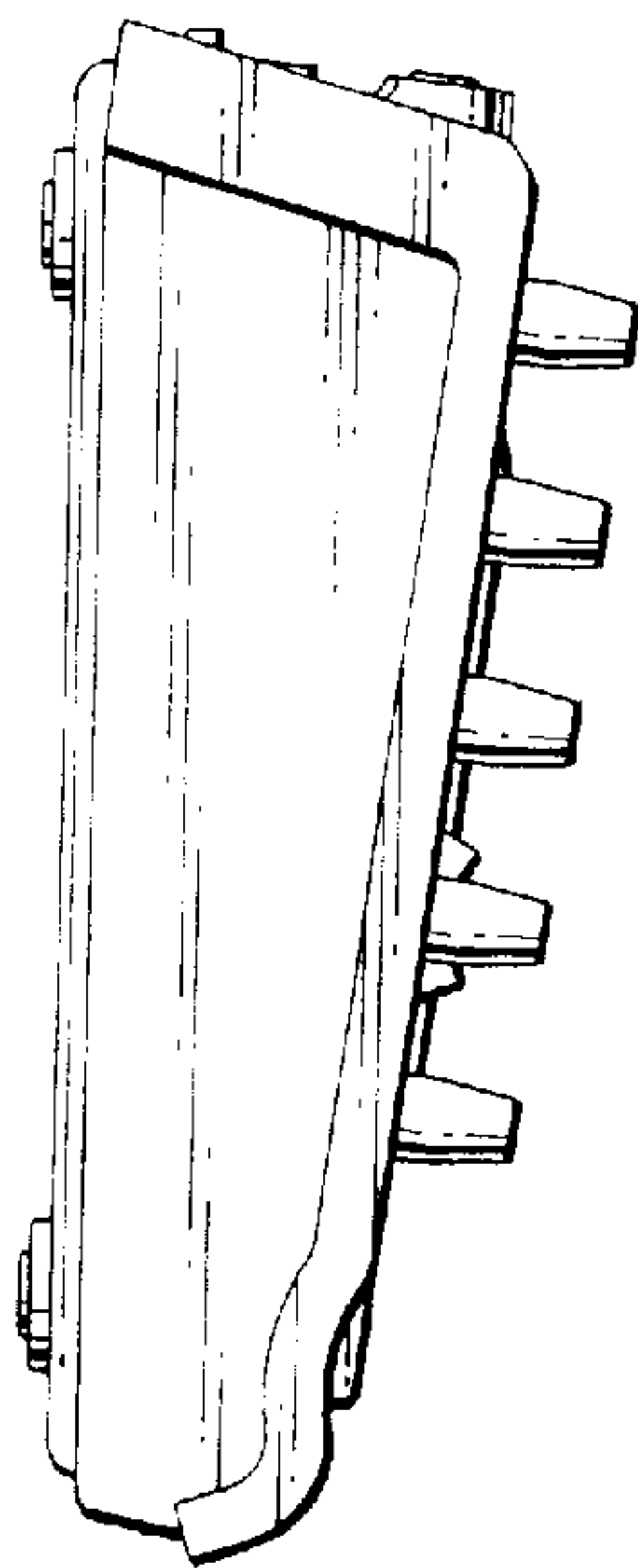

FIG. 7

