



US00D402780S

United States Patent [19] Alt

[11] **Patent Number:** **Des. 402,780**

[45] **Date of Patent:** ****Dec. 15, 1998**

[54] **LOBBY DUST PAN**

5,343,589 9/1994 Davenport 15/257.4
5,457,844 10/1995 Hanna et al. 15/257.1 X
5,715,564 2/1998 Knouse 15/257.1

[75] Inventor: **Steven J. Alt**, Perrysburg, Ohio

[73] Assignee: **Impact Products, Inc.**, Toledo, Ohio

[**] Term: **14 Years**

Primary Examiner—Susan J. Lucas
Assistant Examiner—Cynthia E. Ramirez
Attorney, Agent, or Firm—Donald R. Fraser

[21] Appl. No.: **87,412**

[57] **CLAIM**

[22] Filed: **May 1, 1998**

The ornamental design for a lobby dust pan, as shown and described.

[51] **LOC (6) Cl.** **07-05**

DESCRIPTION

[52] **U.S. Cl.** **D32/74**

[58] **Field of Search** D32/74; 15/257.1,
15/257.4, 257.8, 257.9

FIG. 1 is a top plan view of a lobby dust pan incorporating the features of the invention;
FIG. 2 is a front view thereof;
FIG. 3 is a right side elevational view thereof; the left side elevational view being a mirror image;
FIG. 4 is a rear elevational view thereof; and,
FIG. 5 is a bottom plan view thereof.

[56] **References Cited**

U.S. PATENT DOCUMENTS

D. 393,120 3/1998 Leonard et al. D32/74
5,012,542 5/1991 Lynn 15/257.1 X
5,325,565 7/1994 Suzuki 15/257.4

1 Claim, 2 Drawing Sheets

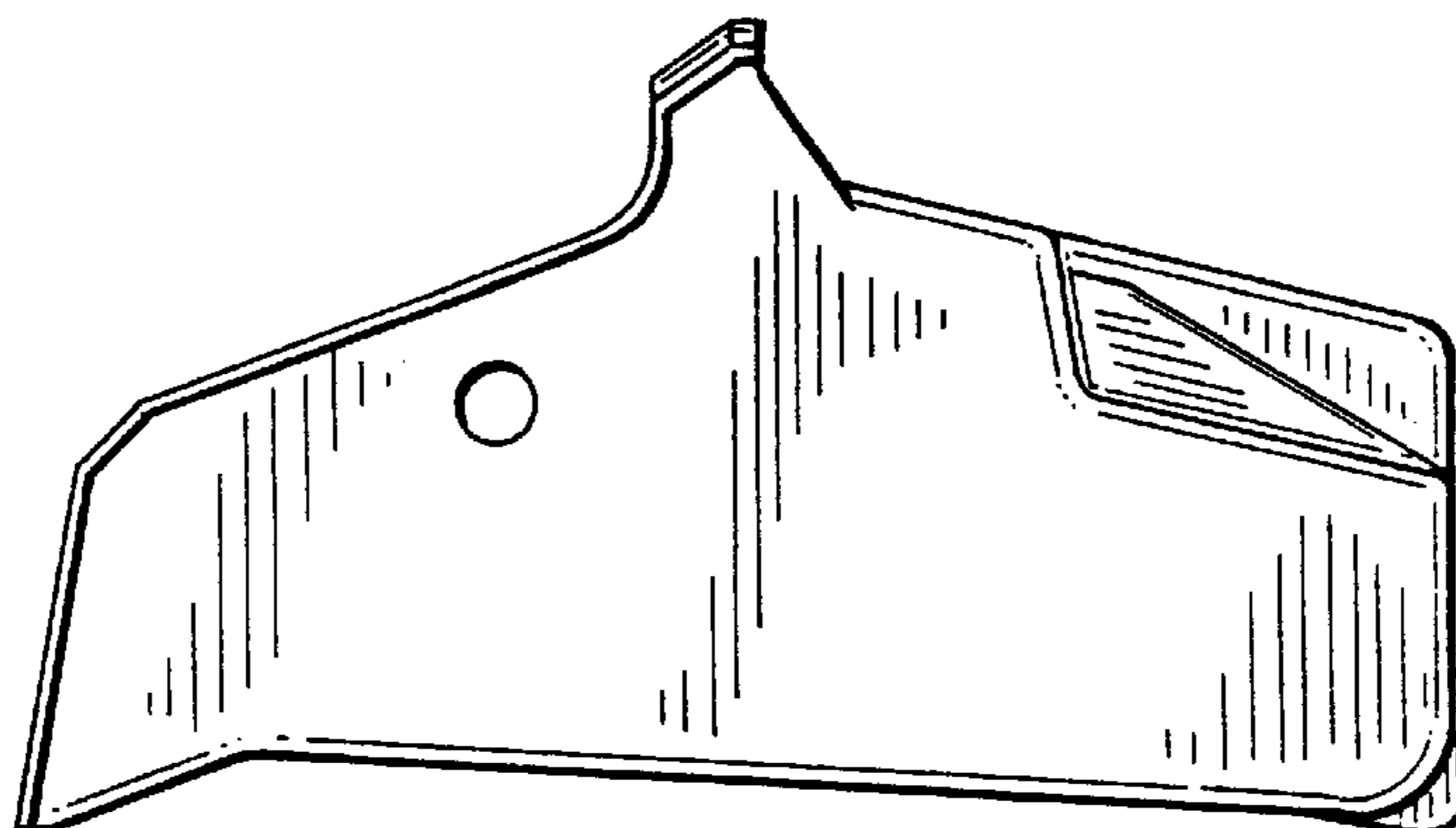
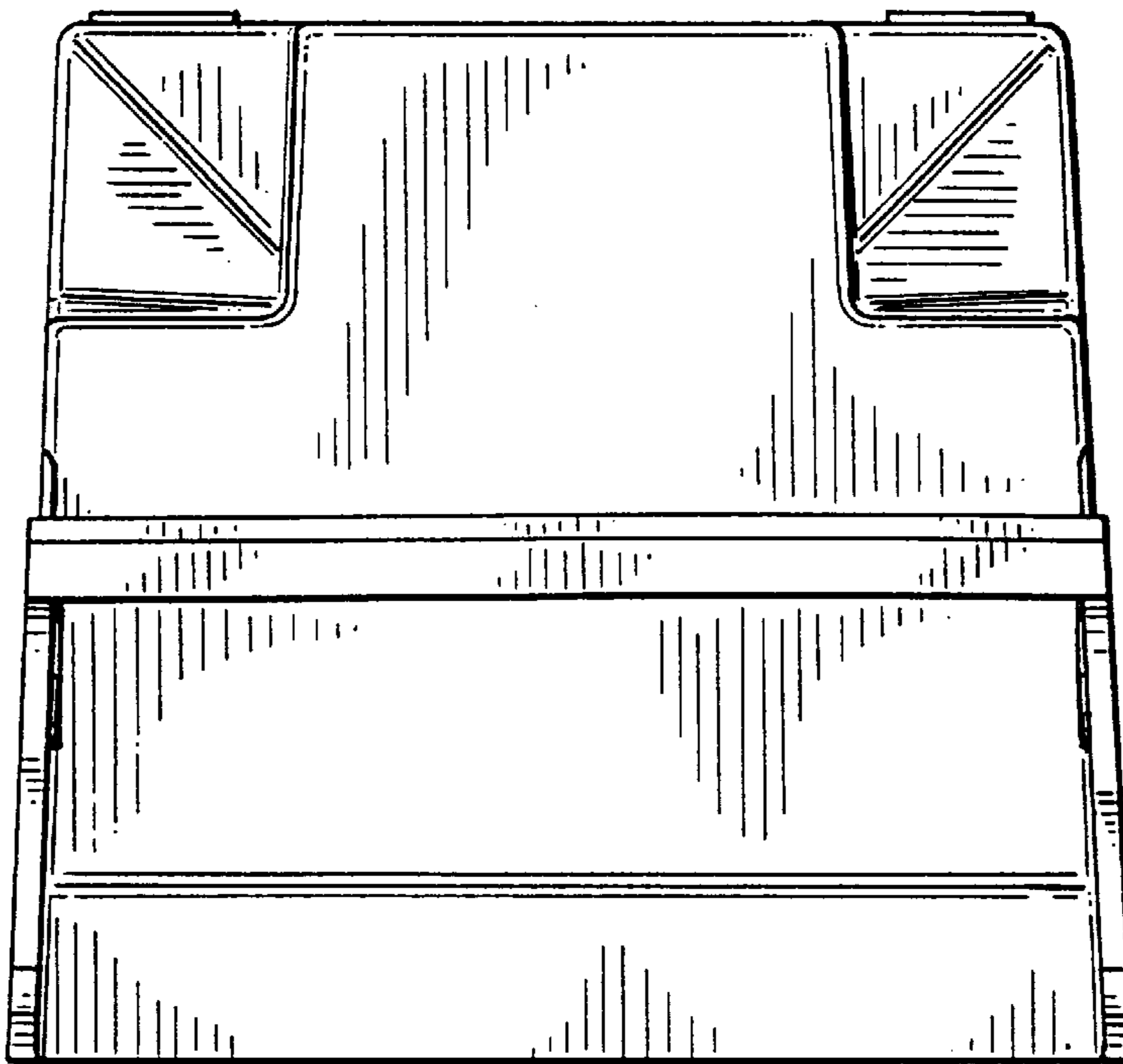

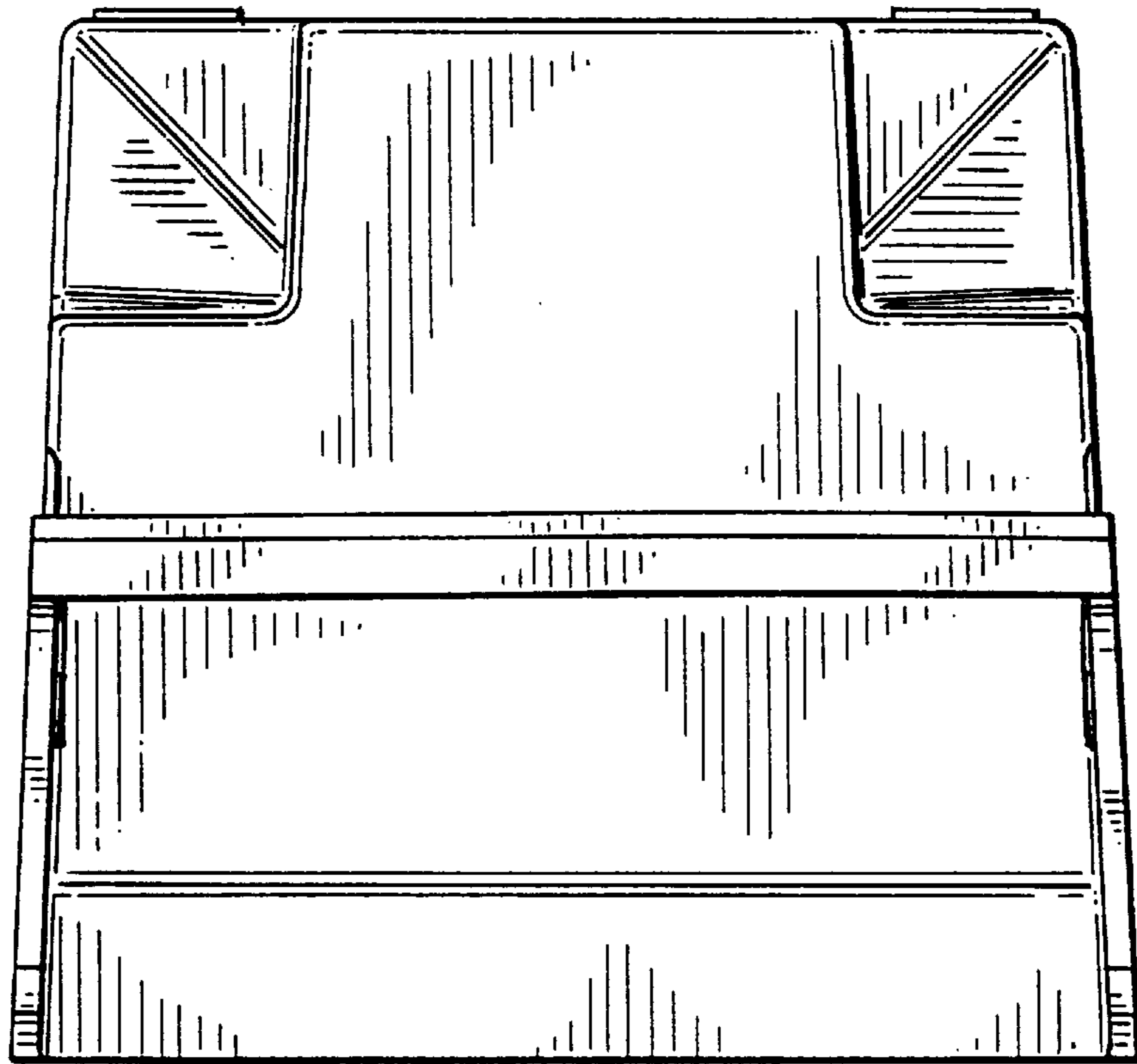

FIG. 1

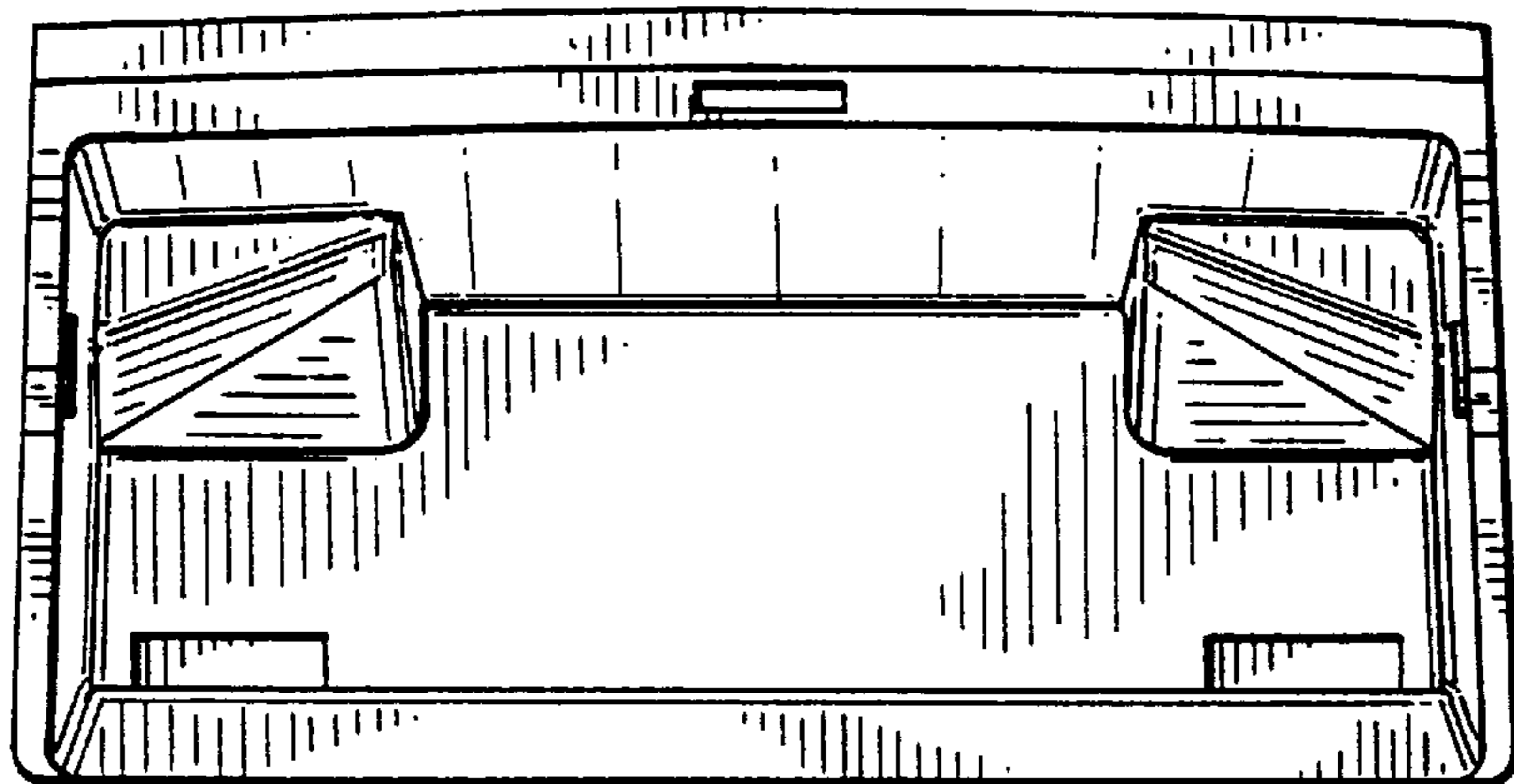

FIG. 2

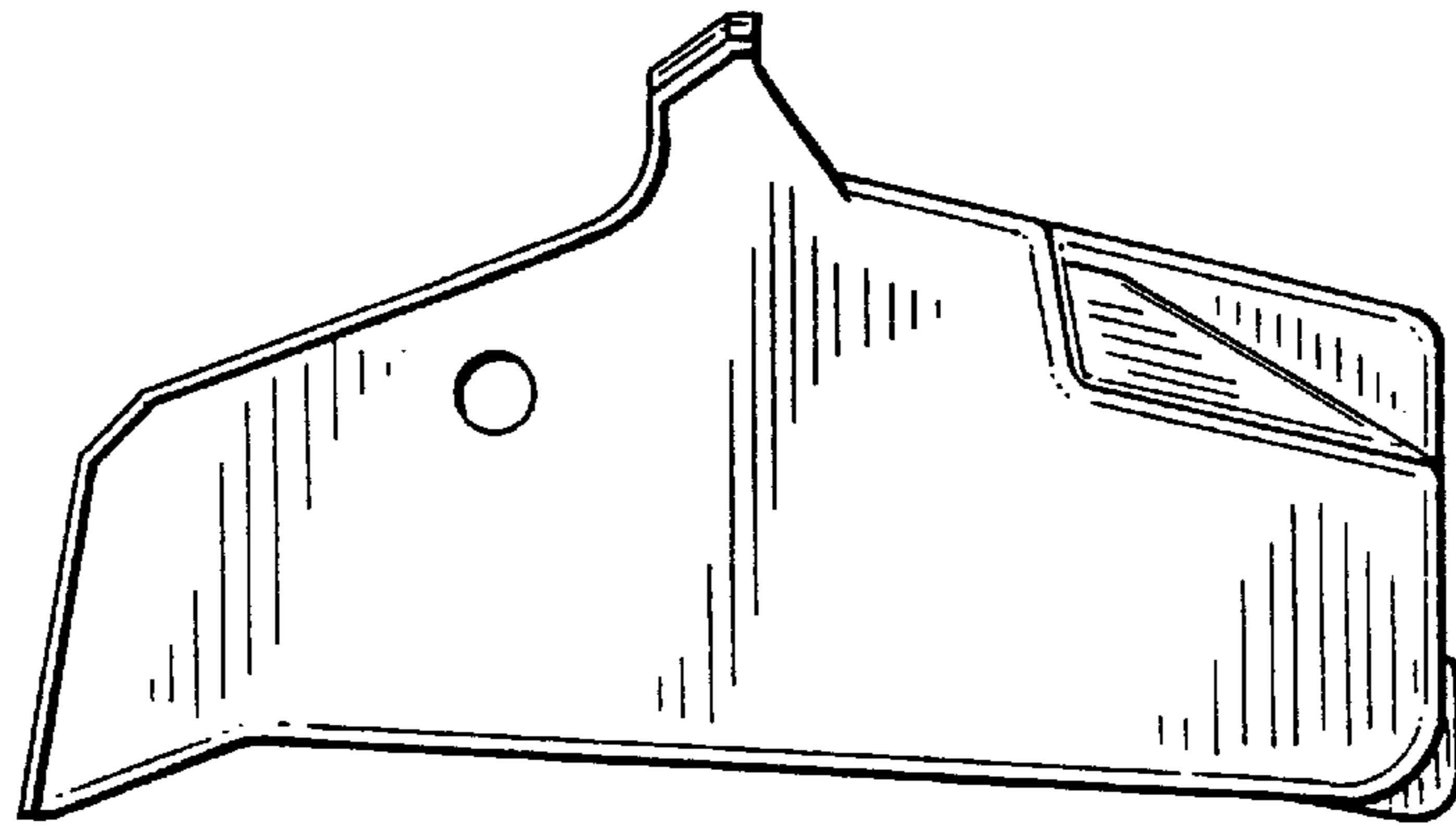

FIG. 3

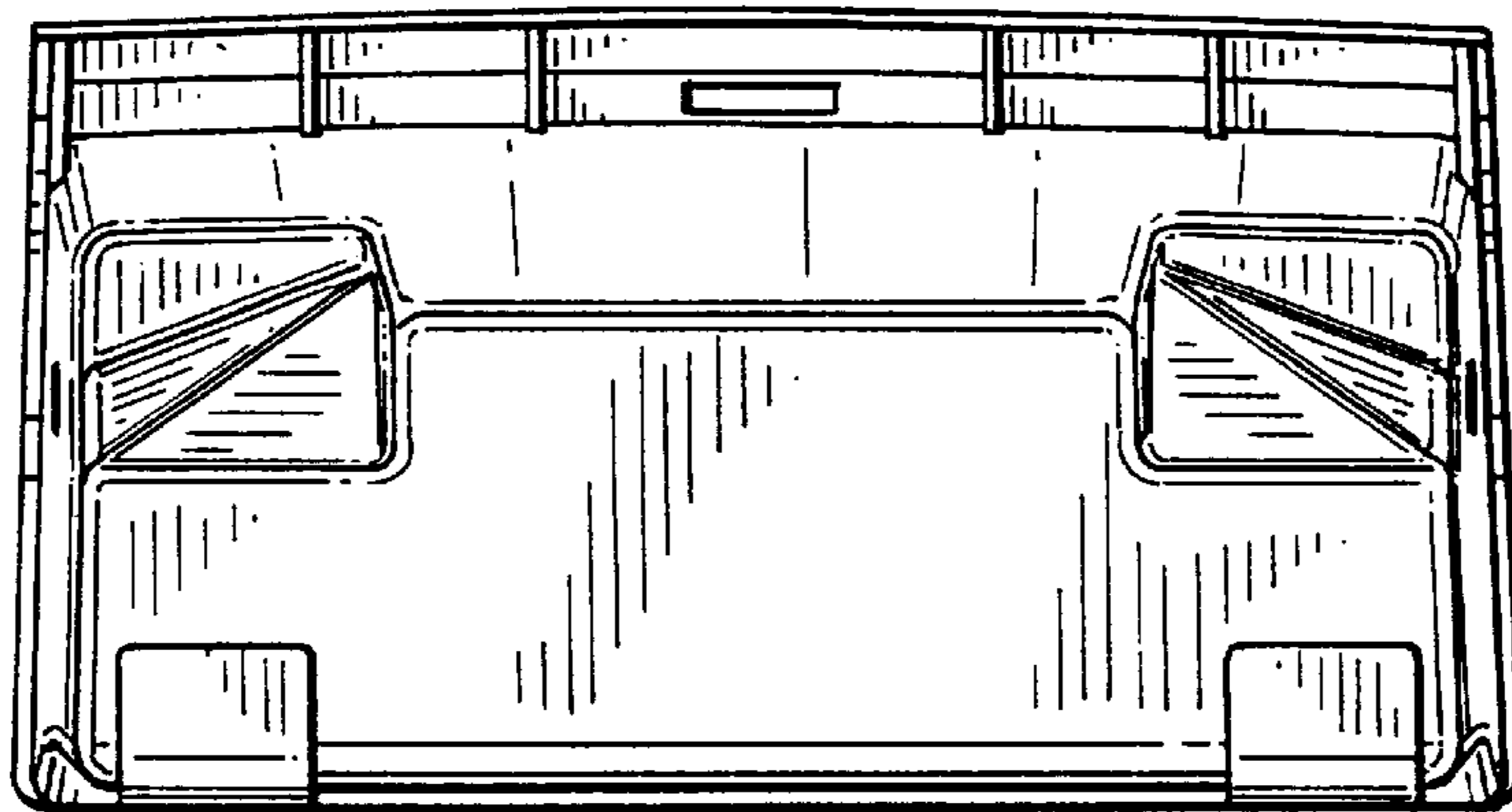

FIG. 4

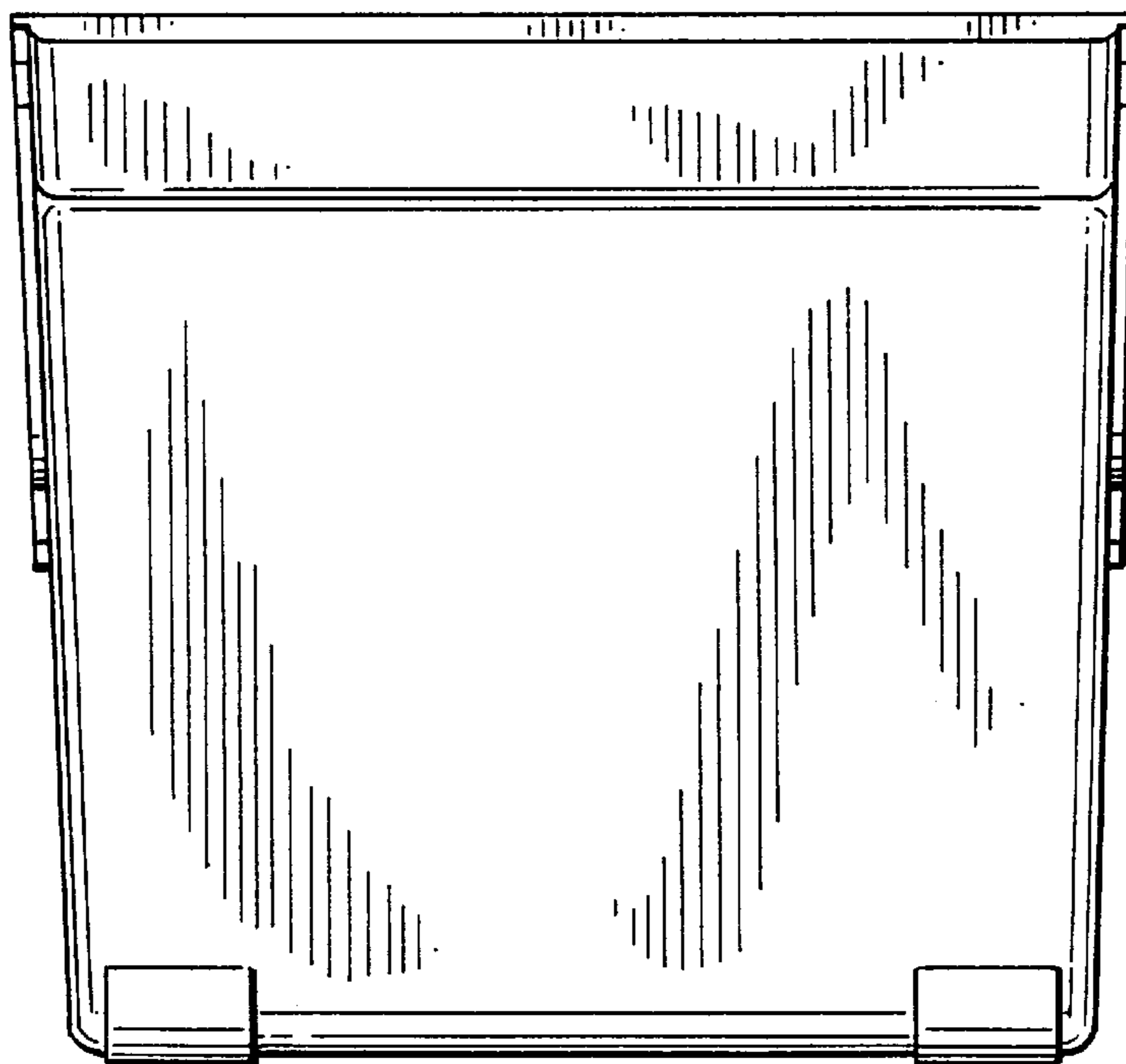

FIG. 5