



US00D402704S

**United States Patent** [19]  
**Keener**

[11] **Patent Number: Des. 402,704**

[45] **Date of Patent: \*\*Dec. 15, 1998**

[54] **STUFFED TOY**

[76] Inventor: **Daniel W. Keener**, 185 Marra Ave.,  
Washington, Pa. 15301

[\*\*] Term: **14 Years**

[21] Appl. No.: **74,493**

[22] Filed: **Jul. 31, 1997**

[51] **LOC (6) Cl.** ..... **21-01**

[52] **U.S. Cl.** ..... **D21/166**

[58] **Field of Search** ..... D21/184, 166,  
D21/171, 155, 172; D11/160, 131; 446/268,  
369

[56] **References Cited**

**U.S. PATENT DOCUMENTS**

D. 232,040 7/1974 Pendill ..... D21/166  
D. 262,591 1/1982 Cardenas et al. .... D11/160 X

D. 281,237 11/1985 Zusman ..... D11/160  
D. 292,302 10/1987 Hale ..... D21/166 X  
D. 336,943 6/1993 Ekstein ..... D21/166 X  
D. 340,959 11/1993 Warble ..... D21/184

*Primary Examiner*—Lucy Lieberman

[57] **CLAIM**

The ornamental design for a stuffed toy, as shown.

**DESCRIPTION**

FIG. 1 is a front view of the stuffed toy of the present invention;

FIG. 2 is a back view of the stuffed toy of FIG. 1;

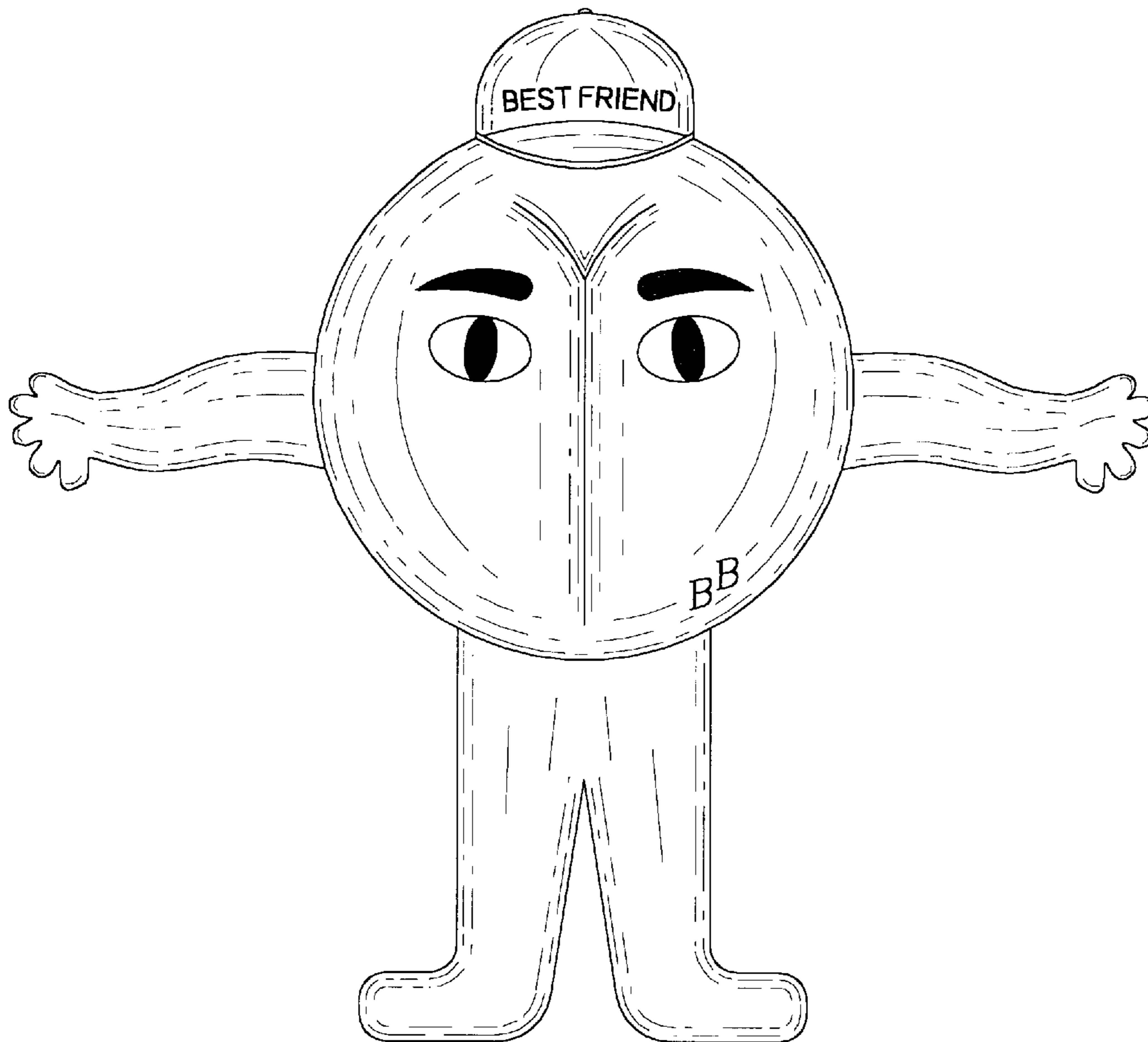
FIG. 3 is a left side view of the stuffed toy of FIG. 1;

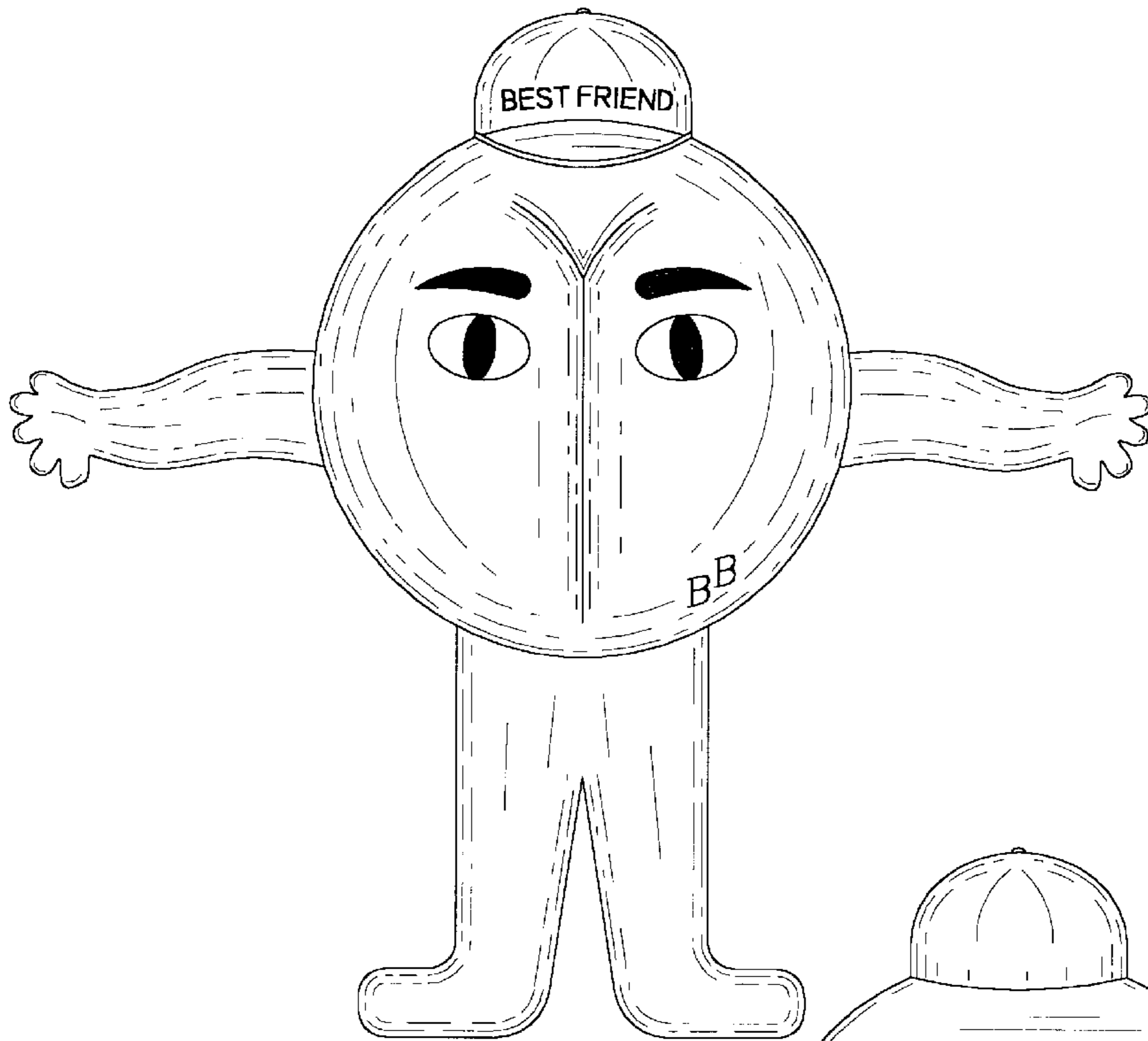
FIG. 4 is a right side view of the stuffed toy of FIG. 1;

FIG. 5 is a top plan view of the stuffed toy of FIG. 1; and,

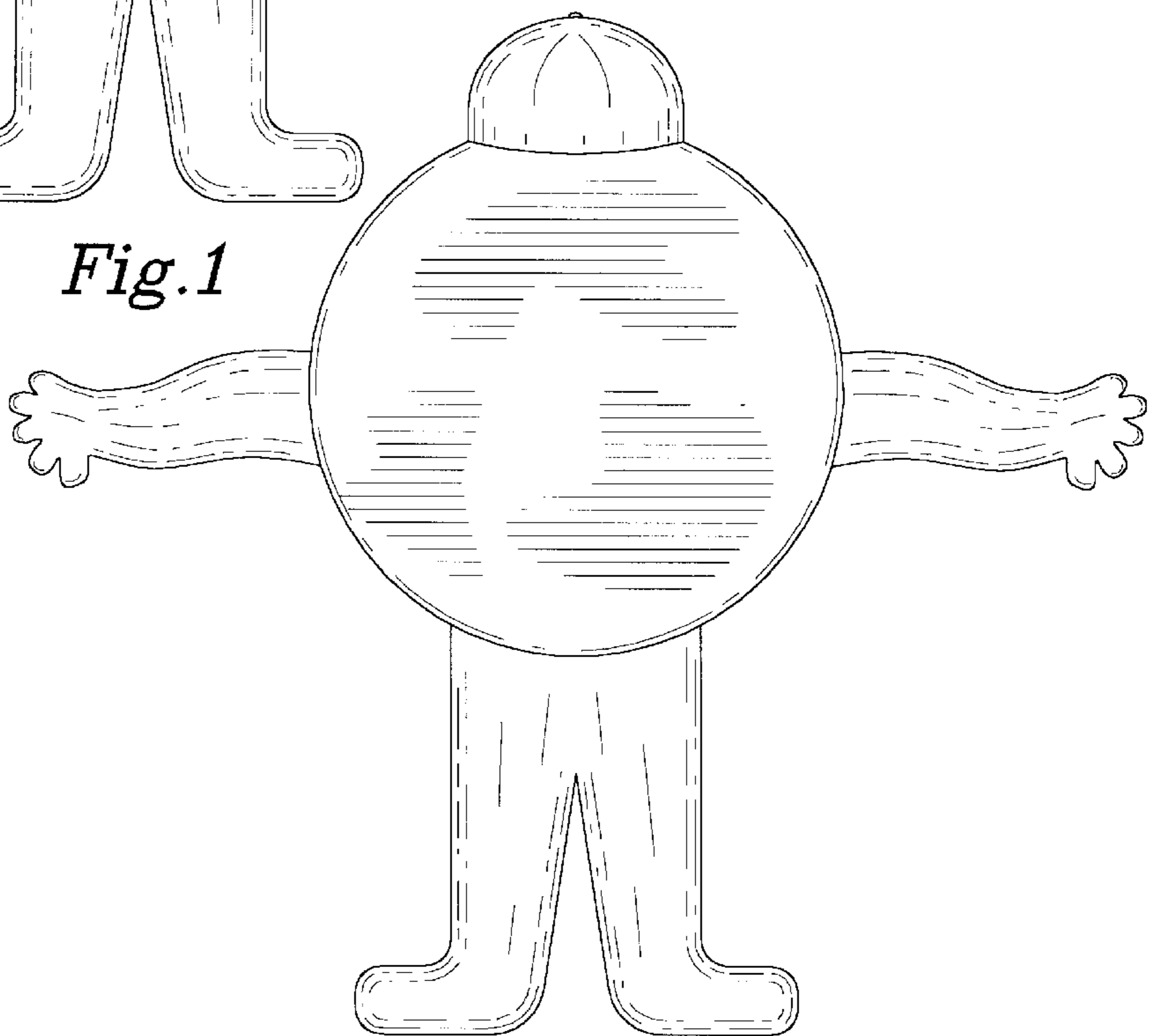
FIG. 6 is a bottom plan view of the stuffed toy of FIG. 1.

**1 Claim, 3 Drawing Sheets**

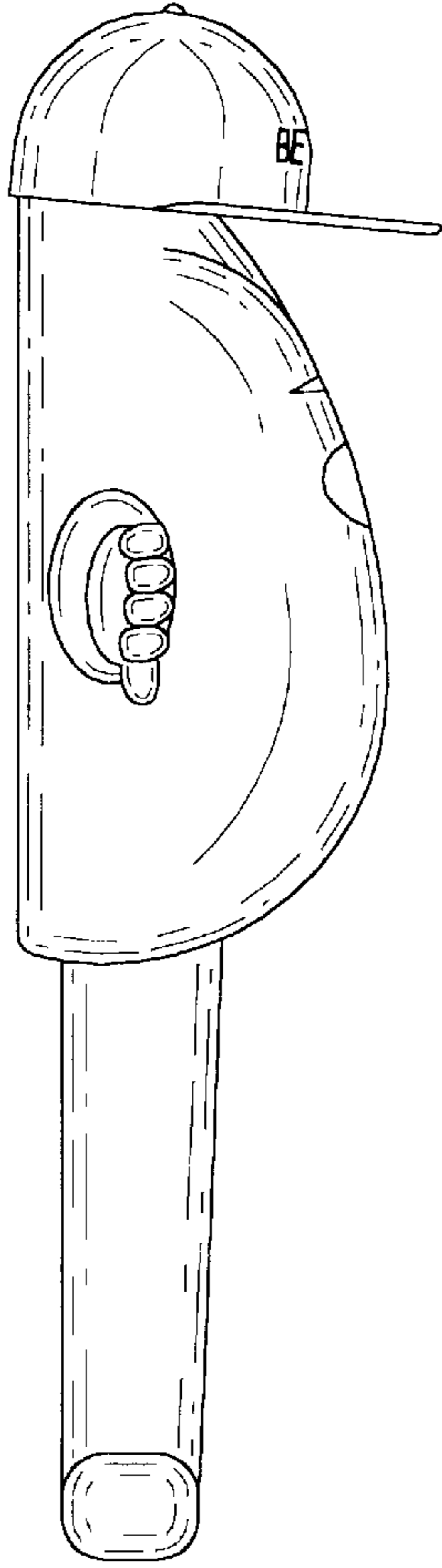




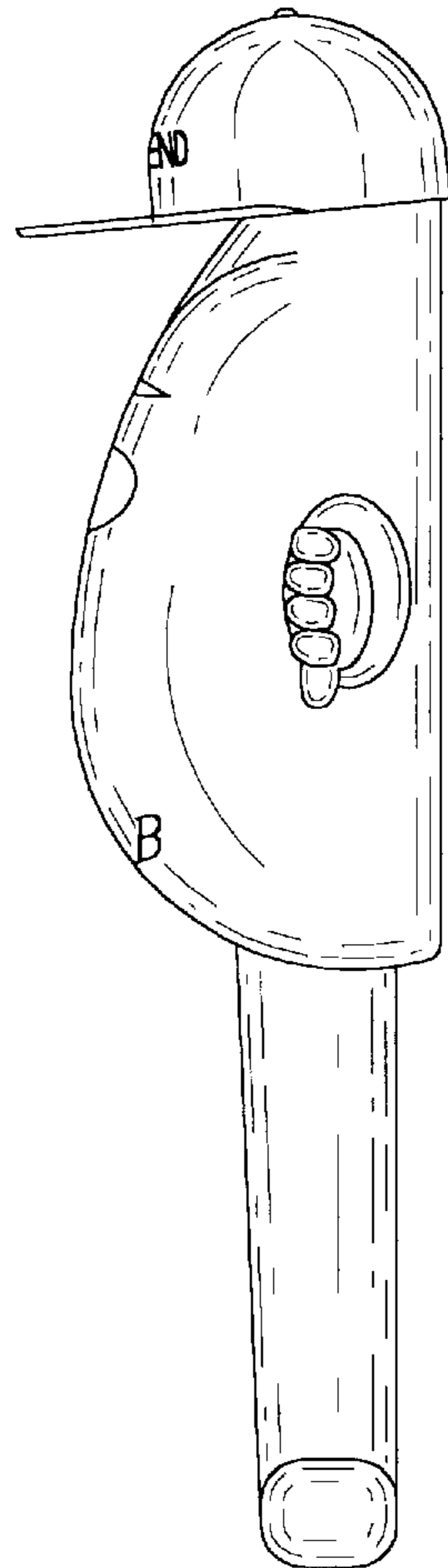
*Fig.1*



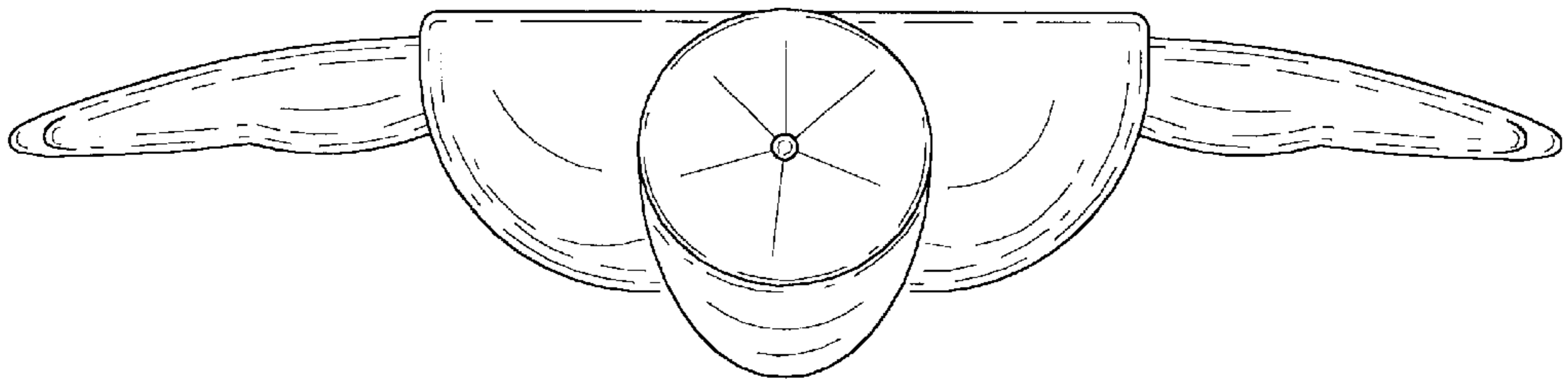
*Fig.2*



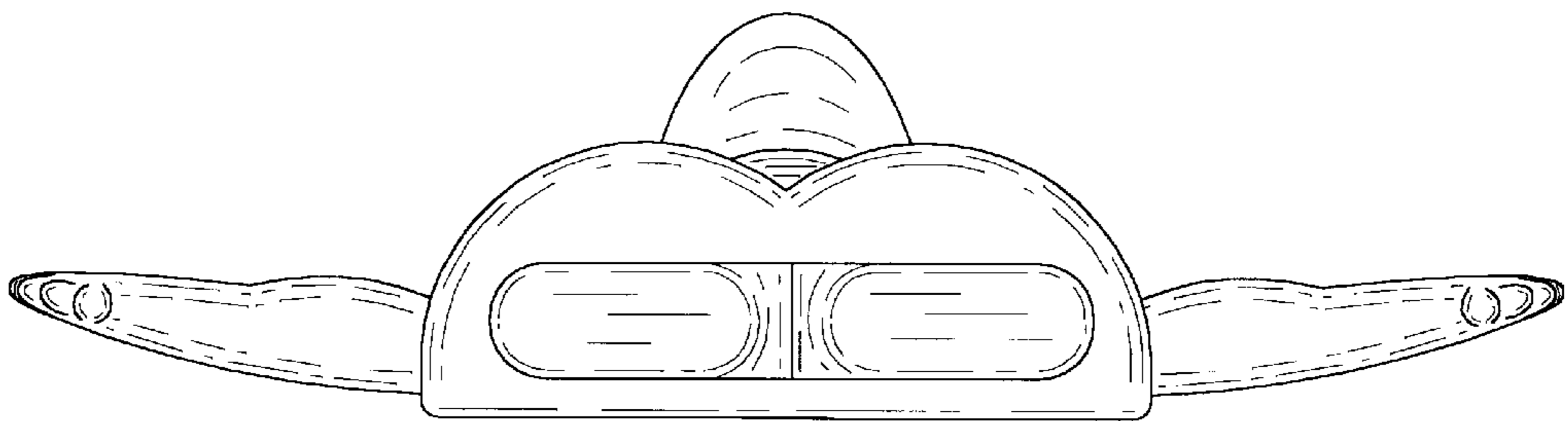
*Fig. 3*



*Fig. 4*



*Fig. 5*



*Fig. 6*