



US00D402658S

United States Patent [19]
Hyogo

[11] **Patent Number: Des. 402,658**

[45] **Date of Patent: **Dec. 15, 1998**

[54] **SPEAKER BOX**

[75] Inventor: **Kuninori Hyogo**, Tokyo, Japan

[73] Assignee: **Sony Corporation**, Tokyo, Japan

[**] Term: **14 Years**

[21] Appl. No.: **65,450**

[22] Filed: **Jan. 30, 1997**

[51] **LOC (6) Cl.** **14-01**

[52] **U.S. Cl.** **D14/215; D14/214**

[58] **Field of Search** D14/204, 207-216,
D14/219, 221; 181/144, 145, 147, 148,
150, 152, 153, 157, 198, 199; 381/24, 88,
90, 153, 159, 186, 188, 203, 205

[56] **References Cited**

U.S. PATENT DOCUMENTS

D. 272,343	1/1984	Matsubara	D14/214
D. 276,153	10/1984	Iijima	D14/214
D. 281,597	12/1985	Matsushima	D14/214
D. 283,124	3/1986	Kolb	D14/210 X
D. 324,864	3/1992	Hector	D14/210
D. 350,136	8/1994	Kim	D14/214 X

Primary Examiner—Ted Shooman
Assistant Examiner—Nanda Bondade

Attorney, Agent, or Firm—Foley & Lardner

[57] **CLAIM**

The ornamental design for a speaker box, as shown and described.

DESCRIPTION

FIG. 1 is a perspective view of a first embodiment of a speaker box showing my new design;
FIG. 2 is a top plan view thereof;
FIG. 3 is a left side elevational view thereof, a right side elevational view being a mirror image;
FIG. 4 is a front elevational view thereof;
FIG. 5 is a bottom plan view thereof;
FIG. 6 is a rear elevational view thereof;
FIG. 7 is a perspective view of a second embodiment of a speaker box showing my new design;
FIG. 8 is a top plan view of the embodiment of FIG. 7;
FIG. 9 is a left side elevational view of the embodiment of FIG. 7;
FIG. 10 is a front elevational view of the embodiment of FIG. 7;
FIG. 11 is a bottom plan view of the embodiment of FIG. 7;
FIG. 12 is a right side elevational view of the embodiment of FIG. 7; and,
FIG. 13 is a rear elevational view of the embodiment of FIG. 7.

1 Claim, 6 Drawing Sheets

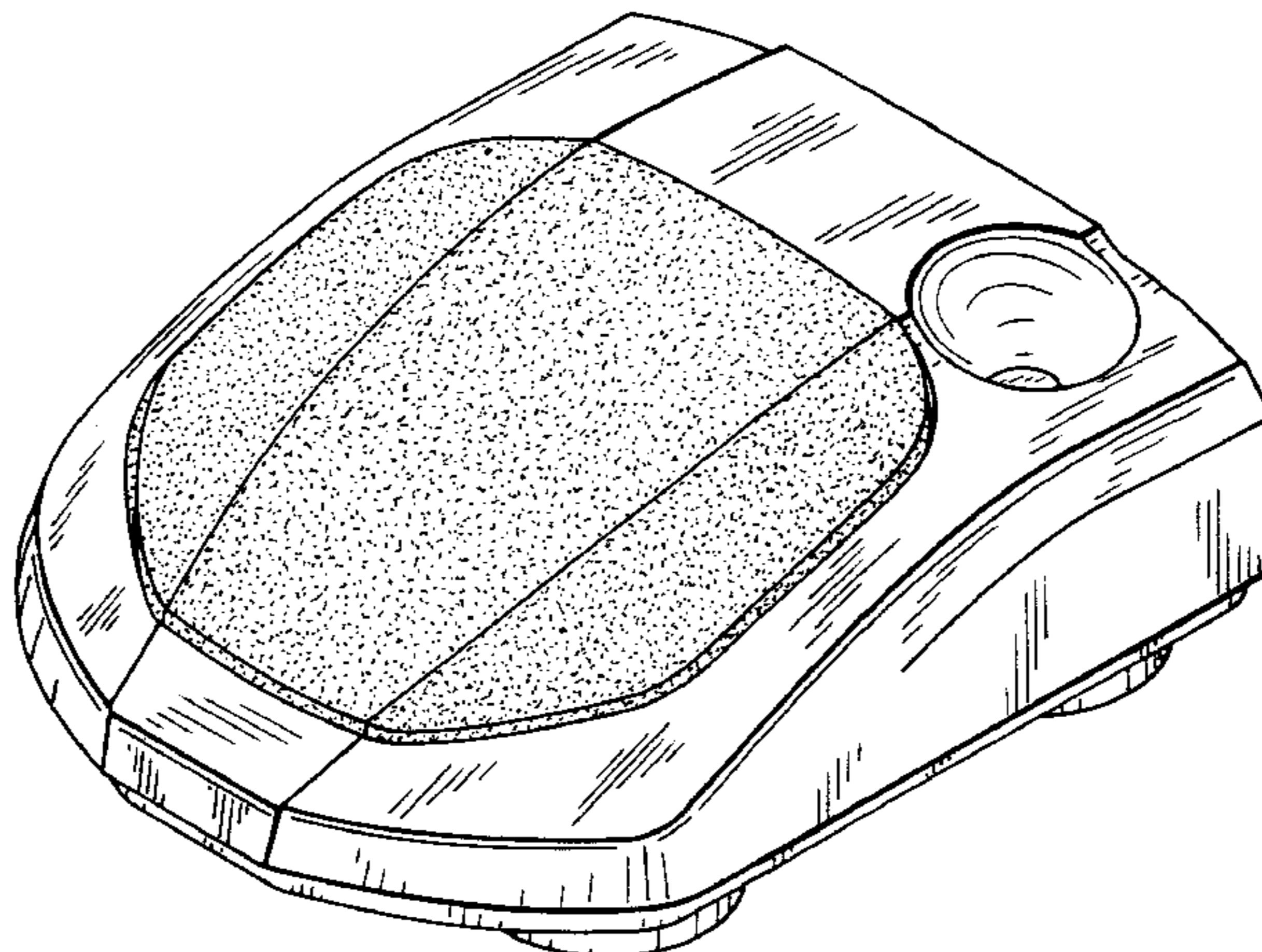
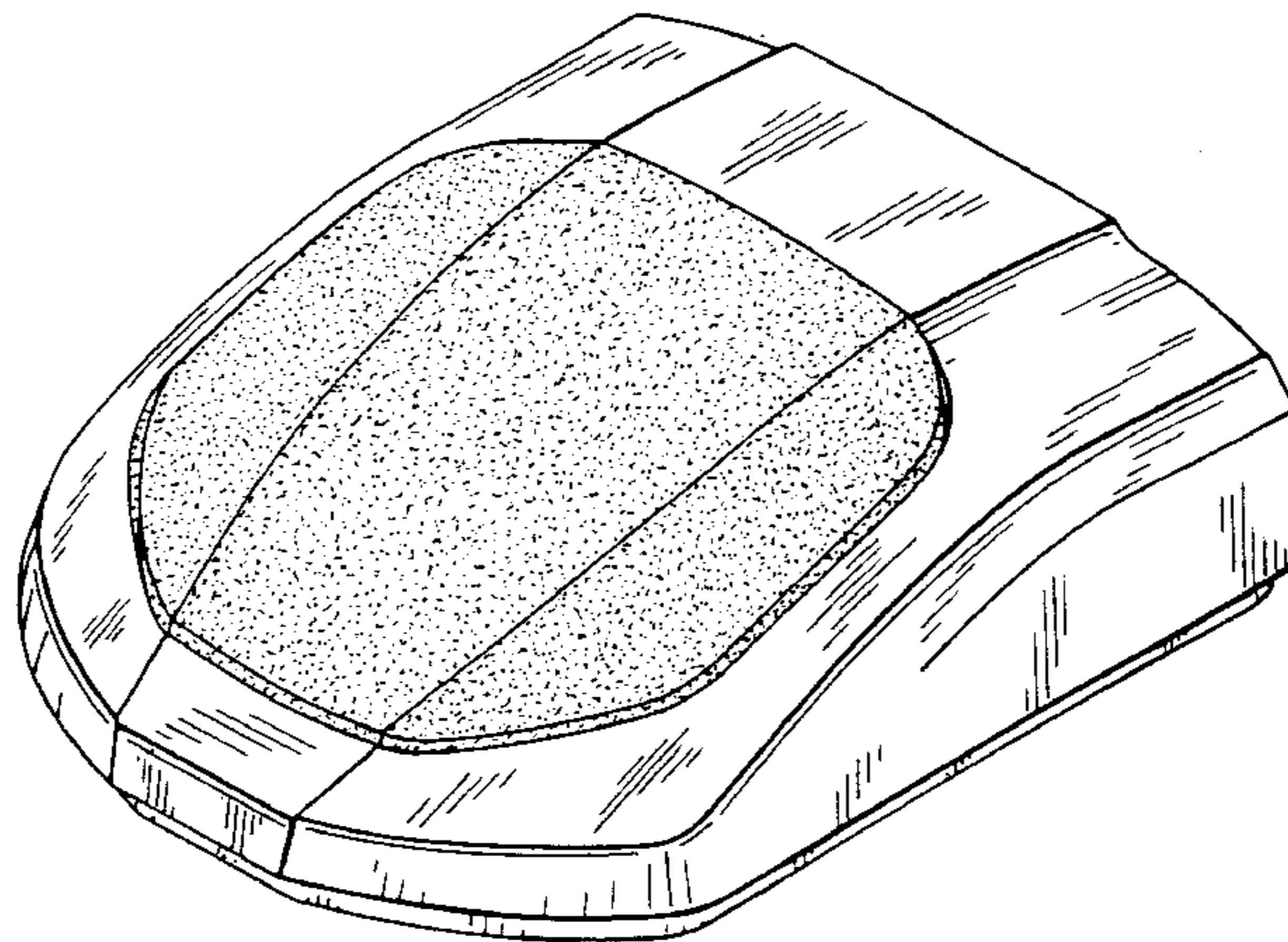

FIG. 1

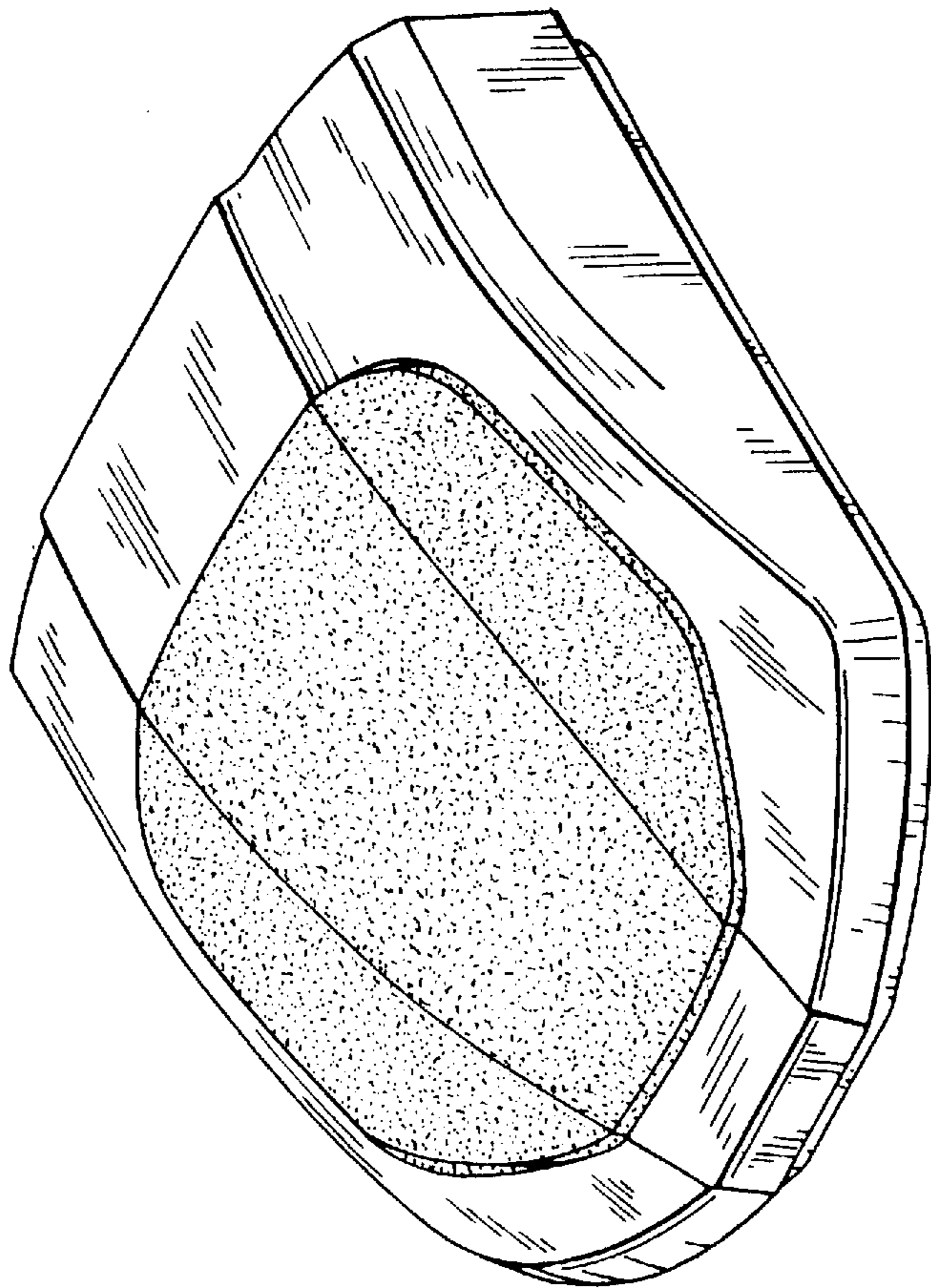

FIG. 2

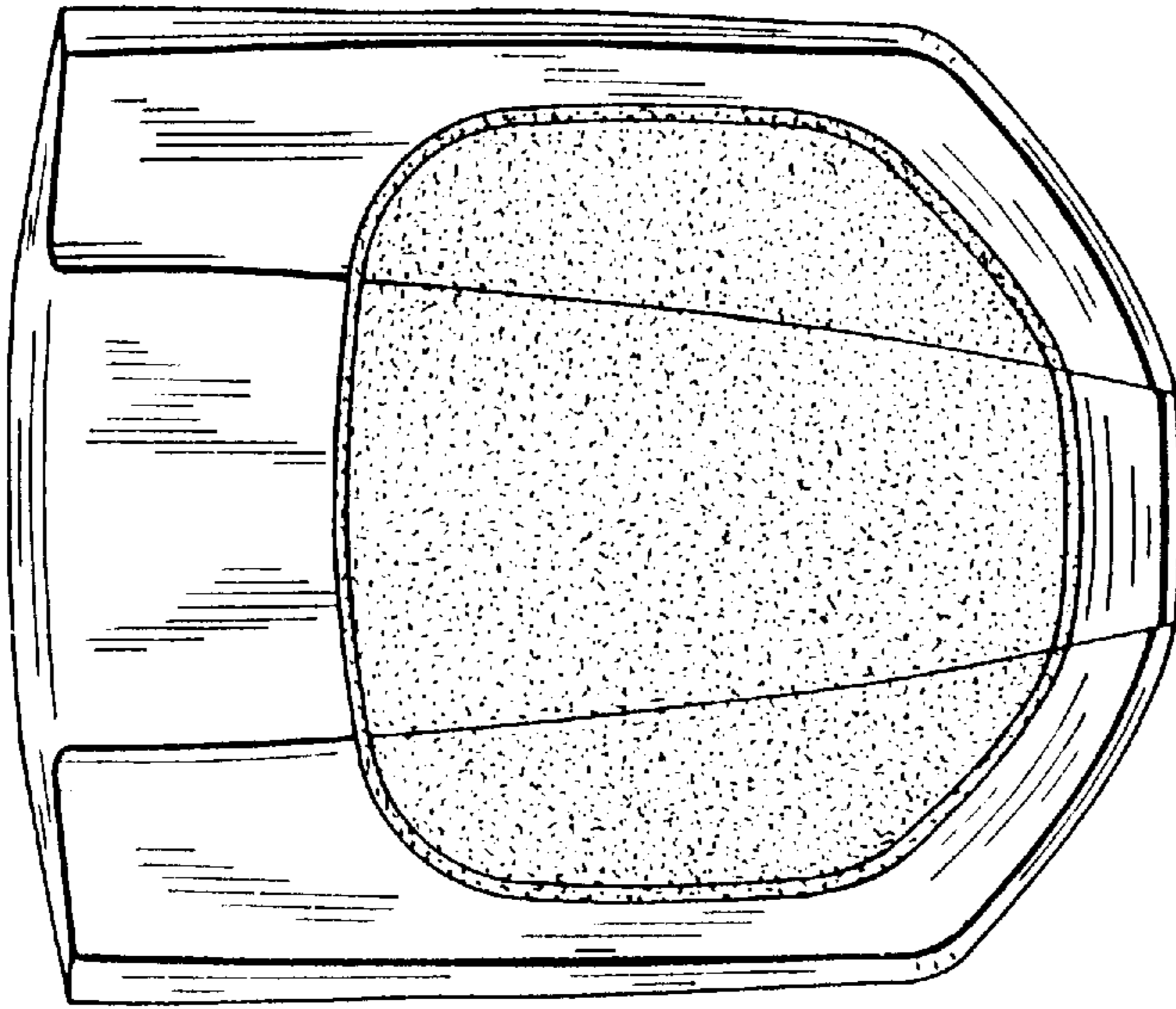

FIG. 4

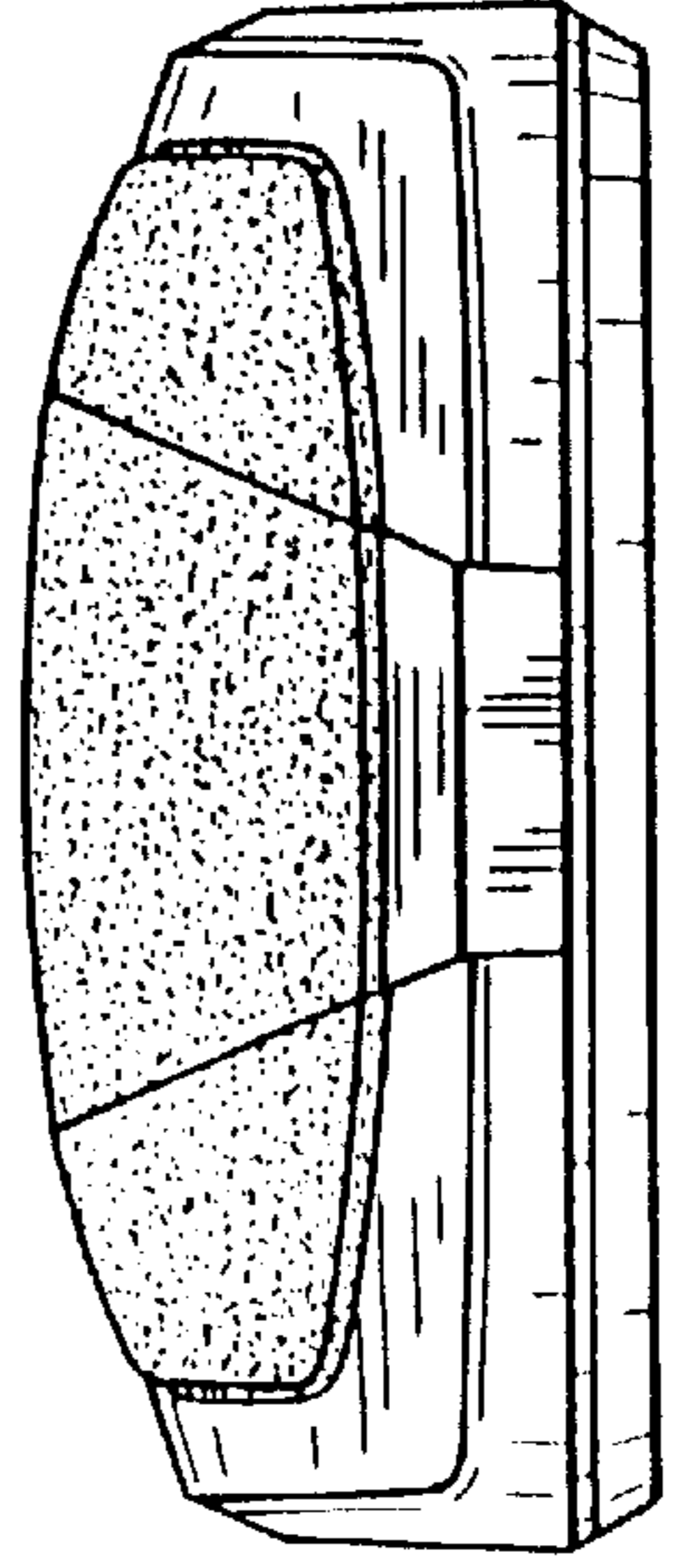

FIG. 3

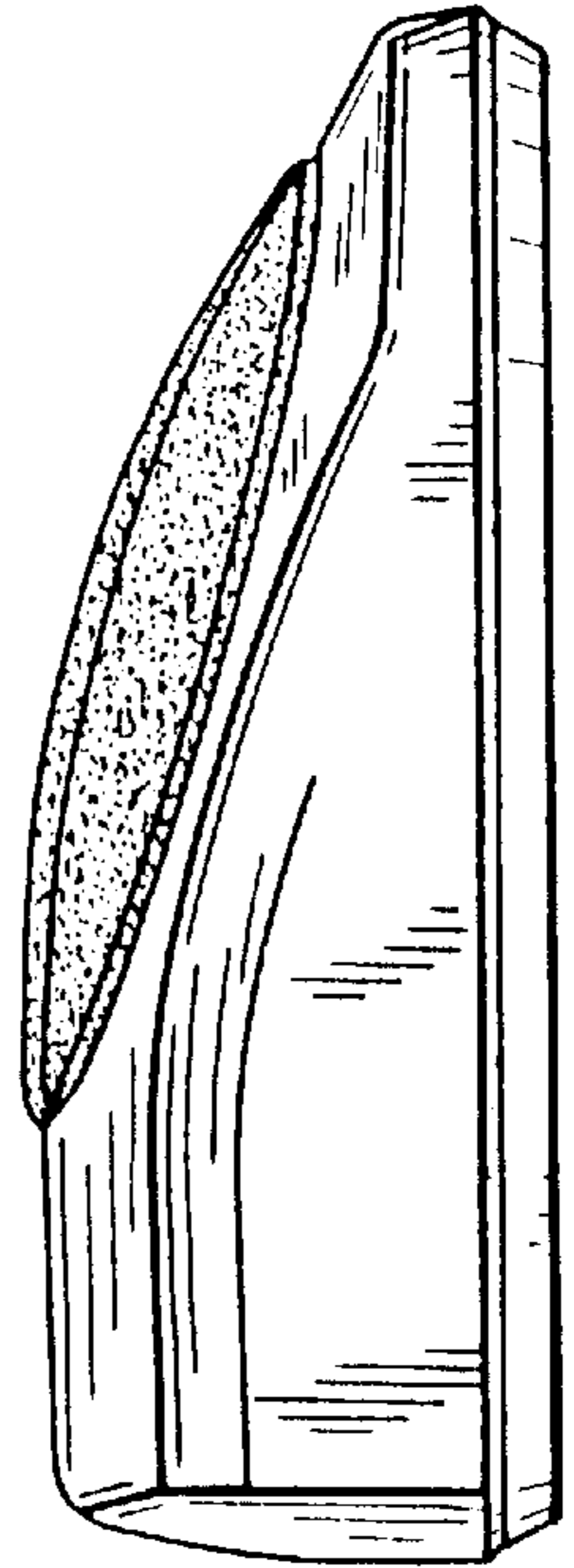

FIG. 5

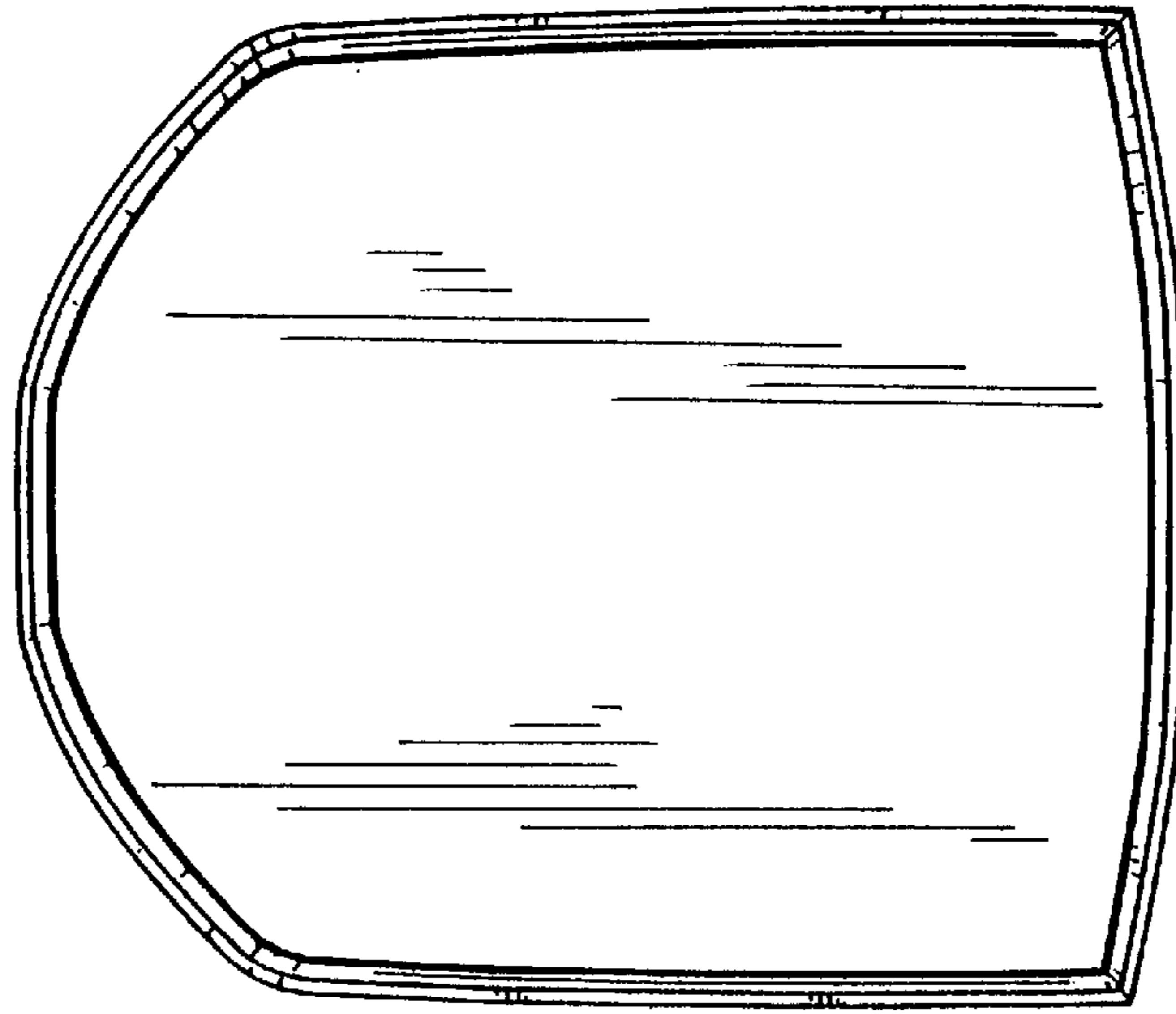

FIG. 6

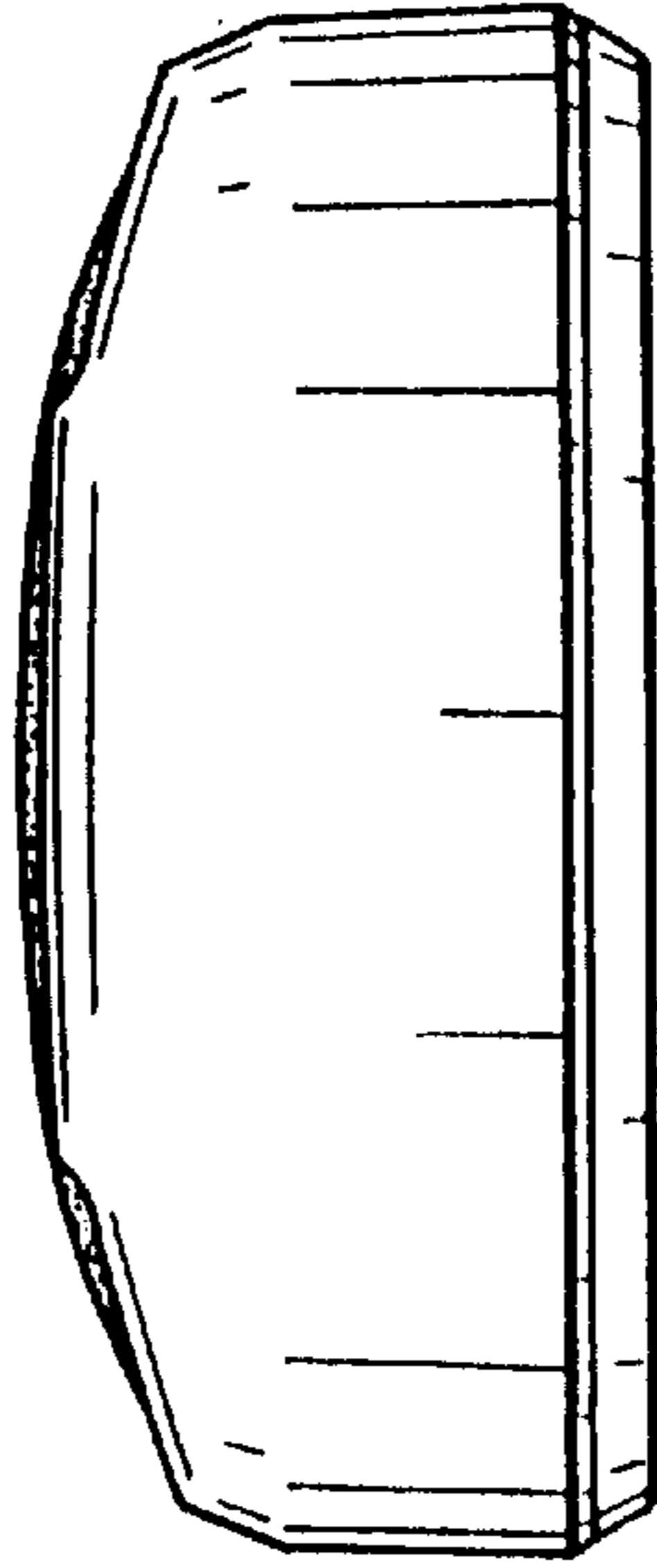

FIG. 7

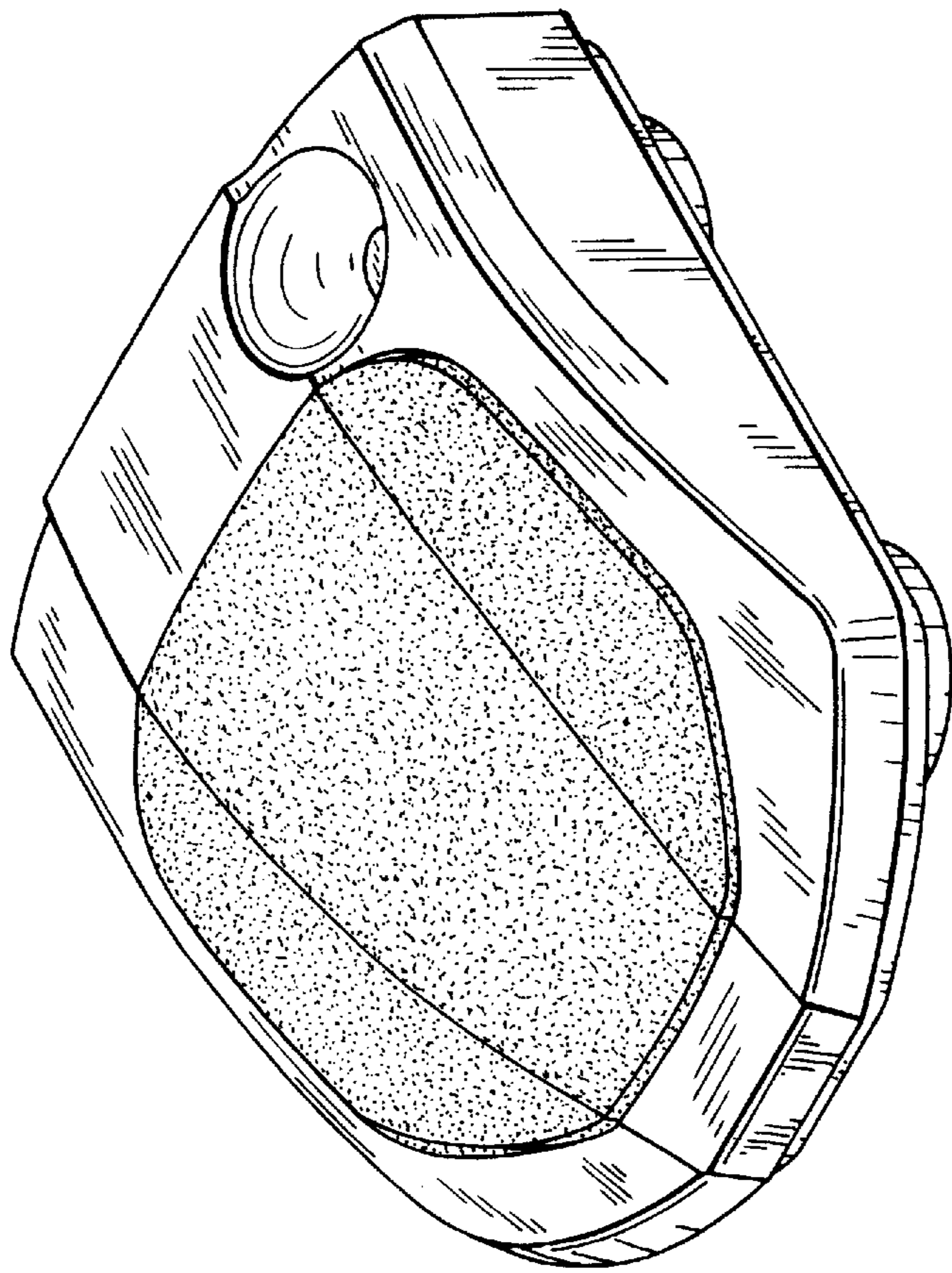

FIG. 8

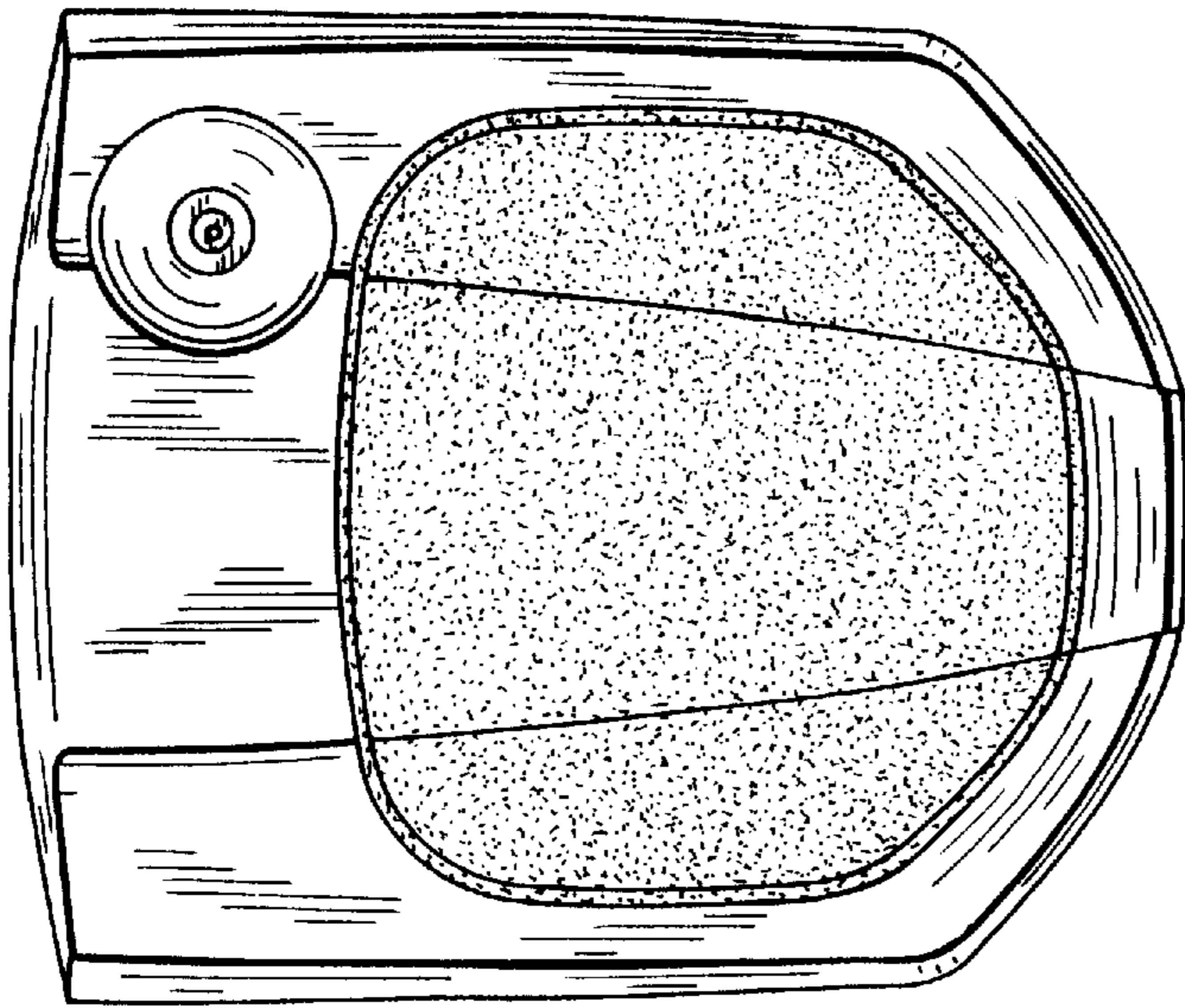

FIG. 10

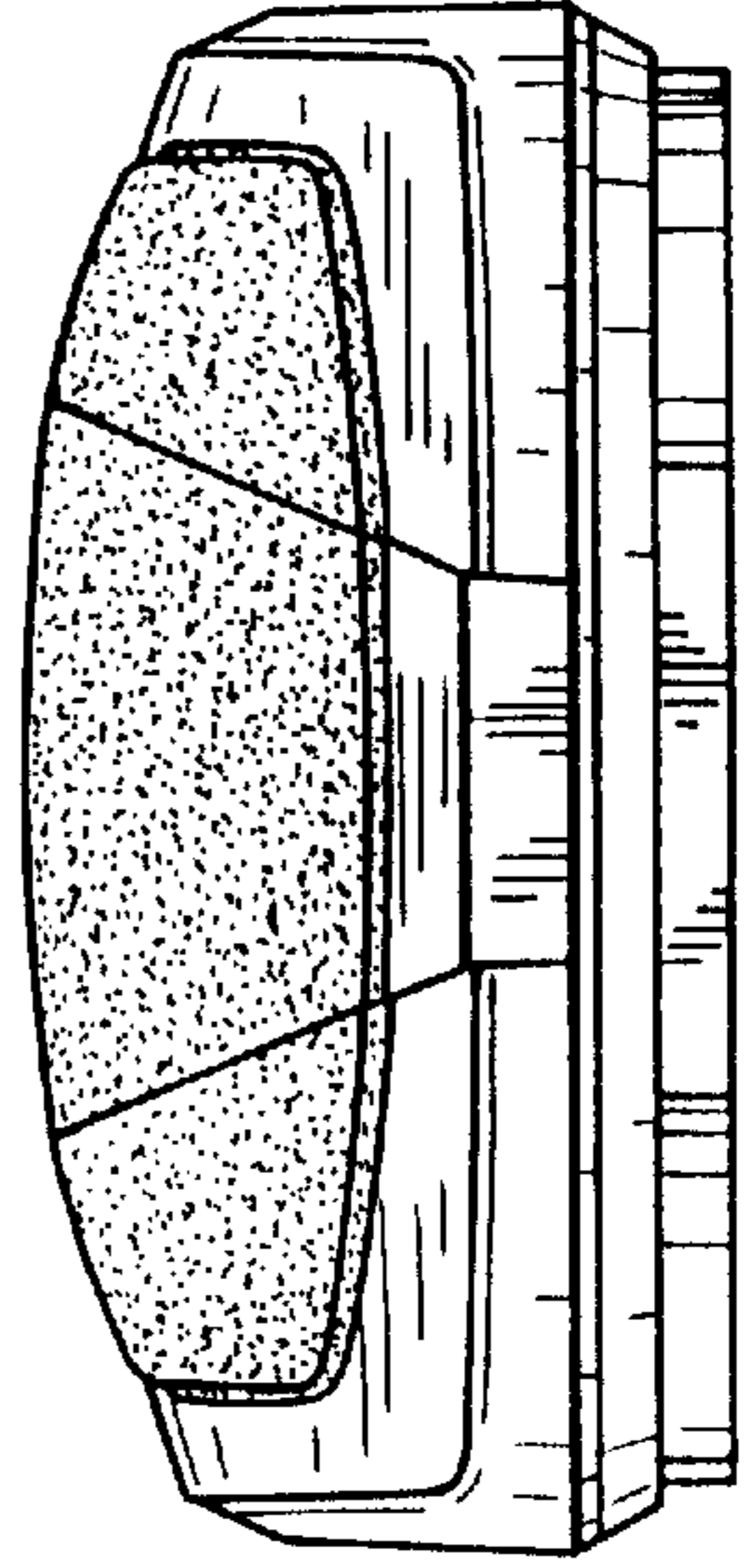

FIG. 9

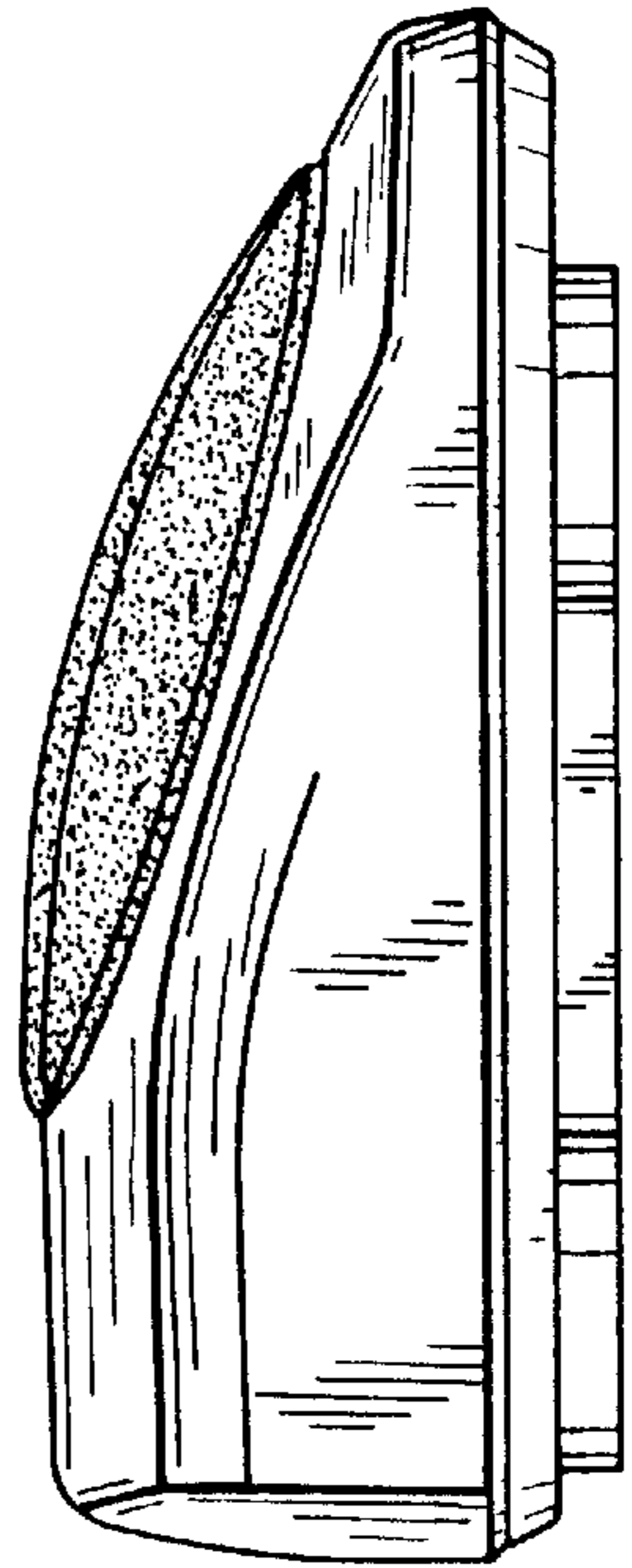

FIG. 11

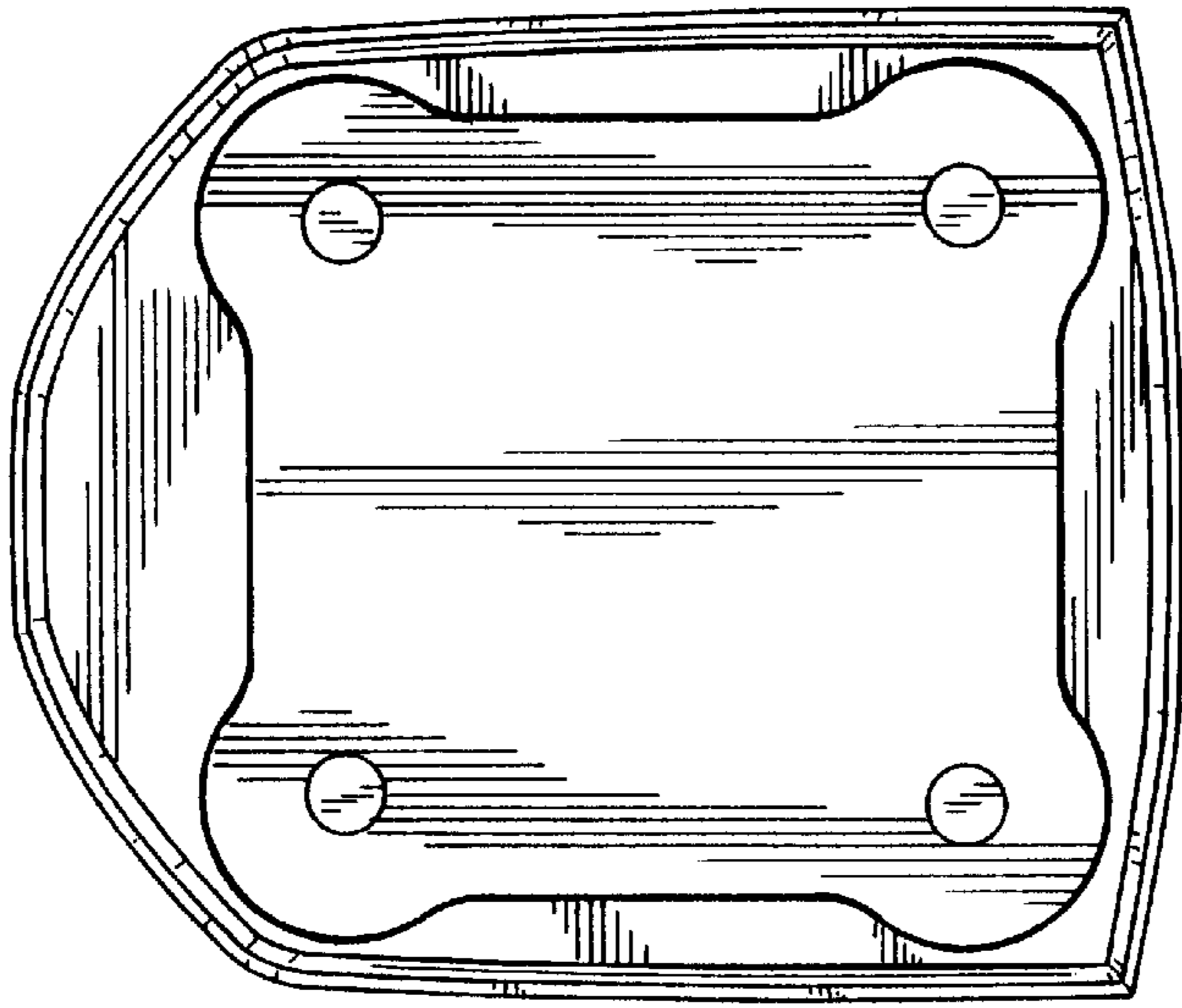

FIG. 13

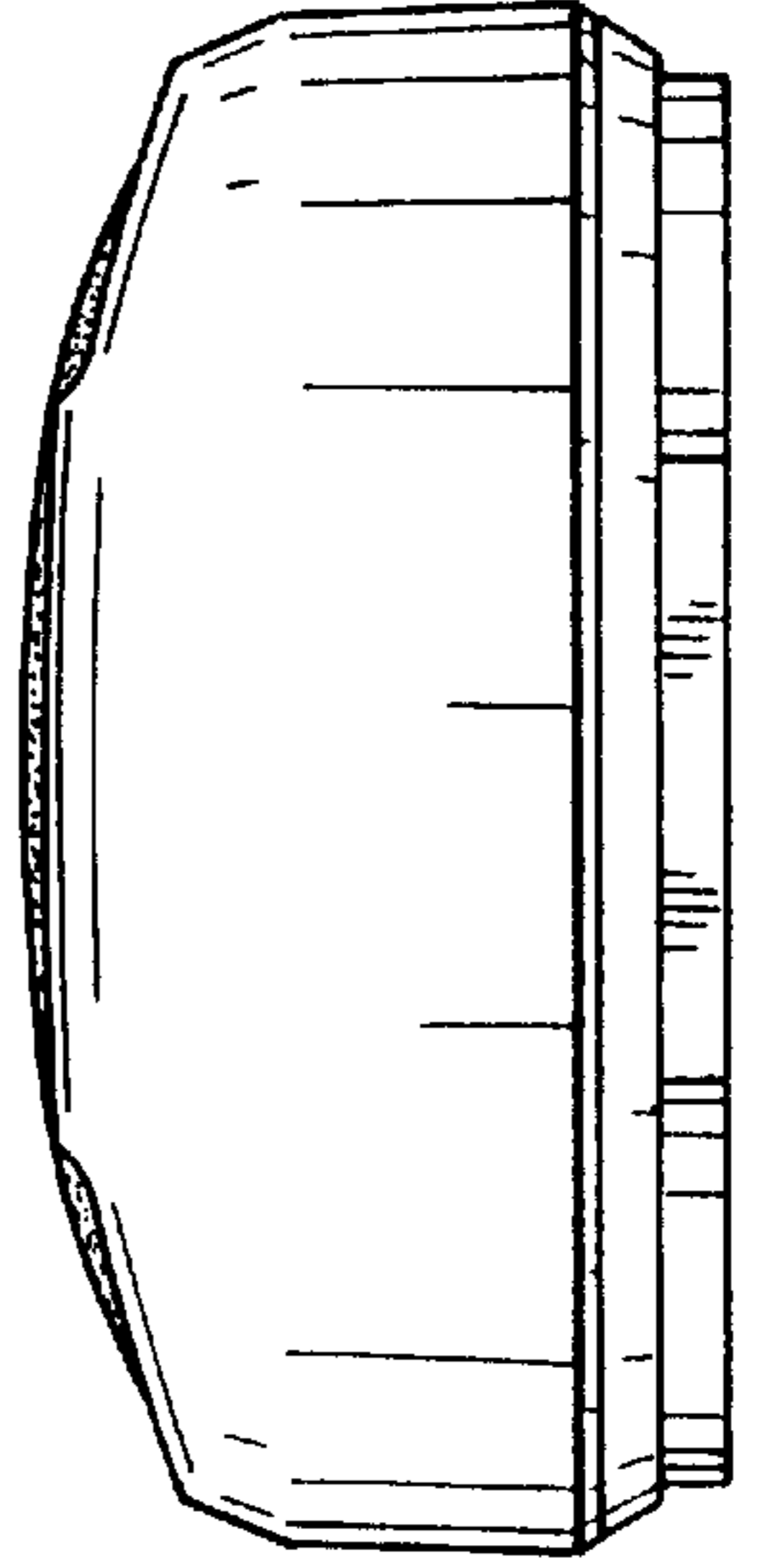

FIG. 12

