



US00D402526S

United States Patent [19]

Mahlmann et al.

[11] Patent Number: Des. 402,526

[45] Date of Patent: **Dec. 15, 1998

[54] **COMBINED HANDLE AND ESCUTCHEON FOR DOORS OR WINDOWS**

[75] Inventors: **Veit Mahlmann; Sebastian Beck**, both of Hamburg, Germany

[73] Assignee: **HEWI Heinrich Wilke GmbH**, Bad Arolsen, Germany

[**] Term: **14 Years**

[21] Appl. No.: **80,485**

[22] Filed: **Dec. 10, 1997**

Related U.S. Application Data

[62] Division of Ser. No. 59,096, Sep. 3, 1996.

Foreign Application Priority Data

Mar. 1, 1996 [DE] Germany M 96 01 944.1

[51] **LOC (6) Cl.** **08-06**

[52] **U.S. Cl.** **D8/301; D8/308; D8/352**

[58] **Field of Search** **D8/301, 302, 308, D8/352; 74/549, 519; 16/110 R; 292/357; 70/452**

References Cited

U.S. PATENT DOCUMENTS

D. 317,706 6/1991 Boeri D8/308
D. 356,484 3/1995 Scholl D8/308
2,283,674 5/1942 Geyer .

OTHER PUBLICATIONS

Forms & Surfaces—Omni Hardware; back of brochure; lever HL93.

Ironmonger Cat; p. 37; lever and escutcheon 103–230.E ©1983.

Resina—Premar; p. 4; lever and escutcheon 5000. HEWI brochure; escutcheon p. 2.

Primary Examiner—B. J. Bullock
Attorney, Agent, or Firm—Michael J. Striker

[57] CLAIM

The ornamental design for a combined handle and escutcheon for doors or windows, as shown and described.

DESCRIPTION

FIG. 1 is a front view of a combined handle and escutcheon for doors and windows showing my new design;
FIG. 2 is a right side view thereof;
FIG. 3 is a left side view thereof;
FIG. 4 is a plan view thereof;
FIG. 5 is a bottom view thereof;
FIG. 6 is a perspective view thereof;
FIG. 7 is a front view of an alternate embodiment of my new design;
FIG. 8 is a right side view thereof;
FIG. 9 is a left side view thereof;
FIG. 10 is a plan view thereof;
FIG. 11 is a bottom view thereof;
FIG. 12 is a perspective view thereof;
FIG. 13 is a front view of an alternate embodiment of my new design;
FIG. 14 is a left side view thereof;
FIG. 15 is a right side view thereof;
FIG. 16 is a plan view thereof;
FIG. 17 is a bottom view thereof; and,
FIG. 18 is a perspective view thereof.

1 Claim, 6 Drawing Sheets

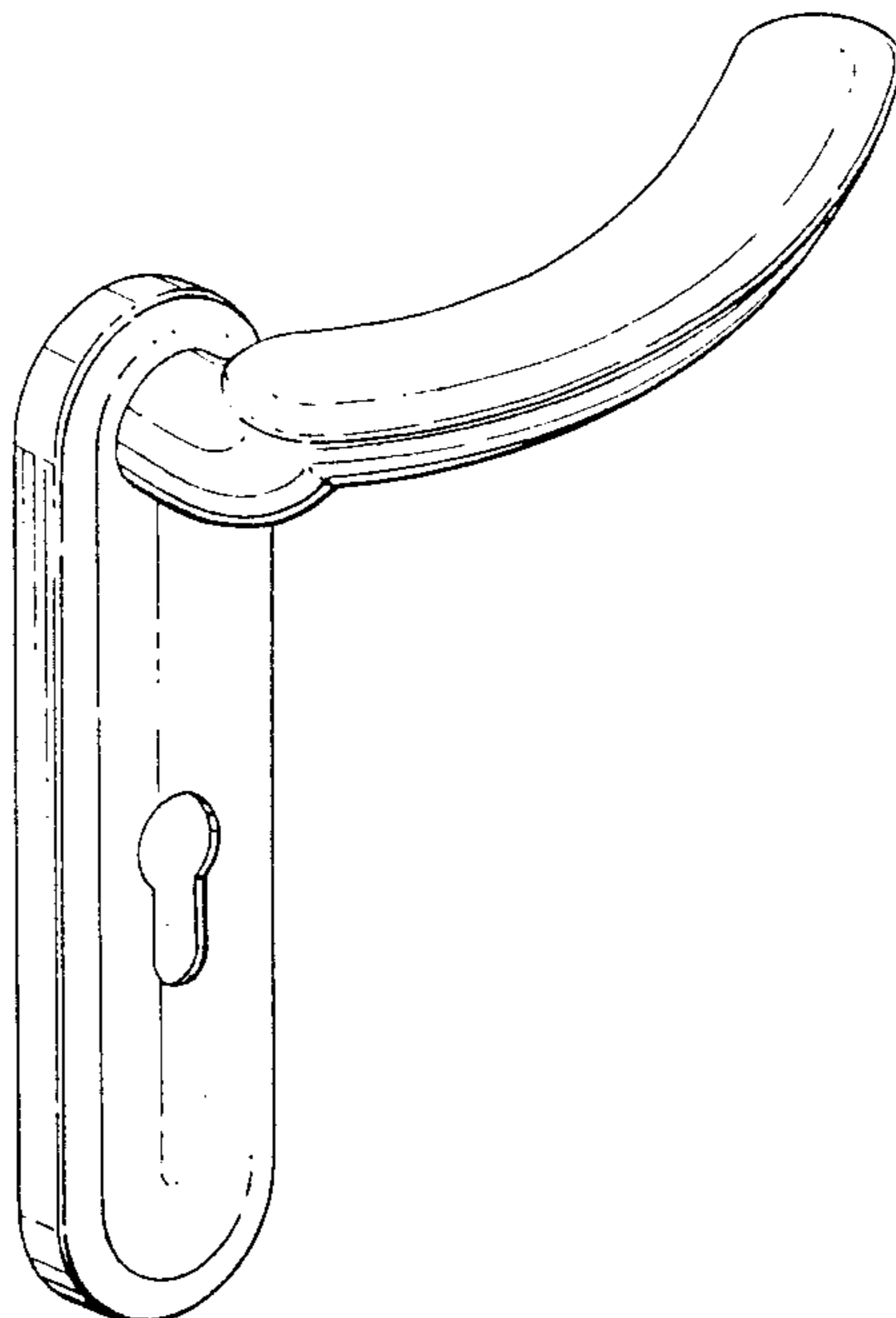

Fig.1.

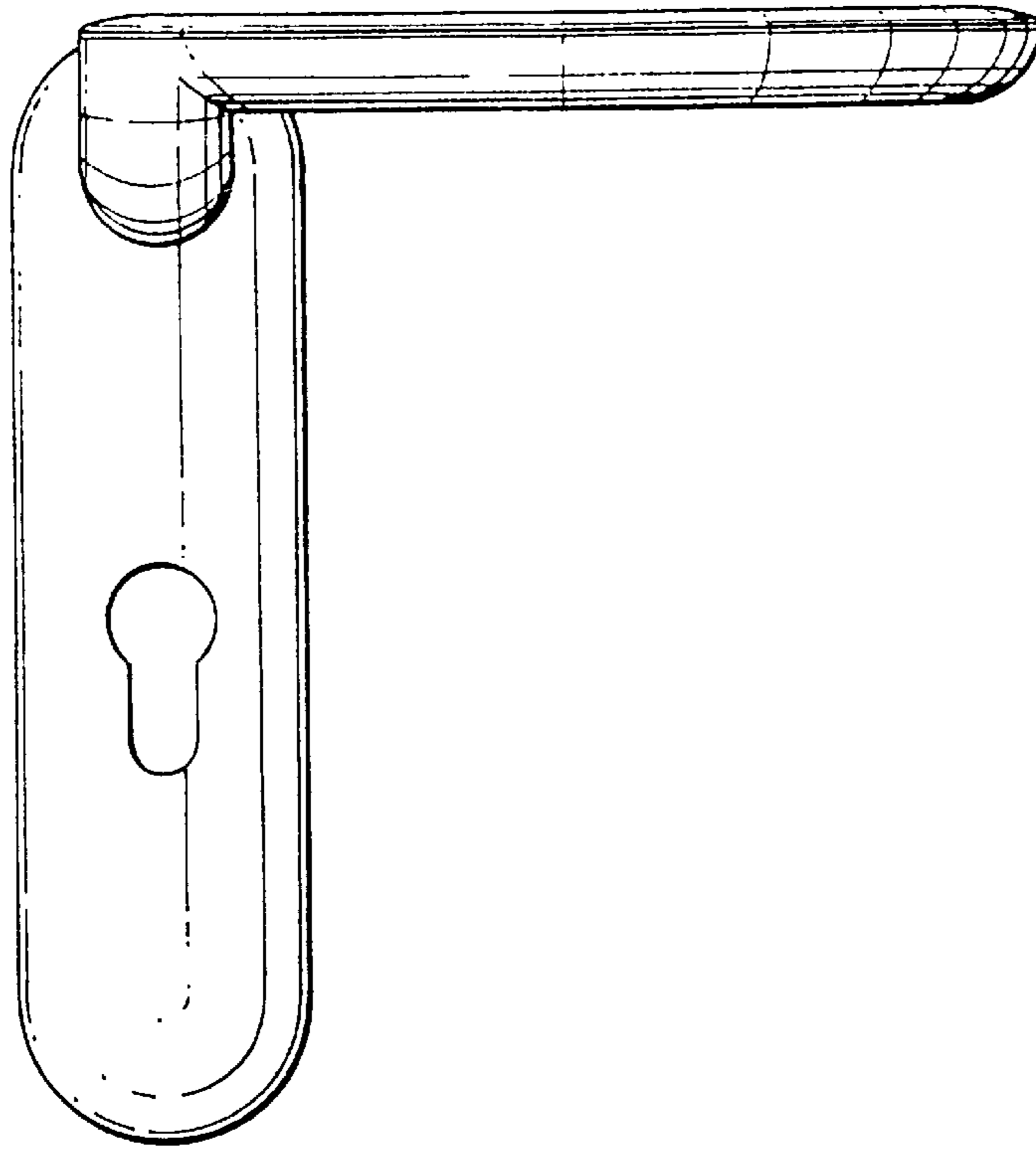

Fig.3.

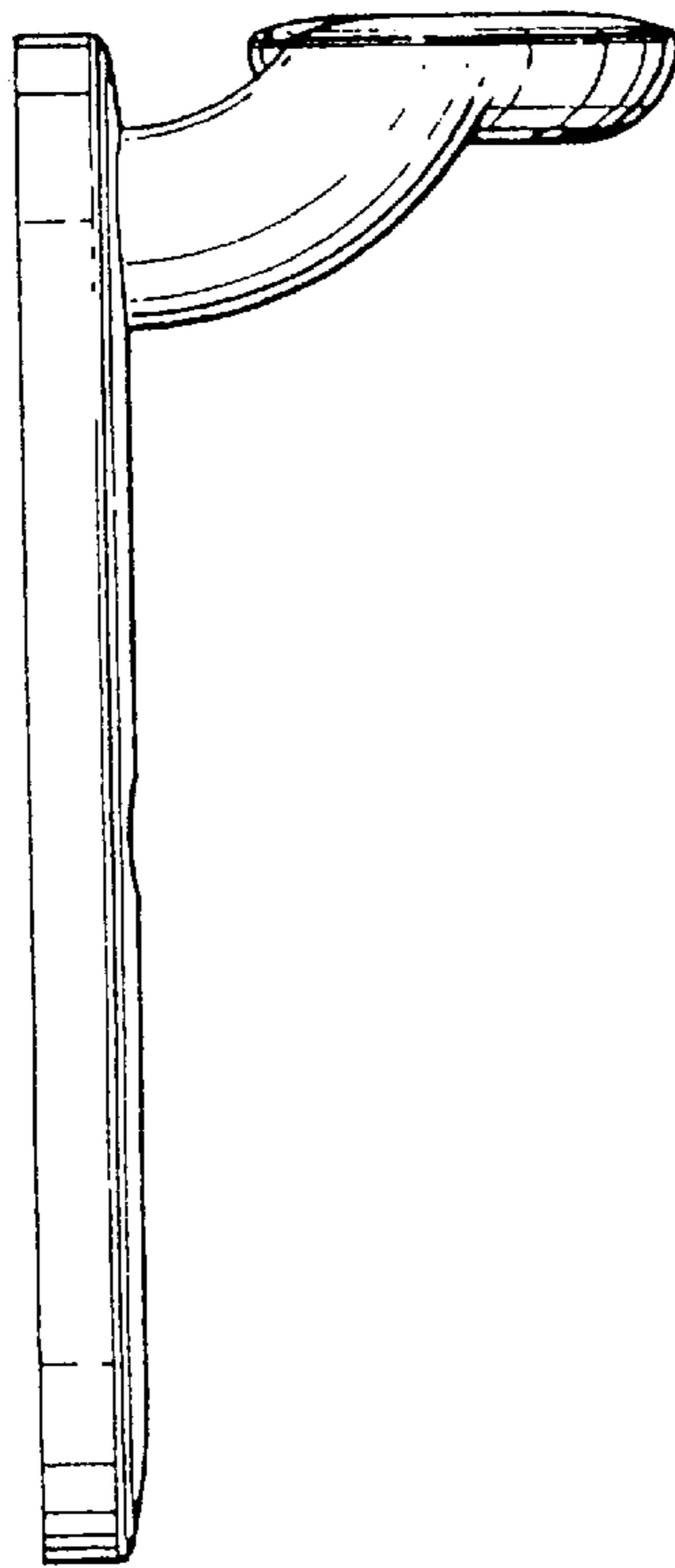

Fig.2.

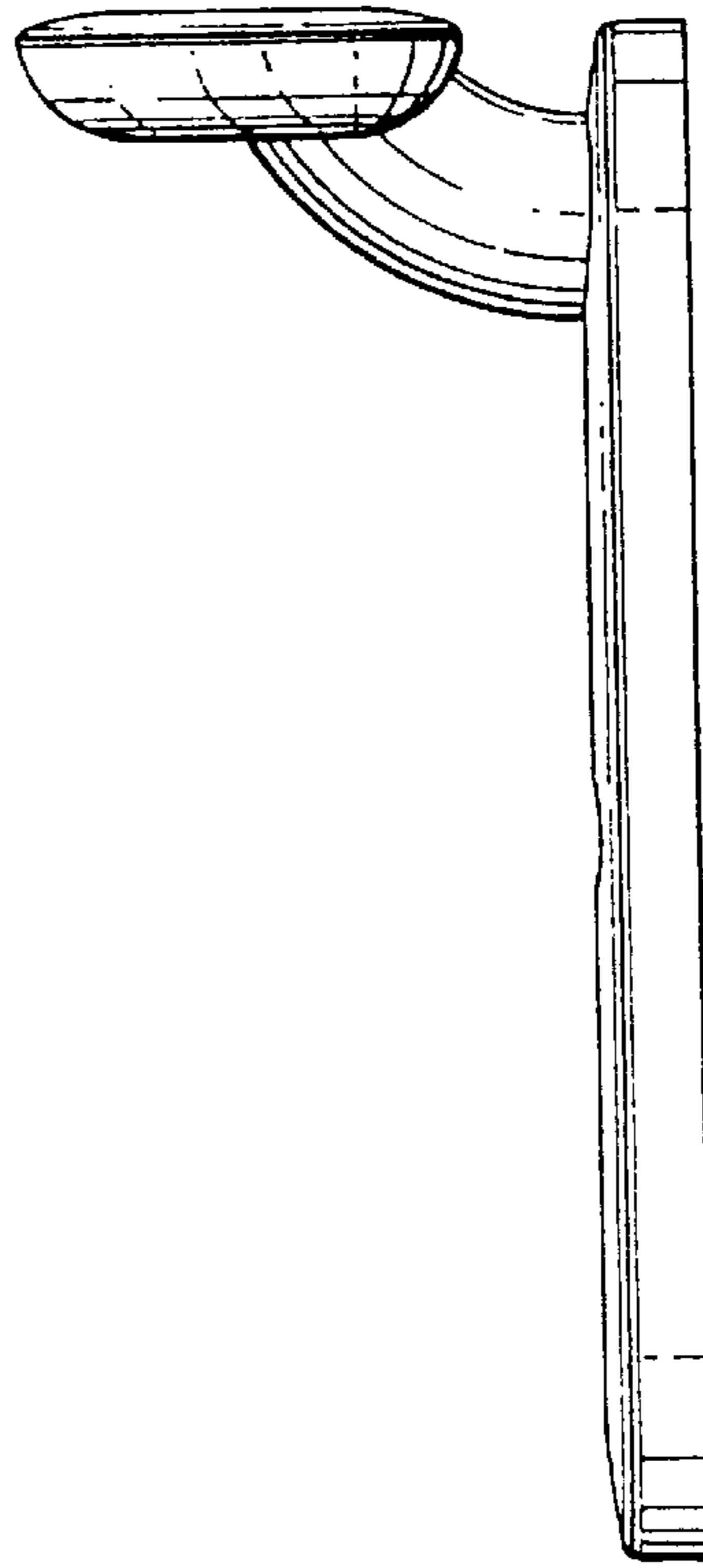

Fig.6.

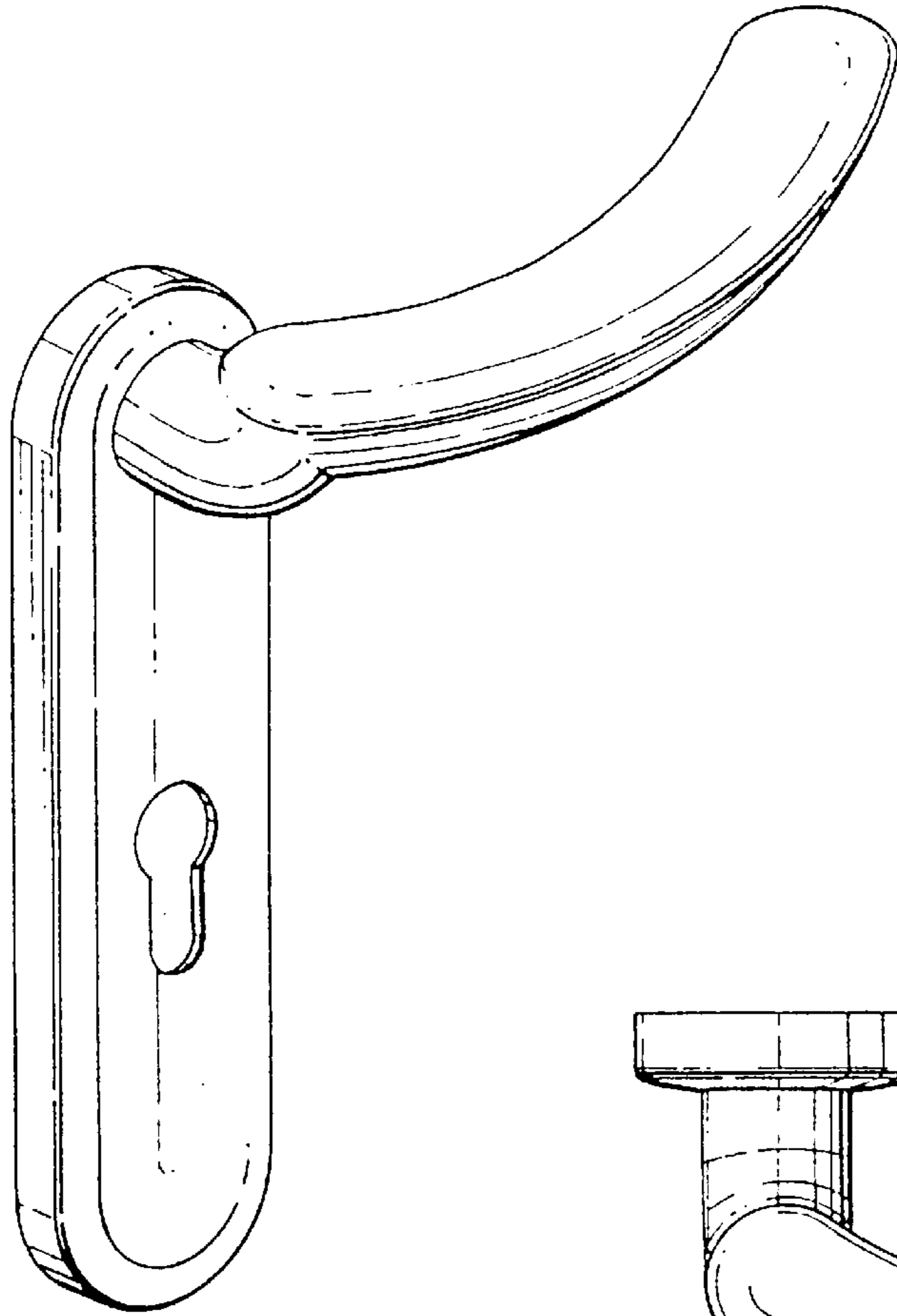

Fig.4.

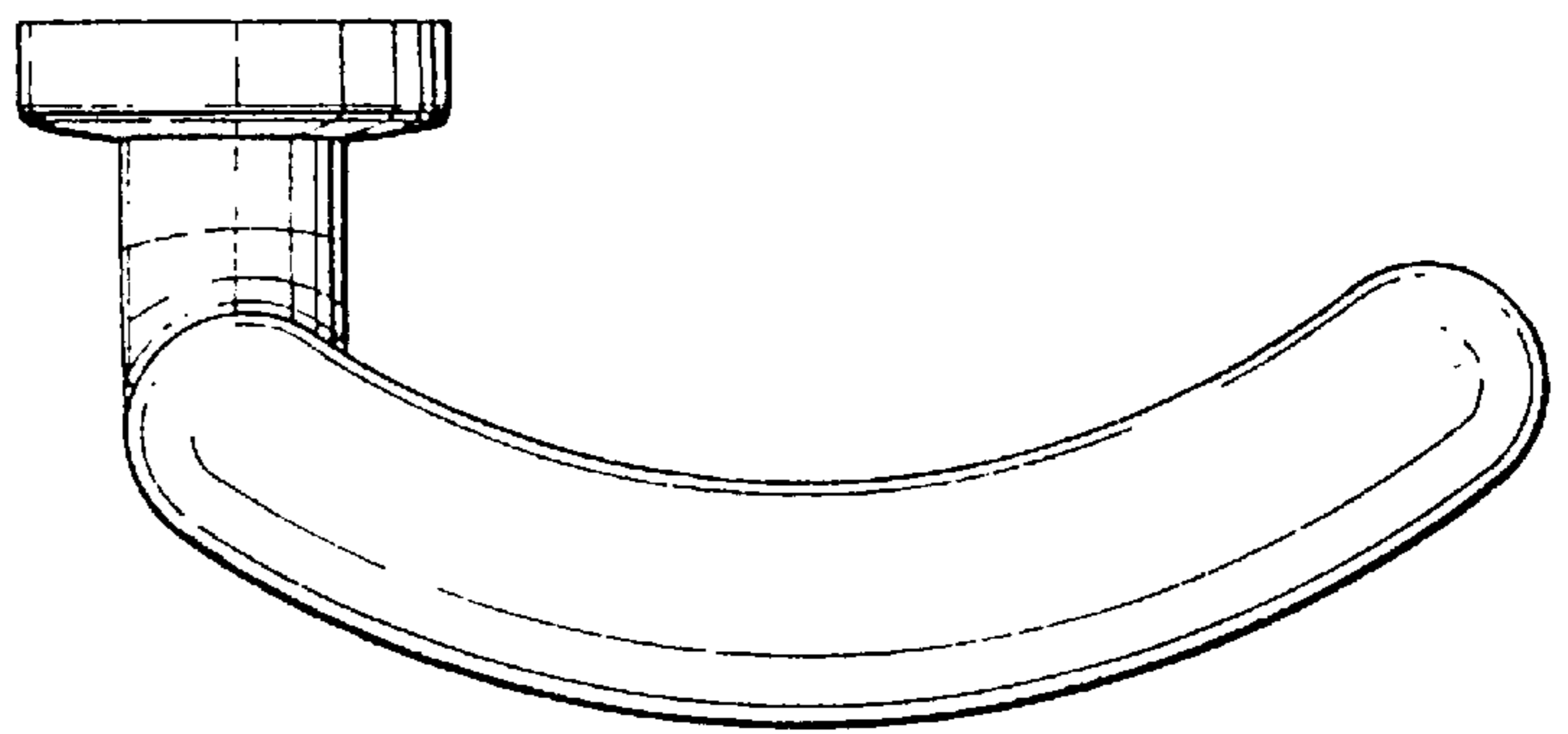
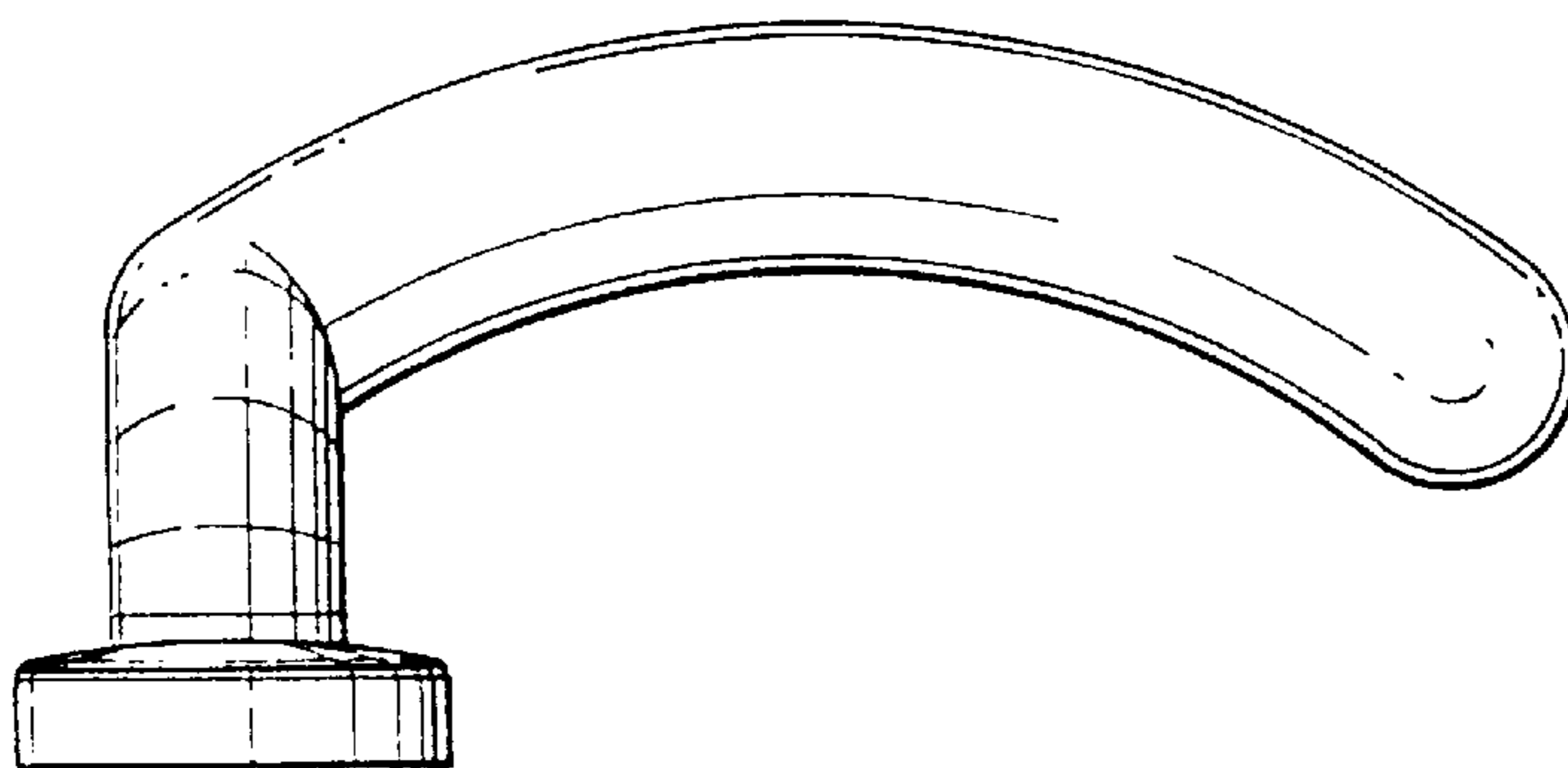

Fig.5.



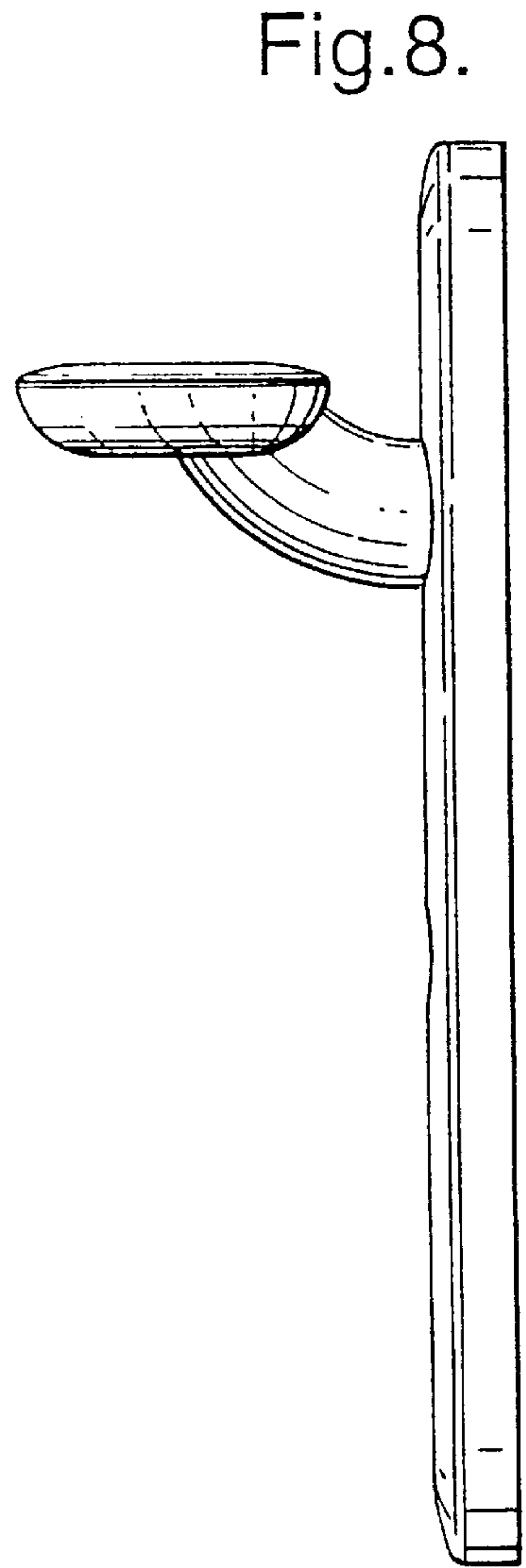
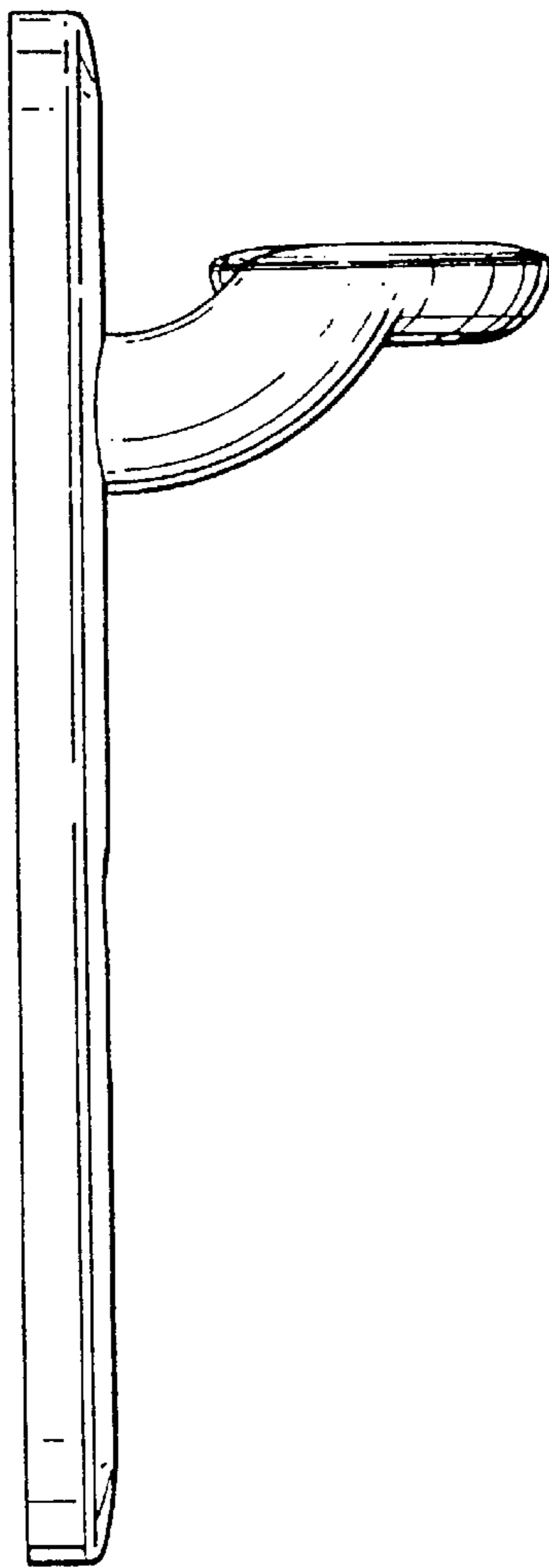
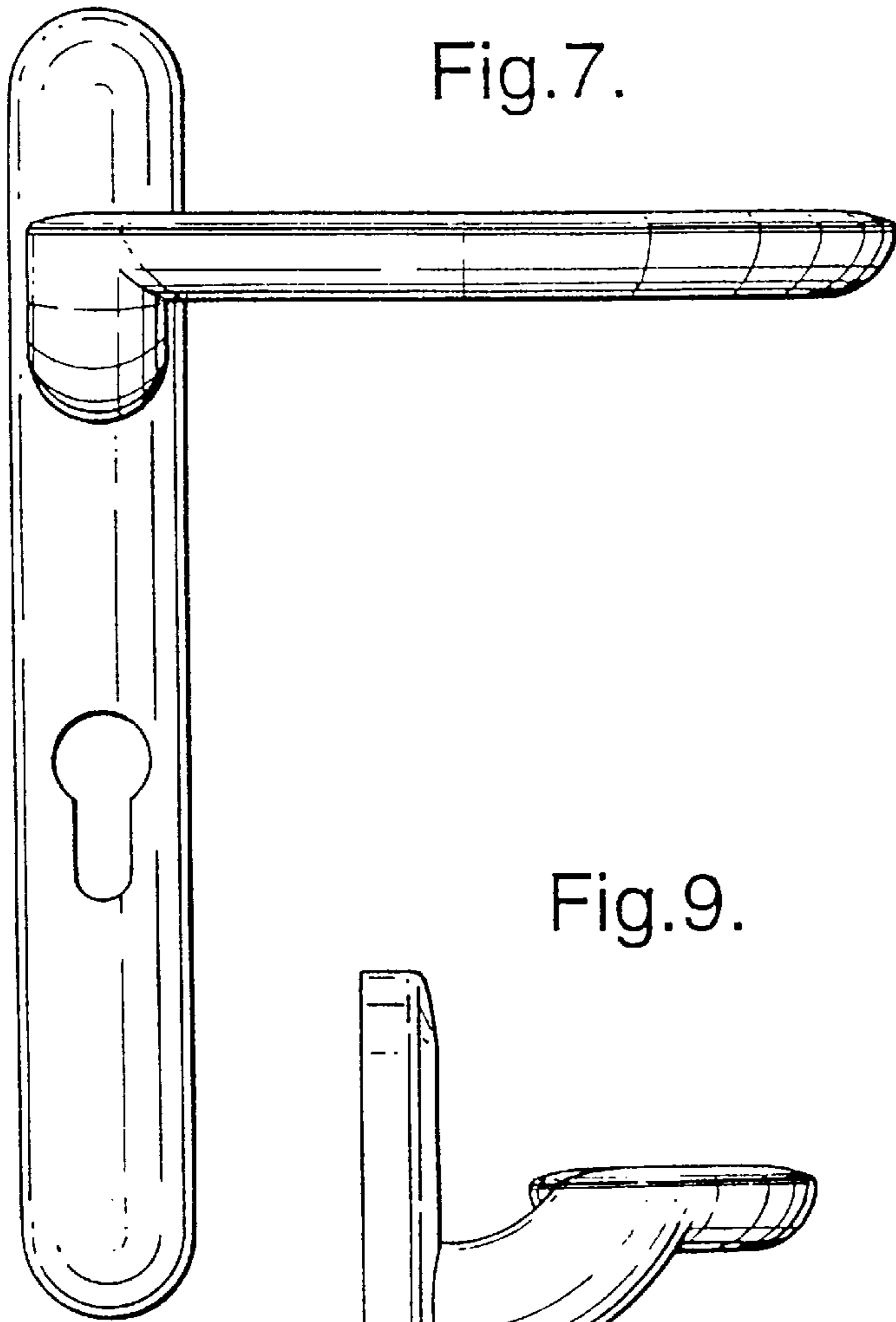

Fig.12.

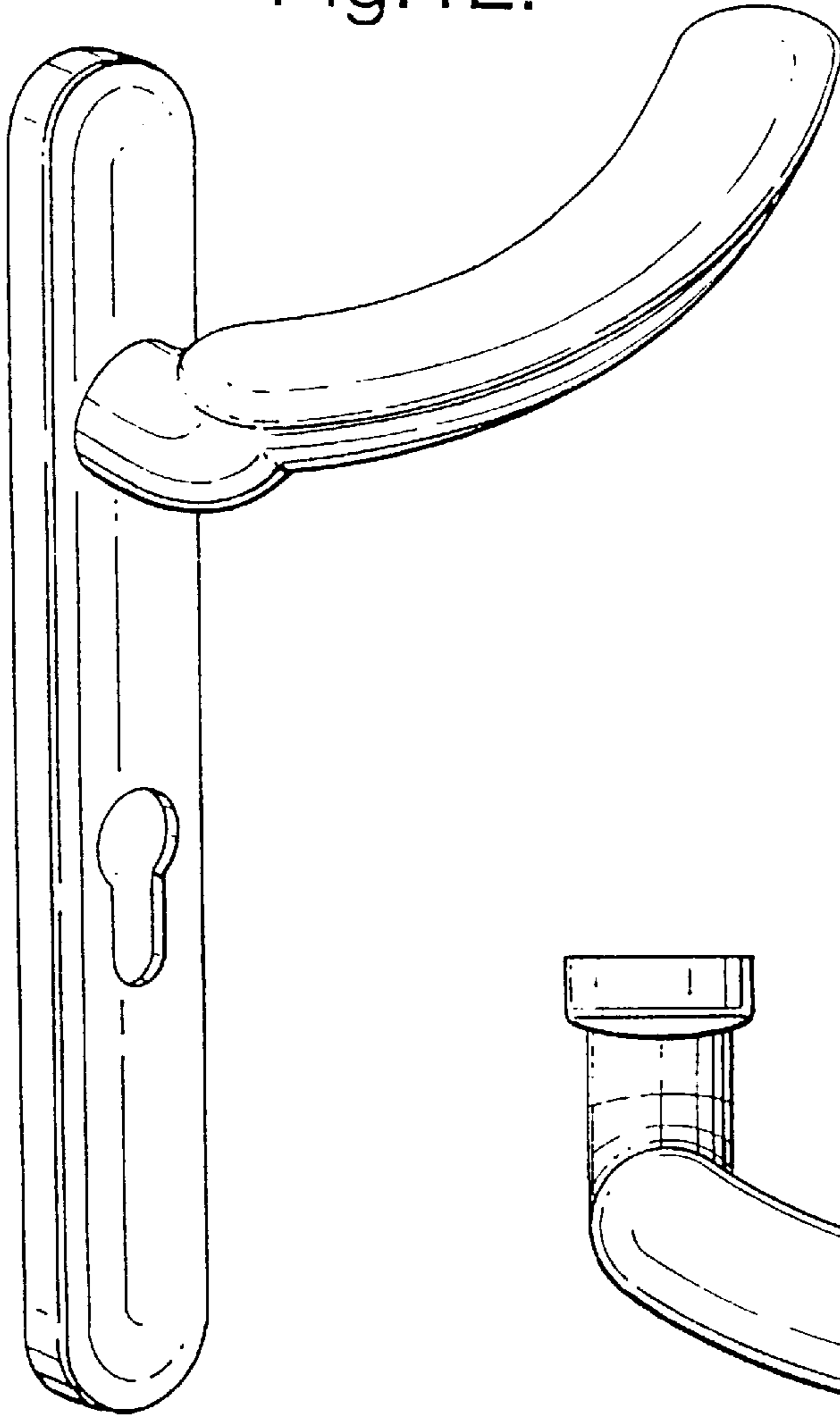

Fig.10.

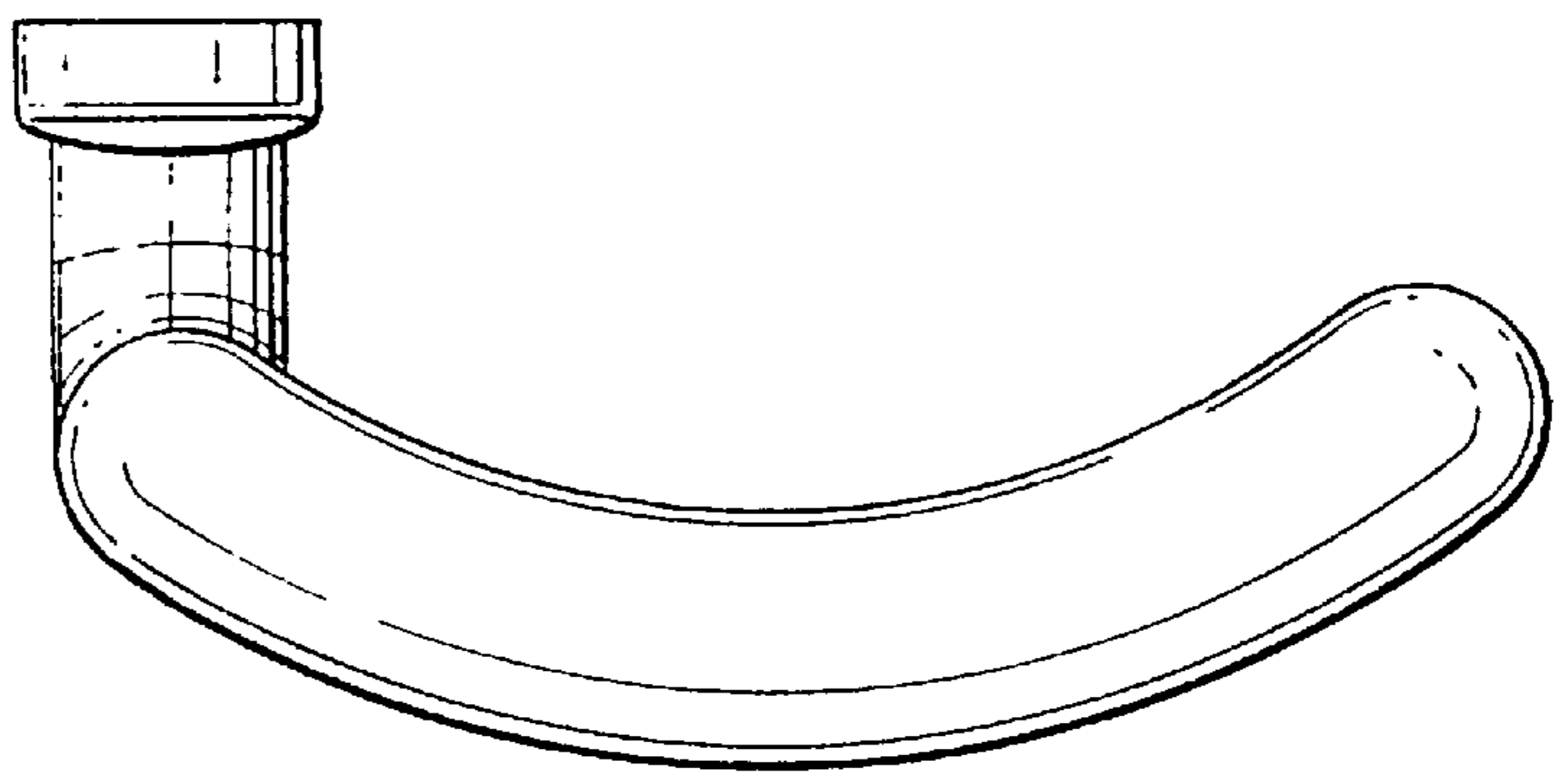

Fig.11.

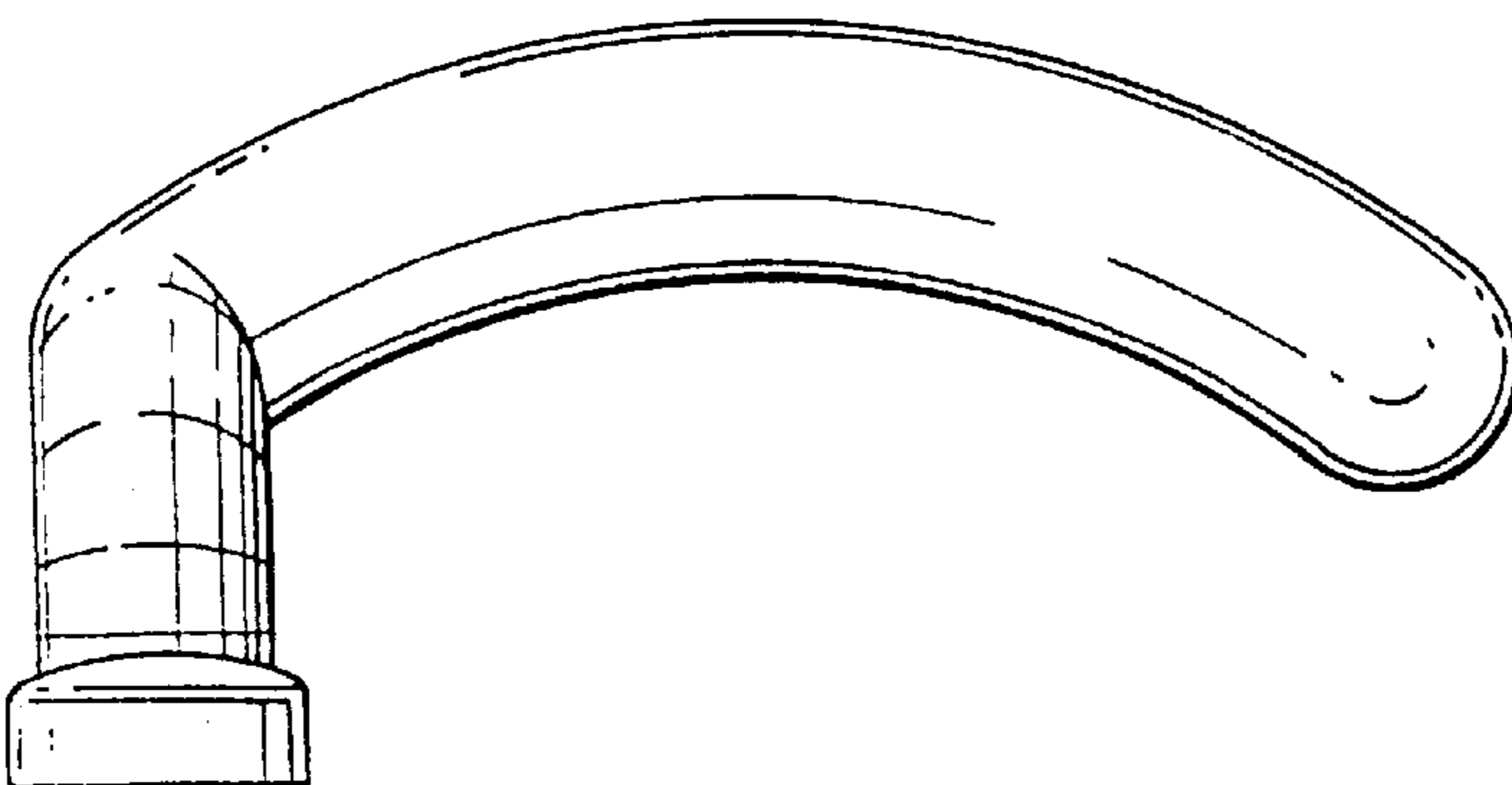

Fig.13.

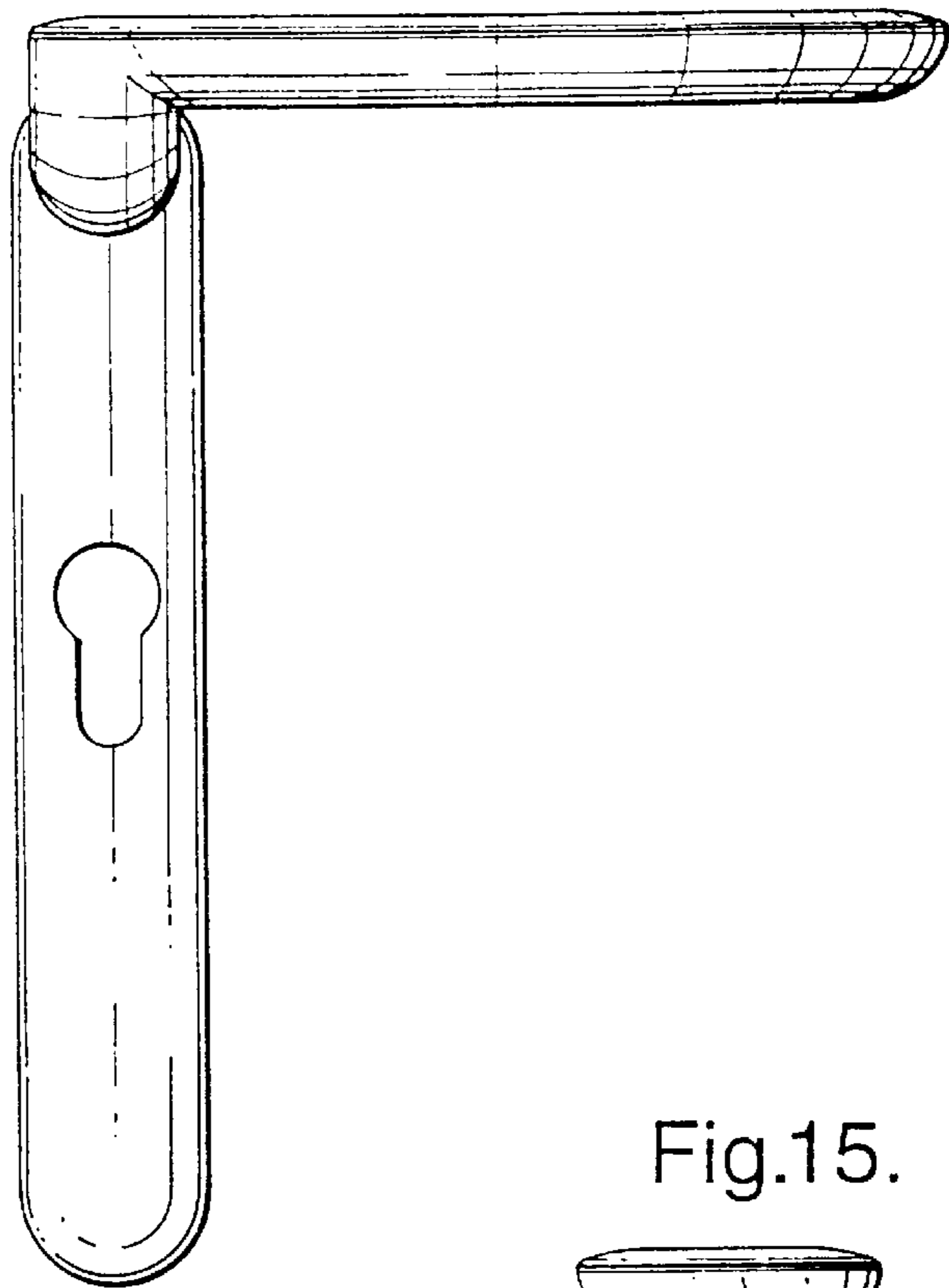

Fig.14.

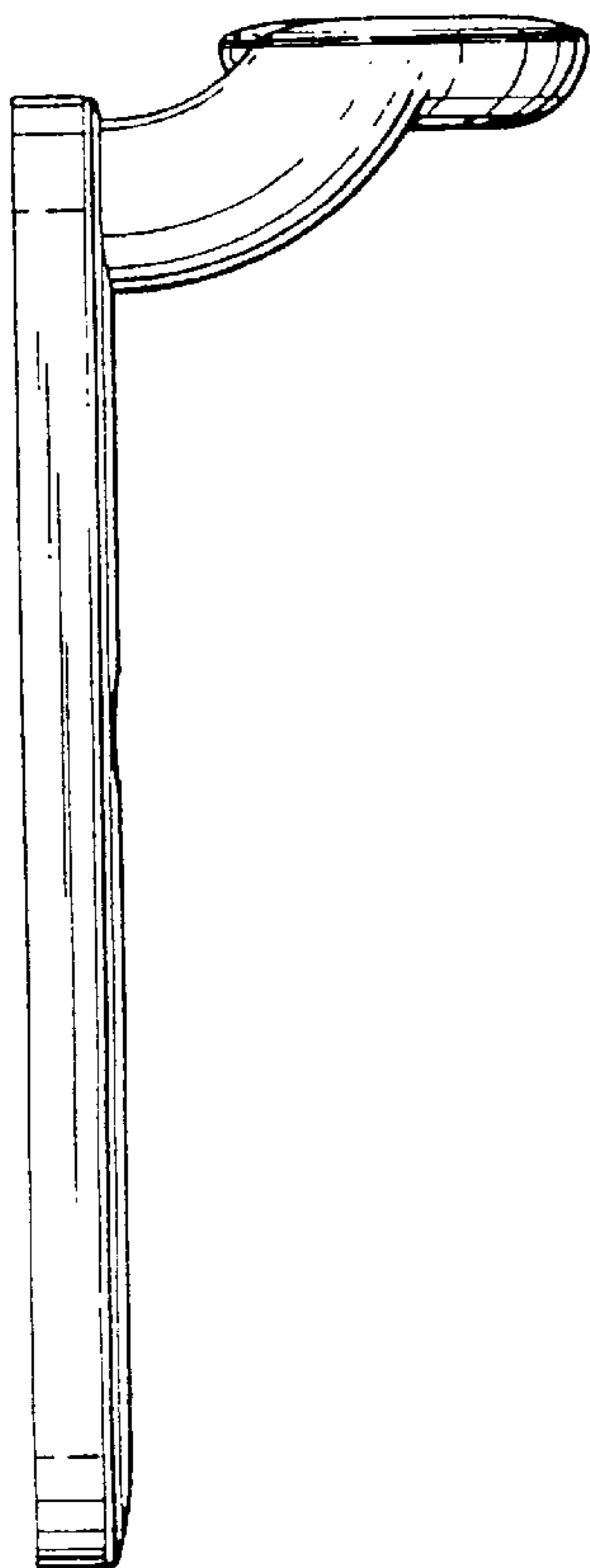

Fig.15.

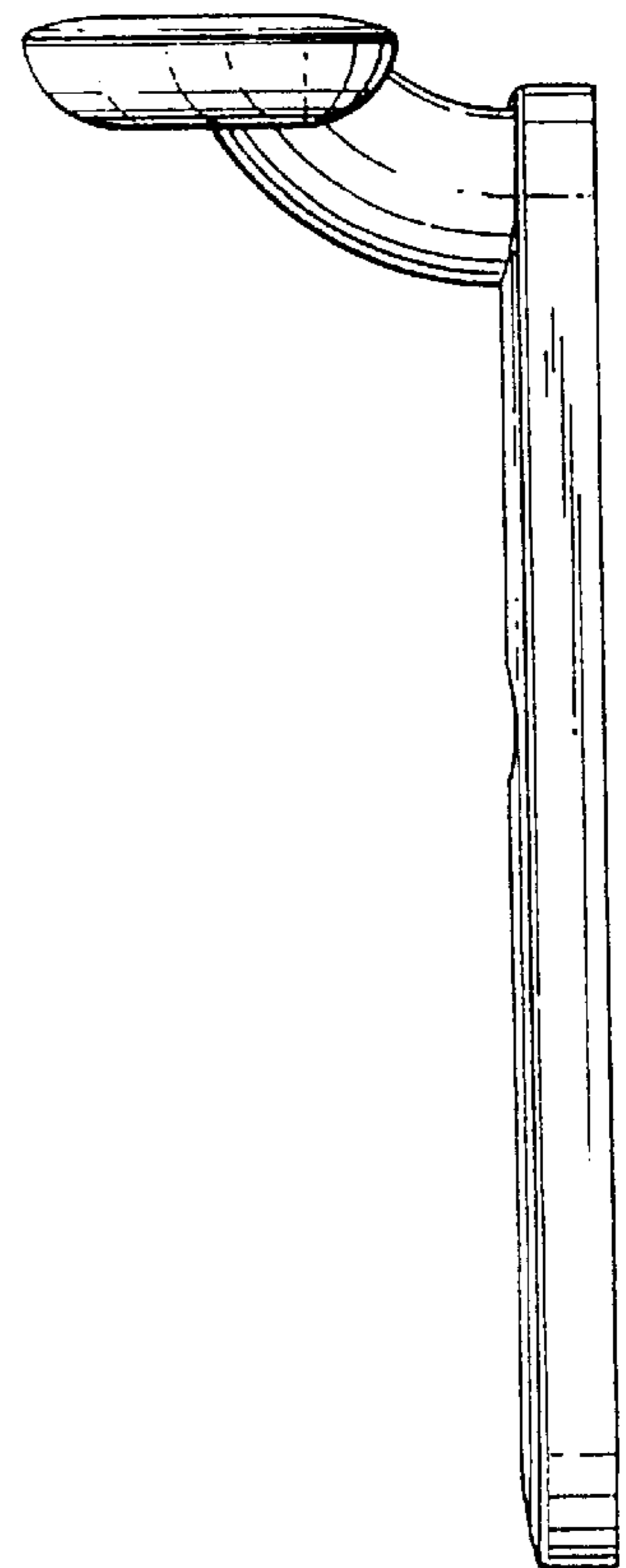

Fig.18.

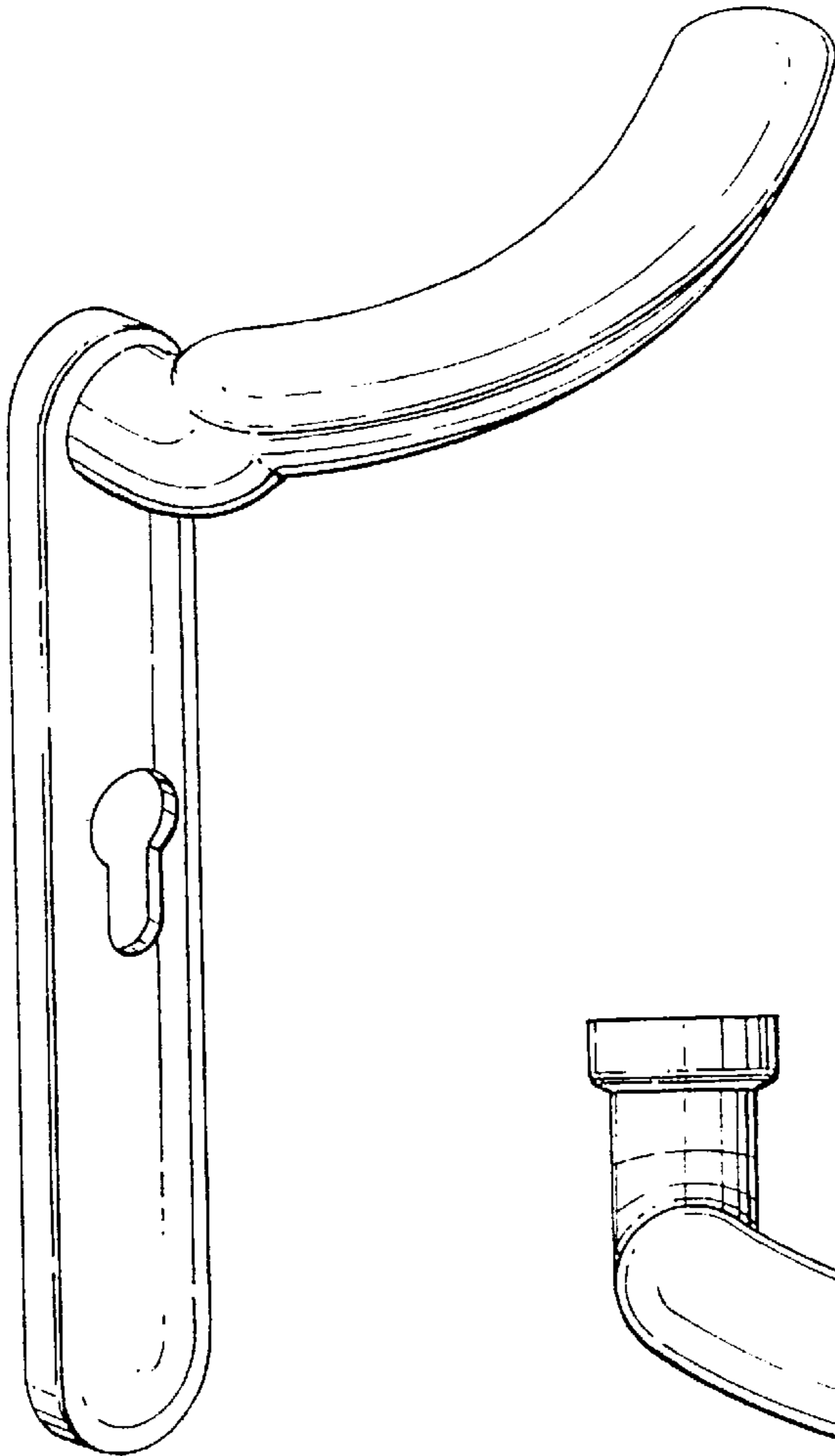

Fig.16.

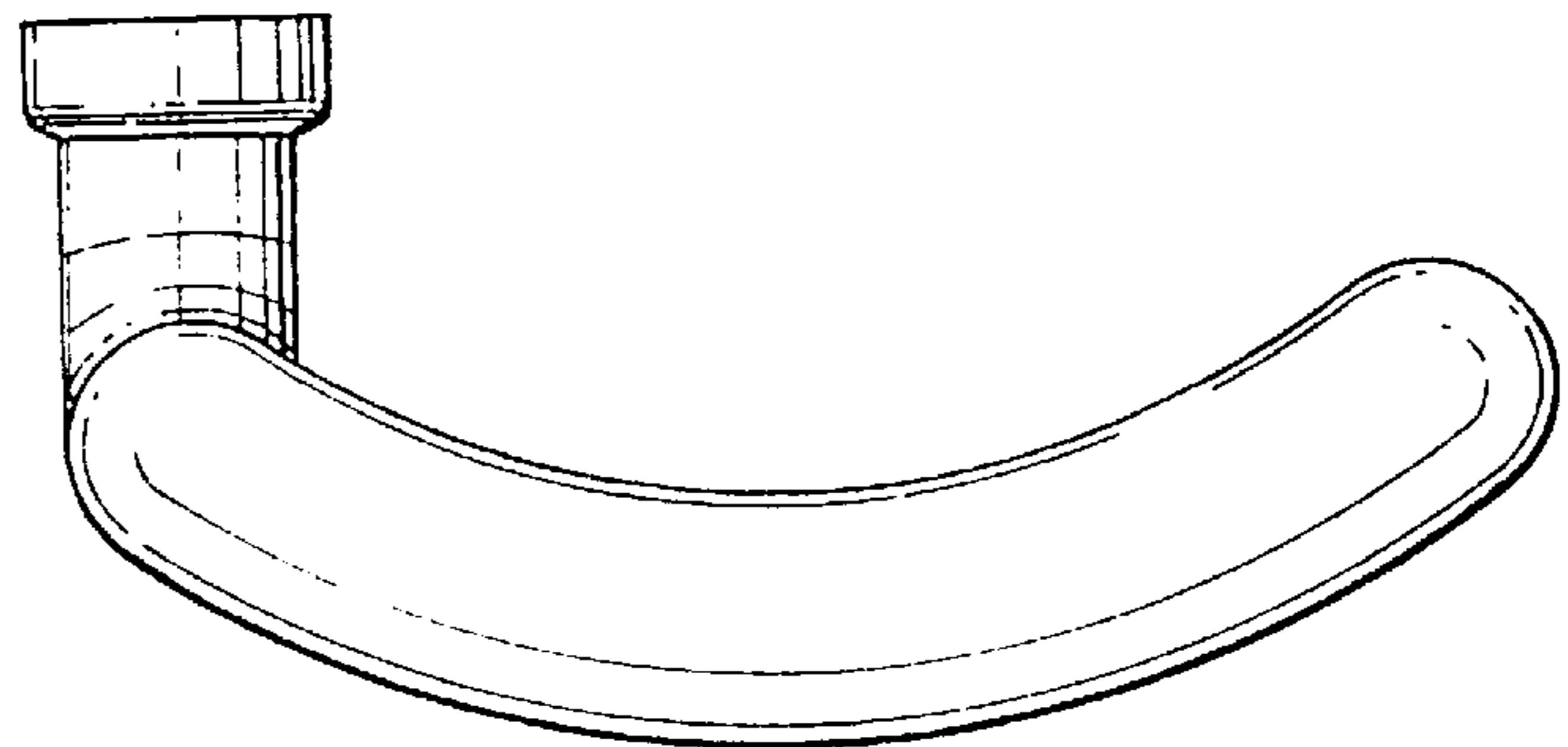

Fig.17.

