



US00D402479S

United States Patent [19]
Inada

[11] **Patent Number: Des. 402,479**

[45] **Date of Patent: **Dec. 15, 1998**

[54] **MESSAGE CHAIR**

[75] Inventor: **Nichimu Inada**, Osaka, Japan

[73] Assignee: **Family Co., Ltd.**, Osaka, Japan

[**] Term: **14 Years**

[21] Appl. No.: **65,658**

[22] Filed: **Jan. 31, 1997**

[51] **LOC (6) Cl.** **06-01**

[52] **U.S. Cl.** **D6/361; D6/367**

[58] **Field of Search** D6/334, 335, 336,
D6/360, 361, 367, 500, 501, 502; 297/68,
377; 601/97-99, 102, 115, 116

[56] **References Cited**

U.S. PATENT DOCUMENTS

D. 167,761	9/1952	Luckhardt	D6/361
D. 206,532	12/1966	Gandella et al.	D6/361
D. 292,350	10/1987	Goldman	D6/361
D. 328,530	8/1992	Pomeroy	D6/367
D. 374,560	10/1996	Fujimoto et al.	D6/367

Primary Examiner—Gary D. Watson

Attorney, Agent, or Firm—Christie, Parker & Hale, LLP

[57] **CLAIM**

The ornamental design for a massage chair, as shown and described.

DESCRIPTION

FIG. 1 is a perspective view of a presently preferred embodiment of the massage chair;
 FIG. 2 is a right side view of the chair of FIG. 1;
 FIG. 3 is a left side view of the chair of FIG. 1;
 FIG. 4 is a front view of the chair of FIG. 1;
 FIG. 5 is a rear view of the chair of FIG. 1;
 FIG. 6 is a top view of the chair of FIG. 1;
 FIG. 7 is a perspective view of an alternate embodiment of the massage chair;
 FIG. 8 is a right side view of the chair of FIG. 7;
 FIG. 9 is a left side view of the chair of FIG. 7;
 FIG. 10 is a front view of the chair of FIG. 7; and,
 FIG. 11 is a rear view of the chair of FIG. 7.
 The broken line showing portions of the chair in FIGS. 7-11 is for illustrative purposes only and forms no part of the claimed design.

1 Claim, 11 Drawing Sheets





Fig. 1

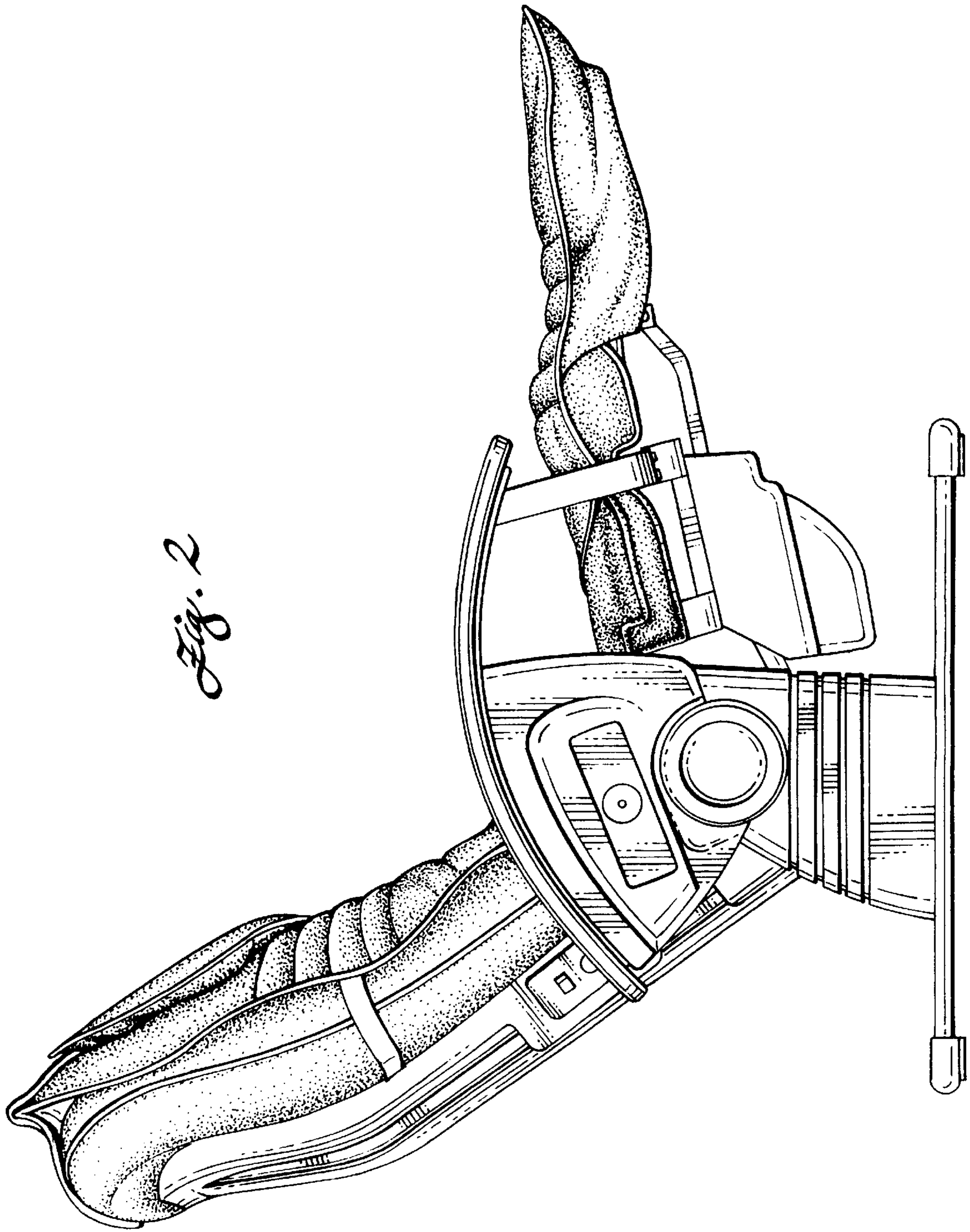

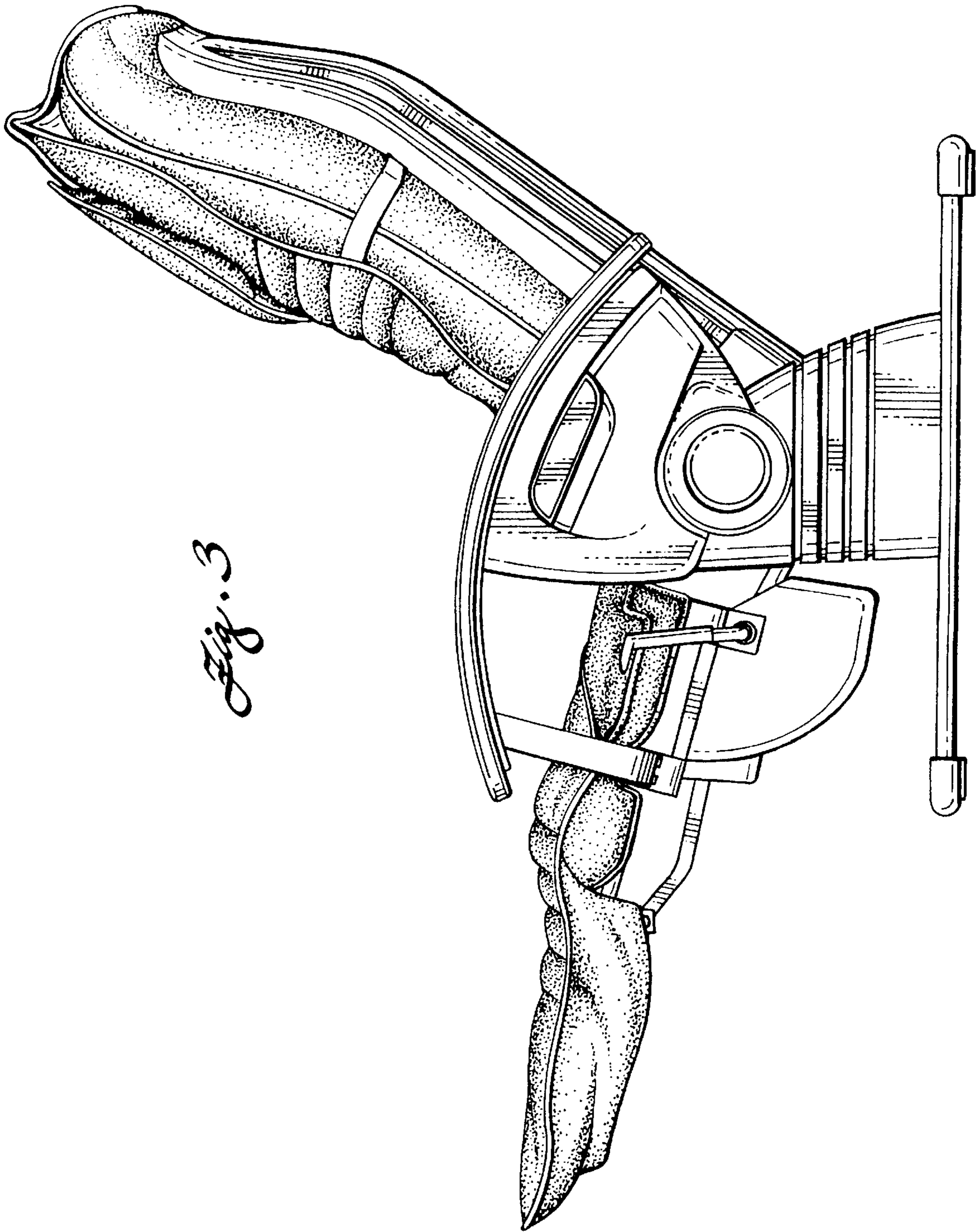

Fig. 3

Fig. A

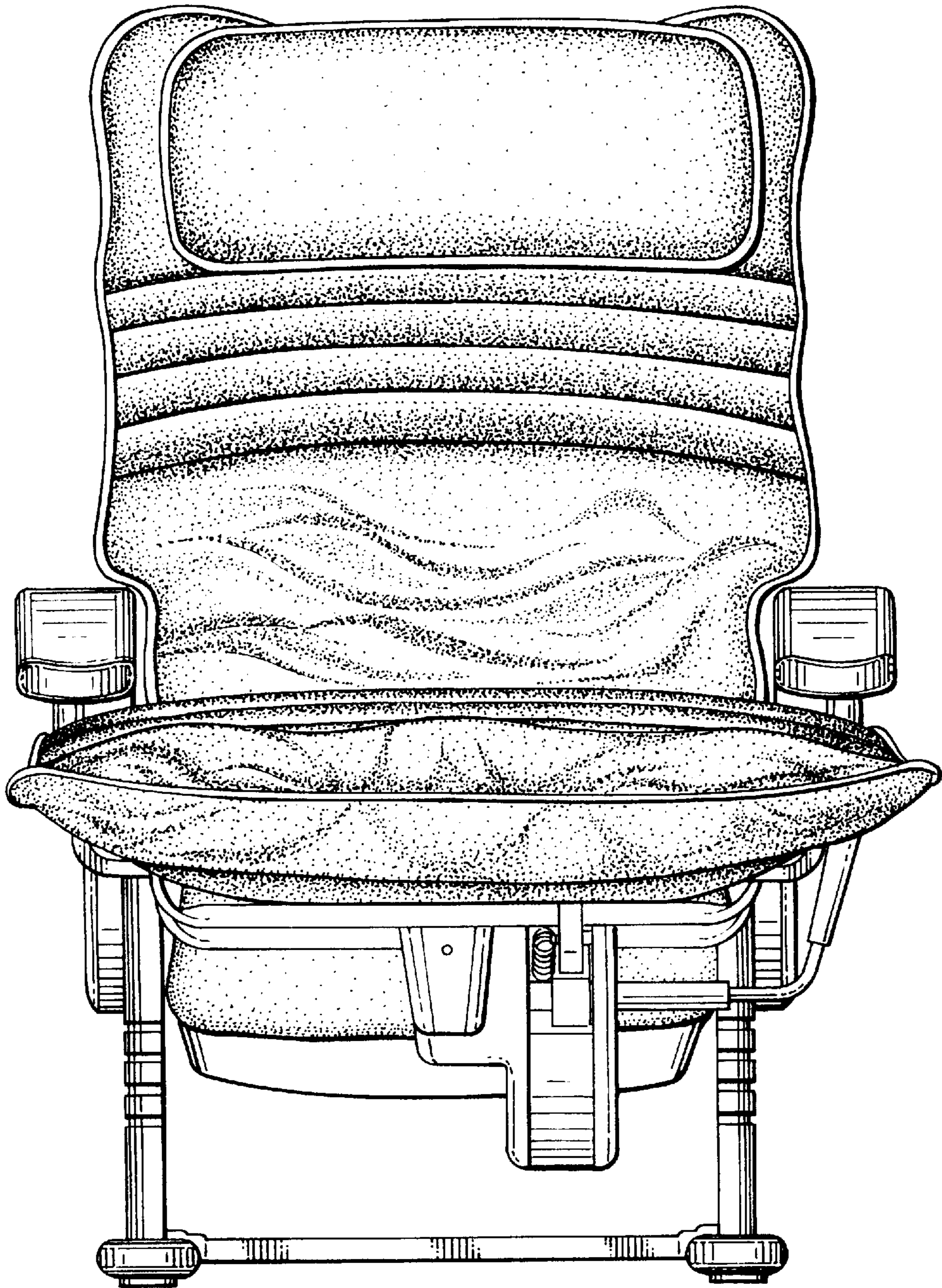

Fig. 5

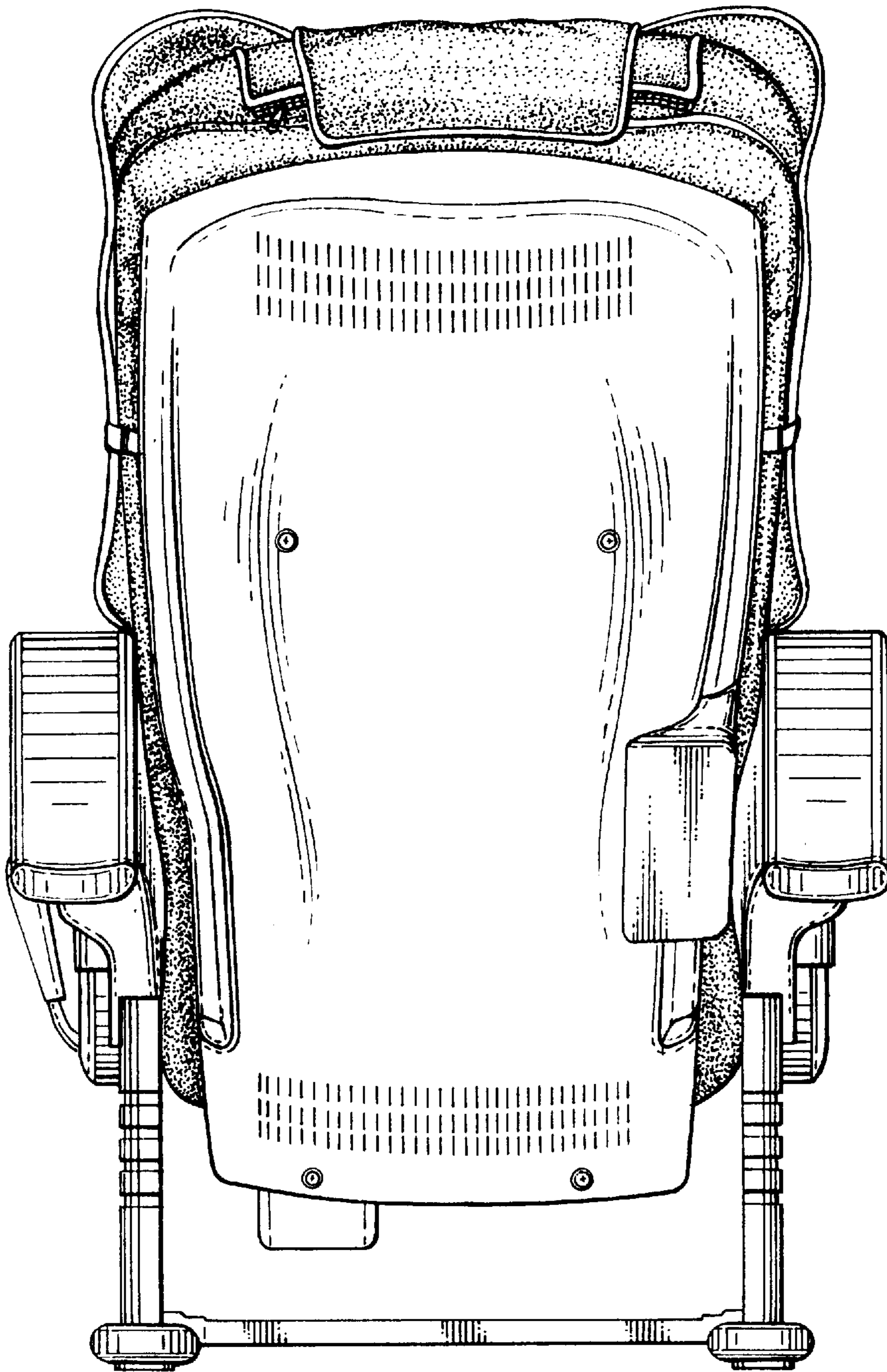
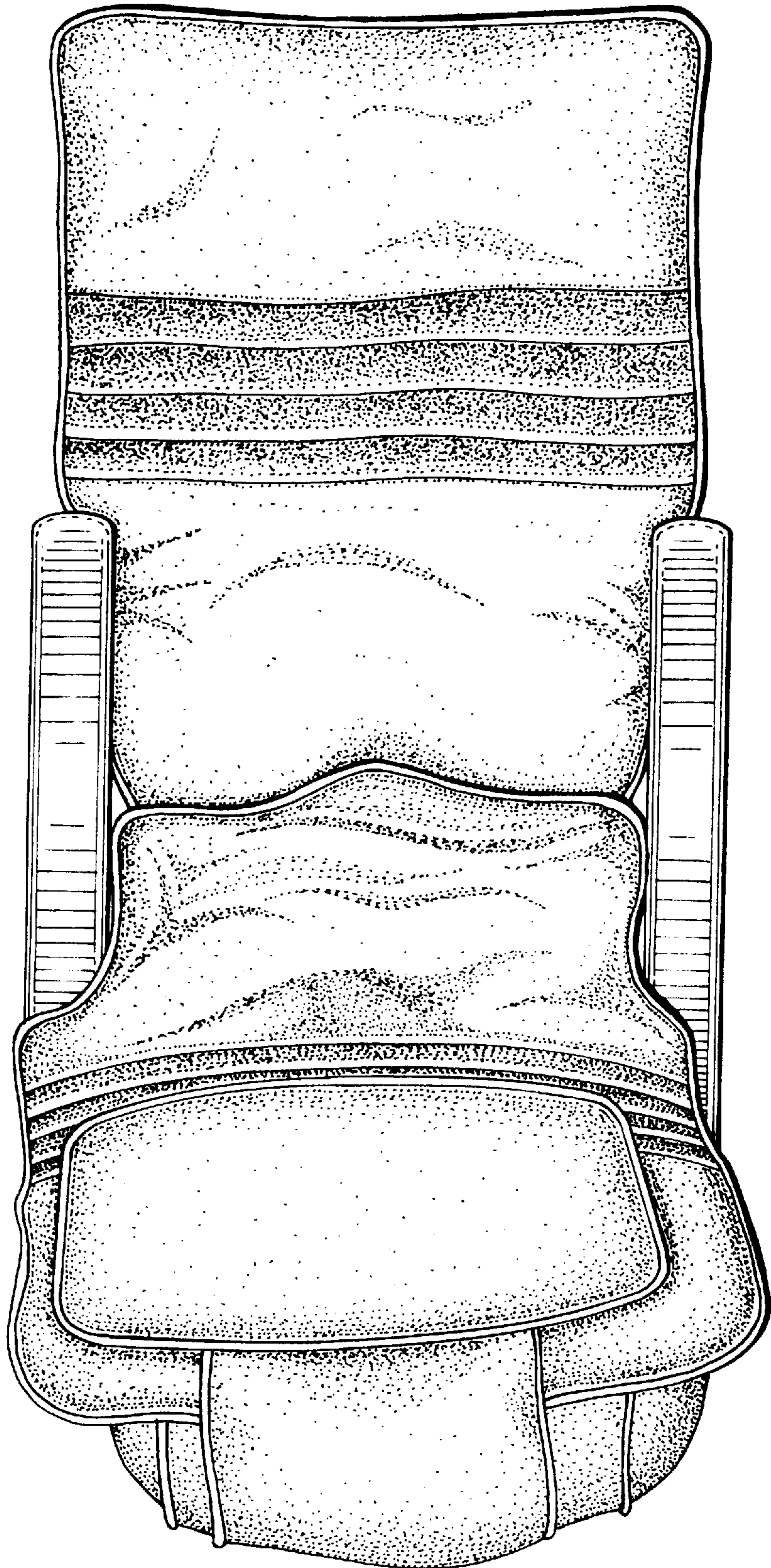

Fig. 6



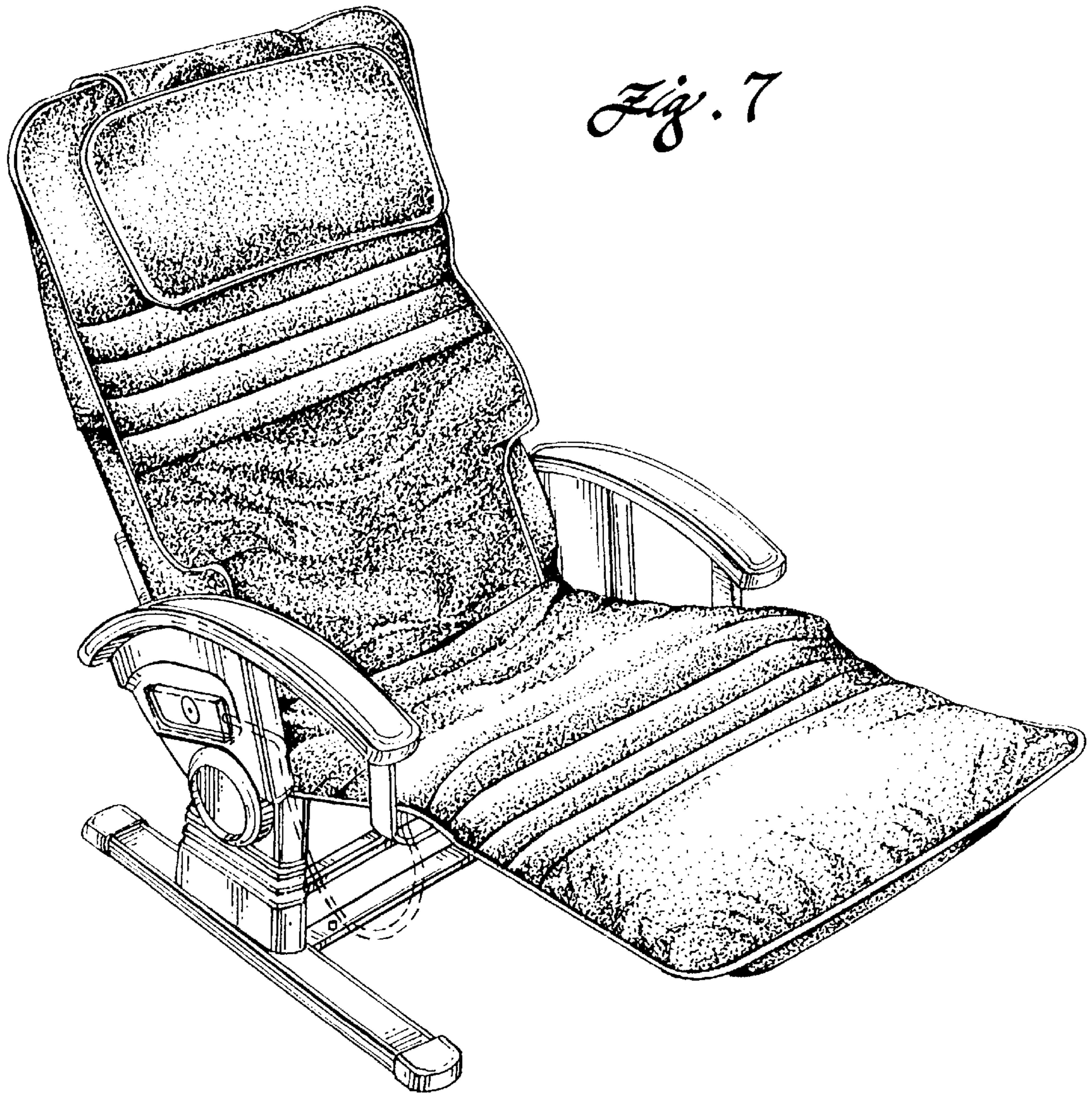
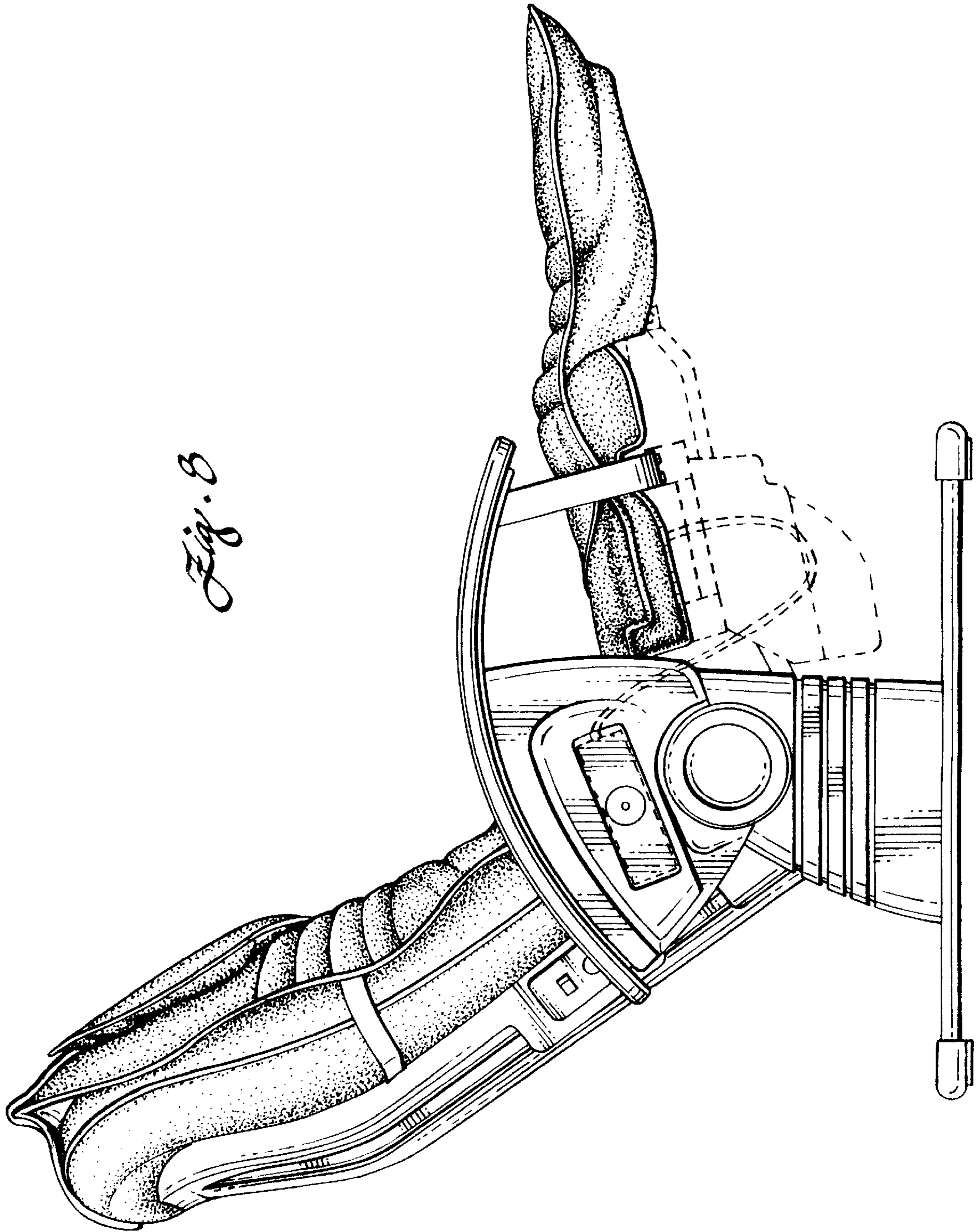

Fig. 7

Fig. 8



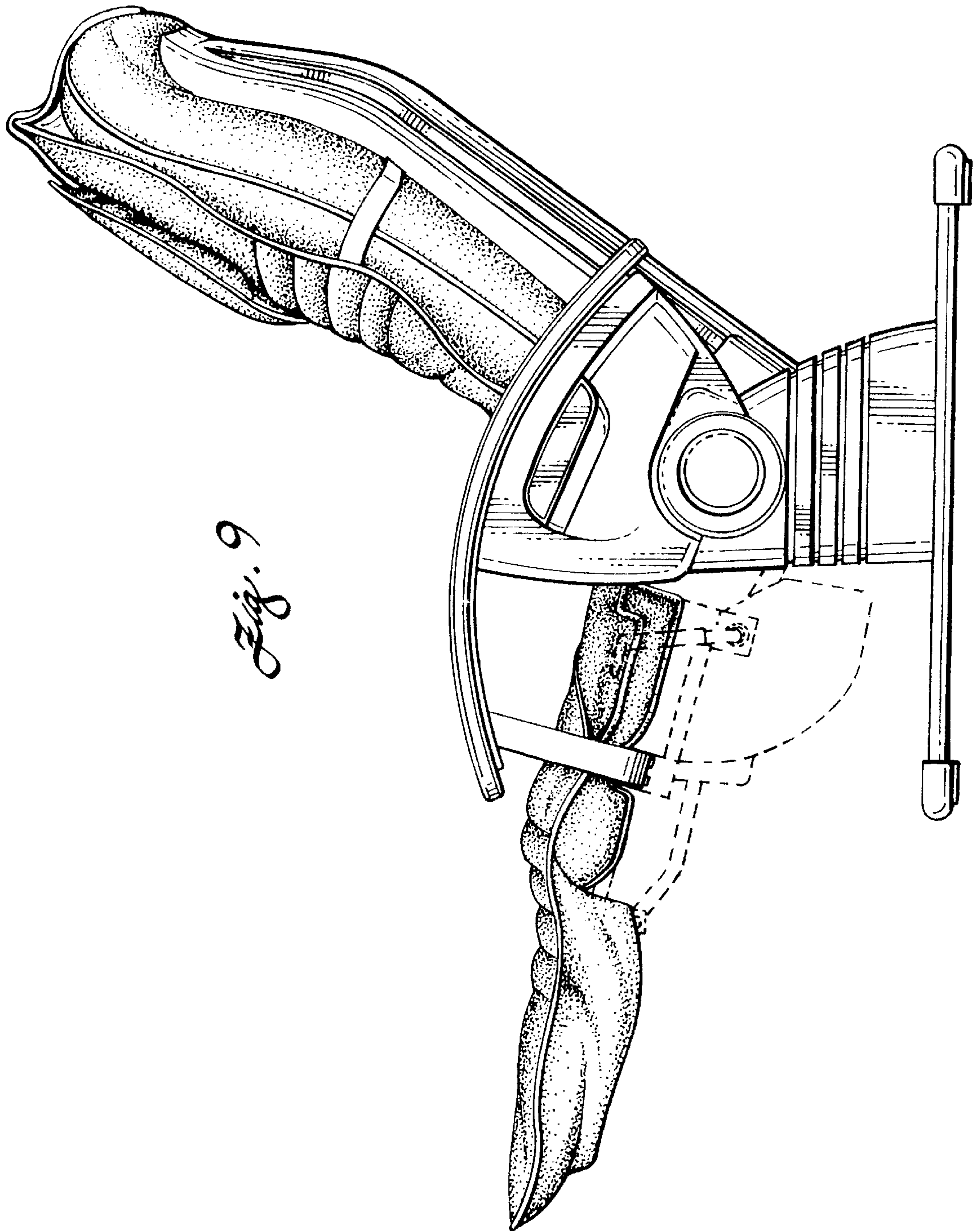

Fig. 9

Fig. 10

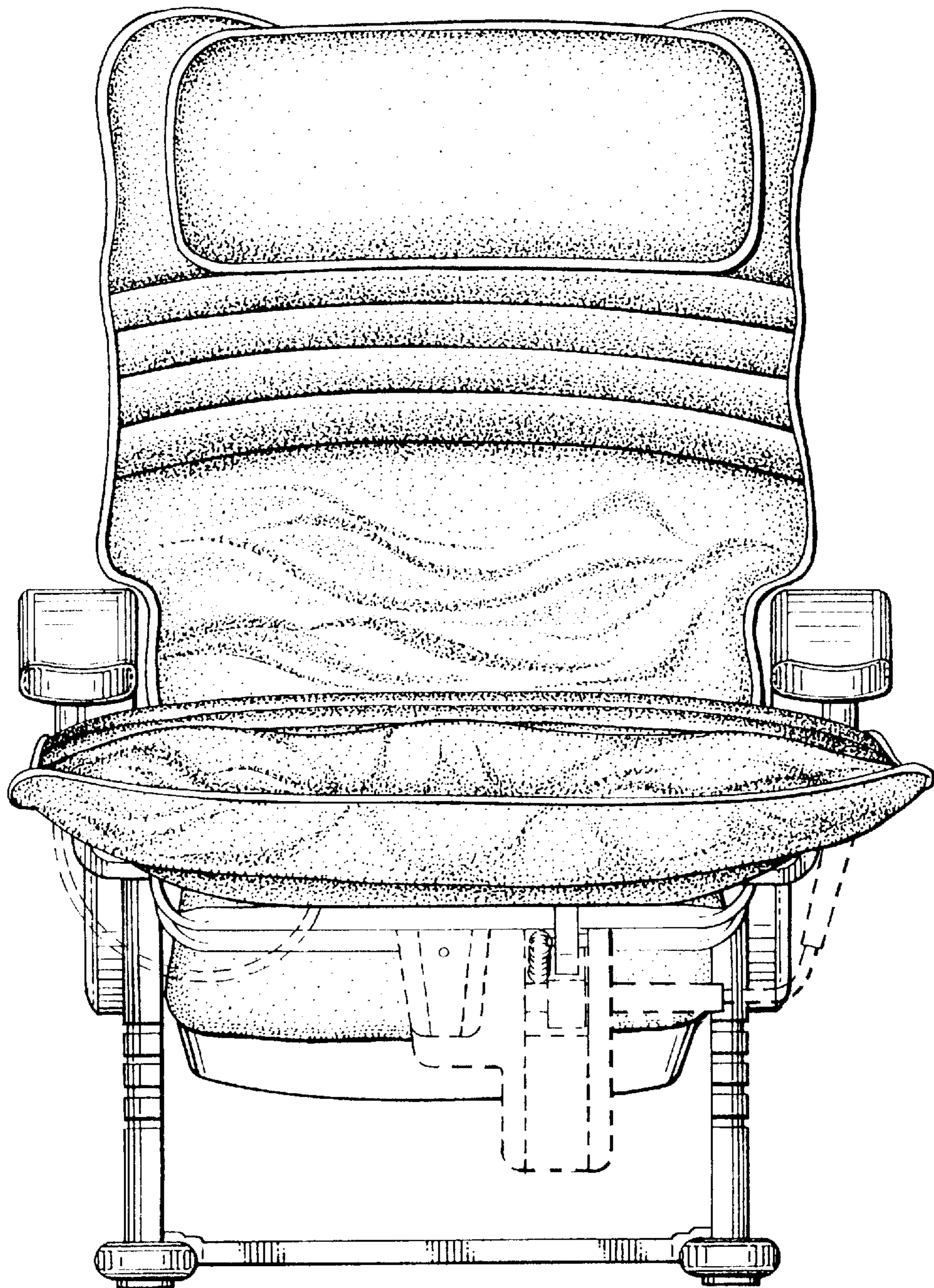

Fig. 11

